

liberi **IN** cucina

# ALPES

Alpes-Inox s.r.l.  
via Monte Pertica, 5  
36061 Bassano del Grappa,  
Vicenza, Italia  
Tel +39 0424 513500  
Fax +39 0424 36634  
info@alpesinox.com  
www.alpesinox.com

Alpes Inox declina ogni  
responsabilità per possibili  
errori o inesattezze.

Si riserva inoltre  
di apportare, in qualsiasi  
momento e senza preavviso,  
modifiche alle caratteristiche  
dei propri prodotti.

I dati forniti non sono  
impegnativi.

Per una corretta installazione  
consultare e attenersi alle  
istruzioni tecniche.

Alpes Inox declines all  
responsibility for any  
mistakes or inaccuracies.

It reserves the right to make  
modifications to its products  
at any time without prior  
notice. The information  
supplied is purely indicative  
and not binding.

For correct installation  
please see and follow the  
technical instructions.

production management  
Alpes ufficio marketing  
agency  
Umbrella, Treviso  
photography  
Miro Zagnoli  
translation  
Olga Barmine, Technolab  
printing  
Chinchio Industria Grafica srl  
print on December 2016  
copyright © Alpes-Inox 2014

5. **70**

---

7. **100**

---

9. **130**

---

11. **160**

---

13. **190**

---

17. **220**

---

19. **250**

---

21. **280**

---

**XYZ**

---

23. **Colonne**  
Columns

27. **Accessori**  
Accessories

28. **Outdoor**  
Outdoor

---

29. **Acciaio inox**  
Stainless steel

30. **Pulizia dei materiali**  
Cleaning the materials

**Top inox**  
S/steel countertop

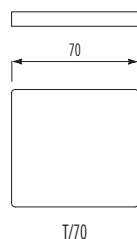

**Top Corian®**  
Corian® countertop

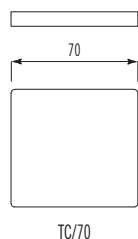

**Top Legno**  
Wooden countertop

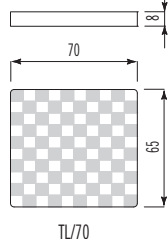

**Fori su top inox**  
Cutout holes on the  
s/steel countertop

**un foro incasso per lavaggio o cottura**  
one built-in hole for washing or cooking items

**un foro incasso filo piano per piani cottura a induzione**  
one built-in hole for flush-mount induction hobs

**un foro e saldatura per lavaggio**  
one hole and welding for washing items

**un foro per piani cottura ribaltabili**  
one hole for flip-up hobs

**Fori su top Corian®**  
Cutout holes on the  
Corian® countertop

**un foro incasso per lavaggio**  
one built-in hole for washing items

**un foro incasso per cottura**  
one built-in hole for cooking items

**un foro per lavaggio o cottura sottopiano o filo piano**  
one hole for an undermount or flush-mount washing or cooking items

**un foro per piani cottura ribaltabili**  
one hole for flip-up hobs

Top ed elettrodomestici non sono inclusi nel prezzo dell'elemento di libera installazione. Per gli elettrodomestici fare riferimento al listino "Strumenti d'Oggi".  
The countertop and the appliances are not included in the price of the freestanding unit. For appliances, please consult the "Strumenti d'Oggi" price-list.

Elemento libero  
Free element

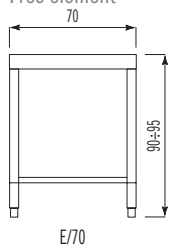

Elemento libero con ripiano fisso  
Free element with fixed shelf

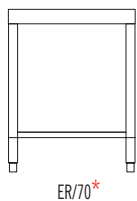

\* L'elemento libero con ripiano fisso è fornito senza fianchi e schienale. The free element with fixed shelf is supplied without sides and back.

Elemento con pannello per lavastoviglie  
Element with dishwasher panel

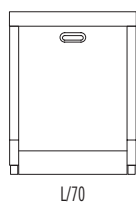

Elemento per frigorifero o cantinetta  
Element for refrigerator or wine cellar

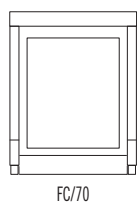

Elemento per forno da 60 cm  
Element for oven 60 cm wide

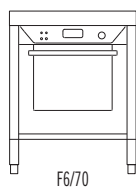

Elemento con anta  
Element with door

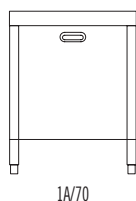

Elementi con cassetti 60 cm  
Elements with drawers 60 cm wide

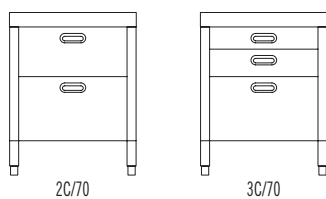

Elementi aperti con ripiani scorrevoli  
Open elements with sliding shelves

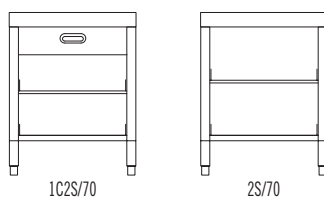

**Top inox**  
S/steel countertop

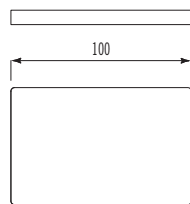

T/100

**Top Corian®**  
Corian® countertop

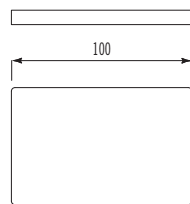

TC/100

**Top legno**  
Wooden countertop

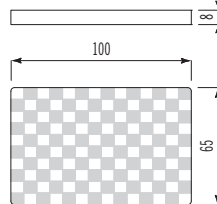

TL/100

**Fori su top inox**  
Cutout holes on the  
s/steel countertop

**un foro incasso per  
lavaggio o cottura**  
one built-in hole for  
washing or cooking items

**un foro incasso filo piano per  
piani cottura a induzione**  
one built-in hole for  
flush-mount induction hobs

**un foro e saldatura per  
lavaggio**  
one hole and welding for  
washing items

**un foro per piani cottura  
ribaltabili**  
one hole for flip-up  
hobs

**Fori su top Corian®**  
Cutout holes on the  
Corian® countertop

**un foro incasso per lavaggio**  
one built-in hole for washing items

**un foro incasso per cottura**  
one built-in hole for cooking items

**un foro per lavaggio o cottura  
sottopiano o filo piano**  
one hole for an undermount or  
flush-mount washing or cooking items

**un foro per piani cottura  
ribaltabili**  
one hole for flip-up hobs

Top ed elettrodomestici non sono inclusi nel prezzo dell'elemento di libera installazione. Per gli elettrodomestici fare riferimento al listino "Strumenti d'Oggi".  
The countertop and the appliances are not included in the price of the freestanding unit. For appliances, please consult the "Strumenti d'Oggi" price-list.

### Elemento libero

Free element

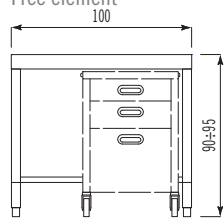

E/100

### Elemento libero con ripiano fisso

Free element with fixing shelf

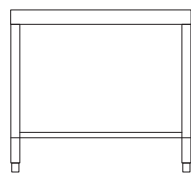

ER/100\*

\* L'elemento libero con ripiano fisso è fornito senza fianchi e schienale. The free element with fixed shelf is supplied without sides and back.

### Elementi per forno da 60 cm

Elements for oven 60 cm wide

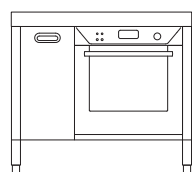

1AF6/100

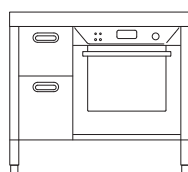

2CF6/100

### Elemento per forno da 90 cm

Element for oven 90 cm wide

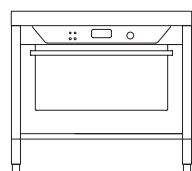

F9/100

### Elemento con ante

Element with doors

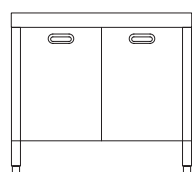

2A/100

### Elementi con cassetti 90 cm

Elements with drawers 90 cm wide

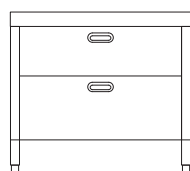

2C/100

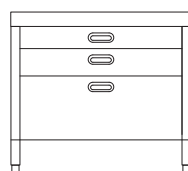

3C/100

### Elemento lavaggio con cassetti 90 cm

Washing element with drawers 90 cm wide

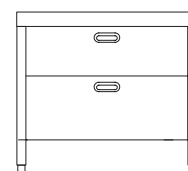

2C-L/100

### Elemento aperto con ripiani scorrevoli 90 cm

Open element with sliding shelves 90 cm wide

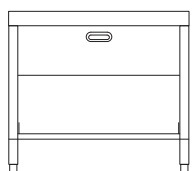

1C1S/100

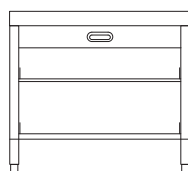

1C2S/100

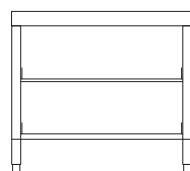

2S/100

**Top inox**  
Stainless steel countertop

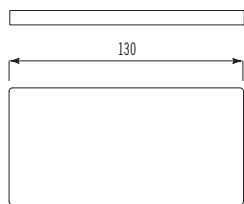

T/130

**Top Corian®**  
Corian® countertop

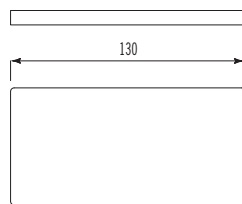

TC/130

**Top legno**  
Wooden countertop

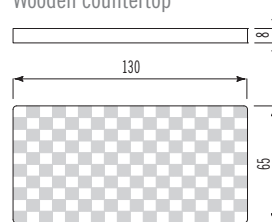

TL/130

**Top inox ad isola**  
Stainless steel island countertop

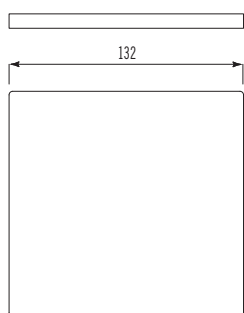

T/130-I

**Top Corian® ad isola**  
Corian® island countertop

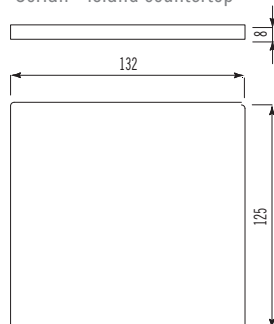

TC/130-I

**Fori su top inox**  
Cutout holes on the stainless steel countertop

**un foro incasso per lavaggio o cottura**  
one built-in hole for washing or cooking items

**un foro incasso filo piano per piani cottura a induzione**  
one built-in hole for flush-mount induction hobs

**un foro e saldatura per lavaggio**  
one hole and welding for washing items

**un foro per piani cottura ribaltabili**  
one hole for flip-up hobs

**Fori su top Corian®**  
Cutout holes on the Corian® countertop

**un foro incasso per lavaggio**  
one built-in hole for washing items

**un foro incasso per cottura**  
one built-in hole for cooking items

**un foro per lavaggio o cottura sottopiano o filo piano**  
one hole for an undermount or flush-mount washing or cooking items

**un foro per piani cottura ribaltabili**  
one hole for flip-up hobs

Top ed elettrodomestici non sono inclusi nel prezzo dell'elemento di libera installazione. Per gli elettrodomestici fare riferimento al listino "Strumenti d'Oggi".  
The countertop and the appliances are not included in the price of the freestanding unit. For appliances, please consult the "Strumenti d'Oggi" price-list.



**Elemento libero**  
Free element

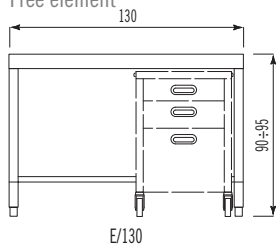

E/130

**Elemento libero con ripiano fisso**  
Free element with fixed shelf

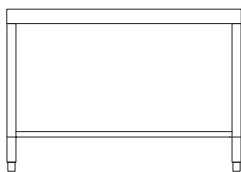

ER/130\*

\* L'elemento libero con ripiano fisso è fornito senza fianchi e schienale. The free element with fixed shelf is supplied without sides and back.

**Elemento con pannello per lavastoviglie**  
Element with dishwasher panel

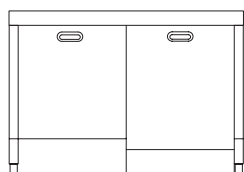

1AL/130

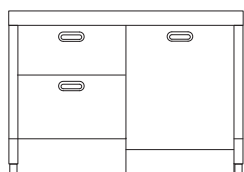

2CL/130

**Elemento libero per due cantinette**  
Free element for two wine cellars

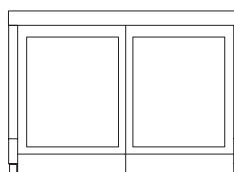

E/130-2FC

**Elementi per forno da 60 cm**  
Elements for oven 60 cm wide

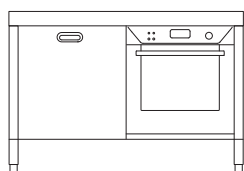

1AF6/130

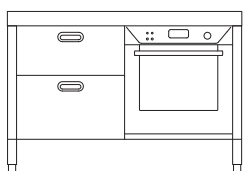

2CF6/130

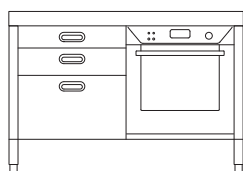

3CF6/130

**Elementi per forno da 90 cm**  
Elements for oven 90 cm wide

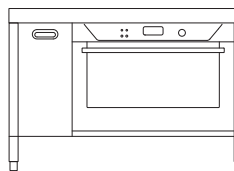

1AF9/130

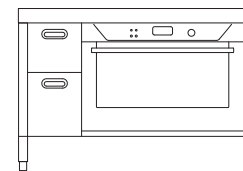

2CF9/130

**Elemento con ante**  
Element with doors

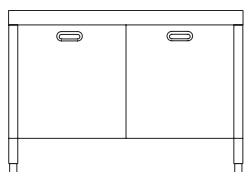

2A/130

**Elementi con cassetti 60 cm**  
Elements with drawers 60 cm wide

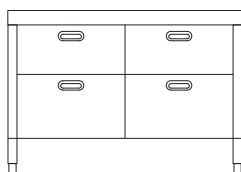

4C/130

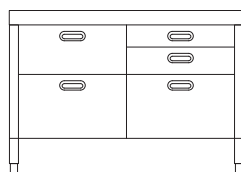

5C/130

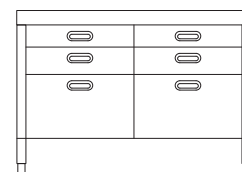

6C/130

**Elementi con cassetti 120 cm**  
Elements with drawers 120 cm wide

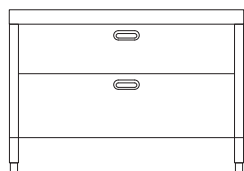

2C/130

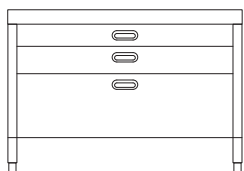

3C/130

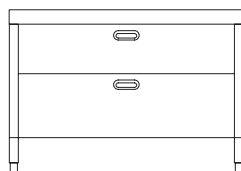

2C-L/130

**Elemento lavaggio con cassetti 120 cm**  
Washing element with drawers 120 cm wide

**Elemento aperto con ripiani scorrevoli 120 cm**  
Open element with sliding shelves 120 cm wide

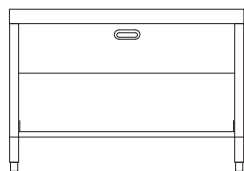

1C1S/130

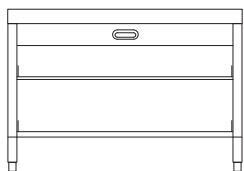

1C2S/130

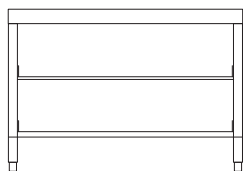

2S/130

**Top inox**  
Stainless steel countertop

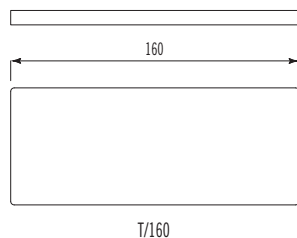

**Top Corian®**  
Corian® countertop

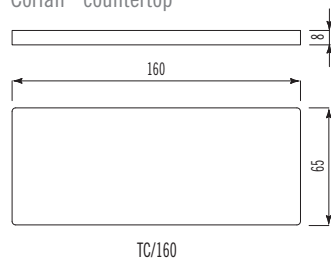

**Top inox ad isola**  
Stainless steel island countertop

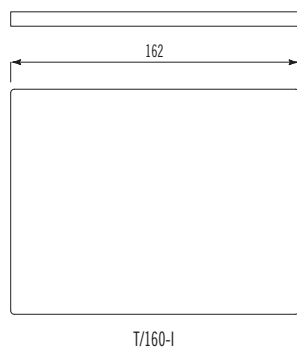

**Top Corian® ad isola**  
Corian® island countertop

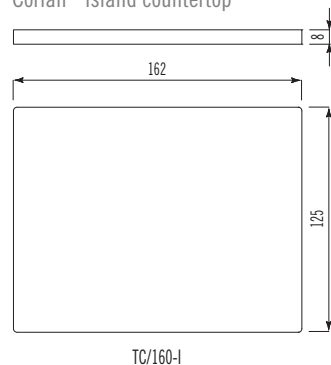

**Fori su top inox**  
Cutout holes on the stainless steel countertop

**un foro incasso per lavaggio o cottura**  
one built-in hole for washing or cooking items

**un foro incasso filo piano per piani cottura a induzione**  
one built-in hole for flush-mount induction hobs

**un foro e saldatura per lavaggio**  
one hole and welding for washing items

**un foro per piani cottura ribaltabili**  
one hole for flip-up hobs

**Fori su top Corian®**  
Cutout holes on the Corian® countertop

**un foro incasso per lavaggio**  
one built-in hole for washing items

**un foro incasso per cottura**  
one built-in hole for cooking items

**un foro per lavaggio o cottura sottopiano o filo piano**  
one hole for an undermount or flush-mount washing or cooking items

**un foro per piani cottura ribaltabili**  
one hole for flip-up hobs

Top ed elettrodomestici non sono inclusi nel prezzo dell'elemento di libera installazione. Per gli elettrodomestici fare riferimento al listino "Strumenti d'Oggi".  
The countertop and the appliances are not included in the price of the freestanding unit. For appliances, please consult the "Strumenti d'Oggi" price-list.

**Elemento libero**  
Free element

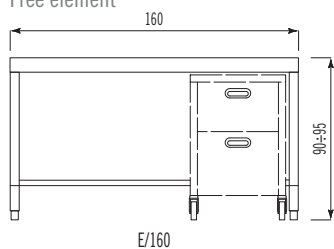

**Elemento libero con ripiano fisso**  
Free element with fixed shelf



\* L'elemento libero con ripiano fisso è fornito senza fianchi e schienale.  
The free element with fixed shelf is supplied without sides and back.

**Elementi con pannello per lavastoviglie**  
Elements with dishwasher panel

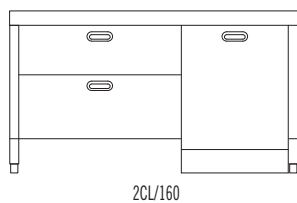
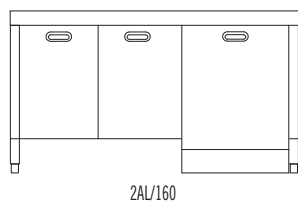

**Elementi per forno da 60 cm**  
Elements for oven 60 cm wide

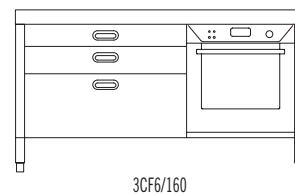
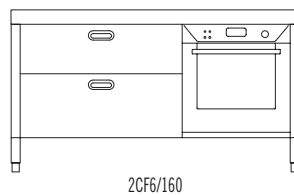
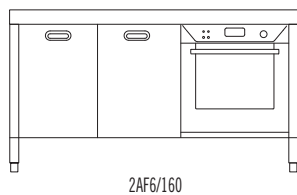
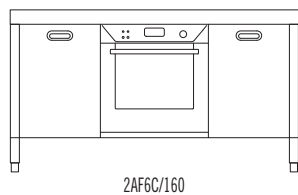

**Elementi per forno da 90 cm**  
Elements for oven 90 cm wide

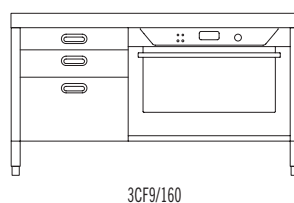
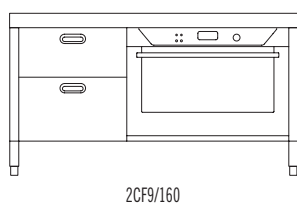
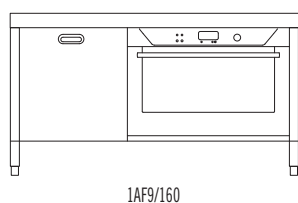

**Elementi con cassetti 60-90 cm**  
Elements with drawers 60-90 cm wide

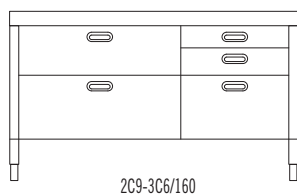
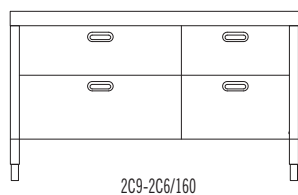

**Elemento aperto con ripiani scorrevoli 60-90 cm**  
Open element with sliding shelves 60-90 cm wide

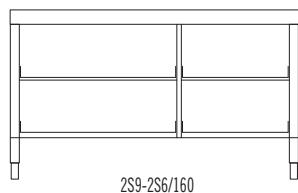

**Top inox**  
Stainless steel countertop

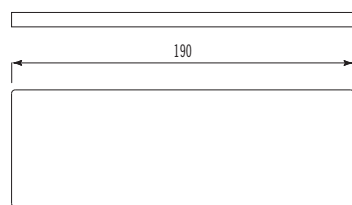

T/190

**Top Corian®**  
Corian® countertop

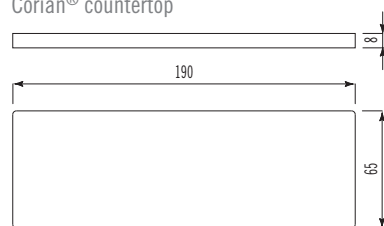

TC/190

**Top inox ad isola**  
Stainless steel island countertop

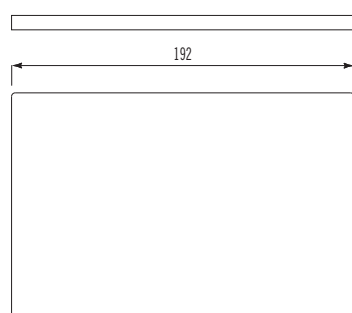

T/190-I

**Top Corian® ad isola**  
Corian® island countertop

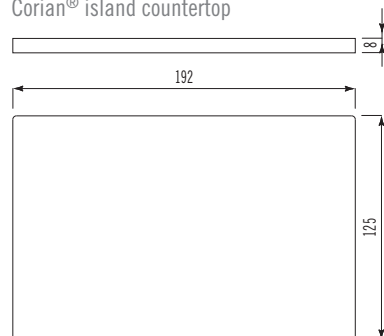

TC/190-I

**Fori su top inox**  
Cutout holes on the  
stainless steel countertop

**un foro incasso per lavaggio o cottura**  
one built-in hole for washing or cooking items

**un foro incasso filo piano per piani cottura a induzione**  
one built-in hole for flush-mount induction hobs

**un foro e saldatura per lavaggio**  
one hole and welding for washing items

**un foro per piani cottura ribaltabili**  
one hole for flip-up hobs

**Fori su top Corian®**  
Cutout holes on the  
Corian® countertop

**un foro incasso per lavaggio**  
one built-in hole for washing items

**un foro incasso per cottura**  
one built-in hole for cooking items

**un foro per lavaggio o cottura sottopiano o filo piano**  
one hole for an undermount or flush-mount washing or cooking items

**un foro per piani cottura ribaltabili**  
one hole for flip-up hobs

Top ed elettrodomestici non sono inclusi nel prezzo dell'elemento di libera installazione. Per gli elettrodomestici fare riferimento al listino "Strumenti d'Oggi".  
The countertop and the appliances are not included in the price of the freestanding unit. For appliances, please consult the "Strumenti d'Oggi" price-list.

Elemento libero  
Free element

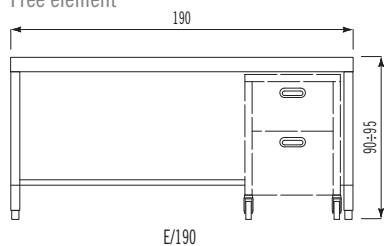

Elemento libero con ripiano fisso  
Free element with fixed shelf



\* L'elemento libero con ripiano fisso è fornito senza fianchi e schienale. The free element with fixed shelf is supplied without sides and back.

Elementi con pannello per lavastoviglie  
Elements with dishwasher panel

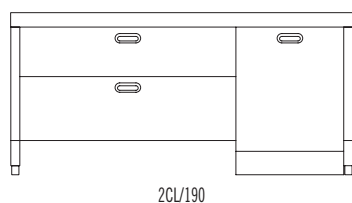
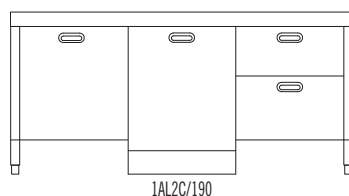
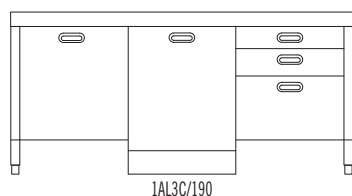
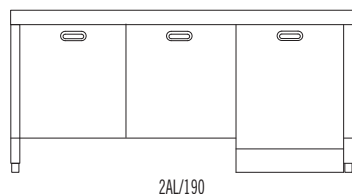

Elemento con pannello per lavastoviglie e forno da 60 cm  
Element with dishwasher panel and oven 60 cm wide

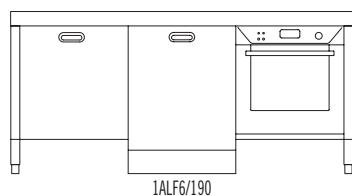

Elementi per forno da 60 cm  
Elements for oven 60 cm wide

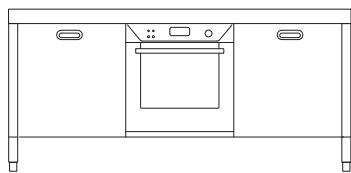

2AF6C/190

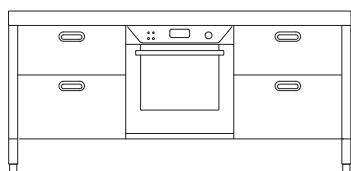

4CF6C/190

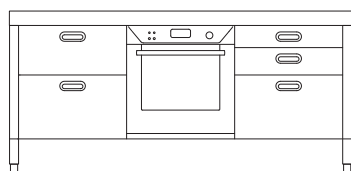

5CF6C/190

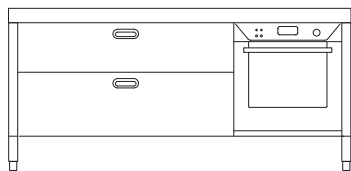

2CF6/190

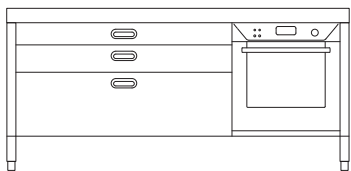

3CF6/190

Elementi per forno da 90 cm  
Elements for oven 90 cm wide

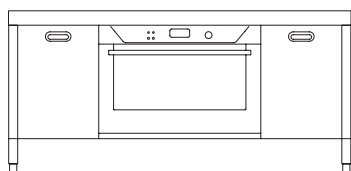

2AF9C/190

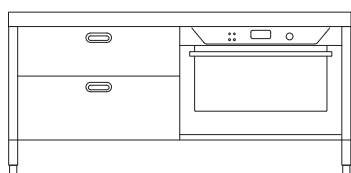

2CF9/190

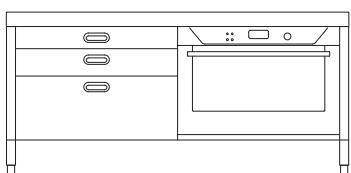

3CF9/190

**Elemento con ante**  
Element with doors

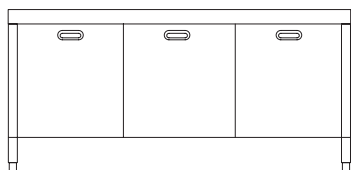

3A/190

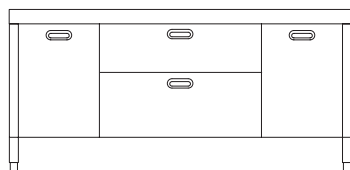

2A2C9/190

**Elementi con cassetti 60 cm**  
Elements with drawers 60 cm wide

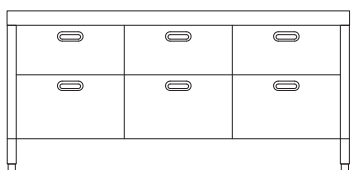

6C6/190

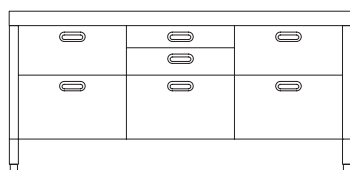

7C/190

**Elementi con cassetti 60-120 cm**  
Elements with drawers 60-120 cm wide

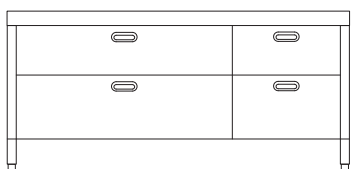

2C12-2C6/190

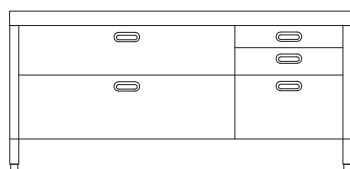

2C12-3C6/190

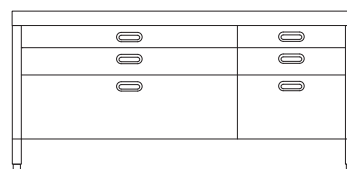

3C12-3C6/190

**Elementi con cassetti 90 cm**  
Elements with drawers 90 cm wide

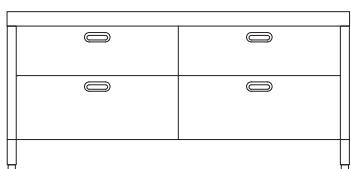

4C/190

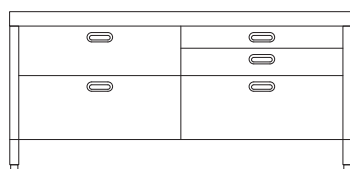

5C/190

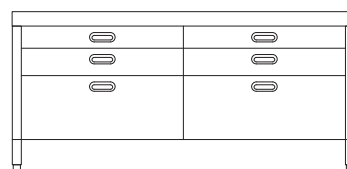

6C/190

**Elemento aperto con cassetti 90 cm e ripiano fisso**  
Open element with drawers 90 cm wide and fixed shelf

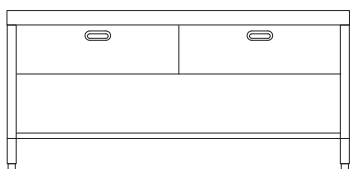

2C1R/190

**Elementi aperti con cassetti e ripiani scorrevoli 90 cm**  
Open elements with drawers and sliding shelves 90 cm wide

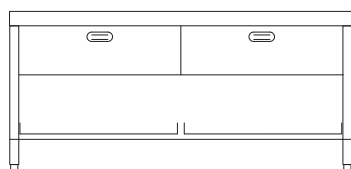

2C2S/190

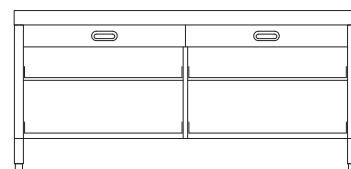

2C4S/190

**Elemento aperto con ripiani scorrevoli 60 cm**  
Open element with sliding shelves 60 cm wide

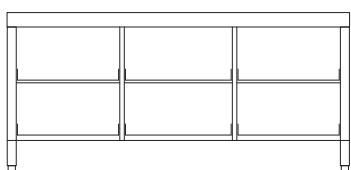

6S/190

**Elemento aperto con ripiani scorrevoli 90 cm**  
Open element with sliding shelves 90 cm wide

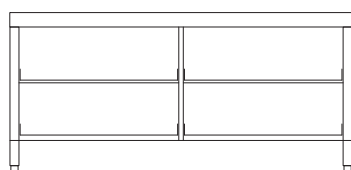

4S/190

**Top inox**  
Stainless steel countertop

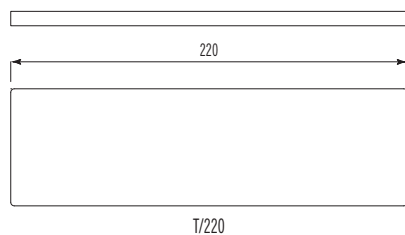

T/220

**Top Corian®**  
Corian® countertop

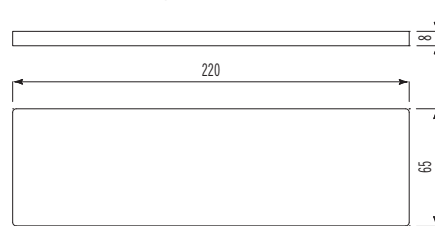

TC/220

**Top inox ad isola**  
Stainless steel island countertop



T/220-I

**Top Corian® ad isola**  
Corian® island countertop

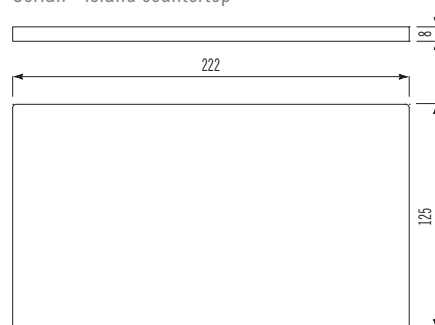

TC/220-I

**Fori su top inox**  
Cutout holes on the  
stainless steel countertop

**un foro incasso per  
lavaggio o cottura**  
one built-in hole for  
washing or cooking items

**un foro incasso filo piano per  
piani cottura a induzione**  
one built-in hole for  
flush-mount induction hobs

**un foro e saldatura per  
lavaggio**  
one hole and welding for  
washing items

**un foro per piani cottura  
ribaltabili**  
one hole for flip-up  
hobs

**Fori su top Corian®**  
Cutout holes on the  
Corian® countertop

**un foro incasso per lavaggio**  
one built-in hole for washing items

**un foro incasso per cottura**  
one built-in hole for cooking items

**un foro per lavaggio o cottura  
sottopiano o filo piano**  
one hole for an undermount or  
flush-mount washing or cooking items

**un foro per piani cottura  
ribaltabili**  
one hole for flip-up hobs

Top ed elettrodomestici non sono inclusi nel prezzo dell'elemento di libera installazione. Per gli elettrodomestici fare riferimento al listino "Strumenti d'Oggi".  
The countertop and the appliances are not included in the price of the freestanding unit. For appliances, please consult the "Strumenti d'Oggi" price-list.



**Elementi con pannello per lavastoviglie**  
Elements with dishwasher panel

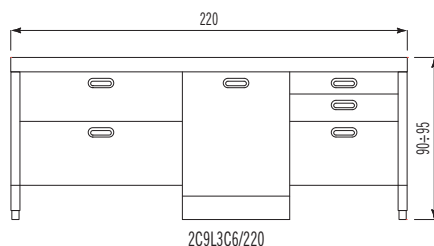
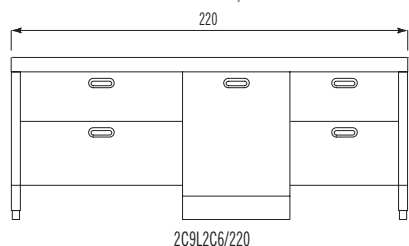

**Elemento con pannello per lavastoviglie e forno da 60 cm**  
Element with dishwasher panel and oven 60 cm wide

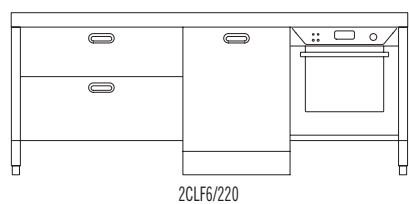

**Elemento con pannello per lavastoviglie e forno da 90 cm**  
Element with dishwasher panel and oven 90 cm wide

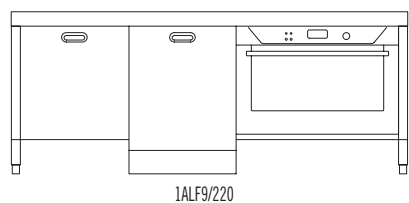

**Elemento per forno da 90 cm**  
Element for oven 90 cm wide

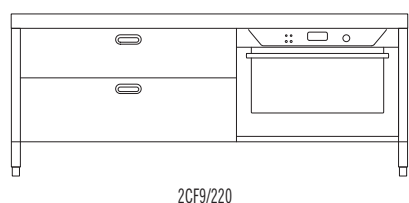

**Elemento con cassetti 90-120 cm**  
Element with drawers 90-120 cm wide

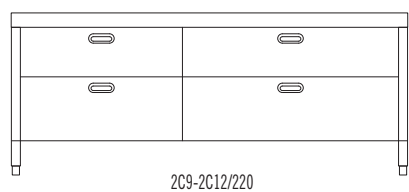

**Elemento con cassetti 60-90 cm**  
Element with drawers 60-90 cm wide

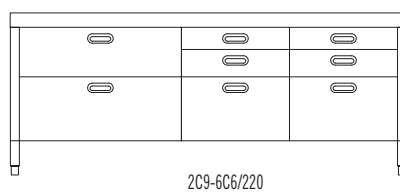

**Elemento aperto con ripiani scorrevoli 90 e 120 cm**  
Open element with sliding shelves 90 and 120 cm wide

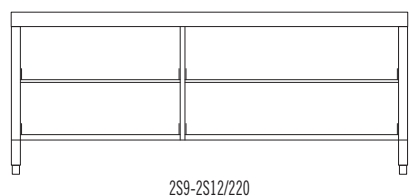

**Elemento aperto con ripiani scorrevoli 90 cm e cassetti 30 cm**  
Open element with sliding shelves 90 cm and drawers 30 cm wide

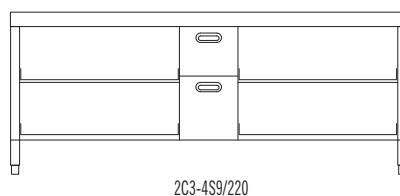

**Top inox**  
Stainless steel countertop

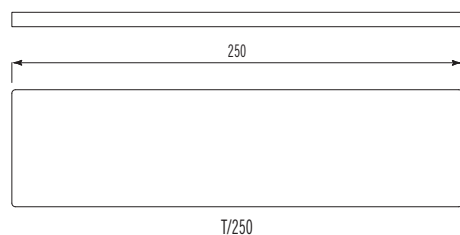

T/250

**Top Corian®**  
Corian® countertop

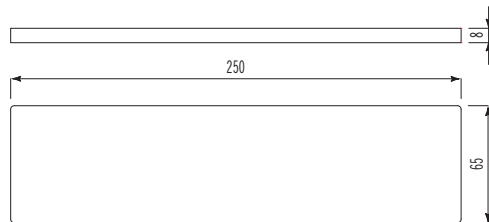

TC/250

**Top inox ad isola**  
Stainless steel island countertop

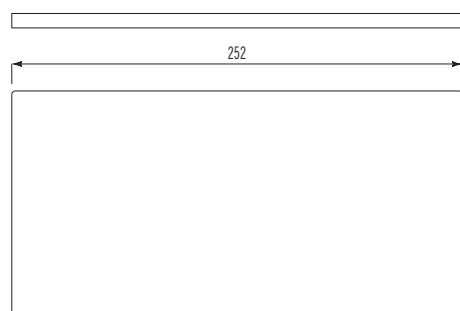

T/250-I

**Top Corian® ad isola**  
Corian® island countertop

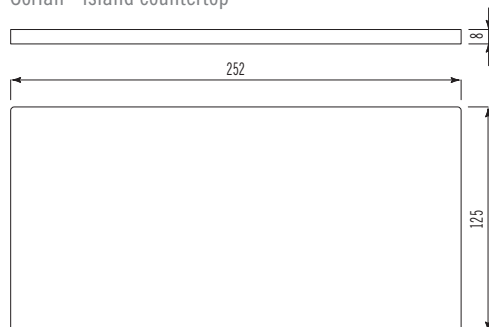

TC/250-I

**Fori su top inox**  
Cutout holes on the  
stainless steel countertop

**un foro incasso per lavaggio o cottura**  
one built-in hole for washing or cooking items

**un foro incasso filo piano per piani cottura a induzione**  
one built-in hole for flush-mount induction hobs

**un foro e saldatura per lavaggio**  
one hole and welding for washing items

**un foro per piani cottura ribaltabili**  
one hole for flip-up hobs

**Fori su top Corian®**  
Cutout holes on the  
Corian® countertop

**un foro incasso per lavaggio**  
one built-in hole for washing items

**un foro incasso per cottura**  
one built-in hole for cooking items

**un foro per lavaggio o cottura sottopiano o filo piano**  
one hole for an undermount or flush-mount washing or cooking items

**un foro per piani cottura ribaltabili**  
one hole for flip-up hobs

Top ed elettrodomestici non sono inclusi nel prezzo dell'elemento di libera installazione. Per gli elettrodomestici fare riferimento al listino "Strumenti d'Oggi".  
The countertop and the appliances are not included in the price of the freestanding unit. For appliances, please consult the "Strumenti d'Oggi" price-list.

**Elemento con pannello per lavastoviglie**  
Element with dishwasher panel

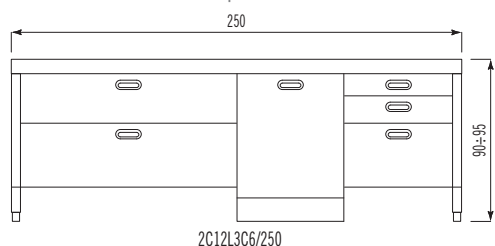

**Elemento con pannello per lavastoviglie e forno da 60 cm**  
Element with dishwasher panel and oven 60 cm wide

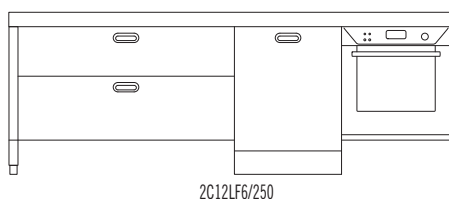

**Elemento con pannello per lavastoviglie e forno da 90 cm**  
Element with dishwasher panel and oven 90 cm wide

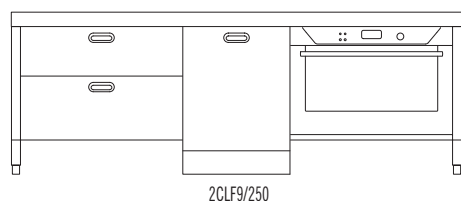

**Elemento con ante**  
Element with doors

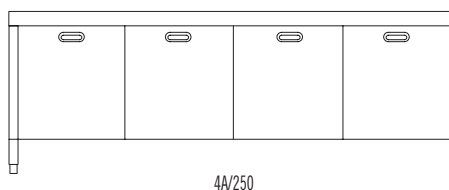

**Elemento con cassetti 60 cm**  
Element with drawers 60 cm wide

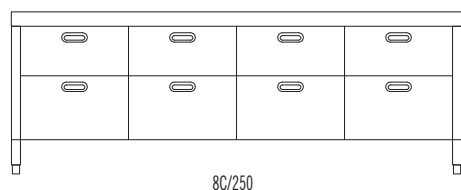

**Elementi con cassetti 60-90 cm**  
Elements with drawers 60-90 cm wide

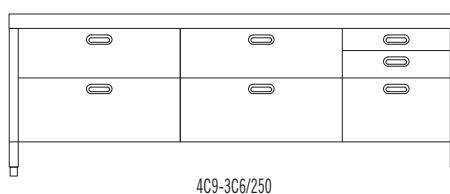

**Elementi con cassetti 120 cm**  
Elements with drawers 120 cm wide

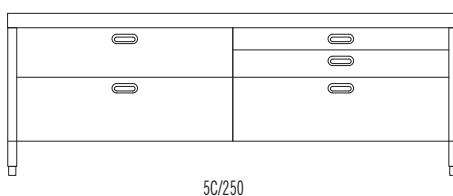

**Elemento aperto con cassetti 120 cm e ripiano fisso**  
Open element with drawers 120 cm wide and fixed shelf

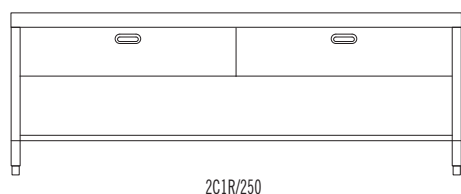

**Elementi aperti con cassetti e ripiani scorrevoli 120 cm**  
Open elements with drawers and sliding shelves 120 cm wide

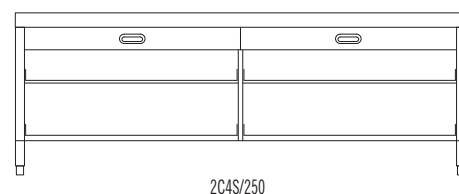
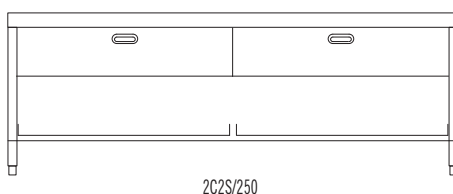

**Elemento aperto con ripiani scorrevoli 120 cm**  
Open element with sliding shelves 120 cm wide

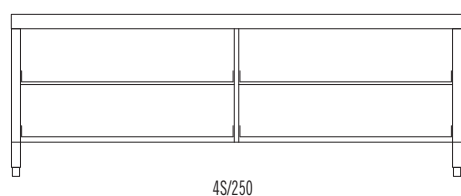

**Top inox**  
Stainless steel countertop

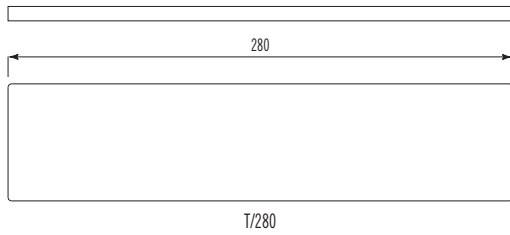

**Top Corian®**  
Corian® countertop

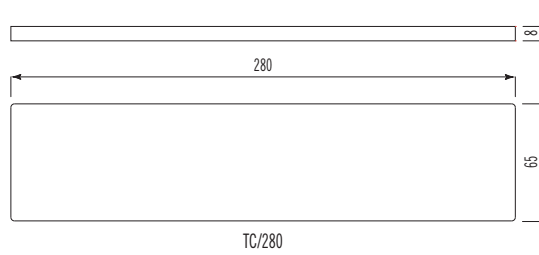

**Top inox ad isola**  
Stainless steel island countertop

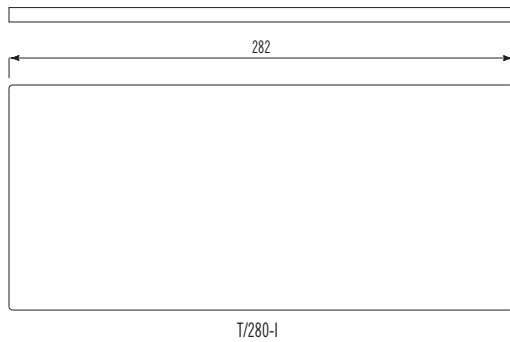

**Top Corian® ad isola**  
Corian® island countertop

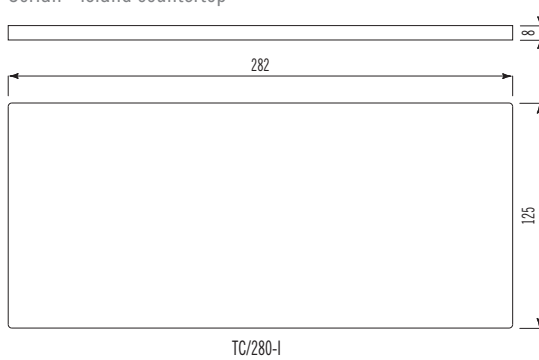

**Fori su top inox**  
Cutout holes on the  
stainless steel countertop

**un foro incasso per lavaggio o cottura**  
one built-in hole for washing or cooking items

**un foro incasso filo piano per piani cottura a induzione**  
one built-in hole for flush-mount induction hobs

**un foro e saldatura per lavaggio**  
one hole and welding for washing items

**un foro per piani cottura ribaltabili**  
one hole for flip-up hobs

**Fori su top Corian®**  
Cutout holes on the  
Corian® countertop

**un foro incasso per lavaggio**  
one built-in hole for washing items

**un foro incasso per cottura**  
one built-in hole for cooking items

**un foro per lavaggio o cottura sottopiano o filo piano**  
one hole for an undermount or flush-mount washing or cooking items

**un foro per piani cottura ribaltabili**  
one hole for flip-up hobs

Top ed elettrodomestici non sono inclusi nel prezzo dell'elemento di libera installazione. Per gli elettrodomestici fare riferimento al listino "Strumenti d'Oggi".  
The countertop and the appliances are not included in the price of the freestanding unit. For appliances, please consult the "Strumenti d'Oggi" price-list.

**Elemento con pannello per lavastoviglie e forno da 60 cm**  
 Element with dishwasher panel and oven 60 cm wide

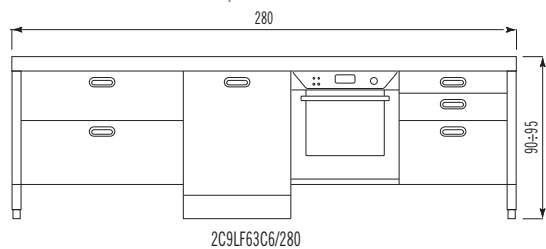

**Elemento con pannello per lavastoviglie e forno da 90 cm**  
 Element with dishwasher panel and oven 90 cm wide

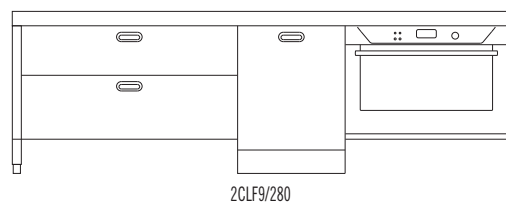

**Elemento per forno da 60 cm**  
 Element for oven 60 cm wide

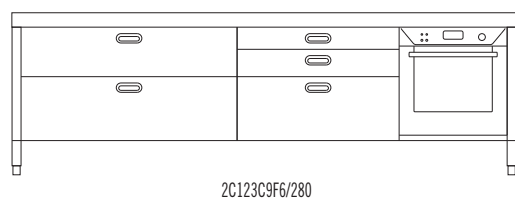

**Elemento per forno da 90 cm**  
 Element for oven 90 cm wide

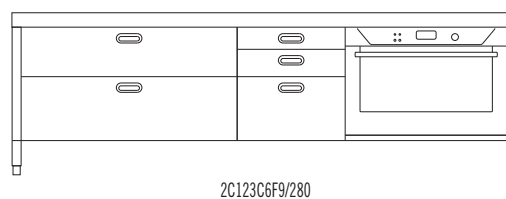

**Elemento con cassetti 60-90-120 cm**  
 Element with drawers 60-90-120 cm wide

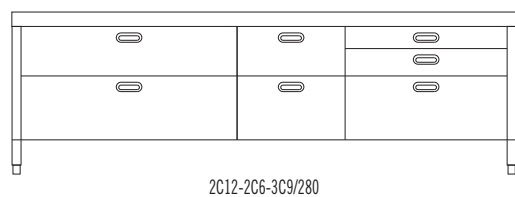

**Elemento con cassetti 90 cm**  
 Element with drawers 90 cm wide

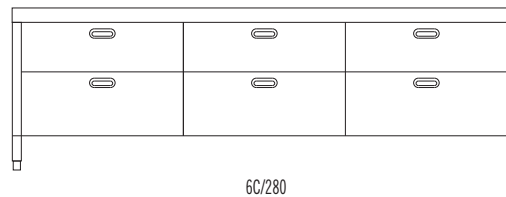

**Elementi aperti con cassetti e ripiani scorrevoli 90 cm**  
 Open elements with drawers and sliding shelves 90 cm wide

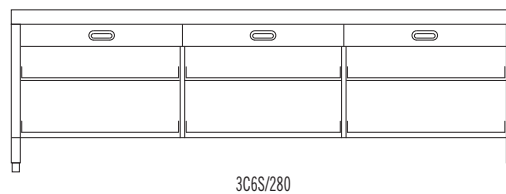
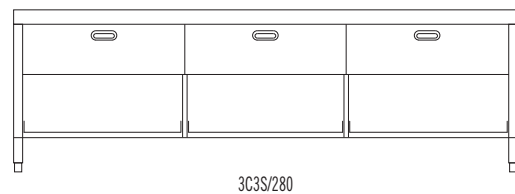

**Elemento aperto con ripiani scorrevoli 90 cm**  
 Open element with sliding shelves 90 cm wide

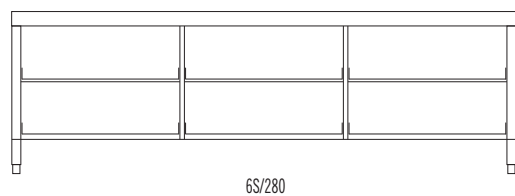

Colonne lavaggio - cottura e refrigerazione  
 Washing - cooking and refrigeration columns

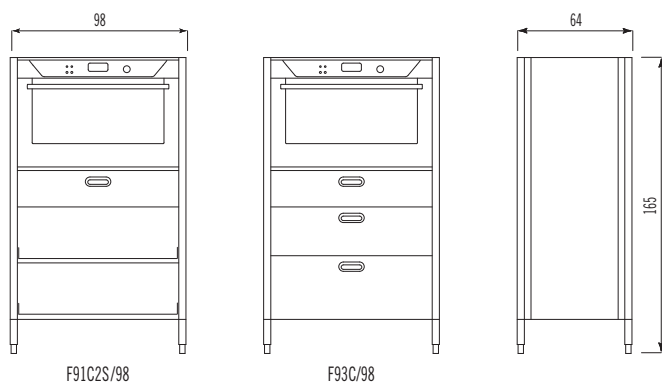
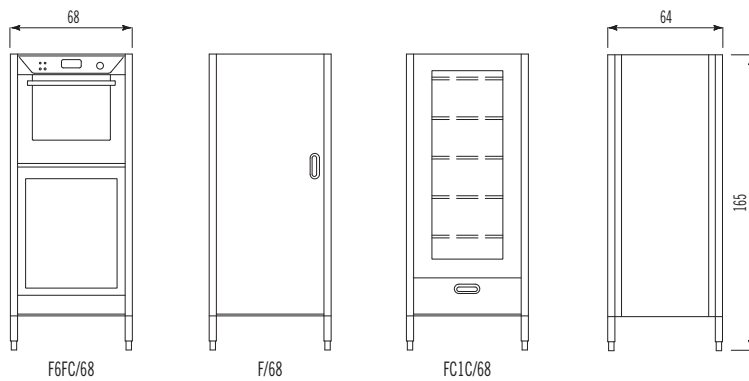
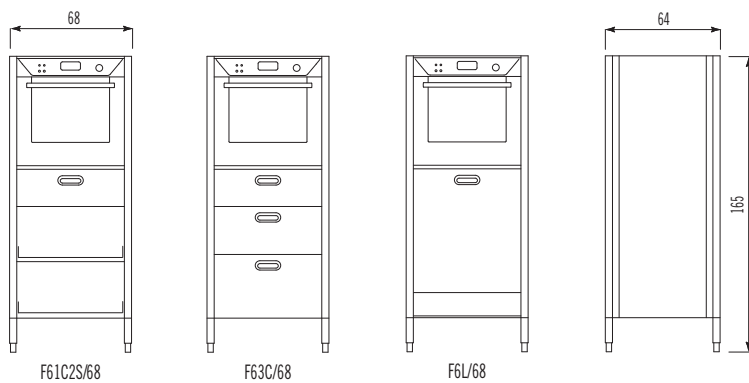

Gli elettrodomestici non sono inclusi nel prezzo dell'elemento di libera installazione. Fare riferimento al listino "Strumenti d'Oggi".  
 The household appliances are not included in the price of the freestanding unit. For appliances please consult the "Strumenti d'Oggi" price-list.

# COLONNE

## COLUMNS

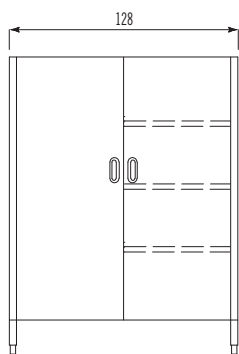

F4R/128

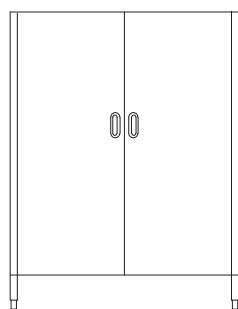

2F/128

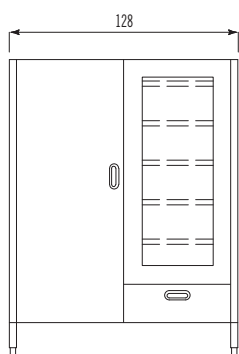
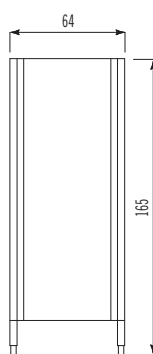

FFC1C/128

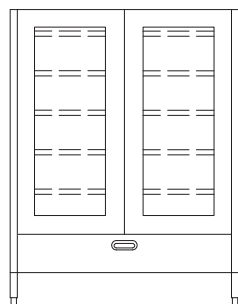

2FC1C/128

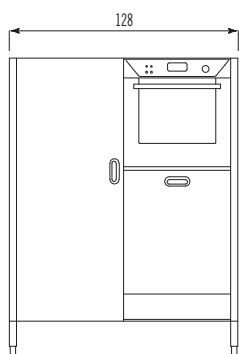
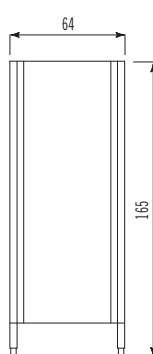

FFG1/128

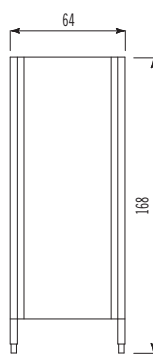

Colonne contenimento - h. 165 cm  
Storage columns - 165 cm high

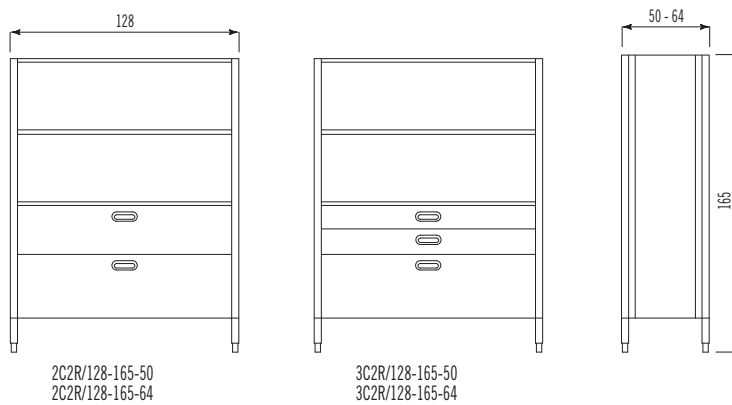
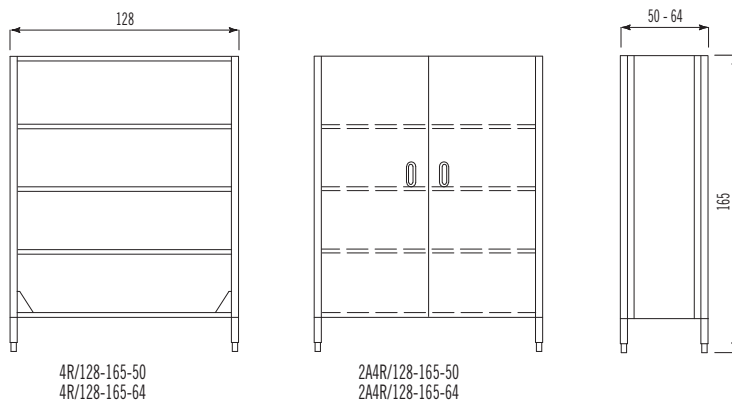
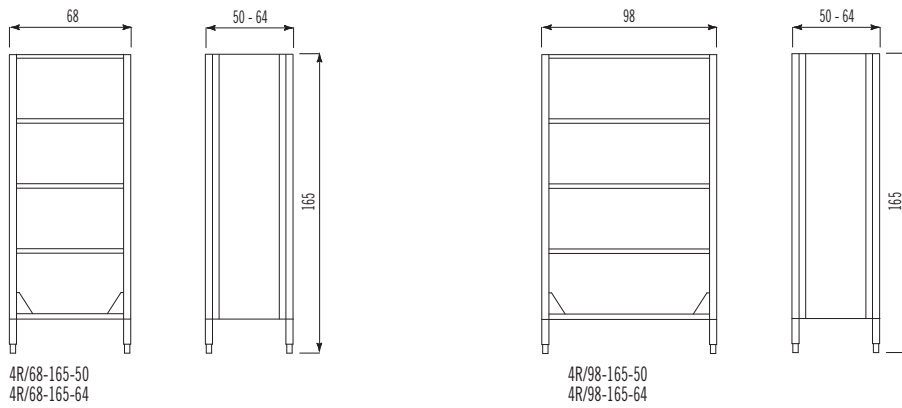

Fianchi e posteriore non sono previsti negli elementi con soli ripiani. I ripiani sono regolabili in altezza.  
Elements with shelves only do not feature any side or back walls. The shelves in the storage elements are height adjustable.



# COLONNE

## COLUMNS

Colonne contenimento - h. 185 cm  
Storage columns - 185 cm high

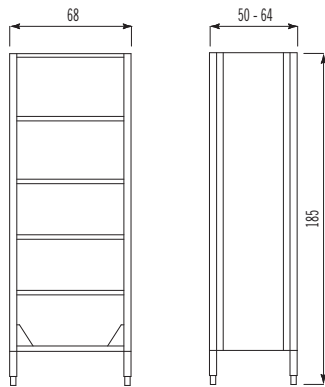

5R/68-185-50  
5R/68-185-64

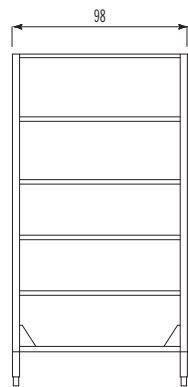
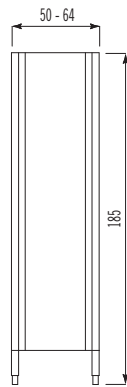

5R/98-185-50  
5R/98-185-64

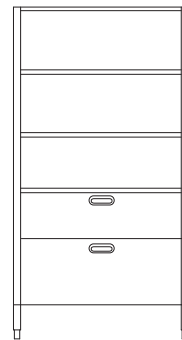

2C3R/98-185-50  
2C3R/98-185-64

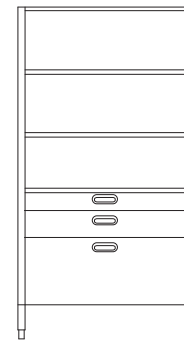

3C3R/98-185-50  
3C3R/98-185-64

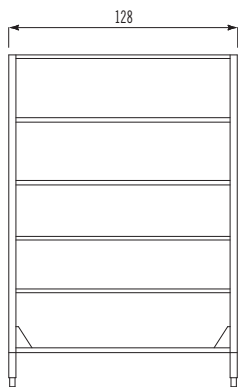
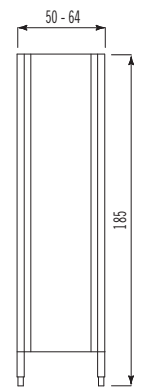

5R/128-185-50  
5R/128-185-64

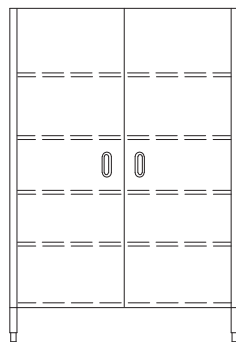

2A5R/128-185-50  
2A5R/128-185-64

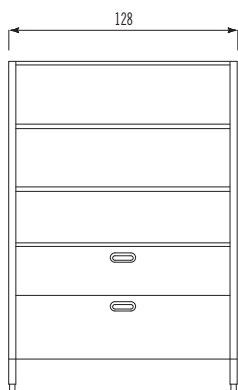
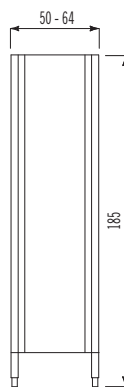

2C3R/128-185-50  
2C3R/128-185-64

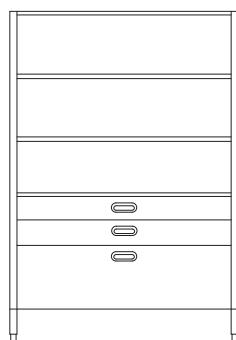

3C3R/128-185-50  
3C3R/128-185-64

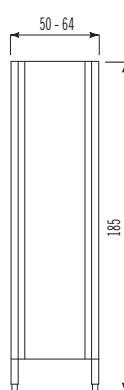

Fianchi e posteriore non sono previsti negli elementi con soli ripiani. I ripiani sono regolabili in altezza.  
Elements with shelves only do not feature any side or back walls. The shelves in the storage elements are height adjustable.

Schienali in acciaio inox a muro H. 4  
Stainless steel wall mounted backboards H. 4

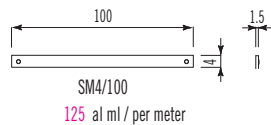

Schienali in acciaio inox a muro H. 30  
Stainless steel wall mounted backboards H. 30

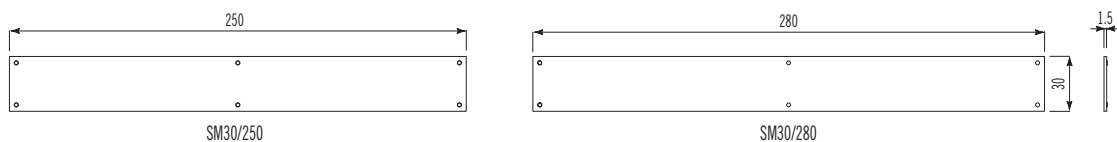
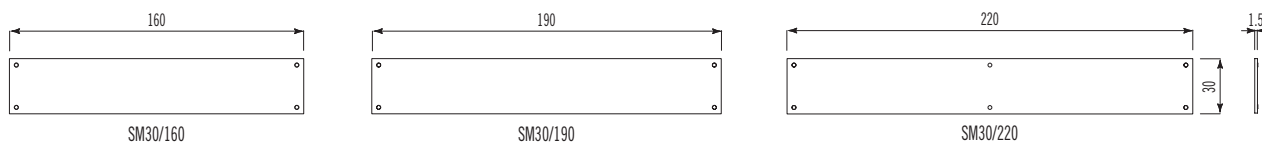
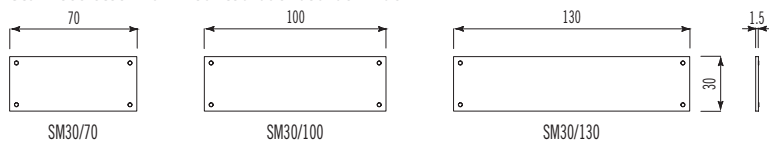

Schienali in acciaio inox a muro H. 70  
Stainless steel wall mounted backboards H. 70

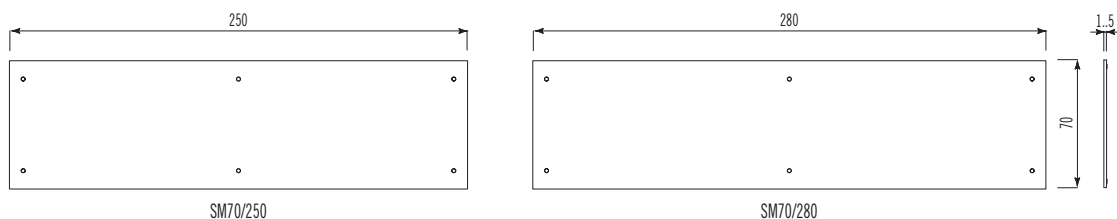
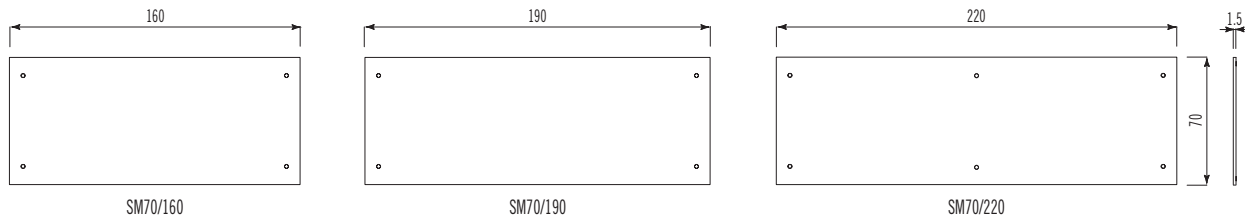
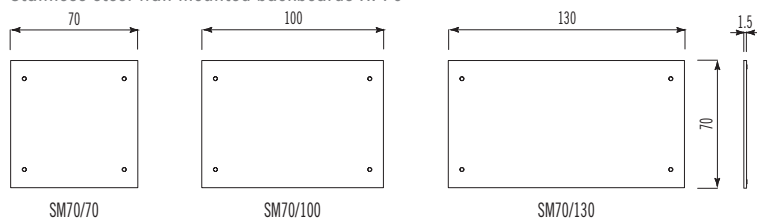

# ACCESSORI

## ACCESSORIES

### Carrelli Kitchen carts

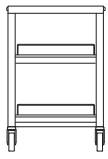

CA 80



CA 80/1C

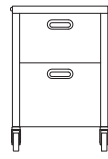

CA 80/2C



CA 80/3C

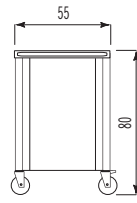

Specificare se con top inox o ceppo in legno.  
Please specify if with steel countertop or wooden chopping block.

Maggiorazione ceppo in legno.  
Surcharge for wooden chopping block.

### Portamestoli Kitchen ladle holder

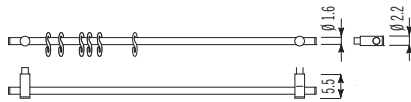

PMT  
al metro / per meter

### Maniglie laterali per elementi profondità 65 e 125 cm Side handles for elements with depth 65 and 125 cm

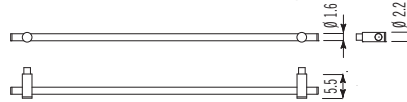

MN65  
MN125

### Torretta a scomparsa in acciaio inox con tre prese elettriche per top

Retractable three socket connector  
in stainless steel for countertop

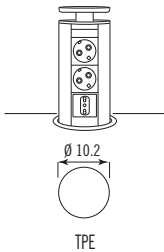

TPE

### Ruote Wheels



Le ruote possono essere applicate a tutti gli elementi freestanding.  
La versione con ruote non varia il prezzo dell'elemento.  
All the freestanding elements can be supplied with the wheels.  
The price of the element doesn't change in the wheeled version.

# OUTDOOR

## OUTDOOR

Elementi su ruote con piastra di cottura  
Elements on wheels with cooking plancha

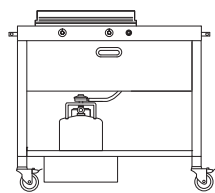
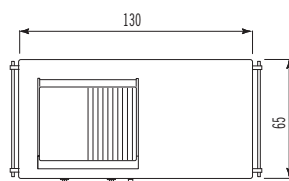
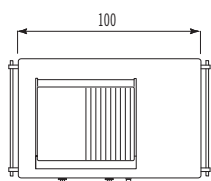

FT/100

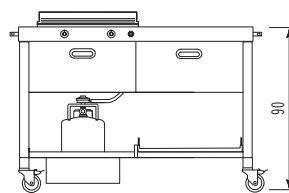

FT/130

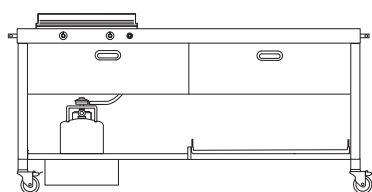
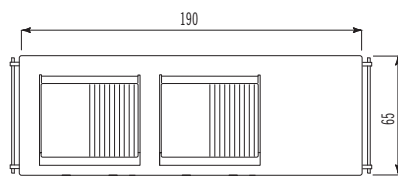
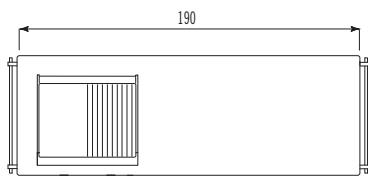

FT/190-1

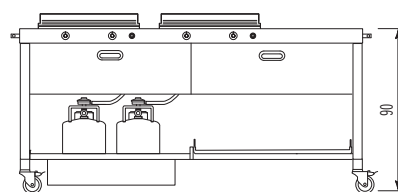

FT/190-2

Fori su top inox  
Cutout holes on the  
s/steel countertop

un foro incasso per  
lavaggio o cottura  
one built-in hole for a  
washing or cooking items

un foro incasso filo piano per  
piani cottura a induzione  
one built-in hole for  
flush-mount induction hobs

un foro e saldatura per  
lavaggio  
one hole and welding for  
washing items

un foro per piani cottura  
ribaltabili  
one hole for flip-up  
hobs

Coperture di protezione in poliestere  
Polyester protective covers

larghezza 100 cm    CP 100  
100-cm lenght

larghezza 130 cm    CP 130  
130-cm lenght

larghezza 190 cm    CP 190  
190-cm lenght



Per configurazioni con elettrodomestici aggiuntivi, fare riferimento al listino "Strumenti d'Oggi".  
For configurations with further appliances, please consult the "Strumenti d'Oggi" price-list.

# acciaio inox stainless steel



L'acciaio è la materia prima delle nostre cucine, da plasmare per esaltarne la funzionalità e da ammirare per il piacere degli occhi. Steel is the raw material we use in our kitchens, shaped to highlight its functionality and admirable for its sheer beauty.

**prezioso** I prodotti Alpes sono trattati con satinatura "argento" per esaltare le loro forme con la tonalità lucente tipica del metallo prezioso.

**elegante** La bellezza dell'acciaio inox ben si abbina ad ogni tipo di materiale ed a ogni stile progettuale.

**pratico** Ben lungi dai luoghi comuni, l'acciaio è facile e pratico da pulire. Le superfici inox non si deteriorano dopo frequenti lavaggi, perché non presentano rivestimenti superficiali di protezione, come invece molti altri materiali.

**duraturo** La resistenza all'azione di detersivi, solventi e disinfettanti consente un'azione energica e accurata durante la pulizia. L'acciaio è un materiale anticorrosivo e resistente agli shock termici e mantiene inalterati il suo aspetto e le sue caratteristiche per decenni.

**igienico** La compattezza superficiale e priva di porosità dell'acciaio indica che non rilascia e non assorbe sostanze di alcuna natura. Non si scheggia, non si usura, non si incrina e non si deteriora, impedendo la formazione di discontinuità superficiali che si trasformerebbero in ricettacoli per germi e sporcizia.

**precious** Alpes products are treated with a "silver" satin finish to highlight their forms with the typical luster of precious metal.

**elegant** The beauty of stainless steel is a fine match for any type of material and any design style.

**practical** Contrary to commonly-held notions, steel is practical and easy to clean. Stainless steel surfaces do not deteriorate after frequent washings, because they do not have protective surface treatments, like many other materials do.

**lasting** Their resistance to detergents, solvents and cleaners allows a precise and energetic cleaning action. Steel is a non-corroding material that resists thermal shock and whose appearance and characteristics remain unaltered for decades.

**hygienic** The compact and non-porous surface of steel proves that it neither releases nor absorbs substances of any kind. It does not chip, it does not wear down, it does not crack and does not decay, preventing the formation of irregularities in the surface that could create pockets of bacteria and dirt.

# pulizia dei materiali

## cleaning the materials

### **\_acciaio inox**

**cosa non fare** Non pulire i piani d'acciaio con pagliette, spazzole metalliche, detersivi abrasivi o in polvere che possano intaccare la superficie liscia, rigandola irrimediabilmente. Assolutamente da abolire i detersivi a base d'acido clorico, fluoridrico, fosforico e muriatico. Anche il semplice contatto dei loro vapori acidi può avere un'azione ossidante e corrosiva sull'acciaio inox! Lo stesso vale per acidi a base d'ipoclorito di sodio, candeggina o ammoniaca, contenuti generalmente nei detersivi per l'igiene della casa.

**cosa fare** Il sistema più efficace è sempre il più semplice. Tutte le superfici d'acciaio inox vanno trattate con acqua e sapone, o detersivo neutro, risciacquate abbondantemente e asciugate con un panno morbido. I depositi di **calcare** e d'acqua stagnante si eliminano con creme detersivi specifiche per l'acciaio, oppure con una soluzione casalinga di acqua calda mista ad aceto bianco, risciacquata a sua volta da acqua pulita. Si asciuga con cura e del calcare si è persa ogni traccia. Il rimedio migliore per rimuovere **olio e grasso** è utilizzare un prodotto liquido per piatti diluito con acqua molto calda. Sciacquare e asciugare con un panno morbido. Sulle macchie più ostinate ripassare con un panno imbevuto d'alcool.

### **\_corian®**

Atossico e non poroso, il Corian® offre caratteristiche che lo rendono ideale per i piani di lavoro. Facile da pulire e mantenere in buone condizioni, Corian® evita la proliferazione di muffe e batteri.

**per la pulizia quotidiana** utilizzare un panno umido con una crema abrasiva leggera o un comune detersivo. Agire sempre con un movimento circolare. Anche se i liquidi non possono penetrare all'interno del Corian®, è meglio eliminarli subito.

**Macchie** prodotte da caduta di liquidi come aceto, caffè, tè, succo di limone, coloranti, ketchup, vino rosso o oli vegetali: prima passare un panno umido con una crema abrasiva leggera e poi usare progressivamente una spugna abrasiva e un detersivo o una soluzione per la pulizia delle superfici a base di ammoniaca. Solo in presenza di macchie particolarmente tenaci o di un graffio significativo sarà possibile utilizzare una spugna abrasiva con della candeggina. Risciacquare parecchie volte con acqua calda ed asciugare con un panno morbido. Per ridare l'aspetto originale passare un panno umido e una crema abrasiva leggera sull'intera superficie del piano con un movimento circolare.

**Calore** non posare mai tegami caldi o roventi direttamente sul piano di lavoro di Corian®.

**Graffi** come qualsiasi materiale, presenterà leggeri segni di abrasione a seguito del normale uso quotidiano. Evitare di tagliare o tritare direttamente su Corian®.

**Le macchie accidentali di sostanze chimiche** come sverniciatori, prodotti per la pulizia dei metalli o dei forni, prodotti contenenti cloruro di metilene, acidi, prodotti a base di acetone, ecc., devono essere prontamente eliminate con una abbondante quantità di acqua e sapone.

### **\_ceppi in legno**

Il ceppo di legno va pulito esclusivamente con un panno umido.

Il trattamento ideale idrorepellente sarebbe spalmare periodicamente il legno con olio ad uso alimentare, al fine di limitarne l'assorbimento d'acqua senza alterare le proprietà organolettiche dei cibi che ne vengono a contatto. Il sole o le fonti di calore a diretto contatto con il legno possono alterarne il colore.

### **\_stainless steel**

**what not to do** Do not clean steel surfaces with steel pads, metal brushes, abrasive or powder detergents that could damage the polished surface, scratching it irreparably. Absolutely prohibited are detergents based on chloric, hydrofluoric, phosphoric and muriatic acids. The mere contact of their acid vapors can have an oxidizing and corrosive action on stainless steel! The same is true for acids based on sodium hypochlorite, bleach or ammonia, generally present in detergents for the home.

**what to do** The most effective system is always the simplest. All steel surfaces should be washed with soap and water, or neutral detergents, rinsed with abundant water and dried with a soft cloth. **Lime** deposits and stagnant water may be removed with specific cream detergents for steel, or with a home-made solution of warm water and white vinegar: clean then rinse with clean water. Dry carefully and there will no more trace of lime. The best remedy to clean **oil and grease** is to use liquid dish soap diluted with very hot water. Rinse and dry with a soft cloth. The most stubborn stains may be removed with a soft cloth imbued in alcohol.

### **\_corian®**

Corian® is non-toxic and non-porous, just two of the characteristics that make it ideal for worktops. Easy to clean and keep in good condition, Corian® prevents the proliferation of mould and bacteria.

**For everyday cleaning**, just use a damp cloth and a mild cream abrasive cleanser or a common household degreaser. Always clean using a circular motion. Although liquids cannot penetrate Corian®, it is best to wipe up spills as they occur.

**Common household spills**, such as vinegar, coffee, tea, lemon juice, dyes, ketchup, red wine or vegetable spills: First, try to clean with a damp cloth and a mild cream abrasive, then progress with an abrasive plastic scouring pad and a detergent or an ammonia based hard-surface cleaner. Only with a really persistent stain as lily pollen, or saffron, or with a light scratch, should you need to resort to an abrasive plastic scouring pad and rub over the stain with some bleach. Rinse several times with warm water and dry with a soft cloth. Always restore the overall luster afterwards, using a damp cloth and a mild cream abrasive cleaner and blend the scrubbed area into the entire surface by rubbing in a circular motion.

**Heat** Never put hot pans directly on a Corian® top.

**Scratches** Like all materials it will develop slight abrasion marks in normal daily use. Never cut or chop on Corian®.

**Accidental spills of strong chemicals** (e.g. paint stripper, brush cleaners, metal cleaners, oven cleaners, cleaners containing methylene chloride, acid drain cleaners, acetone-based nail varnish removers etc.) should be flushed promptly with plenty of soapy water to avoid damaging worktops.

### **\_wood chopping board**

The wood chopping board should be cleaned exclusively with a damp cloth.

The ideal waterproofing treatment would be to periodically treat the wood with food oil, so that it limits the absorption of water without altering the organic properties of the food that comes into contact with it.

The sun and other heat sources in direct contact with the wood can alter its colour.



