

09

SPIE LUMINOSE

WARNING LIGHTS

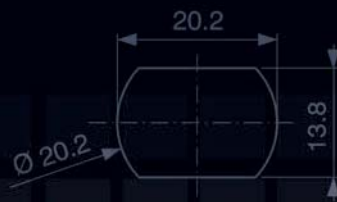

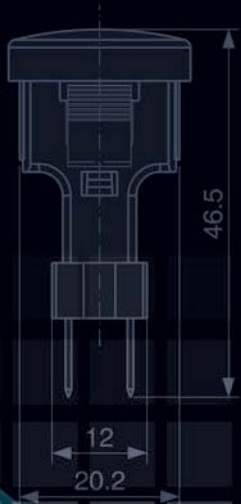
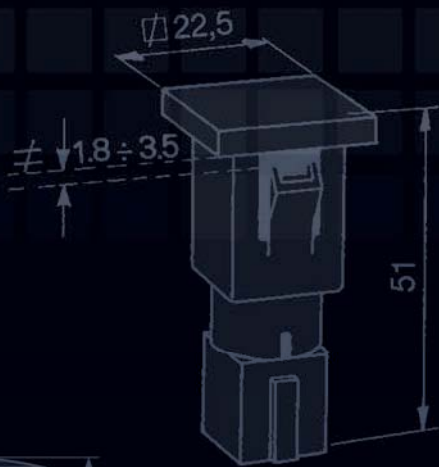



09

SPIE LUMINOSE

WARNING LIGHTS



• **Segnalatori luminosi ø 16**

Grado di protezione: IP66
Tensione di alimentazione: 12 o 24 V ÷ 60mA
Materiale: Policarbonato

• **Warning lights ø 16**

Sealing: IP66
Power supply voltage: 12 or 24 V ÷ 60mA
Material: Polycarbonate

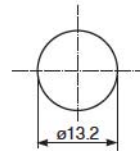
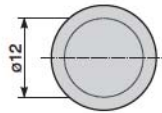
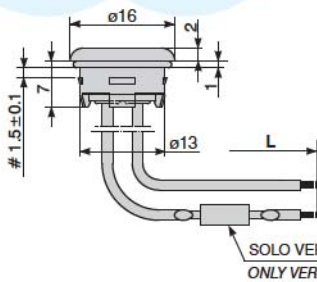

09.180.005



TAPPO NERO
BLACK CUP

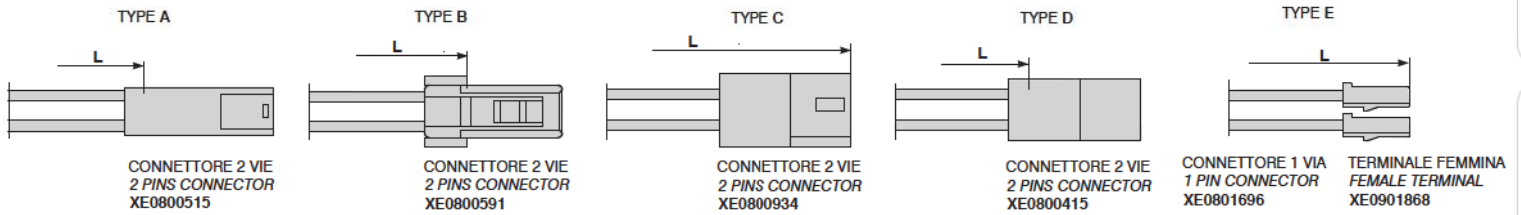

09.180.020 12V
09.180.024 24V



L = 100
neutro
neutral

09.180.021 12V
09.180.025 24V



L = 100
neutro
neutral

09.180.022 12V
09.180.026 24V



L = 100
neutro
neutral

09.180.023 12V
09.180.027 24V



L = 100
neutro
neutral

09.180.028 12V



L = 100
marcia lenta
slow gear

09.180.029 12V



L = 100
marcia veloce
fast gear

09.180.030 12V



L = 100
emergenza
hazard

09.180.031 12V
09.180.037 24V



L = 100
abbaglianti
high beams

09.180.032 24V



L = 100
con capocorda
with terminal
neutro
neutral

09.180.033 24V



L = 100
con capocorda
with terminal
neutro
neutral

09.180.034 12V



L = 150
TYPE D
presa di forza
power take-off

09.180.035 12V
09.180.113 24V



L = 100
anabbaglianti
low beams

09.180.042 24V



L = 100

09.180.043 12V



L = 100
low
low

09.180.044 12V



L = 100
high
high

09.180.045 12V



L = 100
neutro
neutral
09.180.021+
30.17.06308

09.180.046 12V



L = 100
neutro
neutral
09.180.021+
30.17.06308

09.180.047 12V
09.180.038 24V



L = 100
indicatore
direzionale
turn signal

09.180.048 12V
09.180.049 24V





















































L = 100
neutro
neutral

09.180.050 12V



L = 100
illuminazione
generale
master switch

<p>09.180.136 12V</p>  <p>L = 100 selezione faro da lavoro su telescopio <i>worklamp selection on telescopic</i></p>	<p>09.180.137 12V 09.180.036 24V</p>  <p>L = 100 luci di posizione <i>position lights</i></p>	<p>09.180.138 12V</p>  <p>L = 120 TYPE C emergenza hazard</p>	<p>09.180.139 12V</p>  <p>L = 120 TYPE C abbaglianti high beams</p>	<p>09.180.140 12V</p>  <p>L = 120 TYPE C indicatore indicator</p>
<p>09.180.142 12V 09.180.118 24V</p>  <p>L = 140 TYPE A indicatore LH <i>LH indicator</i></p>	<p>09.180.143 12V 09.180.119 24V</p>  <p>L = 140 TYPE A indicatore RH <i>RH indicator</i></p>	<p>09.180.144 12V</p>  <p>L = 140 TYPE A illuminazione generale <i>master switch</i></p>	<p>09.180.145 12V 09.180.120 24V</p>  <p>L = 140 TYPE A abbaglianti high beams</p>	<p>09.180.146 12V</p>  <p>CHECK</p> <p>L = 100</p>
<p>09.180.147 12V</p>  <p>L = 100 bloccaggio assale <i>cross-shaft axle lock</i></p>	<p>09.180.148 12V</p>  <p>L = 100 blocco idraulico <i>hydraulic lock</i></p>	<p>09.180.149 12V</p>  <p>L = 100 stabilizzatore DX <i>RH stabilizer</i></p>	<p>09.180.150 12V</p>  <p>L = 100 stabilizzatore DX <i>RH stabilizer</i></p>	<p>09.180.151 12V</p>  <p>ABS</p> <p>L = 100</p>
<p>09.180.152 12V 09.180.121 24V</p>  <p>L = 140 TYPE A anabbaglianti low beams</p>	<p>09.180.153 12V</p>  <p>L = 140 TYPE A neutro neutral</p>	<p>09.180.154 12V</p>  <p>L = 140 emergenza hazard</p>	<p>09.180.155 12V</p>  <p>L = 100 bloccaggio differenziale <i>differential lock</i></p>	<p>09.180.156 12V</p>  <p>L = 50 TYPE B avaria pressione olio <i>oil pressure failure</i></p>
<p>09.180.157 12V</p>  <p>L = 100 filtro olio serbatoio idrostatico <i>hydrostatic tank oil filter</i></p>	<p>09.180.158 12V</p>  <p>L = 100 TYPE A +O-ring batteria tampono <i>buffer battery</i></p>	<p>09.180.159 12V</p>  <p>L = 100 TYPE A +O-ring neutro neutral</p>	<p>09.180.161 24V</p>  <p>L = 100 TYPE A neutro neutral</p>	<p>09.180.176 12V 09.180.162 24V</p>  <p>L = 100 bloccaggio assale <i>cross-shaft axle lock</i></p>
<p>09.180.163 12V</p>  <p>L = 100 filtro benzina <i>fuel filter</i></p>	<p>09.180.165 12V</p>  <p>L = 100 TYPE A + O-ring icona personalizzata <i>custom icon</i></p>	<p>09.180.166 12V</p>  <p>L = 100 ABS rimorchio <i>trailer ABS</i></p>	<p>09.180.167 12V</p>  <p>L = 155 TYPE E neutro neutral</p>	<p>09.180.168 12V</p>  <p>L = 100 TYPE A anabbaglianti low beams</p>
<p>09.180.169 12V</p>  <p>L = 100 TYPE A freno a mano inserito <i>hand brake on</i></p>	<p>09.180.170 12V</p>  <p>L = 100 TYPE A avaria freni <i>brakes failure</i></p>	<p>09.180.171 12V</p>  <p>L = 140 TYPE A indicatore LH <i>indicator LH</i></p>	<p>09.180.172 12V</p>  <p>L = 140 TYPE A indicatore RH <i>indicator RH</i></p>	<p>09.180.173 12V</p>  <p>L = 100 TYPE A illuminazione generale <i>master switch</i></p>
<p>09.180.174 12V</p>  <p>L = 50 TYPE B presa di forza PTO overspeed</p>	<p>09.180.175 12V</p>  <p>L = 100 TYPE A + O-ring riscaldamento specchietto <i>mirror heating</i></p>	<p>09.180.177 12V</p>  <p>L = 120 TYPE C indicatori di direzione <i>turn signal</i></p>	<p>09.180.178 12V</p>  <p>L = 100 TYPE A temperatura motore per emissione <i>engine emission system temperature</i></p>	<p>09.180.179 12V</p>  <p>L = 100 TYPE A esclusione filtro antiparticolato <i>particulate filter inhibition</i></p>
<p>09.180.180 12V</p>  <p>L = 100 TYPE A attivazione filtro antiparticolato <i>particulate filter regeneration</i></p>	<p>09.180.181 12V</p>  <p>L = 100 TYPE A avaria motore <i>engine failure</i></p>	<p>09.180.182 12V</p>  <p>L = 100 TYPE A arresto motore <i>engine stop</i></p>	<p>09.180.183 12V</p>  <p>L = 100 TYPE A assale axle</p>	<p>09.180.184 12V</p>  <p>L = 100 TYPE A pre riscaldamento <i>preheating</i></p>
<p>09.180.185 12V</p>  <p>L = 100 TYPE A icona personalizzata <i>custom icon</i></p>	<p>09.180.186 12V</p>  <p>L = 100 TYPE A icona personalizzata <i>custom icon</i></p>	<p>09.180.187 12V</p>  <p>L = 100 TYPE A icona personalizzata <i>custom icon</i></p>	<p>09.180.188 12V</p>  <p>L = 100 TYPE A icona personalizzata <i>custom icon</i></p>	<p>09.180.189 12V</p>  <p>L = 100 TYPE A freno a mano inserito <i>hand brake on</i></p>
<p>09.180.190 12V</p>  <p>L = 100 TYPE A neutro neutral</p>				

• **Segnalatori luminosi ø 16**

Grado di protezione: IP66
Tensione di alimentazione: 12 o 24V
Materiale: Policarbonato



• **Warning lights ø 16**

Sealing: IP66
Power supply voltage: 12 or 24V
Material: Polycarbonate

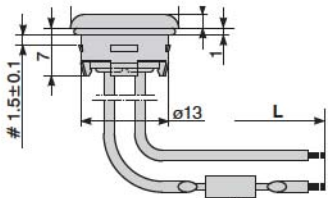

SOLO VERSIONI 24 V (RESISTENZA)
ONLY VERSION 24 V (RESISTANCE)

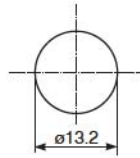
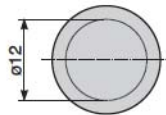

09.180.005



TAPPO NERO
BLACK CUP

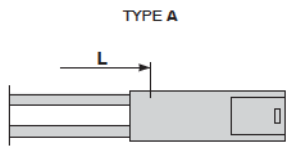

TYPE A

CONNETTORE 2 VIE
2 PINS CONNECTOR
XE0800515

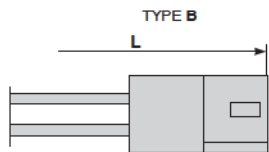

TYPE B

CONNETTORE 2 VIE
2 PINS CONNECTOR
XE0800934

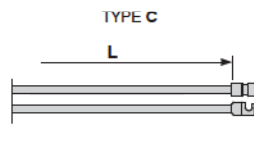

TYPE C

TERMINALE FEMMINA
FEMALE TERMINAL
XE0901353

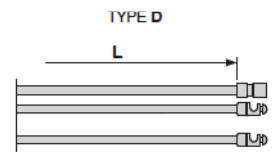

TYPE D

TERMINALE FEMMINA
FEMALE TERMINAL
XE0901353

TERMINALE MASCHIO

TERMINALE MASCHIO

09.180.500 12V
09.180.501 24V



neutro
neutral

09.180.502 12V
09.180.503 24V



neutro
neutral

09.180.504 12V
09.180.505 24V



neutro
neutral

09.180.506 12V
09.180.507 24V



neutro
neutral

09.180.508 12V
09.180.509 24V



neutro
neutral

09.180.510 12V
09.180.511 24V



rimorchio inserito
trailer on

09.180.512 12V
09.180.513 24V



rimorchio inserito
trailer on

09.180.514 12V
09.180.515 24V



L = 100
luci di posizione
position lights

09.180.516 12V
09.180.517 24V



L = 100
indicatore di
direzione
turn signal

09.180.518 12V
09.180.519 24V



L = 100
icona
personalizzata
custom icon

09.180.520 12V



L = 100
TYPE A
abbaglianti
high beams

09.180.521 24V



L = 100
abbaglianti
high beams

09.180.522 12V
09.180.523 24V



L = 100
preriscaldamento motore
engine preheating

09.180.524 12V
09.180.525 24V



L = 100
carica generatore
generator load

09.180.526 12V
09.180.527 24V



L = 100
freno a mano
inserito
hand brake on

09.180.528 12V
09.180.529 24V



L = 100
filtro olio serbatoio
idrostatico
hydrostatic tank
oil filter

09.180.530 12V
09.180.531 24V



L = 100
livello olio
trasmissione
transmission oil
level

09.180.532 12V
09.180.533 24V



L = 100
filtro aria intasato
clogged air cleaner

09.180.534 12V
09.180.535 24V



L = 100
pressione olio
motore
engine oil pressure

09.180.536 12V
09.180.537 24V



L = 100
bloccaggio assale
cross-shaft axle
lock

09.180.538 12V
09.180.539 24V



L = 100
abbaglianti
high beams

09.180.540 12V
09.180.541 24V



L = 100
anabbaglianti
low beams

09.180.542 12V
09.180.543 24V



L = 100
illuminazione
generale
master switch

09.180.544 12V
09.180.545 24V



L = 100
freno a mano
inserito
hand brake on

09.180.546 12V
09.180.547 24V



L = 100
cinture di sicurezza
safety belt

09.180.548 12V
09.180.549 24V



L = 100
avaria freni
brakes failure

09.180.550 12V
09.180.551 24V



L = 100
indicatore LH
indicator LH

09.180.552 12V
09.180.553 24V



L = 100
indicatore RH
indicator RH

09.180.554 12V
09.180.555 24V



L = 100
bloccaggio assale
cross-shaft axle lock

09.180.556 12V



L = 100
TYPE B
indicatore direzione
turn signal

09.180.557 24V



L = 100
TYPE C
retronebbia
rear fog light

09.180.558 24V



L = 100
TYPE C
riserva carburante
fuel reserve

09.180.560 24V



L = 100
TYPE C
alta temperatura
olio cambio
high transmission
oil temperature

09.180.561 24V



L = 100
TYPE C
filtro acqua
water filter

09.180.562 24V



L = 100
TYPE C
riscaldamento
motore
engine warm up

09.180.564 24V



L = 100
TYPE C
lampada
di sicurezza antiskid
motrice
tractor abs safety
lamp

09.180.565 24V



L = 100
TYPE C
abbaglianti
high beam

09.180.567 24V



L = 100
TYPE C
carica generatore
generator load

09.180.580 12V
09.180.568 24V



L = 100
TYPE C
freno a mano
inserito
hand brake on

09.180.569 24V



L = 100
TYPE C
bassa pressione
olio motore
low engine oil
pressure

09.180.570 24V



L = 100
TYPE C
massima
temperatura acqua
max water
temperature

09.180.571 24V



L = 100
TYPE C
avaria convertitore
di tensione
voltage converter
failure

09.180.572 24V



L = 100
TYPE C
bloccaggio
differenziale
longitudinale
longitudinal
differential lock

09.180.573 24V



L = 100
TYPE C
bloccaggio
differenziale
differential lock

09.180.574 24V



L = 100
TYPE C
bloccaggio
differenziale ponte
anteriore
front bridge
differential lock

09.180.576 24V



L = 100
TYPE C
riscaldamento
supplementare
additional heating

09.180.577 24V



L = 100
TYPE C
avaria freni
brakes failure

09.180.578 12V
09.180.579 24V



L = 100
TYPE C
illuminazione
generale
master switch

09.180.581 12V



L = 100
TYPE D

09.180.582 12V



L = 100
TYPE A

- **Segnalatori luminosi ø 18**

Grado di protezione: IPX4
Tensione di alimentazione: 12V
Materiale corpo: Policarbonato



- **Warning lights ø 18**

Sealing: IPX4
Power supply voltage: 12V
Housing material: Polycarbonate

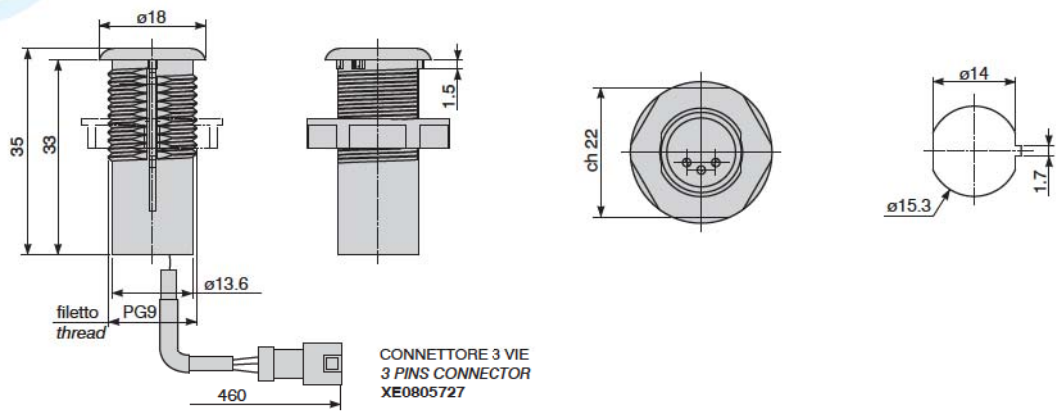

09.1300.1011



09.1300.1021



ATC

- **Segnalatori luminosi ø 23**

Grado di protezione: IP40
 Tensione di alimentazione: 12 o 24V
 Materiale lente: Metacrilato
 Materiale corpo: Policarbonato bianco

- **Warning lights ø 23**

Sealing: IP40
 Power supply voltage: 12 or 24V
 Lens material: Methacrylate
 Housing material: White polycarbonate

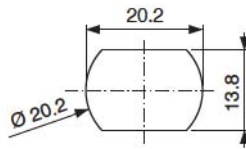
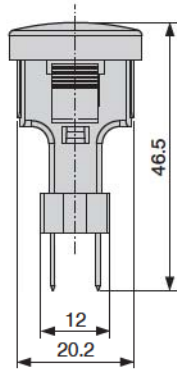

VETRINO IN METACRILATO - METHACRYLATE LENS

09.0900.0000



presa di forza
power take-off

09.0901.0000



neutro
neutral

09.0902.0000



neutro
neutral

09.0903.0000



neutro
neutral

09.0904.0000



regolazione orologio
clock
adjustment

09.0905.0000



neutro
neutral

09.0906.0000



neutro
neutral

09.0938.0000



icona
personalizzata
custom icon

09.0908.0000



indicatore
indicator

09.0909.0000



freno a mano
inserito
hand brake on

09.0910.0000



rallentatore
retarder

09.0911.0000



luci di
profondità
high beams

09.0912.0000



bloccaggio
inclinazione assale
axle inclination lock

09.0913.0000



pressione olio
motore
engine oil
pressure

09.0914.0000



marcia lenta
slow gear

09.0915.0000



preiscaldo
preheating

09.0916.0000



avaria motore
engine failure

09.0917.0000



avaria motore
engine failure

09.0918.0000



rpm costanti
constant rpm

09.0919.0000



carica
generatore
generator load

09.0920.0000



temperatura olio
circuito idrostatico
hydrostatic circuit
oil
temperature

09.0921.0000



temperatura
acqua
water
temperature

09.0922.0000



riserva
carburante
fuel reserve

09.0923.0000



luci di posizione
position lights

09.0924.0000



filtro aria intasato
clogged air cleaner

09.0925.0000



livello olio
trasmissione
transmission oil
level

09.0926.0000



trazione anteriore
inserita
front drive on

09.0927.0000



icona
personalizzata
custom icon

09.0928.0000



emergenza
hazard

09.0929.0000



emergenza
hazard

09.0930.0000



pressione olio
idraulico
hydraulic oil
pressure

09.0931.0000



icona
personalizzata
custom icon

09.0932.0000



indicatore direzione
turn signal

09.0933.0000



anabbaglianti
low beams

09.0934.0000



icona
personalizzata
custom icon

09.0935.0000



lampada rotante
rotating beacon

09.0936.0000



icona
personalizzata
custom icon

09.0937.0000



indicatore direzione
turn segnale

09.0939.0000



avaria freni
brakes failure

- **Segnalatori luminosi ø 25**

Grado di protezione: IP65
Tensione di alimentazione: 12 o 24V
Materiale lente: Metacrilato
Materiale corpo: Poliammide

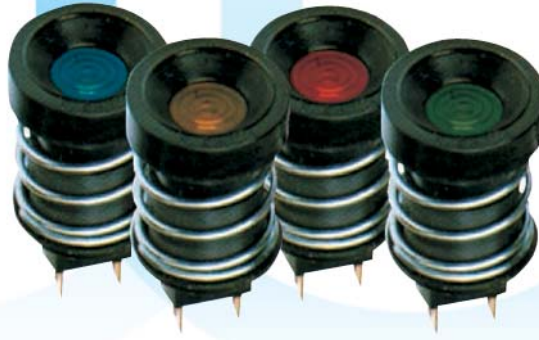

- **Warning lights ø 25**

Sealing: IP65
Power supply voltage: 12 or 24V
Lens material: Methacrylate
Housing material: Polyamide

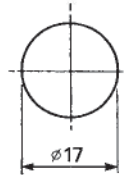
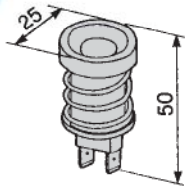

W3W
12V-3W
24V-3W

0002.0011



neutro
neutral

0002.0012



neutro
neutral

0002.0013



neutro
neutral

0002.0018



neutro
neutral

- **Segnalatori luminosi 20x23 mm.**

Grado di protezione: IP65
Tensione di alimentazione: 12 o 24V
Materiale: Polietilene



- **Warning lights 20x23 mm.**

Sealing: IP65
Power supply voltage: 12 or 24V
Material: Polyethylene

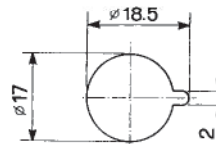
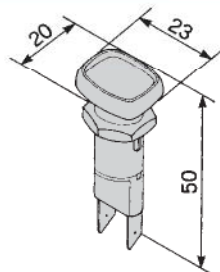

W3W
12V-3W
24V-3W

09.286.020



neutro
neutral

09.286.022



neutro
neutral

09.286.021



neutro
neutral

09.286.023



filtro aria intasato
clogged air cleaner

• **Segnalatori luminosi 22,5x22,5 mm.**

Grado di protezione: IP53
Tensione di alimentazione: 12 o 24V
Materiale lente: Metacrilato
Materiale corpo: Poliammide

• **Warning lights 22,5x22,5 mm.**

Sealing: IP53
Power supply voltage: 12 or 24V
Lens material: Methacrylate
Housing material: Polyamide

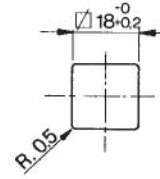
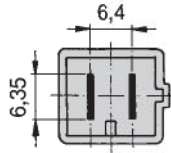
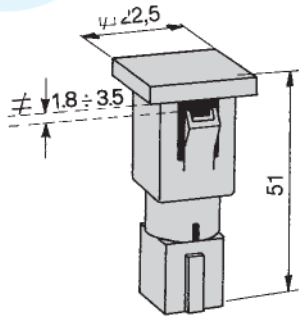

30.33.04739
TAPPO - COVER

09.450.000



neutro
neutral

09.451.000



neutro
neutral

09.452.000



neutro
neutral

09.453.000



neutro
neutral

09.454.000



neutro
neutral

09.455.000



neutro
neutral

09.456.000



illuminazione
generale
master switch

09.457.000



carica
generatore
generator load

09.458.000



luci di
profondità
high beams

09.459.000

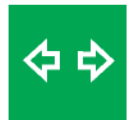

indicatori di
direzione
motrice
tractor's
turn signals

09.460.000



luci di
emergenza
hazard
lights

09.461.000



preiscaldamento
motore
engine
preheating

09.462.000



bassa pressione
aria freni
low brakes
air pressure

09.463.000



bassa pressione
olio motore
low engine
oil pressure

09.464.000



alta
temperatura
olio cambio
high transmission
oil temperature

09.465.000



riscaldamento
supplementare
additional heating

09.466.000



luci di ingombro
u.s.a.
side marker lamps
u.s.a.

09.467.000



rottura cinghia
belt breaking

09.468.000



livello combustibile
fuel level

09.469.000



bassa pressione
aria rimorchio
low trailer
air pressure

09.470.000



bloccaggio
differenziale
differential lock

09.471.000



indicatori di
direzione rimorchio
trailer's turn signal

09.472.000



freno a mano
inserito
hand brake on

09.473.000



ribaltamento
cabina
cab's overturn

09.474.000



fuori giri
over rpm

09.475.000



inefficienza freni
idraulici
hydraulic
brakes failure

09.476.000



massima
temperatura acqua
max water
temperature

09.477.000



retronebbia
rear fog light

09.478.000

















































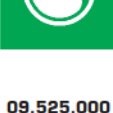
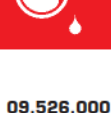
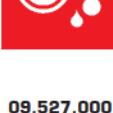
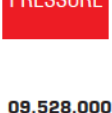
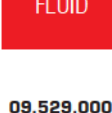

riscaldamento
retrovisore
rear-view
mirror heating

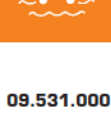
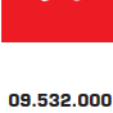
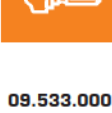
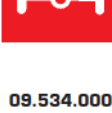
09.479.000



bassa pressione
aria ponte
low bridge air
pressure

09.480.000  bassa pressione aria ponte <i>low bridge air pressure</i>	09.481.000  avaria freni <i>brakes failure</i>	09.482.000  porta aperta <i>open door</i>	09.483.000  porta aperta 1 <i>open door 1</i>	09.484.000  porta aperta 2 <i>open door 2</i>
09.485.000  porta aperta 3 <i>open door 3</i>	09.486.000  richiesta fermata <i>stop request</i>	09.487.000  marcia veloce <i>fast gear</i>	09.488.000  marcia lenta <i>slow gear</i>	09.489.000  usura frizione <i>clutch wear</i>
09.490.000  filtro aria intasato <i>clogged air cleaner</i>	09.491.000  presa di forza inserita <i>power take-off on</i>	09.492.000  usura freni <i>brake wear</i>	09.493.000  sollevamento 3° asse <i>3rd axle lifting</i>	09.494.000  cassone ribaltato <i>dump body</i>
09.495.000  sollevamento veicolo <i>full kneeling</i>	09.496.000  ventilazione forzata <i>fan</i>	09.497.000  sganciamento rimorchio <i>trailer unhooking</i>	09.498.000  illuminazione piano di carico <i>compartment lighting</i>	09.499.000  basso livello liquido freni <i>low brake fluid level</i>
09.500.000  frigorifero inserito <i>refrigeration on</i>	09.501.000  fendinebbia <i>fog lights</i>	09.502.000  presa di forza <i>power take-off</i>	09.503.000  aspiratore <i>extractor fan</i>	09.504.000  elettroventilatore <i>electric fan</i>
09.505.000  riscaldamento interno <i>heating</i>	09.506.000  preriscaldamento motore 1° fase <i>1st period engine preheating</i>	09.507.000  preriscaldamento motore 2° fase <i>2nd period engine preheating</i>	09.508.000  condizionatore <i>air conditioning</i>	09.509.000  cintura di sicurezza <i>safety belt</i>
09.510.000  bloccaggio differenziale longitudinale <i>longitudinal differential lock</i>	09.511.000  rallentatore elettrico <i>electrical decelerator</i>	09.512.000  lampada rotante <i>rotating beacon</i>	09.513.000  bloccaggio differenziale ponte anteriore <i>front bridge differential lock</i>	09.514.000  trazione posteriore <i>rear drive</i>
09.515.000  bloccaggio differenziale ponti <i>bridges differential lock</i>	09.516.000  trazione anteriore inserita <i>front wheel-drive on</i>	09.517.000  corrente alternata a bordo <i>alternating current on board</i>	09.518.000  batteria di trazione ricaricata <i>recharged drive battery</i>	09.519.000  usura freni <i>brake wear</i>
09.520.000  convertitore inserito <i>converter on</i>	09.521.000  pressione olio convertitore <i>converter oil pressure</i>	09.522.000  temperatura olio convertitore <i>converter oil temperature</i>	09.523.000  insufficiente pressione freni <i>low brake pressure</i>	09.524.000  basso livello liquido freni <i>low brake fluid level</i>
09.525.000  freno di parcheggio <i>parking brake</i>	09.526.000  pressurizzazione gruppi meccanici <i>mechanical unit pressurization</i>	09.527.000  portellone aperto <i>open hatch cover</i>	09.528.000  presa movimento <i>power take-off</i>	09.529.000  bloccaggio differenziale ponte anteriore <i>front bridge differential lock</i>
09.530.000  avaria impianto sospensioni pneumatiche <i>suspension system failure</i>	09.531.000  emettitrice <i>ticket machine</i>	09.532.000  radiotelefono <i>radio telephone</i>	09.533.000  obliteratrice <i>stamping machine</i>	09.534.000  illuminazione cartelli <i>signs lighting</i>

09.535.000  pre-usura freni brakes pre-wear	09.536.000  vetro laterale destrto termico right; wing mirror heating	09.537.000  elettrosiscaldamento sbrinatoro parabrezza electrical windscreen heating	09.538.000  riflettore avarie failure repeater	09.539.000  basso livello acqua motore low engine water level
09.540.000  portellone aperto open hatch cover	09.541.000  bassa pressione molle ad aria low air springs pressure	09.542.000  freno di stazionamento parking brake	09.543.000  lampada di sicurezza antiskid motrice tractor abs safety lamp	09.544.000  lampada di sicurezza antiskid rimorchio trailer abs safety lamp
09.545.000  lampada informazione antiskid abs information lamp	09.546.000  illuminazione vano attrezzi tools box lighting	09.547.000  lampada rotante rotating beacon	09.548.000  presa di forza inserita power take-off on	09.549.000  limitatore velocità speed limiting device
09.850.000  luci esterne external lamps	09.851.000  freno idraulico hydraulic brake	09.852.000  trazione integrale 4 WD	09.853.000  richiesta fermata stop request	09.854.000  freno di fermata stop brake
09.855.000  stacco teleruttore generale di corrente master switch cut-off	09.856.000  ventilazione autista driver fan	09.857.000  bloccaggio differenziale longitudinale longitudinal differential lock	09.858.000  alta temperatura olio motore high engine oil temperature	09.859.000  pompa di sentina bilge pump
09.860.000  alta temperatura motore engine high temperature	09.861.000  presa di forza inserita power take-off on	09.862.000  bloccaggio differenziale differential lock	09.863.000  avaria freni ponte anteriore front bridge brake failure	09.864.000  avaria freni ponte posteriore rear bridge brake failure
09.865.000  sollevamento 3° asse 3rd axle lifting	09.866.000  pressurizzazione gruppi meccanici mechanical unit pressurization	09.867.000  presa movimento power take-off	09.868.000  bloccaggio differenziale ponte anteriore front bridge differential lock	09.869.000  starter
09.870.000  ventola riscaldamento heating fan	09.871.000  HYDR livello olio idraulico hydraulic oil level	09.872.000  pompa innestata pump engaged	09.873.000  serranda aperta open gate	09.874.000  verricello innestato winch engaged
09.875.000  retronebbia rear fog light	09.876.000  colonna fari alzata raised lamps column	09.877.000  presa movimento power take-off	09.878.000  lunotto termico heated rear window	09.879.000  filtro olio trasmissione transmission oil filter
09.913.000  sollevamento simultaneo assi seminorchio semitrailer axles lifting	09.914.000  convertitore inserito converter on	09.915.000  max temperatura olio convertitore max converter oil temperature	09.916.000  idroguida hydroguide	09.917.000  ant. sollevamento assi anteriori seminorchio semitrailer front axles lifting
09.918.000  post. sollevamento assi posteriori seminorchio semitrailer rear axles lifting	09.919.000  inserimento gonfiaggio centralizzato pneumatici tyres inflation	09.920.000  bloccaggio assale axle lock	09.921.000  Km limitatore velocità speed limiting device	09.922.000  bloccaggio assale axle lock

09.927.000



filtro olio idrostatico
hydrostatic oil filter

09.928.000



presenza acqua nel filtro gasolio
water into fuel filter

09.929.000



luci anabbaglianti
low beams

09.930.000



bassa pressione aria
low air pressure

09.931.000



porta aperta
open door

09.932.000



luce contro flusso
flux control light

09.933.000



presa di forza disinserita
p.t.o. off

09.934.000



indicatori di direzione motrice
tractor's turn signals

09.935.000



indicatori di direzione 1° rimorchio
1st trailer's turn signals

09.936.000



indicatori di direzione 2° rimorchio
2nd trailer's turn signals

09.937.000



verricello
winch

09.938.000



ribaltamento cassone
dump body

09.939.000



ruote sterzanti indipendenti
independent steering wheels

09.940.000



secondo volante
2nd steering wheel

09.942.000



arresto motore
engine stop

09.943.000



bloccaggio differenziale
differential lock

09.944.000



presa di forza anteriore
front power take-off

09.945.000



cinture di sicurezza
safety belt

09.946.000



asse sterzante anteriore
front steering axle

09.947.000



asse sterzante posteriore
rear steering axle

09.948.000



asse sterzante posteriore
rear steering axle

09.949.000



rampe idrauliche
hydraulic ramps

09.950.000



pompa di sentina
bilge pump

09.954.000



presa movimento
power take-off on

09.955.000



asse sterzante anteriore
front steering axle

09.956.000



asse sterzante posteriore
rear steering axle

09.957.000



asse sterzante anteriore
front steering axle

09.958.000



rampe idrauliche
hydraulic ramps

09.960.000



avaria convertitore di tensione
voltage converter failure

09.962.000



indicatore
indicator

09.963.000



preiscaldamento motore
engine preheating

09.0964.0000

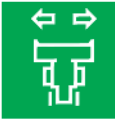

indicatori di direzione mietitrebbia
combine harvester turn signals

09.0965.0000



antiribaltamento
anti-tilting

09.0966.0000



EDC

09.0967.0000



allineamento torretta
turret alignment

09.0968.0000



freno idraulico
hydraulic brake

09.0969.0000



filtro aria
air cleaner

09.0970.0000



cella di carico
load cell

09.0971.0000



allineamento macchina
machine alignment

09.0972.0000



macchina stabilizzata
stabilizer control

09.0973.0000



presenza tensione
power on

09.0974.0000

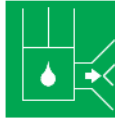

pompa idraulica
hydraulic pump

09.0975.0000



blocco line lock

09.0976.0000



trazione anteriore inserita
front wheel-drive on

09.0977.0000



bloccaggio differenziale
differential lock

09.0979.0000



freno 4x4
4WD brake

09.0980.0000



pressione olio
oil pressure

09.0981.0000



temperatura trasmissione
transmission temperature

09.0982.0000



marcia veloce
fast gear

09.0983.0000



on

09.0984.0000



posteriore
rear

09.0985.0000



trazione integrale 4 WD

09.0986.0000



trazione integrale 4 WD

09.0987.0000



trazione integrale 4 WD

09.0988.0000



pressione olio
oil pressure

09.0989.0000



motore
engine

09.0990.0000



trasmissione
transmission

09.0992.0000



direzione
di marcia
forward/reverse

09.0993.0000



presa di forza
GD P.T.O.

09.0994.0000



ammortizzatore
assale
suspension
front axle

09.0997.0000



presa di forza
anteriore
front P.T.O.

09.0999.0000



presa di forza
anteriore
front P.T.O.

09.1020.0000



fuoco
fire

09.1021.0000



assetto di volo
trim

09.1038.0000



filtro aria intasato
clogged air cleaner

09.1039.0000



pressione olio
idraulico
hydraulic oil
pressure

09.1040.0000



temperatura olio
idraulico
hydraulic oil
temperature

09.1041.0000



pressione olio
oil pressure

• **Segnalatori luminosi 24x24 mm.**

Grado di protezione: IP54
Tensione di alimentazione: 12 o 24V
Materiale lente: Metacrilato
Materiale corpo: Poliammide

• **Warning lights 24x24 mm.**

Sealing: IP54
Power supply voltage: 12 or 24V
Lens material: Methacrylate
Housing material: Polyamide

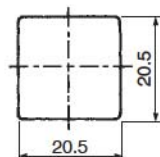
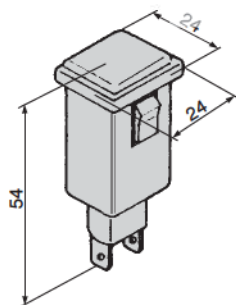

W3W
12V-3W
24V-3W

0002.0246



generatore
battery

0002.0247



riserva
reserve fuel

0002.0248



indicatore di
direzione
turn signal

0002.0249



abbaglianti
high beams

0002.0250



freno a mano
hand brake

0002.0251



neutro
neutral

0002.0252



neutro
neutral

0002.0253



neutro
neutral

0002.0254



neutro
neutral

0002.0259



pressione olio
oil pressure

0002.0261



pressione olio
motore
engine oil
pressure

0002.0262



basso livello
liquido freni
low brake fluid level

0002.0263



retronebbia
rear fog light

0002.0264



bloccaggio
differenziale
posteriore
rear
differential lock

0002.0265



bloccaggio
differenziale
anteriore
front
differential lock

0002.0266



marce ridotte
slow gear

0002.0267



presa di forza
inserita
power take-off on

0002.0268



trazione
integrale
4 WD

0002.0276



luci di ingombro
position lights

0002.0278



emergenza
hazard

0002.0279



periscaldamento
preheating

0002.0280



avaria freni
brakes failure

0002.0281



lampeggiatore
beacon

0002.0284



cassone sollevato
dump body

0002.0287



fendinebbia
fog lights

0002.0290



temperatura
acqua
water
temperature

0002.0291



temperatura olio
oil temperature

0002.0292



filtro aria intasato
clogged air cleaner

0002.0311



avaria freni
a disco
disc brake failure

0002.0472



luci di posizione
position
lights

0002.0473



ventola
fan

0002.0474



ribaltamento cabina
cab's overturn

0002.0475



trazione
anteriore
inserita
front wheel-drive on

0002.0476



filtro olio
intasato
clogged oil filter

0002.0476A



filtro olio idraulico
hydraulic oil filter

0002.0477



frizione presa di
forza
P.T.O. clutch

0002.0495



indicatori di
direzione rimorcho
trailer's turn signals

0002.0508



emergenza
hazard

0002.0509



temperatura olio
oil temperature

0002.0510



rimorcho inserito
trailer on

• **Segnalatori luminosi 30,5x21,3 mm.**

Grado di protezione: IP55
Tensione di alimentazione: 12 o 24V
Materiale lente: Metacrilato
Materiale corpo: Poliammide nero

• **Warning lights 30,5x21,3 mm.**

Sealing: IP55
Power supply voltage: 12 or 24V
Lens material: Methacrylate
Housing material: Black polyamide

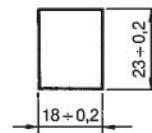
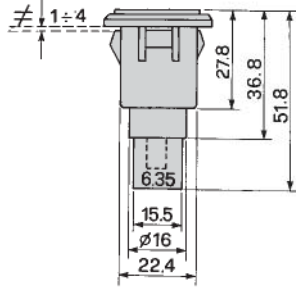
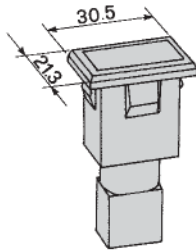

30.33.03401
TAPPO - COVER



W3W
12V-3W
24V-3W

09.200.000



neutro
neutral

09.201.000



freno a mano
inserto
hand brake on

09.202.000



ribaltamento cabina
cab's overturn

09.203.000



emergenza
hazard

09.204.000



bassa pressione
aria ponte
low bridge air pressure

09.205.000



bassa pressione
aria assale
low axle air pressure

09.206.000



bassa pressione
aria freni di
parcheggio
low parking brakes
air pressure

09.207.000



fuori giri
over RPM

09.208.000



inefficienza freni
idraulici
hydraulic brakes
failure

09.209.000



carica generatore
generator load

09.210.000



bassa pressione
olio motore
low engine oil pressure

09.211.000



massima
temperatura acqua
max water
temperature

09.212.000



bassa pressione aria
rimorchio
low trailer air pressure

09.213.000



bloccaggio
differenziale
differential lock

09.214.000



riduttore
epicicloidale
epicyclic reducer

09.215.000



massima
temperatura olio
convertitore
max converter oil
temperature

09.216.000



bassa pressione aria
ponte
low bridge air pressure

09.217.000



filtro olio intasato
clogged oil filter

09.218.000



bloccaggio
differenziale
ponte anteriore
front bridge
differential lock

09.219.000



alta temperatura olio
motore
high engine oil
temperature

09.220.000



neutro
neutral

09.221.000



luci di posizione
position lights

09.222.000



indicatori di
direzione motrice
tractor's turn signals

09.223.000



indicatori di
direzione rimorchio
trailer's turn signals

09.224.000



proiettore illuminazione ralla per semirimorchio
fifth wheel light for semitrailer

09.225.000



neutro
neutral

09.226.000



luci abbaglianti
high beams

09.227.000



neutro
neutral

09.228.000



presa movimento
power take off

09.229.000



trazione posteriore
rear drive

09.230.000



pompa di sentina
bilge pump

09.231.000



pressurizzazione gruppi meccanici
mechanical unit pressurization

09.232.000



retronebbia
rear fog light

09.233.000



neutro
neutral

09.234.000



preriscaldamento motore
engine preheating

09.235.000



riserva carburante
reserve fuel

09.236.000



cassone sollevato
dump body

09.237.000



presa di forza inserita
power take-off on

09.238.000



emergenza
hazard

09.239.000



marcia idraulica inserita
hydraulic gear on

09.240.000



illuminazione generale
master switch

09.241.000



riscaldamento supplementare
additional heating

09.242.000



sollevamento anteriore veicolo
vehicle front lifting

09.243.000



sollevamento posteriore veicolo
vehicle rear lifting

09.244.000



avaria impianto di ventilazione vano motore
engine ventilation system failure

09.245.000



basso livello liquido freni
low brake fluid level

09.246.000



lampada rotante
rotating beacon

09.247.000



trazione anteriore inserita
front wheel-drive on

09.248.000



portellone aperto
open hatch cover

09.249.000



pressione olio trasmissione
transmission oil pressure

09.250.000



livello olio
oil level

09.251.000



temperatura olio cambio
transmission oil temperature

09.252.000



pressione olio trasmissione
transmission oil pressure

09.253.000



riscaldamento supplementare
additional heating

09.254.000



proiettore lavoro
work lamp

09.255.000



ventilazione inserita
ventilating fan

09.256.000



bloccaggio differenziale ponti
bridges differential lock

09.257.000



filtro aria intasato
clogged air cleaner

09.258.000



indicatori di direzione 2° rimorchio
2nd trailer's turn signals

09.259.000



livello olio
oil level

09.260.000



riserva carburante
reserve fuel

09.261.000



trazione anteriore inserita
front wheel-drive on

09.262.000



proiettori ausiliari
auxiliary headlamps

09.263.000



filtro carburante
fuel filter

09.264.000



livello olio motore
engine oil level

09.265.000



freno a mano inserito
hand brake on

09.266.000



avaria freni
brakes failure

09.267.000



neutro
neutral

09.268.000



marcia lenta
slow gear

09.269.000



marcia veloce
fast gear

09.270.000



presa di forza
anteriore
front power
take-off

09.271.000



TEST

09.272.000



bloccaggio sterzata
ponte superiore
upper bridge
steering lock

09.273.000



pompa sterzo in funzione
steering pump engaged

09.274.000



filtro olio idraulico
hydraulic oil filter

09.275.000



BRAKE
PRESSURE

insufficiente
pressione freni
low brake pressure

09.276.000



luci anabbaglianti
low beams

09.277.000



bassa pressione aria
low air pressure

09.278.000



temperatura testa
cilindro
cylinder head
temperature

09.279.000



indicatore di
direzione
turn signal

09.280.000



bloccaggio
differenziale
differential lock

09.281.000



filtro aria intasato
clogged air cleaner

09.282.000



blocco cassone in salita
dump body lock uphill

09.283.000



luci abbaglianti
high beams

09.284.000



luci di posizione
position lights

09.285.000



preriscaldamento
motore
engine preheating

09.289.000



marcia lenta
slow gear

09.290.000



POWER
ON

09.1005.0000



trazione posteriore
rear drive

09.1006.0000



trazione anteriore
inserita
front wheel-drive on

09.1007.0000



marcia lenta
slow gear

09.1008.0000



livello liquido refrigerante
coolant level

09.1009.0000



presa di forza
inserita
power take-off on

09.1010.0000



1° circuito freno
1st brake circuit

09.1011.0000



2° circuito freno
2nd brake circuit

09.1012.0000



motore
engine

09.1013.0000



abs motrice
tractor abs

09.1014.0000



controllo trasmissione
check transmission

09.1015.0000



temperatura
olio trasmissione
transmission oil
temperature

09.1016.0000



presa di forza 1 inserita
P.T.O. 1 on

09.1017.0000



presa di forza 2 inserita
P.T.O. 2 on

09.1018.0000



icona personalizzata
custom icon

09.1024.0000



controllo motore
checking engine

09.1025.0000



icona personalizzata
custom icon

09.1026.0000



icona personalizzata
custom icon

09.1027.0000



icona personalizzata
custom icon

09.1028.0000



icona personalizzata
custom icon

09.1029.0000



icona personalizzata
custom icon

09.1030.0000



icona personalizzata
custom icon

09.1031.0000



icona personalizzata
custom icon

09.1032.0000



icona personalizzata
custom icon

09.1033.0000



icona personalizzata
custom icon

09.1035.0000



icona personalizzata
custom icon

09.1036.0000



icona personalizzata
custom icon

• **Segnalatori luminosi doppi 26x50 mm.**

Grado di protezione: IP43
Tensione di alimentazione: 12 o 24V
Materiale lente: Metacrilato
Materiale corpo: Poliammide nero

• **Double warning lights 26x50 mm.**

Sealing: IP43
Power supply voltage: 12 or 24V
Lens material: Methacrylate
Housing material: Black polyamide



09.195.000
SPIA COMPLETA DI
PORTALAMPADE SENZA VETRINI
WARNING LIGHT WITH
BULB HOLDER WITHOUT LENSES

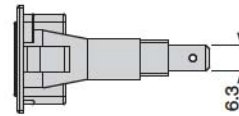
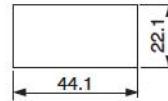
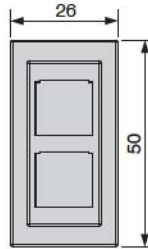
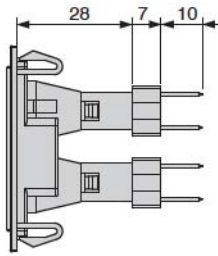

W1,2W
12V-1,2W
24V-1,2W

VETRINO IN METACRILATO - METHACRYLATE LENS

09/3408



presa di forza 540
presa di forza 1000
540 p.t.o.
1000 p.t.o.

09.195.010



stato edc
allarme edc
edc status
edc alarm

09.195.011



sollevatore
neutro
lifter
neutral

09.195.012



aumento giri motore
acceleratore
erpm
boost

09.195.013



indicatore
indicatore
indicator
indicator

09.195.014



indicatore di direzione
indicatore di direzione
turn signal
turn signal

09.195.015



neutro
luci di profondità
neutral
high beams

09.195.016



neutro
generatore
neutral
battery

09.195.017



neutro
pressione olio motore
neutral
engine oil pressure

09.195.018



pressione olio motore
generatore
engine oil pressure
battery

09.195.019



neutro
neutro
neutral
neutral

09.195.020



trazione integrale
trazione integrale
automatica
4WD
auto 4WD

09.195.021



bloccaggio
differenziale
bloccaggio
differenziale
automatico
differential lock
auto differential lock

09.195.022



livello olio
temperatura olio
oil level
oil temperature

09.195.023



alta temperatura
olio cambio
neutro
high transmission
oil temperature
neutral

09.195.024



pressione olio
trasmissione
neutro
transmission
oil pressure
neutral

09.195.025



filtro olio idraulico
neutro
hydraulic oil filter
neutral

09.195.026



indicatore direzione
rimorchio
neutro
trailer's
turn signals
neutral

09.195.027



manutenzione
stop
maintenance
stop

09.195.028



direzione di marcia
neutro
forward/reverse
neutral

09.195.029



neutro
fuoco
neutral
fire

09.195.030



freno di
stazionamento
rimorchio
neutro
trailer parking brake
neutral

09.195.031



temperatura filtro
aria
filtro aria intasato
air cleaner
temperature
clogged air cleaner

09.195.032



freni
filtro aria
brake release
air cleaner

09.195.033



blocco trasmissione
blocco rotazione
transmission lock
swing lock

09.195.034



galleggiamento benna
di carico
loader bucket float

09.195.035



PTO neutro
neutral PTO

09.195.036



PTO galleggiamento
benna di carico RH
PTO loader bucket
float RH

09.195.037



galleggiamento benna
di carico verso l'alto
galleggiamento benna
di carico LH
loader bucket float up
loader bucket float LH

09.195.038



emergenza livello olio
hazard oil level

09.195.039



luci anabbaglianti
luci di profondità
low beams
high beams

09.195.040



generatore
illuminazione generale
battery
parking lights

09.195.041



riserva carburante
pre-riscaldamento
fuel reserve
preheating

09.195.042



neutro
freno a mano inserito
neutral
hand brake on

09.195.043

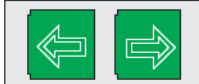

indicatore LH
indicatore RH
indicator LH
indicator RH

09.195.044



neutro
neutral
neutral

09.195.045



luci di profondità
luci di posizione
high beams
position lights

09.195.046



bloccaggio
differenziale
indicatore di direzione
differential lock
direction indicator

09.195.047



filtro aria
filtro olio
air filter
oil filter

VETRINO IN POLICARBONATO - POLYCARBONATE LENS

09.195.500



neutro
porta 1 aperta
neutral
door 1 opener

09.195.501



neutro
porta 2 aperta
neutral
door 2 opener

09.195.502



EDC
temperatura acqua
water temperature

09.195.503



rallentatore
porta 2 aperta
retarder
door 2 opener

09.195.504



porta 2 aperta
porta 1 aperta
door 2 opener
door 1 opener

09.195.505



neutro
chiamata hostess
neutral
hostess call

09.195.506



disabile
chiamata hostess
disabled person
hostess call

09.195.507



usura freni
porta 1 aperta
brake wear
door 1 opener

09.195.508



filtro aria
pre-riscaldamento
air cleaner
preheating

09.195.509



neutro
fuoco
neutral
fire

09.195.510



neutro
pre-riscaldamento
neutral
preheating

• **Segnalatori luminosi 24,6x43,9 mm.**

Grado di protezione: IP67
 Tensione di alimentazione: 12V o 24V
 Temperatura di funzionamento: -40°C ÷ +85°C
 Materiale tasto: Policarbonato nero
 Materiale corpo: Acetalico nero



30.16.06870
 CONNETTORE - CONNECTOR

• **Warning lights 24,6x43,9 mm.**

Sealing: IP67
 Power supply voltage: 12V or 24V
 Operating temperature: -40°C ÷ +85°C
 Rocker material: Black polycarbonate
 Housing material: Black acetal resin

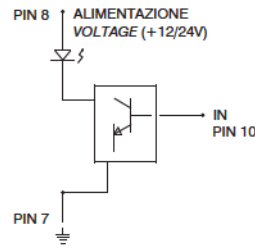
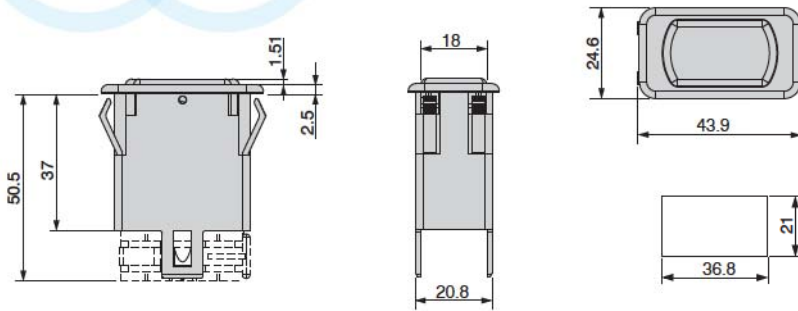

INPUT	L.E.D.
HIGH = OPEN COLLECTOR	ON
LOW = { ≤ 5 V ≤ 20 mA	OFF

09.0287.1010

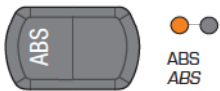

09.0287.1011

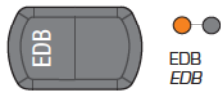

• **Segnalatori luminosi 24,6x43,9 mm.**

Grado di protezione: IP67
 Tensione di alimentazione: 12V o 24V
 Temperatura di funzionamento: -40°C ÷ +85°C
 Materiale tasto: Policarbonato nero
 Materiale corpo: Acetalico nero



30.16.06870
 CONNETTORE - CONNECTOR

• **Warning lights 24,6x43,9 mm.**

Sealing: IP67
 Power supply voltage: 12V or 24V
 Operating temperature: -40°C ÷ +85°C
 Rocker material: Black polycarbonate
 Housing material: Black acetal resin

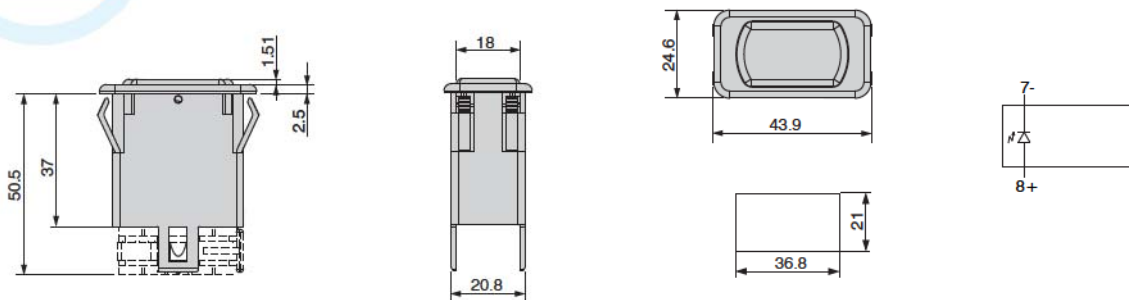

09.0288.1000



09.0288.1001



preiscaldamento
 preheating

09.0288.1002



batteria
 battery

09.0288.1003



freno a mano inserito
 hand brake on

09.0288.1004



filtro aria intasato
 clogged air cleaner

09.0288.1005



blink code

09.0288.1006



preiscaldamento
 preheating

09.0288.1007



allarme motore
 engine alarm

09.0288.1008



gradino aperto
 step open

09.0288.1009



batteria
 battery

09.0288.1010



portello rampa
 sbarco
 ramp door

09.0288.1011



allarme incendio
 vano motore
 engine compartment
 fire alarm

09.0288.1012



esclusione estintore
 extinguisher inhibit

09.0288.1014



indicatori di
 direzione motrice
 tractor's turn signals

09.0288.1015



ON

09.0288.1016



portello rampa aperto
 ramp door open

09.0288.1017



avaria
 riscaldamento ausiliario
 auxiliary heating failure

09.0288.1018



livello combustibile
 fuel level

09.0288.1019



guida LH
 LH drive

09.0288.1020



cestello attivo
 basket on

09.0288.1021



batteria supplementare
 radio scarica
 low radio auxiliary
 battery

09.0288.1022



temperatura
 acqua motore
 engine water
 temperature

09.0288.1023



botola aperta
 trapdoor open

09.0288.1024



pressurizzazione
 pressurization

09.0288.1025



 freno di parcheggio
parking brake

09.0288.1026

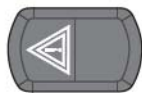

 allarme motore
engine alarm

09.0288.1027



 preriscaldamento
preheating

09.0288.1028

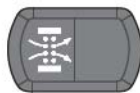

 filtro aria intasato
clogged air cleaner

09.0288.1029

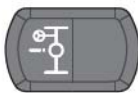

 bloccaggio differenziale
anteriore
front differential lock

09.0288.1030





09.0288.1031



 errore
fault

09.0288.1032



 estintore vuoto
empty extinguisher

09.0288.1033

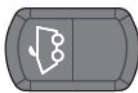

 botola aperta
trapdoor open

09.0288.1034



 filtro nbc
nbc filter

09.0288.1035

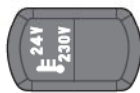

 max temperatura
inverter
inverter max
temperature

09.0288.1036



 ABS

09.0288.1037



 avaria
failure

09.0288.1038

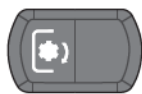

 presa di forza
P.T.O.

09.0288.1039



 RUNIC

09.0288.1040

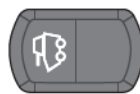

 torre alimentata
power tower

09.0288.1041

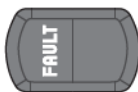

 torre alimentata
power tower

• **Segnalatori luminosi 24,6x43,9 mm.**

Grado di protezione: IP67
Tensione di alimentazione: 12V o 24V
Temperatura di funzionamento: -40°C ÷ +85°C
Materiale tasto: Policarbonato nero
Materiale corpo: Acetalico nero



30.16.06870
CONNETTORE - CONNECTOR

• **Warning lights 24,6x43,9 mm.**

Sealing: IP67
Power supply voltage: 12V or 24V
Operating temperature: -40°C ÷ +85°C
Rocker material: Black polycarbonate
Housing material: Black acetal resin

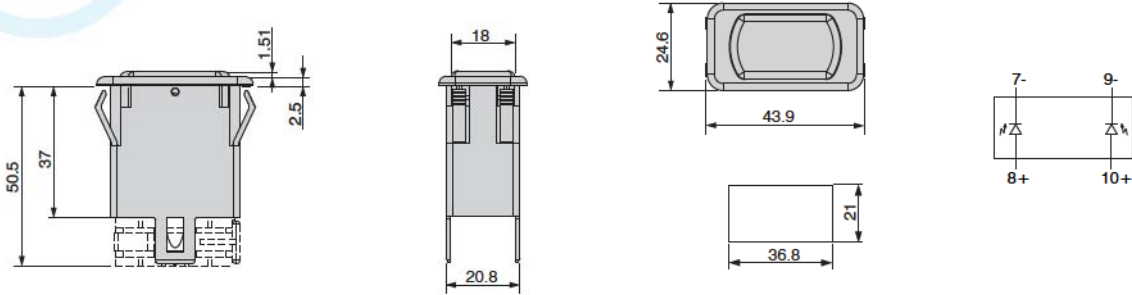

09.0287.1000



●●
indicatore direzione
luci abbaglianti
turn signal
high beams

09.0287.1001

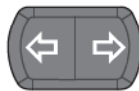

●●
indicatore direzione
indicatore direzione
turn signal
turn signal

09.0287.1002

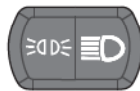

●●
luci di posizione
luci abbaglianti
position lights
high beams

09.0287.1003

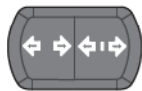

●●
indicatore direzione
indicatore direzione
turn signal
turn signal

09.0287.1004



●●
check
cassone sollevato
check
dump body

09.0287.1005

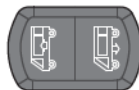

●●
bus alzato
bus abbassato
bus up
bus down

09.0287.1006

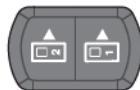

●●
apertura porta 2
apertura porta 1
door 2 opener
door 1 opener

09.0287.1007

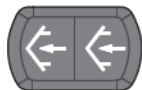

●●
indicatore direzione
indicatore direzione
turn signal
turn signal

09.0287.1008

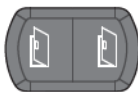

●●
portellone aperto
portellone aperto
open hatch cover
open hatch cover

09.0287.1009



●●
carica generatore
preiscaldamento
general load
preheating

09.0287.1012



●●
freni anteriori
freni posteriori
front brakes
rear brakes

09.0287.1013



●●
livello combustibile
filtro acqua
fuel level
water filter

09.0287.1014



●●
bassa pressione aria servizi
bassa pressione aria
rimorchio
low tools air pressure
low trailer air pressure

09.0287.1015

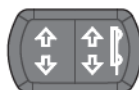

●●
direzione di direzione motrice
direzione di direzione
rimorchio
tractor's turn signal
trailer's turn signal

09.0287.1016



●●
ABS
aria impianto freni
ABS
brake air

09.0287.1017



●●
bassa pressione olio
temperatura acqua motore
low oil pressure
engine water temperature

09.0287.1018



●●
luci di posizione
luci abbaglianti
position lights
high beams

09.0287.1019



●●
batteria
preiscaldamento
battery
preheating

09.0287.1020



●●
adattatore cambio
alta temperatura olio cambio
gear adaptor
high transmission oil
temperature

09.0287.1021



●●
filtro aria intasato
basso livello liquido
clogged air cleaner
low fluid level

09.0287.1022



●●
preiscaldamento
filtro acqua
preheating
water filter

09.0287.1023



●●
porta 2
porta 1
door 2
door 1

09.0287.1024



●●
allarme
preiscaldamento
hazard
preheating

09.0287.1025



●●
preiscaldamento
blink code
preheating

09.0287.1026



1° circuito olio freni
2° circuito olio freni
1st brake circuit
2nd brake circuit

09.0287.1027



liquido freni
freno stazionamento
brake fluid
parking brake

09.0287.1028



pressione olio motore
alta temp. olio motore
engine oil pressure
high engine oil temperature

09.0287.1029



pressione olio trasmissione
alta temp. olio cambio
transmission oil pressure
high transmission oil temperature

09.0287.1030

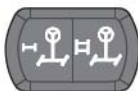

anom. circ. idroguida 1
anom. circ. idroguida 2
hydroguide 1 failure
hydroguide 2 failure

09.0287.1031



rampa alzata
rampa abbassata
ramp up
ramp down

09.0287.1032



termoavviatore
filtro aria intasato
preheater
clogged air cleaner

09.0287.1033



batteria disconnessa
bassa pressione aria
battery off
low air pressure

09.0287.1034



estintore vuoto
estintore abitacolo
empty extinguisher
hull extinguisher

09.0287.1035



estintore vuoto
estintore vano motore
empty extinguisher
engine extinguisher

09.0287.1036



NBC inserito
ventilazione NBC inserito
NBC on
NBC fan

09.0287.1037

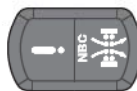

avaria elettrica NBC
filtro NBC intasato
NBC failure
NBC clogged filter

09.0287.1038

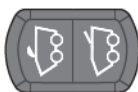

botola aperta
botola aperta
trapdoor open
trapdoor open

09.0287.1039



basso livello acqua motore
temperatura acqua motore
low engine water level
engine water temperature

09.0287.1040



avaria condizionatore
condizionatore
air conditioning failure
air conditioning

09.0287.1041



pressione olio
lubrific. generale
oil pressure
general greasing

09.0287.1042



livello olio
temperatura olio idraulico
oil level
hydraulic oil temperature

09.0287.1043



filtro aria
avaria
air filter
failure

09.0287.1044



livello combustibile
acqua nel gasolio
fuel level
water into fuel

09.0287.1045



preiscaldamento
riscald. carburante
preheating
fuel heating

09.0287.1046

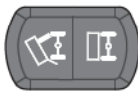

cassone ribaltato
cassone agganciato
dump body
body hooked

09.0287.1047

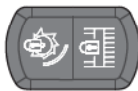

blocc. spazzola
blocc. spazzola centrale
brush lock
central brush lock

09.0287.1048

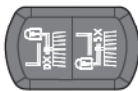

blocc. spazzola RH
blocc. spazzola LH
RH brush lock
LH brush lock

09.0287.1049

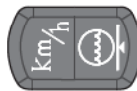

limitatore velocità
livello acqua serbatoio
speed limiting device
water tank level

09.0287.1050



bassa pressione olio
temp. acqua motore
low oil pressure
engine water temperature

09.0287.1051



indicatore direzione
batteria
turn signal
battery

09.0287.1052



luci abbaglianti
luci di posizione
high beams
position lights

09.0287.1053



avaria freni
freno di stazionamento
brakes failure
parking brake

09.0287.1054



freni anteriori
freni posteriori
front brakes
rear brakes

09.0287.1055



guida RH
porta aperta
RH drive
open door

09.0287.1056



marcia veloce
marcia lenta
fast gear
slow gear

09.0287.1057



cestello attivo
corrente inserita
basket on
power on

09.0287.1058

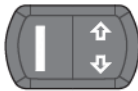

indicatore di direzione
turn signal

09.0287.1059

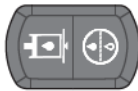

bassa pressione
filtro olio intasato
low pressure
clogged oil filter

09.0287.1060

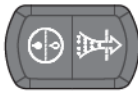

filtro olio intasato
filtro aria intasato
clogged oil filter
clogged air filter

09.0287.1061



batteria
freno di stazionamento
battery
parking brake

09.0287.1062



riserva carburante
filtro olio intasato
reserve fuel
clogged oil filter

09.0287.1063

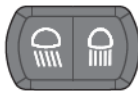

luci anabbaglianti
luci esterne
low beams
high beams

09.0287.1064

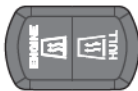

preiscaldamento motore
preiscaldamento abitacolo
engine preheating
hull preheating

09.0287.1065



indicatore di direzione
indicatore di direzione
turn signal
turn signal

09.0287.1066



uscita stabilizzatori
rientro scala
stabilizers control
ladder control

09.0287.1067



emergenza
luci esterne
hazard
external lamps

09.0287.1068



emergenza
abs
hazard
abs

09.0287.1069



motore
preiscaldamento
engine
preheating

09.0287.1070



motore
retronebbia
engine
rear fog light

09.0287.1071



portello rampa aperto
emergenza
ramp door open
hazard

09.0287.1072

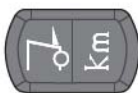

portello rampa sbarco
velocità
ramp door
speed

09.0287.1073



porta 2
porta 1
door 2
door 1

09.0287.1074

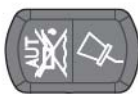

esclusione lubrificazione
aggiungere olio
greasing inhibit
add oil

09.0287.1075



guida LH
avaria trasmissione
LH drive
transmission failure

09.0287.1076



rimorchio inserito
abs
trailer on
abs

09.0287.1077

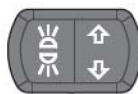

luci di posizione
indicatore direzione
position lights
turn signal

09.0287.1078

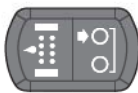

filtro olio intasato
4 ruote motrici
clogged oil filter
4 WD

09.0287.1079

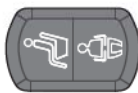

cinture di sicurezza
escluse
allacciate
safety belt
off/on

09.0287.1080

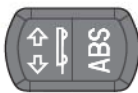

indicatori di direzione
rimorchio
abs
trailer's turn signals
abs

09.0287.1081



on
sensore presenza uomo
man presence
sensor

09.0287.1082

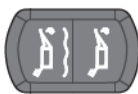

livello olio motore
bassa pressione olio
motore
engine oil level
low engine oil pressure

09.0287.1083

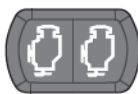

motore
motore
engine
engine

09.0287.1084

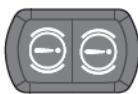

pressione aria
pressione aria
air pressure
air pressure

09.0287.1085

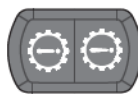

cambio
cambio
gearbox
gearbox

09.0287.1086

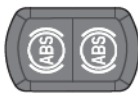

ABS
ABS

09.0287.1087

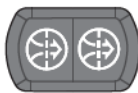

filtro aria
filtro aria
air cleaner
air cleaner

09.0287.1088

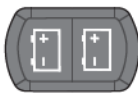

batteria
batteria
battery
battery

09.0287.1089



pressione olio
pressione olio
oil pressure
oil pressure

09.0287.1090

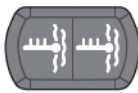

temp. liquido refrig.
temp. liquido refrig.
coolant temperature
coolant temperature

09.0287.1091



abs rimorchio
abs rimorchio
abs towing
abs towing

09.0287.1092

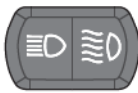

luci abbaglianti / infrarossi
luci abbaglianti / infrarossi
high beam / infrared
high beam / infrared

09.0287.1093

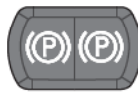

freno di parcheggio
freno di parcheggio
parking brake
parking brake

09.0287.1094

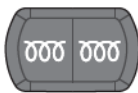

preriscaldamento
preriscaldamento
preheating
preheating

09.0287.1095

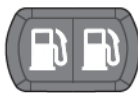

combustibile
combustibile
fuel
fuel

09.0287.1096

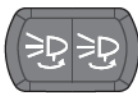

faro da ricerca
faro da ricerca
search light
search light

09.0287.1097

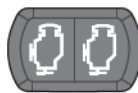

motore
motore
engine
engine

09.0287.1098



sollevamento assale
bassa pressione aria
trailing axle lifting
low air pressure

09.0287.1099



filtro carburante
fuel filter

09.0287.1100



on
errore
on
fault

09.0287.1101



allarme incendio
estintore vuoto
fire alarm
empty extinguisher

09.0287.1102

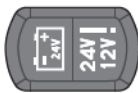

batteria
avaria convertitore di
tensione
battery
voltage converter failure

09.0287.1103

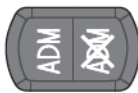

ADM inserito
esclusione ADM
ADM on
ADM inhibit

09.0287.1104

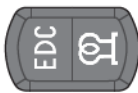

EDC
termoawiatore
EDC
preheater

09.0287.1105



allarme incendio
estintore vuoto
fire alarm
empty extinguisher

09.0287.1106

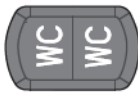

WC
WC

09.0287.1107

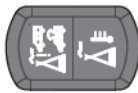

NBC sovrappressione
NBC sovrappressione
NBC high pressure
NBC over temperature

09.0287.1108



NBC filtro intasato
NBC filtro polveri sottili
NBC clogged filter
NBC pm filter

09.0287.1109

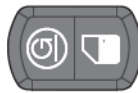

batterie
porte aperte
battery
open door

09.0287.1110

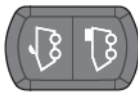

botola pilota aperta
botola mortaio aperta
pilot trapdoor open
mortar trapdoor open

09.0287.1111

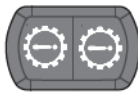

cambio
cambio
gearbox
gearbox

09.0287.1112

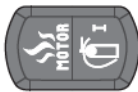

allarme incendio vano motore
estintore vuoto
engine compartment
fire alarm
empty extinguisher

09.0287.1113



allarme incendio
estintore vuoto
fire alarm
empty extinguisher

09.0287.1114



filtra olio intasato
filtra acqua
clogged oil filter
water filter

09.0287.1117



guasto volante
guasto freni
steering system failure
brake system failure

09.0287.1118



sistema emissioni
motore
additivo per emissioni
diesel
engine emissions system
diesel exhaust fluid

09.0287.1119



4X4
controllo motore
4x4
engine check

09.0287.1120



acqua
water

09.0287.1121



4X4
preriscaldamento
4x4
preheating

09.0287.1122



guasto motore
cinghia
engine fault
belt

09.0287.1123



batteria
bassa carica batteria
battery
low battery

09.0287.1124



pressione olio
alta temp. olio motore
oil pressure
high engine
oil temperature

09.0287.1125



icona personalizzata
alta temperatura olio
cambio
custom icon
high transmission oil
temperature

09.0287.1126

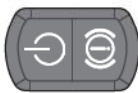

ON
avaria freni
ON
brakes failure

09.0287.1127



HIGH
MED
HIGH
MED

09.0287.1128



fuoco
estintore vuoto
fire
empty extinguisher

09.0287.1129



ON
AVARIA
ON
AVARIA

09.0287.1130

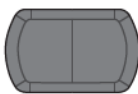

neutro
neutral

09.0287.1131

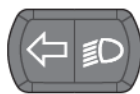

indicatore direzione
luci anabbaglianti
turn signal
low beams

09.0287.1132

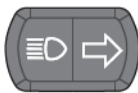

luci abbaglianti
indicatore direzione
high beams
turn signal

09.0287.1133



CHECK
OIL
CHECK
OIL

09.0287.1134



attivazione filtro
antiparticolato
temperatura filtro
particulate filter
regeneration
filter temperature

09.0287.1135

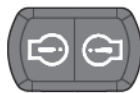

allarme motore
allarme motore
engine alarm
engine alarm

09.0287.1136

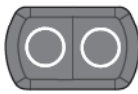

icona personalizzata
custom icon

09.0287.1137



icona personalizzata
custom icon

09.0287.1138

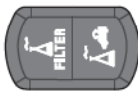

icona personalizzata
custom icon

09.0287.1139

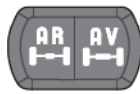

icona personalizzata
custom icon

09.0287.1140

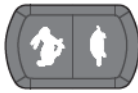

marcia veloce
marcia lenta
fast gear
slow gear

09.0287.1141



filtra olio idraulico
freno di stazionamento
hydraulic oil filter
parking brake

09.0287.1142

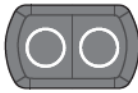

icona personalizzata
custom icon

09.0287.1143



batteria
pressione olio
battery
oil pressure

09.0287.1144

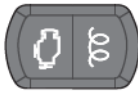

motore
preriscaldamento
engine
preheating

09.0287.1145

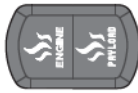

allarme incendio
allarme incendio
fire alarm
fire alarm

09.0287.1146



motore
LPG
engine
LPG

09.0287.1147

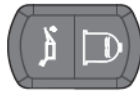

pressione olio
filtra acqua
oil pressure
water filter

09.0287.1148

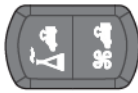

icona personalizzata
custom icon

- **Segnalatori luminosi 24,6x43,9 mm. con resistenza in parallelo ai led**

Grado di protezione: IP67
 Tensione di alimentazione: 12V o 24V
 Temperatura di funzionamento: -40°C ÷ +85°C
 Materiale tasto: Policarbonato nero
 Materiale corpo: Acetalico nero



30.16.06870
 CONNETTORE - CONNECTOR

- **Warning lights 24,6x43,9 mm. resistor connected in parallel with leds**

Sealing: IP67
 Power supply voltage: 12V or 24V
 Operating temperature: -40°C ÷ +85°C
 Rocker material: Black polycarbonate
 Housing material: Black acetal resin

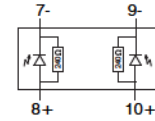
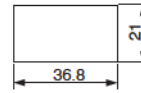
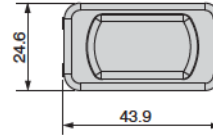
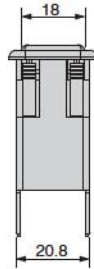
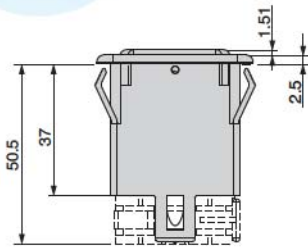

09.0287.1115

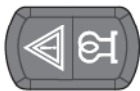

allarme
 preriscaldamento
 hazard
 preheating

09.0287.1116



OBD
 DPF

• **Segnalatori luminosi doppi 48x24 mm.**

Grado di protezione: IP65
Tensione di alimentazione: 12 o 24V
Colore simboli: Bianco
Materiale lente: Metacrilato colorato
Materiale corpo: Poliammide nero

• **Double warning lights 48x24 mm.**

Sealing: IP65
Power supply voltage: 12 or 24V
Symbols color: White
Lens material: Colored methacrylate
Housing material: Black polyamide

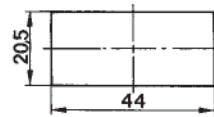
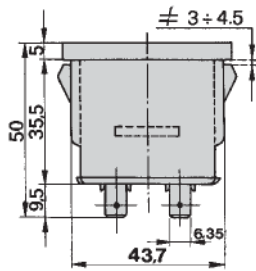
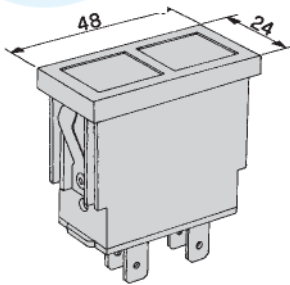

T4W
12V-3W
24V-3W

30.33.05023
TAPPO - COVER

09.300.000



neutro
neutral

09.301.000



riserva carburante
carica generatore
fuel reserve
generator load

09.302.000



pressione olio motore
riserva carburante
engine oil pressure
fuel reserve

09.303.000



carica generatore
luci di posizione
generator load
position lights

09.304.000



carica generatore
pressione olio motore
generator load
engine oil pressure

09.305.000



riserva carburante
alta temperatura
olio motore
fuel reserve
high engine oil
temperature

09.306.000



luci di profondità
carica generatore
high beams
generator load

09.307.000



pressione olio motore
indicatore di
direzione
engine oil pressure
turn signal

09.308.000



carica generatore
indicatore di
direzione
generator load
turn signal

09.309.000



indicatore di
direzione
luci di profondità
turn signal
high beams

09.310.000



indicatore di direz.
1° rimorchio
indicatore di direz.
2° rimorchio
1st trailer turn
signal
2nd trailer
turn signal

09.311.000



indicatore di direz.
indicatore di direz.
1° rimorchio
turn signal
1st trailer
turn signal

09.312.000

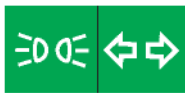

luci di posizione
indicatore di
posizione
position lights
turn signal

09.313.000



pressione olio motore
luci di profondità
engine oil pressure
high beams

09.314.000



luci di profondità
riserva carburante
high beams
fuel reserve

09.315.000



termoavviatore
indicatore di
direzione
preheater
turn signal

09.316.000



termoavviatore
temperatura
liquido raffredd.
preheater
cooling liquid
temperature

09.317.000



luci anabbaglianti
luci abbaglianti
low beams
high beams

09.318.000



presa movimento
filtro aria
power take-off
air cleaner

09.319.000



indicatore di
direzione
presa movimento
turn signal
power take-off

09.320.000



pressione olio motore
engine oil pressure

09.321.000



riserva carburante
termoavviatore
fuel reserve
preheater

09.322.000



avaria freni
lockup
brake failure
lockup

09.323.000



termoavviatore
termoavviatore
preheater
preheater

09.324.000



riserva carburante
filtro olio idraulico
fuel reserve
hydraulic oil filter

09.325.000



bassa
pressione aria
filtro aria intasato
low air pressure
clogged air cleaner

09.326.000



bassa
pressione aria
riserva carburante
low air pressure
fuel reserve

09.327.000



pressione olio motore
temperatura
liquido raffredd.
engine oil pressure
cooling liquid
temperature

09.328.000



termoavviatore
filtro olio idraulico
preheater
hydraulic oil filter

09.329.000



indicatore
di direzione
neutro
turn signal
neutral

09.330.000



temperatura olio
cambio
carica generatore
transmission oil
temperature
generator load

09.331.000



termoavviatore
filtro aria
preheater
air cleaner

09.332.000



indicatore
di direzione
proiettore da lavoro
turn signal
worklamp

09.333.000



freno a mano
inserto
trazione anteriore
inserita
hand brake on
front wheel-drive on

09.334.000



riserva carburante
neutro
fuel reserve
neutral

09.335.000



neutro
neutro
neutral
neutral

09.336.000



termoavviatore
bassa pressione
aria freni
preheater
low brakes
air pressure

09.337.000



neutro
neutro
neutral
neutral

09.338.000



riserva carburante
neutro
fuel reserve
neutral

09.339.000



fanale illuminazione
braccio escavatore
neutro
boom lights
neutral

09.340.000



attivazione martello
pneumatico
proiettore orient.
pneumatic hammer
control
swivel headlight

09.341.000



filtro aria
carica generatore
air cleaner
generator load

09.342.000



pressione olio
motore
preiscaldamento
engine oil
pressure
preheating

09.343.000



neutro
neutro
neutral
neutral

09.344.000



carica generatore
neutro
generator load
neutral

09.345.000



bassa pressione
aria ponte
neutro
low bridge air pressure
neutral

09.346.000



temperatura liquido
raffreddamento
neutro
cooling liquid
temperature
neutral

09.347.000



freno a mano inserto
basso livello
liquido freni
hand brake on
low brake fluid level

09.348.000



idroguida
luci abbaglianti
hydroguide
high beams

09.349.000



carica generatore
bassa pressione
aria freni
generator load
low brakes
air pressure

09.353.000

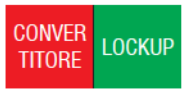

convertitore
lock up
converter
lock up

09.354.000



carica generatore
freno a mano
inserto
generator load
hand brake on

09.355.000



riserva carburante
filtro olio idraulico
fuel reserve
hydraulic oil filter

09.356.000



luci di profondità
neutro
high beams
neutral

09.357.000



saracinesca aperta
saracinesca chiusa
open gate
closed gate

09.358.000



liv. olio serb. pompa
idraul. / pres. olio
pompa idrostatica
hydraulic pump
tank oil level
hydrostatic
pump oil pressure

09.359.000



luci di profondità
fuori giri
high beams
over RPM

09.360.000



fuori giri
indicatore di
direzione
over RPM
turn signal

09.361.000



pressione olio
motore
filtro olio intasato
engine oil pressure
clogged oil filter

09.362.000



bassa pressione
aria freni
pres. olio motore
low brakes air pressure
engine oil pressure

09.363.000



indicatore di
direzione
freno a mano
inserto
turn signal
hand brake on

09.364.000



temperatura olio cambio
bassa pressione
olio cambio
transmission oil
temperature
low transmission oil
pressure

09.365.000



temperatura
olio idraulico
filtro olio idraulico
hydraulic oil
temperature
hydraulic oil filter

09.366.000



luci di posizione
luci di profondità
position lights
high beams

09.367.000



luci anabbaglianti
neutro
low beams
neutral

09.368.000



neutro
luci di profondità
neutral
high beams

09.369.000



bloccaggio
differenziale
presa movimento
differential lock
power take-off

09.370.000



filtro aria anteriore
filtro aria posteriore
front air cleaner
rear air cleaner

09.371.000



luci anabbaglianti
termoavviatore
low beams
preheater

09.372.000



servofreno 1 asse
servofreno 2 asse
powerbrake 1st axle
powerbrake 2nd axle

09.373.000



pompa principale
pompa ausiliaria
main pump
auxiliary pump

09.374.000



alta temp. olio motore
pressione olio motore
high engine oil temperature
engine oil pressure

09.375.000



filtro aria
elettroventilatore
air cleaner
electric fan

09.376.000



pres. olio motore
riscaldamento interno
engine oil pressure
heating

09.377.000



freno a mano inserito
blocco avv. con marcia inserita
hand brake on
starter lock with engaged gear

09.378.000



riserva carburante
temperatura olio idraulico
fuel reserve
hydraulic oil temperature

09.379.000



riserva carburante
riscaldamento interno
fuel reserve
heating

09.380.000



temperatura olio cambio
riserva carburante
transmission oil temperature
fuel reserve

09.381.000



distacco trasmissione
temperatura olio idraulico
transmission declutch
hydraulic oil temperature

09.382.000



filtro aria intasato
riscald. interno
clogged air cleaner
heating

09.383.000



filtro olio idraulico
filtro aria intasato
hydraulic oil filter
clogged air cleaner

09.384.000



temperatura liquido raffredd.
freno a mano inserito
cooling liquid temperature
hand brake on

09.386.000



indicatore direzione
1° rimorchio neutro
1st trailer's turn signal
neutral

09.387.000



neutro
freno a mano inserito
neutral
hand brake on

09.388.000



pompa neutro
pump neutral

09.389.000



bassa pressione aria neutro
low air pressure neutral

09.390.000



blocco idraulico
filtro aria intasato
hydraulic lock
clogged air cleaner

09.391.000



alta temp. olio motore
filtro aria intasato
high engine oil temperature
clogged air cleaner

09.392.000



carica generatore neutro
generator load neutral

09.393.000



neutro
neutro
neutral

09.400.000



indicatore di direzione neutro
turn signal neutral

09.401.000



luci di posizione
luci abbaglianti
position lights
high beams

09.402.000



carica generatore
riserva carburante
generator load
fuel reserve

09.404.000



riserva carburante
temperatura liquido raffredd.
fuel reserve
cooling liquid temperature

09.405.000



lampada rotante
bloccaggio differenziale
rotating beacon
differential lock

09.406.000



emergenza
luci di posizione
hazard
position lights

09.408.000



presa di forza inserita
cassone ribaltato
power take-off on
dump body

09.409.000



indicatore di direzione
bassa pressione aria assiale
turn signal
low axle air pressure

09.410.000



bassa pres. aria assale
bassa pres. aria ponte
low axle air pressure
low bridge air pressure

09.411.000



luce retromarcia
indicatore di direzione
reversing lamp
turn signal

09.412.000



emergenza
freno manovra
hazard
operator brake

09.413.000



preriscaldamento
termoavviatore
preheating
preheater

09.414.000



luce retronebbia
preriscaldamento
rear fog light
preheating

09.415.000



pompa emergenza
freno manovra
emergency pump
operator brake

09.419.000



emergenza
filtro olio
hazard
oil filter

09.420.000



allarme motore
arresto motore
emergenza
engine alarm
emergency engine shutdown

09.421.000



avaria freni neutro
brakes failure
neutral

09.422.000



emergenza
avaria freni
hazard
brakes failure

09.423.000



preriscaldamento
blocco
preheating
lock up

09.424.000



filtro olio intasato
neutro
clogged oil filter
neutral

09.425.000



termoavviatore
idroguida
preheater
hydroguide

09.426.000



filtro aria intasato
neutro
clogged air cleaner
neutral

09.427.000



neutro
neutro
neutral
neutral

09.428.000



termoavviatore
neutro
preheater
natural

09.429.000



preriscaldamento
avaria freni
preheating
brakes failure

09.430.000



filtro olio
intasato
freno manovra
clogged oil
filter
operator brake

09.431.000



retronebbia
emergenza
rear fog light
hazard

09.432.000



freno a mano
inserito
filtro olio idraulico
hand brake on
hydraulic oil filter

09.433.000



tramoggia piena
tramoggia vuota
full hopper
empty hopper

09.435.000



freno rimorchio
neutro
trailer brake
neutral

09.436.000



carica generatore
4 ruote motrici
generator load
4 WD

09.437.000



carica generatore
preriscaldamento
generator load
preheating

09.438.000



presa movimento
filtro olio idraulico
power take-off
hydraulic oil filter

09.439.000



neutro
neutro
neutral
neutral

09.440.000



pressione olio
idraulico
freno rimorchio
hydraulic oil
pressure
trailer brake

09.441.000



freno rimorchio
presa di forza
trailer brake
power take-off

09.442.000



marcia lenta
marcia veloce
slow gear
fast gear

09.443.000



filtro carburante
neutro
fuel filter
neutral

09.444.000



filtro olio motore
livello olio motore
engine oil filter
engine oil level

09.445.000



indicatore di
direzione
turn signal

09.446.000



temperatura gas
di scarico
manutenzione
exhaust emission
temperature
maintenance

09.449.000



LOAD
INDIC
FORK
COMP

09.582.000



giri motore
acceleratore
rpm
boost

09.583.000



livello carburante
preriscaldamento
fuel level
preheating

09.584.000



pressione olio
riserva carburante
oil pressure
fuel reserve

09.585.000



filtro aria intasato
filtro olio
clogged air
oil filter

09.586.000



presa di forza inserita
filtro aria intasato
PTO on
clogged air cleaner

09.951.000



blocco
neutro
lock
neutral

09.0998.0000



temperatura olio
idraulico
neutro
hydraulic oil temperature
neutral

0002.0039



temperatura olio
freno di parcheggio
oil temperature
parking brake

0002.0040



cassone ribaltato
ribaltamento cabina
dump body
cab's overturn

0002.0041



olio trasmissione
olio trasmissione
transmission oil
transmission oil

0002.0042



preriscaldamento
ventola
preheating
fan

0002.0045



indicatore DX
indicatore SX
RH indicator
LH indicator

0002.0055



riserva
luci di posizione
fuel reserve
position lights

0002.0056



pressione olio
luci di posizione
oil pressure
position lights

0002.0057



luci anabbaglianti
preriscaldamento
low beams
preheating

0002.0058



riserva
cassone sollevato
fuel reserve
dump body

0002.0059



luci anabbaglianti
freno di parcheggio
low beams
parking brake

0002.0060



riserva
bloccaggio differenziale
fuel reserve
differential lock

0002.0063



pressione olio
freno di parcheggio
oil pressure
parking brake

0002.0066



riserva
freno di parcheggio
fuel reserve
parking brake

0002.0068



abbaglianti
neutro
high beams
neutral

0002.0070



indicatore direzione
filtro olio intasato
turn signal
clogged oil filter

0002.0071



riserva
indicatore direzione
fuel reserve
turn signal

0002.0072



riserva
preriscaldamento
fuel reserve
preheating

0002.0076



generatore
pressione
olio motore
*battery
engine oil pressure*

0002.0082



bloccaggio differenziale
neutro
*differential lock
neutral*

0002.0083



indicatore direzione
preiscaldamento
*turn signal
preheating*

0002.0084



indicatore direzione
cassone sollevato
*turn signal
dump body*

0002.0085



temperatura acqua
preiscaldamento
*water temperature
preheating*

0002.0086



freno di parcheggio
preiscaldamento
*parking brake
preheating*

0002.0087



indicatore direzione
avaria freni
*turn signal
brakes failure*

0002.0089



riserva
temp. olio trasmissione
*fuel reserve
transmission
oil temperature*

0002.0090



avaria freni
preiscaldamento
*brakes failure
preheating*

0002.0099



temperatura acqua
preiscaldamento
*water temperature
neutral*

0002.0105



indicatore direzione
temperatura acqua
*turn signal
water temperature*

0002.0112



avaria freni
freno di parcheggio
*brakes failure
parking brake*

0002.0113



riserva
avaria freni
*fuel reserve
brakes failure*

0002.0114



abbaglianti
filtro olio intasato
*high beams
clogged oil filter*

0002.0115



PRES.
OLIO (P)
pressione olio
freno di parcheggio
*oil pressure
parking brake*

0002.0134



riserva
ventola
*fuel reserve
fan*

0002.0135



filtro olio intasato
neutro
*clogged oil filter
neutral*

0002.0138



abbaglianti
surriscaldamento
motore
*high beams
engine overheating*

0002.0146



indicatore direzione
neutro
*turn signal
neutral*

0002.0147



preiscaldamento
presa di forza
*preheating
P.T.O.*

0002.0155



lampada rotante
ventola
*rotating beacon
fan*

0002.0158



cassone sollevato
rimorchio inserito
*dump body
trailer on*

0002.0157



cassone sollevato
indicatore direzione
*dump body
turn signal*

09/2273



riserva carburante
indicatore direzione
*fuel reserve
turn signal*

• **Segnalatori luminosi doppi 48x24 mm.**

Grado di protezione: IP65
Tensione di alimentazione: 12 o 24 V
Colore simboli: Nero
Materiale lente: Metacrilato
Materiale corpo: Poliammide

• **Double warning lights 48x24 mm.**

Sealing: IP65
Power supply voltage: 12 or 24V
Symbols color: Black
Lens material: Methacrylate
Housing material: Polyamide

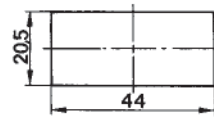
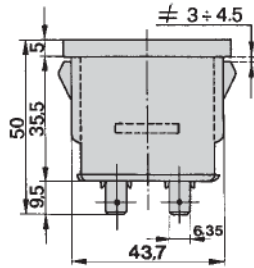
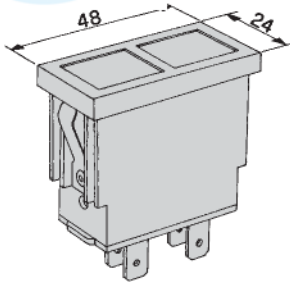

T4W
12V-3W
24V-3W

30.33.05023
TAPPO - COVER

09.350.000



carica batteria
riserva carburante
battery load
fuel reserve

09.351.000



indicatori direzione
filtro aria intasato
turn signal
clogged air cleaner

09.352.000



luci di posizione
luci di profondità
position lights
high beams

09.394.000



preriscaldamento
filtro aria
preheating
air cleaner

09.396.000



pressione olio
temperatura acqua
oil pressure
water temperature

09.397.000



preriscaldamento
temperatura
olio cambio
preheating
transmission oil
temperature

09.398.000



indicatore direzione
freno a mano
inserito
turn signal
hand brake on

09.399.000



chiave inserita
contatto di
sicurezza disinserito
key on
safety contact
disconnected

09.403.000



indicatore direzione
bassa pressione aria
turn signal
low air pressure

09.407.000



alta temperatura
pannello pompa
freno a mano inserito
pump panel high
temperature
hand brake on

09.417.000



usura freni
neutro
brakes wear
neutral

09.418.000



indicatore direzione
neutro
turn signal
neutral

09.434.000



chiave inserita
neutro
key on
neutral

09.447.000



cinture di sicurezza
neutro
safety belt
neutral

09.448.000



usura freni
cinture di sicurezza
brakes wear
safety belt

09.959.000



usura freni
freno di parcheggio
brakes wear
parking brake

09.961.000



filtro olio idraulico
intasato
usura freni
clogged hydraulic
oil filter
brake wear

09.0995.0000



avaria sistema
rifornimento
arresto motore
emergenza
fuel system failure
emergency
engine stop

09.0996.0000



neutro
arresto motore
emergenza
neutral
emergency
engine stop

09.1022.0000



sistema emissioni
motore
additivo per emissioni
diesel
engine emissions system
diesel exhaust fluid

• **Segnalatori luminosi multipli 106x28 mm.**

Grado di protezione: IP53
Tensione di alimentazione: 12 o 24V
Materiale lente: Metacrilato
Materiale corpo: Poliammide

• **Multiple warning lights 106x28 mm.**

Sealing: IP53
Power supply voltage: 12 or 24V
Lens material: Methacrylate
Housing material: Polyamide

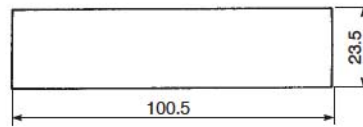
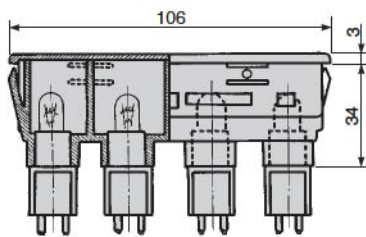

W3W
12V-3W
24V-3W

09.005.000



selezione marce
gearshift

09.007.000



selezione marce - riserva carburante
gearshift - fuel reserve

09.055.000



pressione olio trasmissione - livello olio trasmissione -
neutro - riserva carburante
transmission oil pressure - transmission oil level -
neutral - fuel reserve

09.056.000



bloccaggio differenziale - proiettore lavoro
livello olio motore - trazione anteriore inserita
differential lock - work lamp engine oil level -
front drive on

09.058.000



carica generatore - pressione olio -
luci di profondità - anabbaglianti
generator load - oil pressure - high beams - low beams

09.059.000

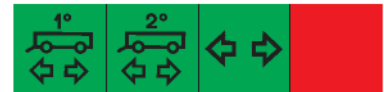

indicatori di direzione 1° rimorchio - indicatori di direzione
2° rimorchio - indicatore di direzione - neutro
1st trailer turn signals - 2nd trailer turn signals -
turn signal - neutral

09.067.000



presa di forza inserita - cassone sollevato -
luce retronebbia - luce fendinebbia
power take-off on - dump body - rear fog light - fog light

09.068.000



luci di profondità - luci di posizione - luci di emergenza -
freno a mano inserito
high beams - position lights - hazard lights - hand brake on

09.069.000



indicatore di direzione - luce retronebbia - starter -
carica generatore
turn signal - rear fog light - starter - generator load

09.071.000



brillatore escluso - innesto trinciapaglia -
filtro olio idraulico - livello olio serbatoio idrostatico
centrifuge off - straw chopper engaged -
hydraulic oil filter - hydrostatic tank oil level

09.072.000



luci emergenza - massima temperatura acqua -
preriscaldamento - freno a mano inserito
hazard lights - max water temperature -
preheating - hand brake on

09.077.000



carica generatore - pressione olio motore -
temperatura olio convertitore - filtro aria intasato
generator load - engine oil pressure - converter oil
temperature - clogged air cleaner

09.078.000



luci di posizione - indicatore di direzione - freno a mano inserito - trazione anteriore inserita
position lights - turn signal - hand brake on - front drive on

09.145.000



carica generatore - bassa pressione olio motore - luci di ingombro - luci di profondità
generator load - low engine oil pressure - side marker lamps - high beams

09.152.000



luci di posizione - luci abbaglianti - fendinebbia - retronebbia
position lights - high beams - fog lights - rear fog light

09.156.000



pressione olio idraulico - livello olio serbatoio idrostatico - temperatura olio circuito idrostatico - filtro olio circuito idrostatico
hydraulic oil pressure - hydrostatic tank oil level - hydrostatic circuit oil temperature - hydrostatic circuit oil filter

09.161.000



marcia veloce - marcia media - marcia lenta - neutro
high - medium - low - neutral

09.169.000



trazione anteriore inserita - freni rimorchio - pressione olio pompa idrostatica - bloccaggio differenziale
front drive on - trailer brake - hydrostatic pump oil pressure - differential lock

09.176.000



indicatore direzione - cassone sollevato - abbaglianti - rallentatore
turn signal - dump body - high beams - retarder

09.183.000



indicatore sx - abbaglianti - freno di stazionamento - indicatore dx
left indicator - high beams - parking brake - right indicator

09.140.000



emergenza - sganciamento rimorchio - preriscaldamento motore - freno di manovra inserito
hazard - trailer unhooking - engine preheating - operator brake

09.149.000



riserva carburante - indicatore direzione - indicatore - indicatore
fuel reserve - turn signal - indicator - indicator

09.154.000



pressione olio idraulico - freno di parcheggio - riserva combustibile - neutro
hydraulic oil pressure - parking brake - fuel reserve - neutral

09.157.000



carica generatore - bassa pressione olio motore - massima temperatura acqua - preriscaldamento
generator load - low engine oil pressure - max water temperature - engine preheating

09.163.000



press. olio pompa idrostatica - freni rimorchio - neutro - riserva carburante
hydrostatic pump oil pressure - trailer brakes - neutral - fuel reserve

09.170.000



carica generatore - bloccaggio differenziale - scuotipaglia - indicatori di direzione
generator load - differential lock - shaker - turn signal

09.177.000



regolazione serranda - rotazione aspo - filtro aria intasato - indicatore direzione
shutter control - swift rotation - clogged air cleaner - turn signal

09.184.000



carica generatore - pressione olio - filtro aria intasato - preriscaldamento
general load - oil pressure - clogged air cleaner - preheating

09.144.000



riserva carburante - direzione motrice - freno a mano inserito - luci emergenza
fuel reserve - tractor's turn signals - hand brake on - hazard lights

09.150.000



carica generatore - bassa pressione olio motore - preriscaldamento motore - freno a mano inserito
generator load - low engine oil pressure - engine preheating - hand brake on

09.155.000



luci di posizione - luci abbaglianti - indicatori di direzione motrice - indicatori di direzione rimorchio
position lights - high beams - tractor's turn signals - trailer's turn signals

09.160.000



bloccaggio differenziale - proiettore lavoro - freni rimorchio - trazione anteriore inserita
differential lock - work lamp - trailer brakes - front drive on

09.165.000



preriscaldamento - massima temperatura acqua - temperatura olio circuito idrostatico - bassa pressione olio motore
preheating - max water temperature - hydrostatic circuit oil temperature - low engine oil pressure

09.175.000



carica generatore - trazione integrale - presa movimento - indicatore di direzione
generator load - 4 WD - power take-off - turn signal

09.182.000



olio freni idraulici - temperatura acqua - pressione olio motore - carica batteria
hydraulic brakes oil - water temperature - engine oil pressure - battery load

09.185.000



temperatura olio - pressione olio idraulico - freno di stazionamento - neutro
oil temperature - hydraulic oil pressure - parking brake - neutral

09.186.000



indicatori di direzione - basso livello liquido freni - anabbaglianti - abbaglianti
turn signals - low brake fluid level - low beams - high beams

09.190.000



temperatura olio circuito idrostatico - pressione olio idraulico - freno di stazionamento - neutro
hydrostatic circuit oil temperature - hydraulic oil pressure - parking brake - neutral

09.193.000



indicatore sx - presa di forza - abbaglianti - indicatore dx
left indicator - power take off - high beams - right indicator

09.953.000



indicatori di direzione - bloccaggio differenziale - eas - neutro
turn signal - differential lock - eas - neutral

09.0296.0000



pressione olio motore - carica generatore - alta temperatura olio convertitore - pressione olio trasmissione
engine oil pressure - generator load - high converter oil temperature - transmission oil pressure

09.1201.0000



luci di posizione - luci di profondità - indicatore di direzione motrice - indicatore di direzione carrello
position lights - high beams
tractor's turn signals - trailer's turn signals

09.0317.0000



indicatori di direzione - freno a mano inserito - carica generatore - luci abbaglianti
turn signals - hand brake on - generator load - high beams

09.188.000



stop

09.191.000



indicatori di direzione - pressione olio freni - luci di posizione - abbaglianti
turn signals - brake oil pressure - position lights - high beams

09.197.000



luci di profondità - freno a mano inserito - indicatore di direzione - preriscaldamento motore
high beams - hand brake on - turn signal - engine preheating

09.0292.0000



indicatore sx - abbaglianti - emergenza - indicatore dx
left indicator - high beams - hazard - right indicator

09.0299.0000



abs - abs rimorchio - freno a mano inserito - rallentatore
abs - abs towing - hand brake on - retarder

09.1023.0000



neutro - neutro - massima temperatura acqua - riserva carburante
neutral - neutral - max water temperature - fuel reserve

09.0318.0000



riserva carburante - temperatura olio circuito idrostatico - indicatori di direzione - rpm costanti
fuel reserve - hydrostatic circuit oil temperature - turn signals - constant rpm

09.189.000



carica generatore - pressione olio motore - filtro aria intasato - preriscaldamento motore
generator load - engine oil pressure - clogged air cleaner - engine preheating

09.192.000



abbaglianti - anabbaglianti - luci di posizione - indicatori di direzione
high beams - low beams - position lights - turn signal

09.198.000



filtro aria intasato - livello acqua serbatoio - portellone aperto - cassone pieno
clogged air cleaner - water tank level - open door - full body

09.0295.0000



direzione avanti - direzione indietro - bloccaggio sospensioni anteriori - bloccaggio sospensioni posteriori
forward direction - backward direction - front wheel suspensions lock - rear wheel suspensions lock

09.1200.0000



bloccaggio differenziale ponti - trazione anteriore inserita - fendinebbia - retronebbia
bridges differential lock - front drive on - fog light - rear fog light

09.0316.0000



filtro acqua - pressione olio motore - temperatura acqua - filtro aria intasato
water filter - engine oil pressure - water temperature - clogged air cleaner

• **Segnalatori luminosi multipli 99,5x65 mm.**

Grado di protezione: IP54
Tensione di alimentazione: 12 o 24V
Materiale lente: Metacrilato
Materiale corpo: ABS

• **Multiple warning lights 99,5x65 mm.**

Sealing: IP54
Power supply voltage: 12 or 24V
Lens material: Methacrylate
Housing material: ABS

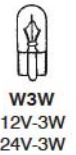
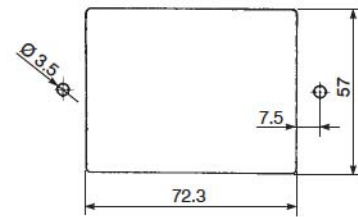
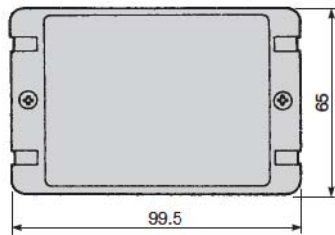
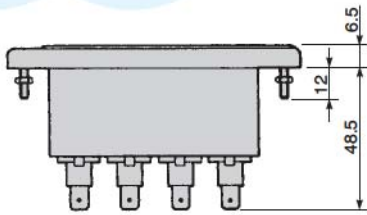

0002.0270

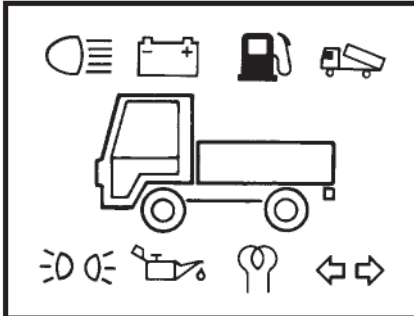

abbaglianti - generatore - riserva carburante - cassone sollevato - luci di posizione - pressione olio - preriscaldamento - indicatore di direzione
high beams - generator - fuel reserve - dump body - position lights - oil pressure - preheating - turn signal

0002.0271

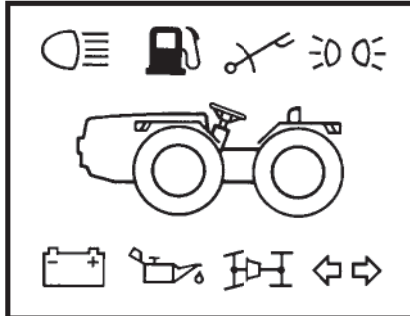

abbaglianti - riserva carburante - freno a mano inserito - luci di posizione - generatore - pressione olio - trazione anteriore - indicatore di direzione
high beams - fuel reserve - handbrake on - position lights - generator - oil pressure - front drive on - turn signal

0002.0272

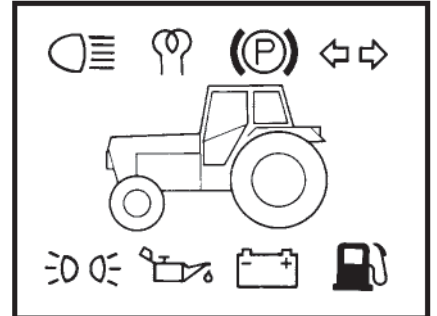

abbaglianti - preriscaldamento - freno di stazionamento - indicatore direzione - luci di posizione - pressione olio - generatore - riserva carburante
high beams - preheating - parking brake - turn signal - position lights - oil pressure - generator - fuel reserve

0002.0273

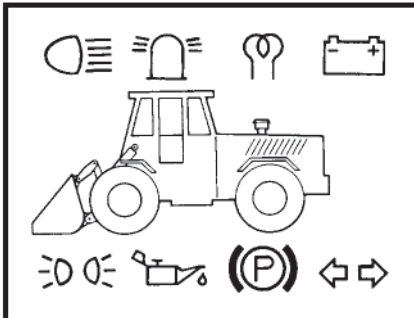

abbaglianti - faro rotante - preriscaldamento - luci di posizione - pressione olio - freno di stazionamento - indicatore direzione
high beams - rotating beacon - preheating - position lights - oil pressure - parking brake - turn signal

0002.0274

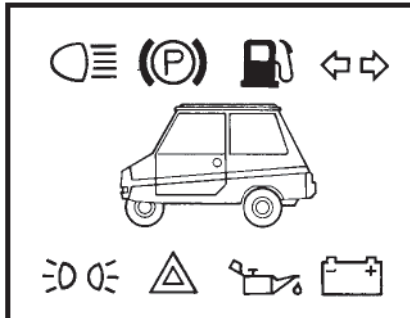

abbaglianti - freno di stazionamento - riserva carburante - indicatore direzione - luci di posizione - emergenza - pressione olio - generatore
high beams - parking brake - fuel reserve - turn signal - position lights - hazard - oil pressure - generator

0002.0275

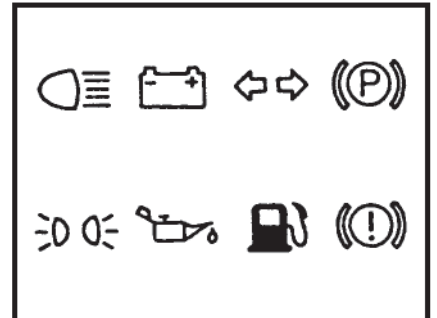

abbaglianti - generatore - indicatore direzione - freno di stazionamento - luci di posizione - pressione olio - riserva carburante - avaria freni
high beams - generator - turn signal - parking brake - position lights - oil pressure - fuel reserve - brakes failure

0002.0288

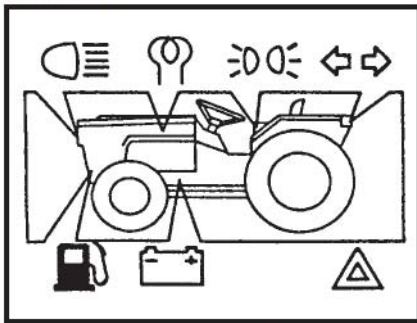

abbaglianti - preriscaldamento - luci posizione - frecce - riserva - generatore - luci emergenza
high beams - preheating - position lights - turn signal - fuel reserve - generator - hazard

0002.0312

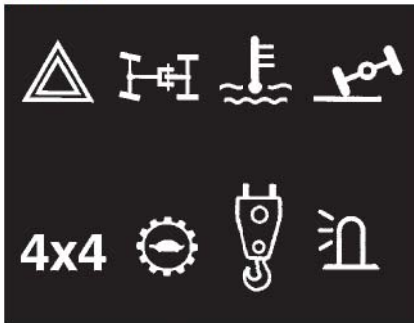

luci emergenza - trazione posteriore - temperatura acqua - inclinazione motrice - 4x4 - marce lente - gancio - faro rotante
hazard - rear drive on - water temperature - tractor's inclination - 4x4 - slow gear - hook - beacon

0002.0314

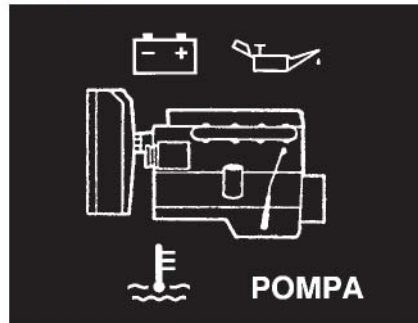

generatore - pressione olio - temperatura acqua
generator - oil pressure - water temperature

0002.0348

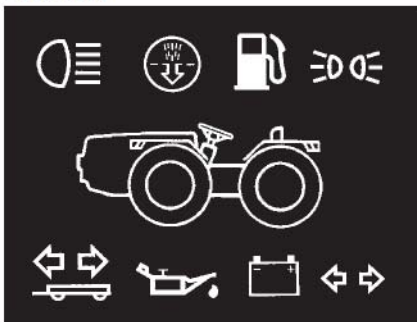

abbaglianti - filtro aria - riserva carburante - luci di posizione - direzione rimorchio - pressione olio - generatore - indicatori direzione
high beams - air filter - fuel reserve - position lights - trailer's turn signals - oil pressure - generator - turn signal

0002.0349

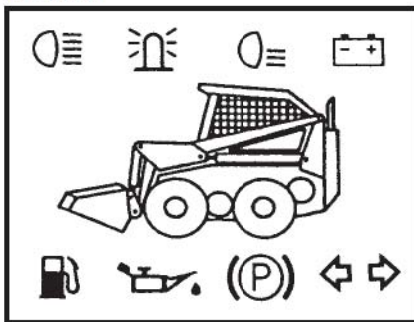

abbaglianti - faro rotante - anabbaglianti - generatore - riserva carburante - pressione olio - freno a mano - indicatori direzione
high beams - beacon - low beams - generator - fuel reserve - oil pressure - handbrake - turn signal

0002.0412

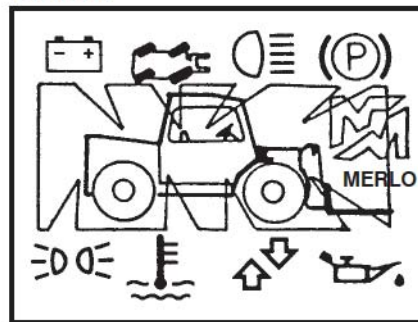

generatore - abbaglianti - freno a mano - luci di posizione - temperatura acqua - indicatori direzione - pressione olio
battery - high beams - handbrake - position lights - water temperature - turn signal - oil pressure

0002.0418

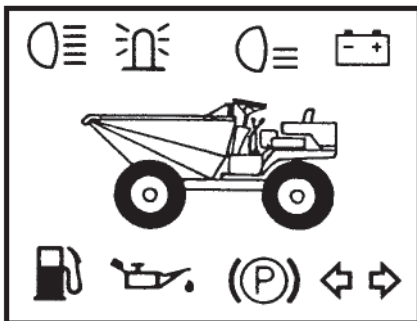

abbaglianti - faro rotante - anabbaglianti - generatore - riserva carburante - pressione olio - freno a mano - indicatori direzione
high beams - beacon - low beams - generator - fuel reserve - oil pressure - handbrake - turn signal

0002.0442

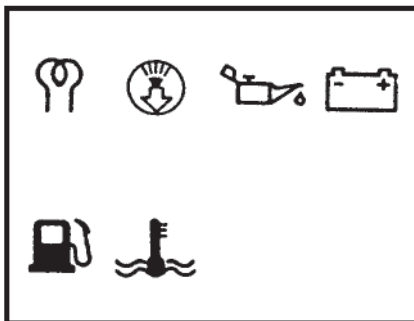

preriscaldamento - filtro aria - pressione olio - generatore - riserva carburante - temperatura acqua
preheating - air cleaner - oil pressure - generator - fuel reserve - water temperature

0002.0459

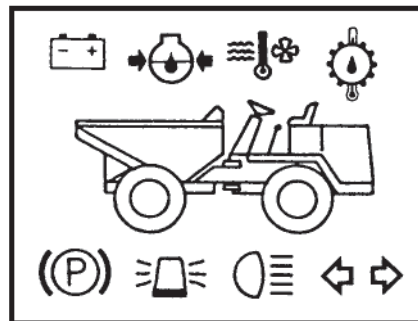

generatore - pressione olio motore - temperatura liquido di raffreddamento - pressione olio idraulico - freno stazionamento - lampada rotante - abbaglianti - indicatore direzione
battery - engine oil pressure - cooling liquid temp. - hydraulic oil pressure - parking brake - rotating beacon - high beams - turn signal

0002.0465

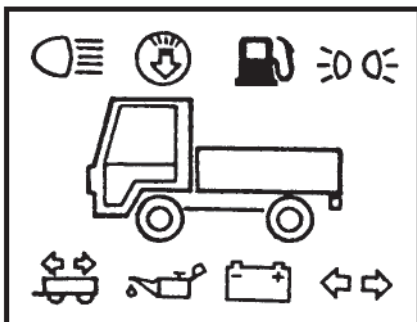

abbaglianti - filtro aria - riserva carburante - luci di posizione - direzione rimorchio - pressione olio - generatore - frecce
high beams - air cleaner - fuel reserve - position lights - trailer turn signal - oil pressure - generator - turn signal

0002.0479

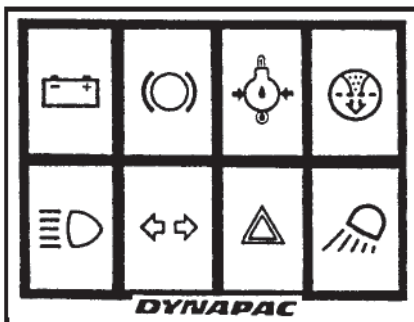

generatore - freno di stazionamento - pressione olio motore - filtro aria intasato - abbaglianti - indicatore direzione - luci emergenza - faro da lavoro
generator - parking brake - engine oil pressure - clogged air cleaner - high beams - turn signal - hazard - work lamp

0002.0489

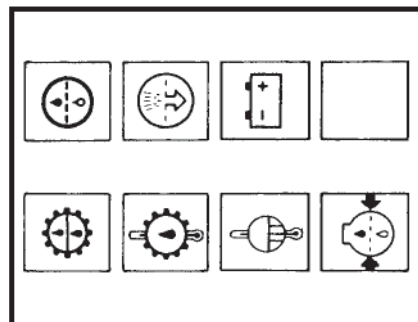

filtro olio meccanico - temperatura olio motore - temperatura acqua motore - pressione olio motore - filtro olio idraulico - filtro aria - generatore - neutro
transmission oil filter - transmission oil temperature - engine water temperature - engine oil pressure - hydraulic oil filter - air cleaner - generator - neutral

0002.0490

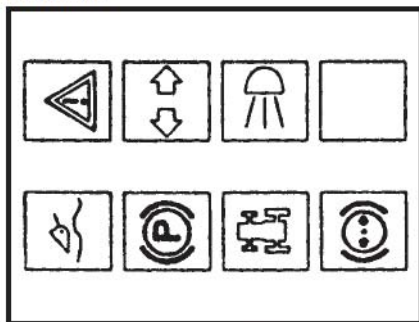

avaria - indicatori di direzione - abbaglianti - neutro -
 benna flottante - freno a mano - trazione integrale -
 pressione freni
*failure - turn signal - high beams - neutral - float bucket -
 handbrake - 4WD - brake pressure warning*

0002.0496



inclinazione veicolo
vehicle inclination

0002.0498

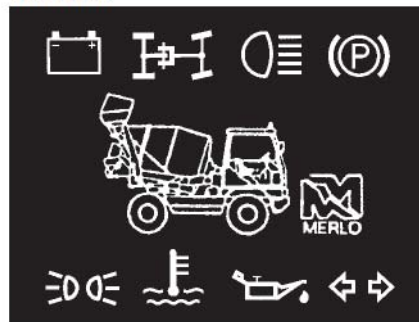

generatore - trazione anteriore - abbaglianti -
 freno stazionamento - luci di posizione -
 temperatura acqua - pressione olio - indicatore direzione
*generator - front drive on - high beams - parking brake -
 position lights - water temperature - oil pressure -
 turn signal*

0002.0522

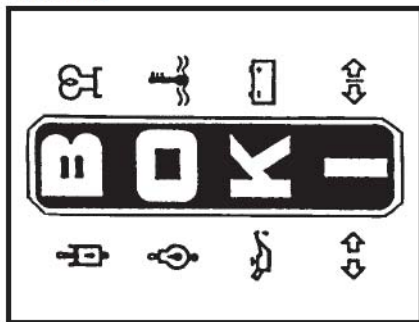

preriscaldamento - temperatura acqua - generatore -
 indicatore direzione - livello olio motore -
 pressione olio - indicatore direzione
*preheating - water temperature - generator -
 turn signal - engine oil level - oil pressure - turn signal*

0002.0526

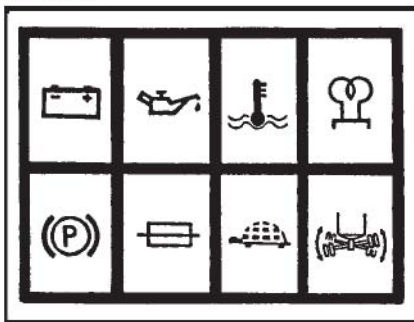

generatore - pressione olio - temperatura acqua -
 preriscaldamento - freno di stazionamento - marcia lenta
*generator - oil pressure - water temperature -
 preheating - parking brake - slow gear*

0002.0527

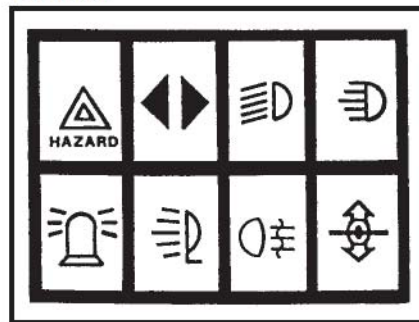

luci emergenza - indicatore direzione - anabbaglianti -
 abbaglianti - faro rotante - faro da lavoro - retronebbia
*hazard - turn signal - low beams - high beams - beacon -
 work lamp - rear fog light*

09.0991.0000



temperatura olio idraulico - riserva combustibile -
 preriscaldamento motore - freno a mano inserito -
 generatore - temperatura olio motore - filtro aria intasato -
 pressione olio motore
*hydraulic oil temperature - fuel reserve - engine preheating -
 handbrake on - generator - engine oil temperature -
 clogged air cleaner - engine oil pressure*

• **Segnalatori luminosi multipli 128x83 mm.**

Grado di protezione: IP43
Tensione di alimentazione: 12 o 24V
Materiale lente: Metacrilato
Materiale corpo: Poliammide



• **Multiple warning lights 128x83 mm.**

Sealing: IP43
Power supply voltage: 12 or 24V
Lens material: Methacrylate
Housing material: Polyamide

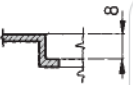
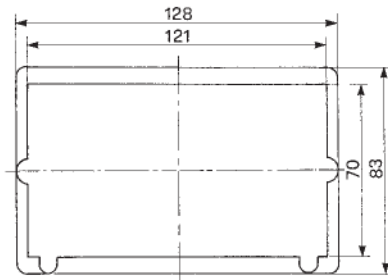
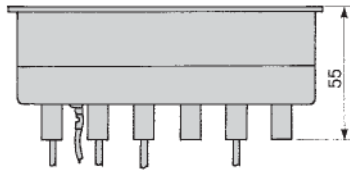
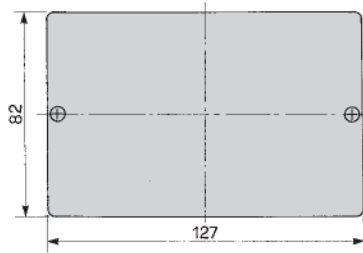

W3W
12V-3W
24V-3W

09.057.000

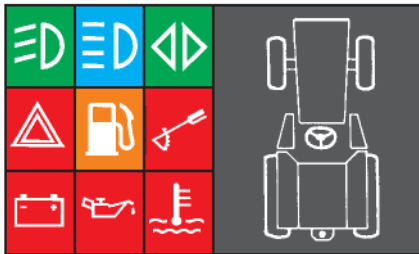

luci anabbaglianti - luci abbaglianti - indicatore di direzione - emergenza -
riserva carburante - freno a mano inserito - generatore -
pressione olio motore - massima temperatura acqua
low beams - high beams - turn signal - hazard - fuel reserve -
hand brake on - generator - engine oil pressure - water max. temperature

09.060.000

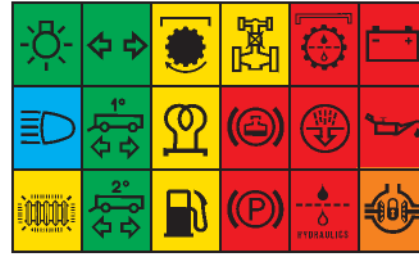

illuminazione generale - indicatore di direzione - presa movimento - 4 ruote motrici -
filtri olio trasmissione - generatore - luci abbaglianti - indicatore di direzione 1° rimorchio -
pre-riscaldamento motore - basso livello liquido freni - filtro aria - pressione olio motore -
riscaldamento interno indicatore di direzione 2° rimorchio - riserva carburante -
freno a mano inserito - filtro olio idraulico - differenziale bloccato
general lighting - turn signal - power take-off - 4 wheel drive - transmission oil filter -
generator - high beams - 1st trailer's turn signal - engine preheating - low brake fluid level -
air cleaner - engine oil pressure - inside heating - 2nd trailer's turn signal - fuel reserve -
hand brake on - hydraulic oil filter - differential lock

09.066.000

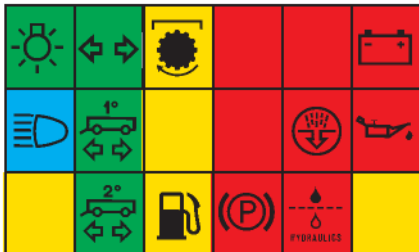

illuminazione generale - indicatore di direzione motrice - presa di forza - neutro - neutro -
generatore - luci abbaglianti - indicatore di direzione 1° rimorchio - neutro - neutro -
filtro aria - pressione olio motore - neutro - indicatore di direzione 2° rimorchio -
riserva carburante - freno a mano inserito - filtro olio idraulico - neutro
general lighting - turn signal - power take-off - neutral - neutral - generator - high beams -
1st trailer's turn signal - neutral - neutral - air cleaner - engine oil pressure - neutral -
2nd trailer's turn signal - fuel reserve - hand brake on - hydraulic oil filter - neutral

09.070.000



generatore - temperatura acqua - pressione olio motore - filtro aria - riserva carburante -
emergenza - luci di posizione - luci abbaglianti - direzione motrice - direzione rimorchio -
controllo coclea granella - controllo coclea recupero - ingolfamento scuotipaglia -
temperatura olio circuito trinciapaglia - serbatoio grano pieno -
pressione olio serbatoio idrostatica - pressione olio pompa idrostatica -
filtro olio circuito idrostatico
generator - water temperature - engine oil pressure - air cleaner - fuel reserve - hazard -
position lights - high beams - tractor's turn signals - trailer's turn signals -
wheat auger control - recovery auger control - hay shaker obstruction - straw chopper circuit
oil temperature - full corn tank - hydrostatic tank oil pressure - hydrostatic pump oil pressure -
hydrostatic circuit oil filter

09.073.000



luci anabbaglianti - luci abbaglianti - indicatore di direzione - riserva carburante - trazione anteriore - generatore - pressione olio motore - emergenza - temperatura acqua - trazione anteriore inserita - trazione anteriore disinserita - trazione posteriore - low beams - high beams - turn signal - fuel reserve - front drive - generator - engine oil pressure - hazard - water temperature - front drive on - front drive off - rear drive

09.074.000

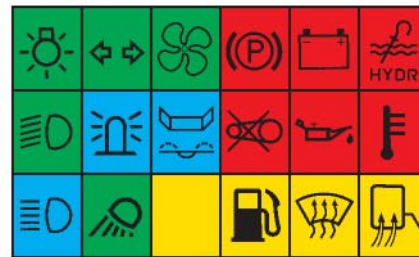

illuminazione generale - indicatore di direzione - elettroventilatore - freno a mano inserito - generatore - livello olio idraulico - luci anabbaglianti - lampada rotante - lama automatica - rottura cinghia - pressione olio motore - alta temperatura - luci abbaglianti - proiettore lavoro - riserva carburante - riscaldamento parabrezza - retrovisori riscaldati - master switch - turn signal - electric fan - hand brake on - generator - hydraulic oil level - low beams - beacon - automatic knife - belt breaking - engine oil pressure - high temperature - high beams - work lamp - fuel reserve - windscreen heating - heated side mirrors

09.075.000



luci anabbaglianti - retronebbia - livello liquido - freno a mano inserito - emergenza - cintura di sicurezza - luci esterne - fendinebbia - riserva carburante - bassa pressione olio motore - filtro aria - warning 2wd low - indicatore di direzione - luci abbaglianti - water trap - generatore - avaria freni - bloccaggio differenziale - low beams - rear fog light - liquid level - fuel reserve - engine oil pressure - air cleaner - warning 2wd low - turn signal - high beams - water trap - generator - brake failure - differential lock

09.079.000



serbatoio grano pieno - coclea - allarme sovraccarico cassa - rullo lanciatore - pressione olio motore - temperatura acqua - filtro aria motore - pressione olio serbatoio idrostatico - livello olio serbatoio idrostatico - temperatura olio serbatoio idrostatico - filtro olio serbatoio idrostatico - riserva carburante - generatore - freno a mano inserito - luci di posizione - luci abbaglianti - indicatore direzione motrice - indicazione direzione rimorchio - emergenza - full corn tank - auger - overload alarm of tower roller box - engine oil pressure - water temperature - engine air cleaner - hydrostatic tank oil pressure - hydrostatic tank oil level - hydrostatic tank oil filter - fuel reserve - generator - hand brake on - position lights - high beams - tractor's turn signals - trailer's turn signals - hazard

09.080.000

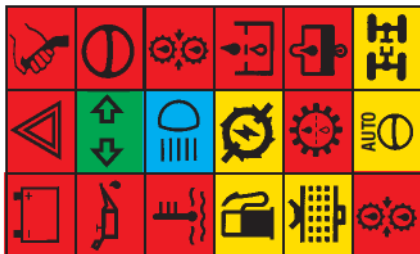

freno a mano - ingrassaggio trasmissione - filtro olio idraulico - pompa idraulica - riduttore - emergenza - indicatore direzione - abbaglianti - alternatore - differenziale bloccato - generatore - pressione olio motore - temperatura liquido raffreddamento - riserva carburante - filtro aria pieno - ingrassaggio trasmissione - handbrake - transmission greasing - hydraulic oil filter - hydraulic pump - adapter - hazard - differential lock - low beams - high beams - water trap - generator - brake failure - differential lock

09.081.000



generatore - bassa pressione olio motore - temperatura liquido raffreddamento - riserva carburante - fuori giri - marcia avanti - luci anabbaglianti - luci abbaglianti - lampada rotante - freno a mano inserito - 4 ruote motrici marcia neutra - indicatore di direzione - primo rimorchio - secondo rimorchio - marcia indietro - generator - low engine oil pressure - cooling liquid temperature - fuel reserve - over rpm - forward - low beam - high beam - rotating beacon - hand brake on - 4WD neutral - turn signal - first trailer - second trailer - reverse

09.139.000

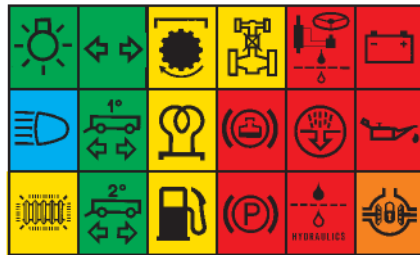

illuminazione generale - indicatore di direzione - presa movimento - 4 ruote motrici - idroguida - generatore - luci abbaglianti - indicatore di direzione 1° rimorchio - preriscaldamento motore - basso livello liquido freni - filtro aria - pressione olio motore - riscaldamento interno - indicatore di direzione 2° rimorchio - riserva carburante - freno a mano inserito - filtro olio idraulico - differenziale bloccato - master switch - turn signal - power take-off - 4 wheel drive - hydroguide - generator - high beams - 1st trailer turn signal - engine preheating - brake fluid low level - air cleaner - engine oil pressure - inside heating - 2nd trailer turn signal - fuel reserve - hand brake on - hydraulic oil filter - differential lock

09.0314.0000



generatore - preriscaldamento - riserva carburante - illuminazione generale - freno a mano inserito - lampada rotante - allarme - temperatura acqua - temperatura olio trasm. - pressione olio motore - filtro aria intasato - livello olio idraulico - blocco joystick - benna - sbrinatori - valvola pompa idraulica - ripiegamento braccio escavatore - pressione olio idraulico - generator - preheating - fuel reserve - master switch - hand brake on - rotating beacon - hazard - water temperature - transmission oil temperature - engine oil pressure - clogged air cleaner - hydraulic oil level - joystick locking - bucket - defroster - hydraulic pump valve - boom locking - hydraulic oil pressure

09.0315.0000



Indicatore LH - luci abbaglianti - illuminazione generale - freno a mano inserito - controllo stabilità - indicatore RH - allarme - differenziale bloccato - riserva carburante - temperatura olio idraulico - olio trasmissione - temperatura acqua - 4 ruote motrici - trazione anteriore - trazione posteriore - sterzata

LH indicator - high beam - master switch - hand brake on - ride control - RH indicator - hazard - differential lock - fuel reserve - hydraulic oil temperature - water temperature - 4WD - front drive - rear drive - crab steering

09.0319.0000



generatore - preriscaldamento - riserva carburante - temperatura olio - freno a mano inserito - lampada rotante - allarme - temperatura acqua - controllo stabilità - pressione olio motore - filtro aria intasato - riserva carburante - blocco joystick - benna - sbrinatori - valvola pompa idraulica - ripiegamento braccio escavatore - optional

generator - preheating - fuel reserve - oil temperature - hand brake on - rotating beacon - hazard - water temperature - ride control - engine oil pressure - clogged air cleaner - fuel reserve - joystick locking - bucket - defroster - hydraulic pump valve - boom locking - optional

09.0320.0000

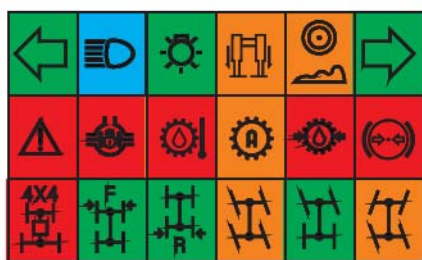

Indicatore LH - luci abbaglianti - illuminazione generale - stabilizzatore - controllo stabilità - indicatore RH - allarme - differenziale bloccato - temperatura olio trasmissione - stato trasmissione - pressione olio trasmissione - pressione impianto frenante - 4 ruote motrici - trazione anteriore - trazione posteriore - sterzata

LH indicator - high beam - master switch - hand brake on - ride control - RH indicator - hazard - differential lock - transmission oil temperature - transmission status - transmission oil pressure - brake system pressure - 4WD - front drive - rear drive - crab steering

• **Segnalatori luminosi multipli 127x61 mm.**

Grado di protezione: IP54
Tensione di alimentazione: 12 o 24V
Materiale lente: Metacrilato
Materiale corpo: ABS

• **Multiple warning lights 127x61 mm.**

Sealing: IP54
Power supply voltage: 12 or 24V
Lens material: Methacrylate
Housing material: ABS

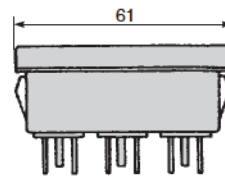
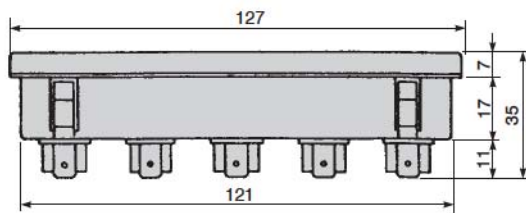

W3W
12V-3W
24V-3W

0002.0420

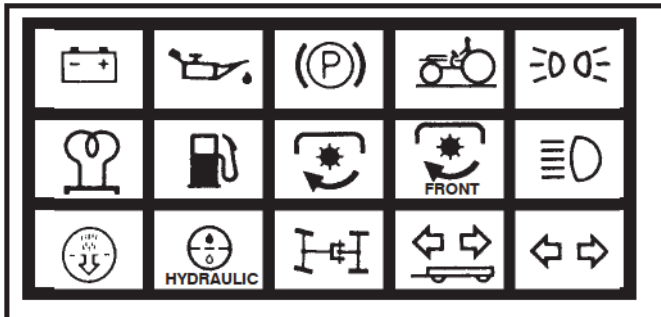

generatore - preriscaldamento - filtro aria intasato - pressione olio - riserva carburante - filtro olio idraulico - freno di stazionamento - presa movimento - trazione integrale - roll-bar - presa movimento front - direzione rimorchio - luci di posizione - abbaglianti - indicatore di direzione
generator - preheating - clogged air cleaner - oil pressure - fuel reserve - hydraulic oil filter - parking brake - power take-off - 4WD - roll-bar - front power take-off - trailer turn signal - position lights - high beams - turn signal

0002.0520



generatore - indicatore direzione - abbaglianti - filtro olio - ventilazione - pressione olio - marce lente - riserva carburante - anabbaglianti - retromarcia - temperatura acqua - marce veloci - freno di stazionamento - luci posizione - filtro aria intasato
generator - turn signal - high beams - oil filter - fan - oil pressure - slow gear - fuel reserve - low beams - reverse lamp - water temperature - fast gear - parking brake - position lights - clogged air cleaner

• **Segnalatori luminosi multipli 127x82 mm.**

Grado di protezione: IP54
Tensione di alimentazione: 12 o 24V
Materiale lente: Metacrilato
Materiale corpo: Poliammide

• **Multiple warning lights 127x82 mm.**

Sealing: IP54
Power supply voltage: 12 or 24V
Lens material: Methacrylate
Housing material: Polyamide

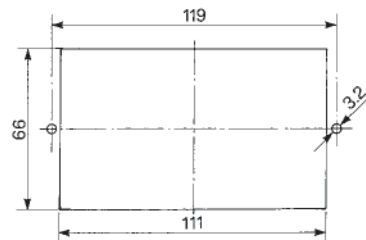
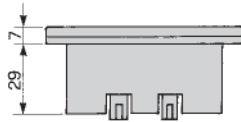
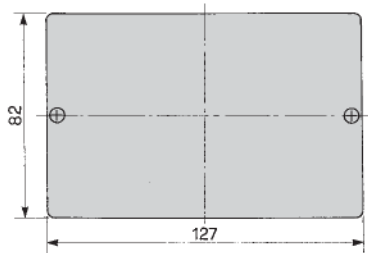

W3W
12V-3W
24V-3W

09.142.000

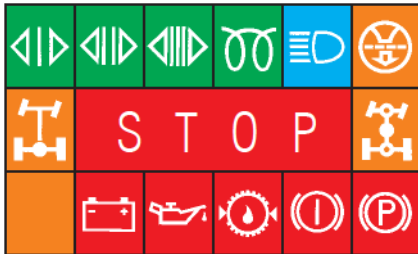

indicatore di direzione - indicatore di direzione 1° rimorchio - indicatore di direzione - 2° rimorchio - preriscaldamento - luci abbaglianti - filtro aria - bloccaggio differenziale posteriore - stop intermittente 90 ± 30 - 4 ruote motrici - generatore - pressione olio motore - pressione olio trasmissione - serbatoio liquido freni - freno a mano inserito
turn signal - 1st trailer's turn signal - 2nd trailer's turn signal - preheating - high beams - air cleaner - rear differential lock - flashing stop 90 ± 30 - 4 wheel drive - generator - engine oil pressure - transmission oil pressure - brake fluid tank - hand brake on

09.143.000

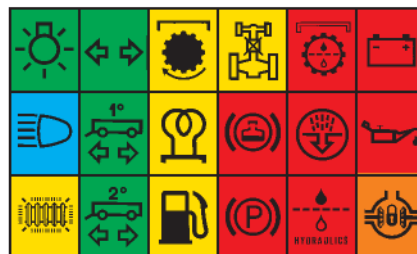

illuminazione generale - indicatore di direzione - presa movimento - 4 ruote motrici - filtro olio trasmissione - generatore - luci abbaglianti - indicatore di direzione 1° rimorchio - preriscaldamento motore - basso livello - liquido freni - filtro aria - pressione olio motore - riscaldamento interno - indicatore di direzione 2° rimorchio - riserva carburante - freno a mano inserito - filtro olio idraulico - differenziale bloccato
master switch - turn signal - power take-off - 4 wheel drive - transmission oil filter - generator - high beams - 1st trailer's turn signal - engine preheating - low brake fluid level - air cleaner - engine oil pressure - inside heating - 2nd trailer's turn signal - fuel reserve - hand brake on - hydraulic oil filter - differential lock

09.146.000



freno a mano inserito - luci abbaglianti - emergenza - pressione olio motore - retronebbia - marce lente - luci di posizione - riserva carburante - generatore - lunotto termico - 4 ruote motrici - indicatore direzione - preriscaldamento motore - massima temperatura acqua
hand brake on - high beams - hazard - engine oil pressure - rear fog light - slow gears - position lights - fuel reserve - generator - heated rear window - 4 wheel drive - turn signal - engine preheating - max water temperature

09.147.000



luci anabbaglianti - retronebbia - riscaldamento parabrezza - freno a mano inserito - emergenza - cintura di sicurezza - luci esterne - fendinebbia - riserva carburante - bassa pressione olio motore - filtro aria - warning 2wd low - indicatore di direzione - luci abbaglianti - catalyst - generatore - avaria freni - bloccaggio differenziale
low beams - rear fog light - windscreen heating - hand brake on - hazard - safety belt - external lamps - fog lamp - fuel reserve - engine oil pressure - air cleaner - warning 2wd low - turn signal - high beams - catalyst - generator - brake failure - differential lock

09.148.000

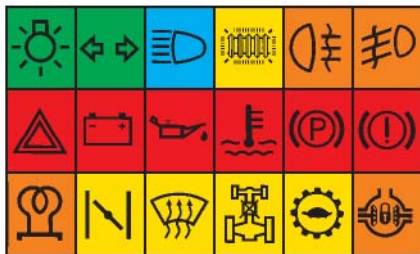

illuminazione generale - indicatore di direzione - luci abbaglianti - riscaldamento interno - retroniebbia - fendinebbia - emergenza - generatore - pressione olio motore - massima temperatura acqua - freno a mano inserito - avaria freni - preriscaldamento - starter - riscaldamento parabrezza - 4 ruote motrici - marce lente - differenziale bloccato - master switch - turn signal - high beams - inside heating - rear fog light - fog lamp - hazard - generator - engine oil pressure - max water temperature - hand brake on - brake failure - engine preheating - starter - windscreen heating - 4 wheel drive - slow gears - differential lock

09.158.000



anabbagliante - indicatori direzioni - alza lama rotante - filtro aria intasato - emergenza - trazione integrale - bloccaggio differenziale - generatore - stop - preriscaldamento - riserva carburante - pressione olio motore - temperatura acqua - temperatura olio idraulico - freno di stazionamento
 low beam - turn signal - blade control - clogged air cleaner - hazard - four wheel drive - differential lock - generator - stop - preheating - fuel reserve - engine oil pressure - water temperature - hydraulic oil temperature - hand brake

09.174.000

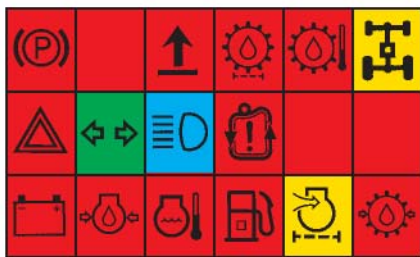

freno a mano inserito - neutro - movimento verticale - filtro olio trasmissione - temperatura olio trasmissione - 4 ruote motrici - emergenza - indicatore di direzione - luci abbaglianti - * - neutro - neutro - generatore - pressione olio motore - temperatura olio motore - combustibile - filtro aria intasato - pressione olio trasmissione - 4 wheel drive - hazard - turn signal - high beams - * - neutral - neutral - generator - engine oil pressure - engine oil temperature - fuel reserve - clogged air cleaner - transmission oil pressure

* indica funzione specifica - it shows a specific function

09.181.000

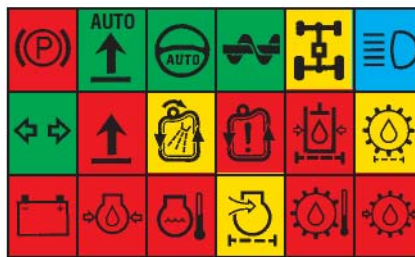

freno a mano inserito - movimento verticale alto - pilota automatico - coclea - 4 ruote motrici - luci abbaglianti - indicatori di direzione - movimento verticale - * - * - filtro olio idraulico - filtro olio trasmissione - generatore - pressione olio lubrificante motore - temperatura olio motore - filtro aria intasato - temperatura olio trasmissione - pressione olio trasmissione
 hand brake - high vertical movement - automatic pilot - auger - 4 wheel drive - high beams - turn signal - vertical movement - * - * - hydraulic oil filter - transmission oil filter - generator - engine oil pressure - engine oil temperature - clogged air cleaner - transmission oil temperature - transmission oil pressure

* indica funzione specifica - it shows a specific function

• **Segnalatori luminosi multipli 130x126 mm.**

Grado di protezione: IP54
Tensione di alimentazione: 12 o 24V

• **Multiple warning lights 130x126 mm.**

Sealing: IP54
Power supply voltage: 12 or 24V

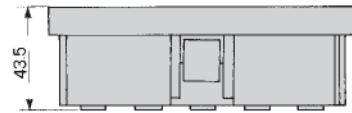
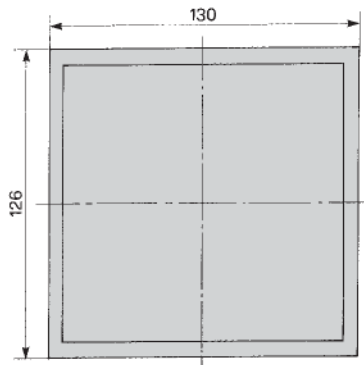

W3W
12V-3W
24V-3W

09.159.000

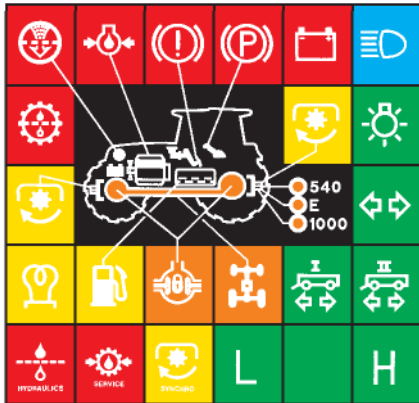

filtro aria intasato - pressione olio motore - avaria freni - freno di stazionamento - generatore - abbaglianti - filtro olio cambio - presa di forza posteriore - luci di posizione - presa di forza anteriore - indicatore di direzione - preriscaldamento - riserva carburante - differenziale bloccato - trazione integrale - direzione 1° rimorchio - direzione 2° rimorchio - filtro olio idraulico - service - presa di forza anteriore - low - high
clogged air cleaner - engine oil pressure - brakes average - parking brake - generator - high beams - transmission oil filter - rear p.t.o. - position light - front p.t.o. - turn signal - preheating - fuel reserve - differential lock - drive on - 1st trailer's turn signal - 2nd trailer's turn signal - hydraulic oil filter - service - front power take-off - low - high

09.168.000

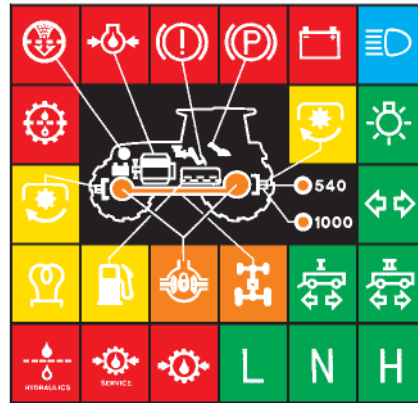

filtro aria intasato - pressione olio motore - avaria freni - freno di stazionamento - generatore - abbaglianti - filtro olio cambio - presa di forza posteriore - luci di posizione - presa di forza anteriore - indicatore di direzione - preriscaldamento - riserva carburante - differenziale bloccato - trazione integrale - direzione 1° rimorchio - direzione 2° rimorchio - filtro olio idraulico - service - bassa pressione olio trasmissione - low - neutral - high
clogged air cleaner - engine oil pressure - brakes average - parking brake - generator - high beams - transmission oil filter - rear p.t.o. - position light - front p.t.o. - turn signal - preheating - fuel reserve - differential lock - drive on - 1st trailer's turn signal - 2nd trailer's turn signal - hydraulic oil filter - service - low transmission oil pressure - low - neutral - high

09.171.000



filtro aria intasato - pressione olio motore - avaria freni - freno di stazionamento - generatore - abbaglianti - filtro olio cambio - presa di forza posteriore - luci di posizione - presa di forza anteriore - indicatore di direzione - preriscaldamento - riserva carburante - differenziale bloccato - trazione integrale - direzione 1° rimorchio - direzione 2° rimorchio - filtro olio idraulico - service - freno rimorchio - bassa velocità - media velocità - alta velocità
clogged air cleaner - engine oil pressure - brakes average - parking brake - generator - high beams - transmission oil filter - rear p.t.o. - position light - front p.t.o. - turn signal - preheating - fuel reserve - differential lock - drive on - 1st trailer's turn signal - 2nd trailer's turn signal - hydraulic oil filter - service - trailer brake - slow gear - medium gear - fast gear

09.172.000

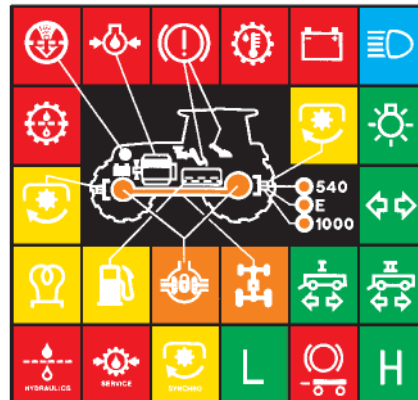

filtro aria intasato - pressione olio motore - avaria freni - freno di stazionamento - generatore - abbaglianti - filtro olio cambio - presa di forza posteriore - luci di posizione - presa di forza anteriore - indicatore di direzione - preriscaldamento - riserva carburante - differenziale bloccato - trazione integrale - direzione 1° rimorchio - direzione 2° rimorchio - filtro olio idraulico - service - presa di forza anteriore - low - freno rimorchio - high
clogged air cleaner - engine oil pressure - brakes average - parking brake - generator - high beams - transmission oil filter - rear p.t.o. - position light - front p.t.o. - turn signal - preheating - fuel reserve - differential lock - drive on - 1st trailer's turn signal - 2nd trailer's turn signal - hydraulic oil filter - service - front power take-off - low - trailer brake - high

09.173.000

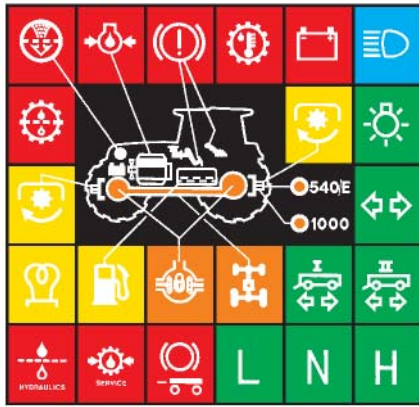

filtro aria intasato - pressione olio motore - avaria freni - temperatura olio trasmissione - generatore - abbaglianti - filtro olio cambio - presa di forza posteriore - luci di posizione - presa di forza anteriore - indicatore di direzione - preriscaldamento - riserva carburante - differenziale bloccato - trazione integrale - direzione 1° rimorchio - direzione 2° rimorchio - filtro olio idraulico - service - freno rimorchio - low - neutral - high
clogged air cleaner - engine oil pressure - brakes average - transmission oil temperature - generator - high beams - transmission oil filter - rear p.t.o. - position light - front p.t.o. - turn signal - preheating - fuel reserve - differential lock - drive on - 1st trailer's turn signal - 2nd trailer's turn signal - hydraulic oil filter - service - trailer brake - low - neutral - high

09.187.000

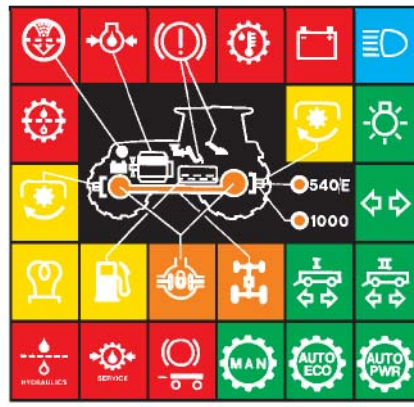

filtro aria intasato - pressione olio motore - avaria freni - temperatura olio trasmissione - generatore - abbaglianti - filtro olio cambio - presa di forza posteriore - luci di posizione - presa di forza anteriore - indicatore di direzione - preriscaldamento - riserva carburante - differenziale bloccato - trazione integrale - direzione 1° rimorchio - direzione 2° rimorchio - filtro olio idraulico - service - freno rimorchio - man - auto eco - auto pwr
clogged air cleaner - engine oil pressure - brakes average - transmission oil temperature - generator - high beam - transmission oil filter - rear p.t.o. - position light - front p.t.o. - turn signal - preheating - fuel reserve - differential lock - drive on - 1st trailer's turn signal - 2nd trailer's turn signal - hydraulic oil filter - service - trailer brake - man - auto eco - auto pwr

09.194.000



filtro aria intasato - pressione olio motore - avaria freni - temperatura olio trasmissione - generatore - abbaglianti - filtro olio cambio - presa di forza posteriore - luci di posizione - presa di forza anteriore - indicatore di direzione - preriscaldamento - riserva carburante - differenziale bloccato - trazione integrale - direzione 1° rimorchio - direzione 2° rimorchio - filtro olio idraulico - service - presa di forza anteriore - bassa velocità - media velocità - alta velocità
clogged air cleaner - engine oil pressure - brakes average - transmission oil temperature - generator - high beam - transmission oil filter - rear p.t.o. - position light - front p.t.o. - turn signal - preheating - fuel reserve - differential lock - drive on - 1st trailer's turn signal - 2nd trailer's turn signal - hydraulic oil filter - service - front power take-off - slow gear - medium gear - fast gear

• **Segnalatori luminosi 71x30,8 mm.**

Grado di protezione: IP5X
 Tensione di alimentazione: 12V
 Temperatura di funzionamento: -40°C÷+70°C
 Materiale lente: Policarbonato
 Materiale corpo: ABS



• **Warning lights 71x30,8 mm.**

Sealing: IP5X
 Power supply voltage: 12V
 Operating temperature: -40°C ÷ +70°C
 Lens material: Polycarbonate
 Housing material: ABS

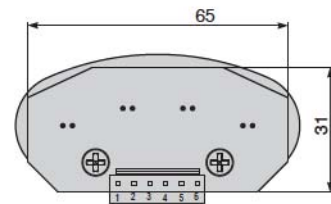
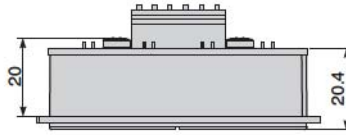
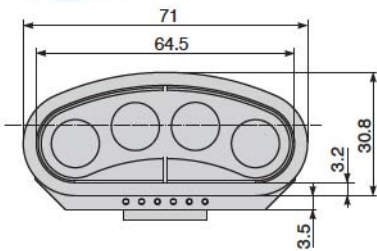

09.1000.0000

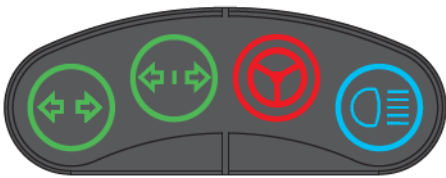

indicatore di direzione - indicatore di direzione - volante - luci di profondità
 turn signal - turn signal - steering wheel - high beams

09.1003.0000

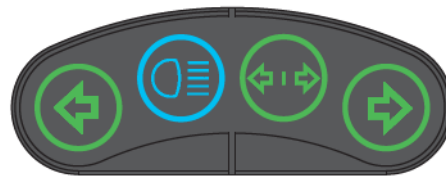

indicatore - luci di profondità - indicatore di direzione - indicatore
 indicator - high beams - turn signal - indicator

09.1004.0000

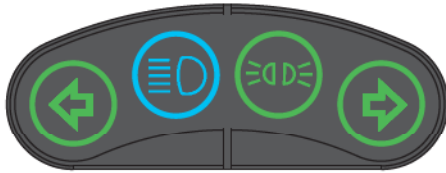

indicatore - luci di profondità - luci di posizione - indicatore
 indicator - high beams - parking lights - indicator

09.1019.0000

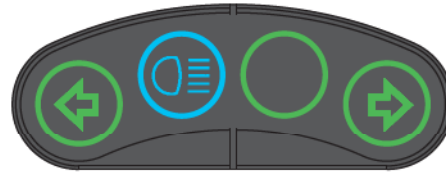

indicatore - luci di profondità - neutro - indicatore
 indicator - high beams - neutral - indicator

09.1037.0000

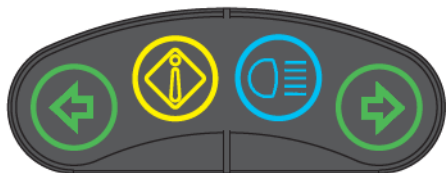

indicatore - avviso - luci di profondità - indicatore
 indicator - warning - high beams - indicator

09.1044.0000

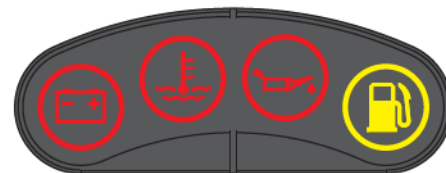

carica generatore - massima temperatura acqua - bassa pressione olio motore - riserva carburante
 generator load - max water temperature - low engine oil pressure - fuel reserve

- **Segnalatori luminosi 192x49,5 mm.**

Grado di protezione: IPXX
 Tensione di alimentazione: 24V
 Temperatura di funzionamento: -40°C÷+60°C
 Materiale corpo: ABS

- **Warning lights 192x49,5 mm.**

Sealing: IPXX
 Power supply voltage: 24V
 Operating temperature: -40°C ÷ +60°C
 Housing material: ABS

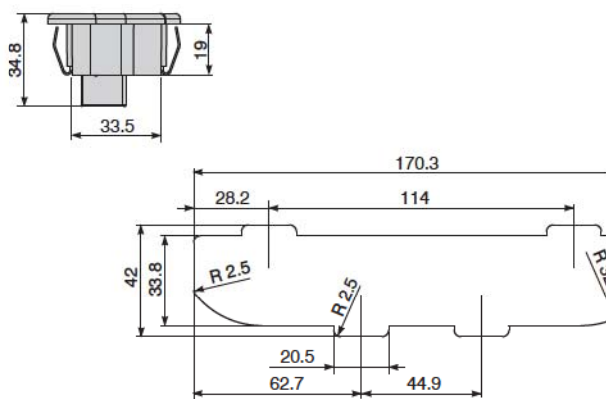
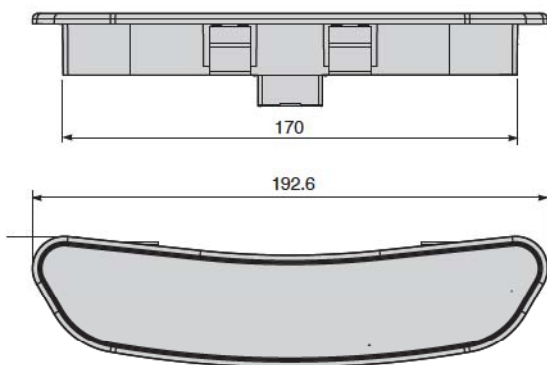

32.0362.0000



luci di profondità - luci anabbaglianti - indicatore di direzione - carica generatore - massima temperatura acqua - bassa pressione olio motore
 high beams - low beams - turn signal - generator load - max water temperature - low engine oil pressure

32.0367.0000



indicatore - luci di profondità - luci anabbaglianti - carica generatore - massima temperatura acqua - bassa pressione olio motore - indicatore
 indicator - high beams - low beams - generator load - max water temperature - low engine oil pressure - indicator