

FAHRION®
PRÄZISION
And all runs smoothly.



Tool clamping systems

Precision Collet Chucks CENTRO|P
Tapping Chucks SYNCHRO|T

Overview of Contents

Page

The Precision Modular System	4
The trademark FAHRION	6
FAHRION Protect	10
Product Range	12

Precision Collets and Tapping Chucks

Precision Collet Chucks CENTRO P	GER	GOZ
Tapping Chucks SYNCHRO T		GB

Holder	Type	Page	GER	GOZ	GB
Taper Shanks DIN 69871	AD30	18	■		
	AD40-AD/B40	19	■	■	■
	AD50-AD/B50	22	■	■	■
Hollow Tapers DIN 69893 / ISO 12164	HSK-A32	23	■		
	HSK-A40	24	■		■
	HSK-A50	27	■		■
	HSK-A63	30	■		■
	HSK-A80	34	■	■	■
	HSK-A100	35	■	■	■
Hollow Tapers DIN 69893	HSK-E25	36	■		
	HSK-E32	37	■		
	HSK-E40	38	■		
	HSK-E50	39	■		
	HSK-E63	40	■		
	HSK-F50	40	■		
	HSK-F63	41	■	■	
Polygonal Shanks ISO 26623-1	C3	42	■		
	C4	43	■		
	C5	44	■		
	C6	45	■		
	C8	46	■		
Taper Shanks JISB 6339	MAS/BT30 (AD)	47	■		
	MAS/BT40 (AD•AD/B)	49	■	■	■
	MAS/BT50 (AD•AD/B)	52	■		■
Taper Shanks JISB 6339 with Face Contact	MAS/BTP30 (AD)	53	■		
	MAS/BTP40 (AD)	55	■		
Taper Shanks ANSIB.50	CAT40 (AD/B)	57	■		
	CAT50 (AD/B)	59	■		
Cylindrical Shanks	Z (AD)	60	■		■
Taper Shanks similar to DIN 69871 (Wood working)	A30 (AD)	61	■	■	

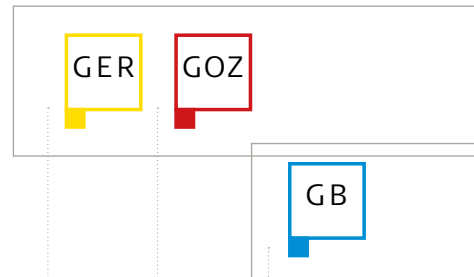

Page

Precision and Tap Collets

Precision Collets GERC-HP DIN ISO 15488-B (ER/ESX)	69	■		
Precision Collets GERC-HPD similar to DIN ISO 15488-A with Seals for IC (Inner Coolant Supply)	70	■		
Precision Collets GERC-HPDD similar to DIN ISO 15488-A with Seals for IC (Inner Coolant Supply) and Jet Holes	71	■		
Tap Collets GERC-GBD similar to DIN ISO 15488-A with Seals for IC (Inner Coolant Supply)	72	■		■
Tap Collets GERC-GBDD similar to DIN ISO 15488-A with Seals for IC (Inner Coolant Supply) and Jet Holes	73	■		■
Precision Collets GOZ DIN ISO 10897-B	74		■	

Accessories

Clamping Nuts HPC	62	■	■	
Roller Bearing Wrenches RO DRO	67	■	■	■
Torque Setting Wrenches DRMO DRTW	68	■	■	■
Mounting Devices TBRS	68	■	■	■
Sealing Discs DI DIG	75	■	■	
Data Carriers BIS	75	■	■	■
Adjustable Stop Screws AS-U AS-W	76	■	■	
Taper Wipers KWK	77	■	■	■
Coolant Supply Tubes and Wrenches IKR SCHL-IKR	78	■	■	■
Pull Studs AZB	79	■	■	■

Conversion Table	82
Ordering example	83
Balancing	84

We reserve the right to change the design and specification of any product shown within this catalogue, which does not result in the adverse function of the corresponding tools.

The FAHRION Precision Modular System

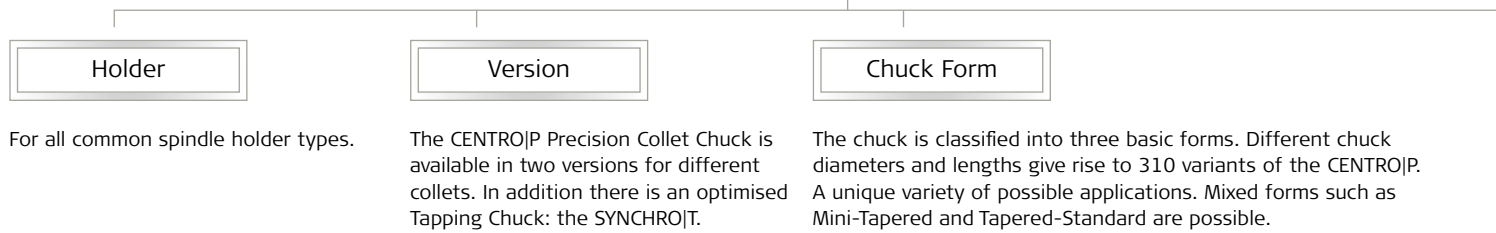
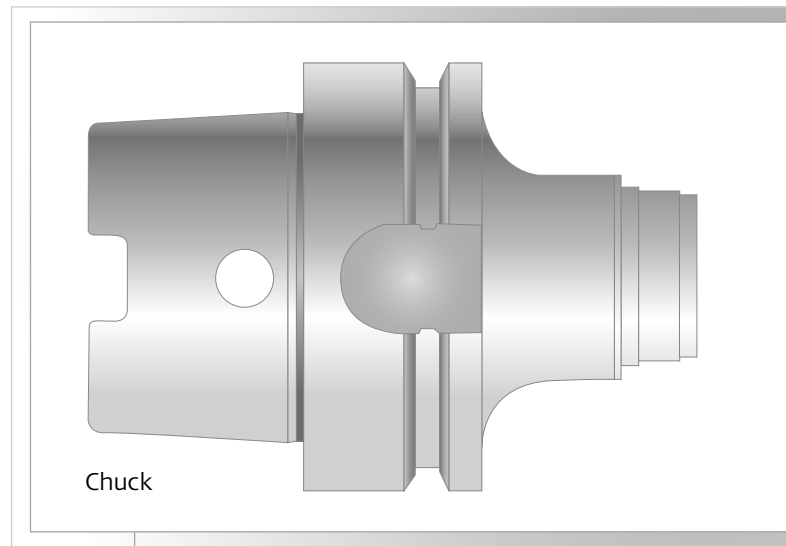

Holder

For all common spindle holder types.

Version

The CENTRO|P Precision Collet Chuck is available in two versions for different collets. In addition there is an optimised Tapping Chuck: the SYNCHRO|T.

Chuck Form

The chuck is classified into three basic forms. Different chuck diameters and lengths give rise to 310 variants of the CENTRO|P. A unique variety of possible applications. Mixed forms such as Mini-Tapered and Tapered-Standard are possible.

-  = DIN 69871
SK
30/40/50
-  = DIN 69893/ISO 12164
HSK-A
32/40/50/63/80/
100
-  = DIN 69893
HSK-E
25/32/40/50/63
-  = DIN 69893
HSK-F
50/63
-  = ISO 26623 -1
C
3 / 4 / 5 / 6 / 8
-  = JIS 6339
MAS/BT
30/40/50
MAS/BTP
30/40
-  = ANSI B5.50
CAT
40/50
-  = DIN 1835
Z
10/16/20/25/32

- GER** CENTRO|P
- for collets according to DIN ISO 15488 - B(ER/ESX) and FAHRION tap collets similar to DIN ISO 15488-A
 - very high concentricity of $\leq 3 \mu\text{m}$ with FAHRION collets GERC-HP/HPD/HPDD

- GOZ** CENTRO|P
- for collets according to DIN ISO 10897 - B(OZ)
 - extremely stable versions with holding forces of over 600Nm with CP432
 - ideal for rough milling

- GB** SYNCHRO|T
- for Tap collets similar to DIN ISO 15488 - A with internal square drive
 - with minimum length compensation

- MINI**
- slim version for HPCM Mini Clamping Nuts
 - small interference contour
 - External diameter of clamping nuts 10/16/22mm
 - Clamping ranges 1 – 5 mm (GERC8), 1 – 7 mm (GERC11), 1 – 10 mm (GERC16)
 - Standard projection lengths (dimension A) of 50/70/75/90/100/120/4"/130/6"/150/160mm (type-dependent)
- Application examples: HSC machining, die and mould making, medical and dental technology, drilling/reaming/finishing

- TAPERED**
- tapered version for HPC Special Clamping Nuts
 - small interference contour with External diameter of clamping nuts 16/22/24mm
 - Clamping ranges 1 – 7 mm (GERC11), 1 – 10 mm (GERC16)
 - Standard projection lengths (dimension A) of 45/55/60/100/4"/130/6"/160mm (type-dependent)
- Application examples: HSC machining, model, mould and tool making, drilling/reaming/finishing and roughing

- STANDARD**
- rigid version for HPC Standard Clamping Nuts
 - External diameter of clamping nuts 30/32/40/50/63mm
 - Clamping ranges 1 – 10 mm (GERC16), 1 – 13 mm (GERC20), 1 – 16 mm (GERC25), 2 – 20 mm (GERC32), 3 – 26 mm (GERC40), 2 – 25 mm (FM25DG), 4 – 32 mm (FM32DG)
 - standard projection lengths (dimension A) of 40/48/50/60/2,5"/70/75/3"/80/85/90/100/105/4"/120/5"/130/6"/150/160/165/200mm (type-dependent)
- Application examples: HSC and HPC machining, model, mould and tool making, drilling/reaming/finishing/roughing, machining of wood

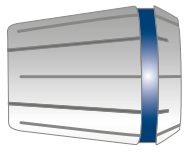

Collet

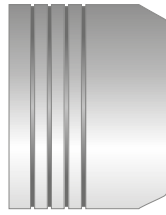

Clamping nut

Cooling

Suitable for all possible methods of supplying cooling lubricant.

The central component of the FAHRION modular kit, the collet, is available in several versions differing in accuracy, area of application and coolant application.

Since the chuck body is supplied without clamping nuts, these must be ordered separately. You have the choice between the standard version and the version for sealing discs!

- central (AD)
- laterally via the collar (C)
- minimum-quantity lubrication (MQL)
- air cooling
- peripheral cooling along the shaft by means of larger sealing disc

Pull Stud
 DIN 69872 Form A
 Cooling lubricant supply through the centre
 Form AD/BT

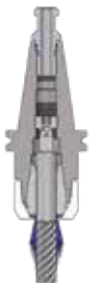

Pull Stud
 DIN 69872 Form B
 Cooling lubricant supply via the collar
 Form B/BTB

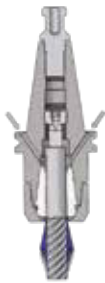

GERC-HP
 Precision Collet 2 μm
 DIN ISO 15488 - B(ER/ESX)



GERC-HPD
 Precision Collet 2 μm
 similar to DIN ISO 15488 - A with
 Seals for IC (inner coolant supply)



GERC-HPDD
 Precision Collet 2 μm
 similar to DIN ISO 15488 - A
 with seals for IC (inner coolant supply) and jet holes



GERC-GBD
 Tap Collet
 similar to DIN ISO 15488 - A
 with internal square drive and
 seals for IC (inner coolant supply)



GERC -GBDD
 Tap Collet
 similar to DIN ISO 15488 - A with
 internal square drive, seals for IC
 (inner coolant supply) and jet holes

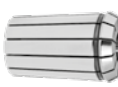

GOZ-DG-HP
 Precision Collet 3 μm
 DIN ISO 10897 - B

Technical Information



The chucks marked with MQL are suitable for minimum quantity lubrication. In MQL the required amount of lubricant for the cutting tool is reduced to a minimum by means of a dosing technique. This is supplied to the cutting point either directly or finely dispersed via an air stream. After clarification of all technical details we can convert MQL-compatible chucks.

Table for converting inches to mm
 see page 83

Blue ring = quality

The blue ring indicates our 2 μm precision collet.



Straight.

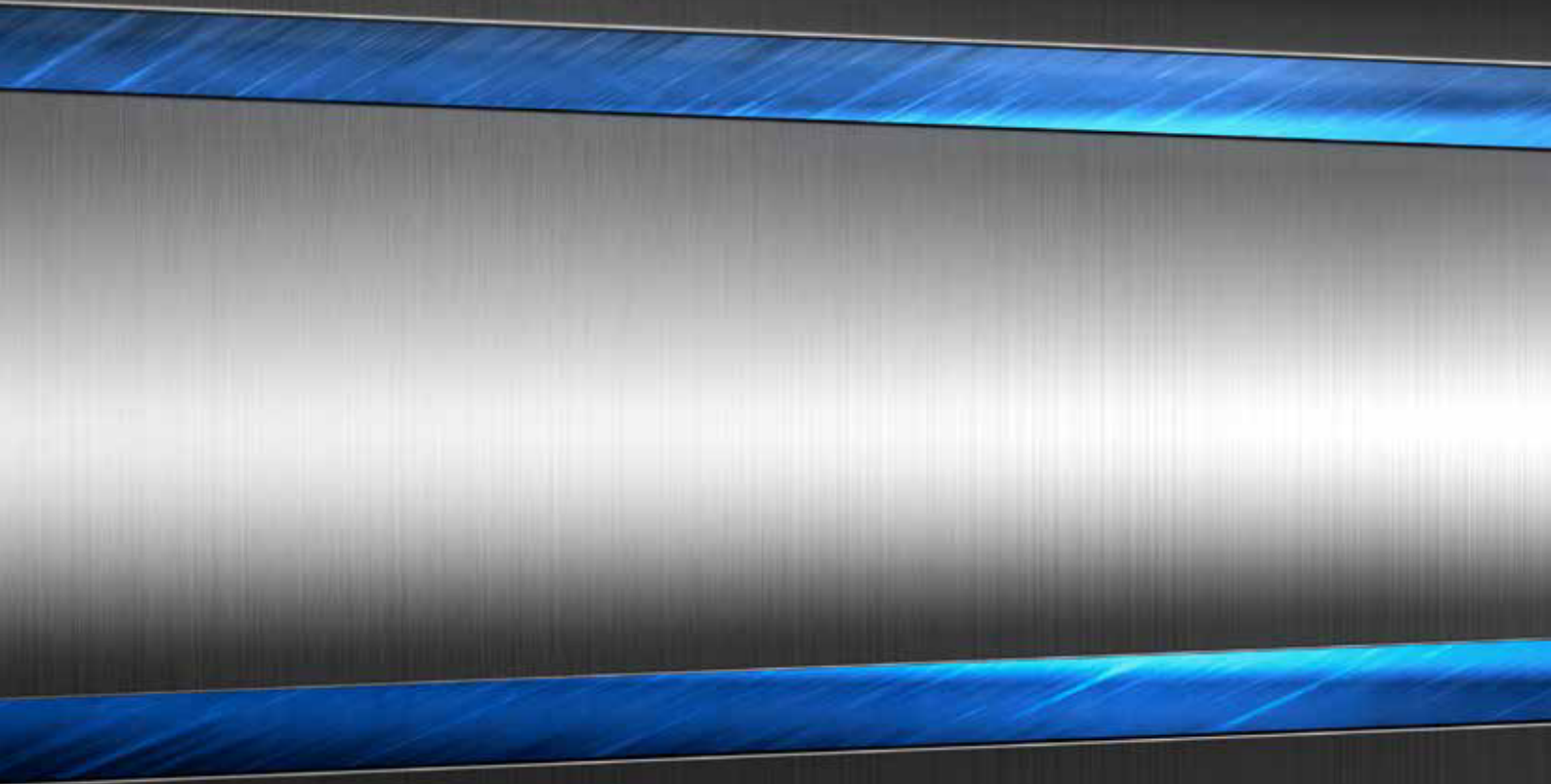

The direct way to success: Due to a uniquely clear and specific design, supreme production quality and consistent service orientation, FAHRION makes your work easier, more efficient, faster and more precise with its comprehensive range of tool clamping systems. Just right for demanding production tasks.

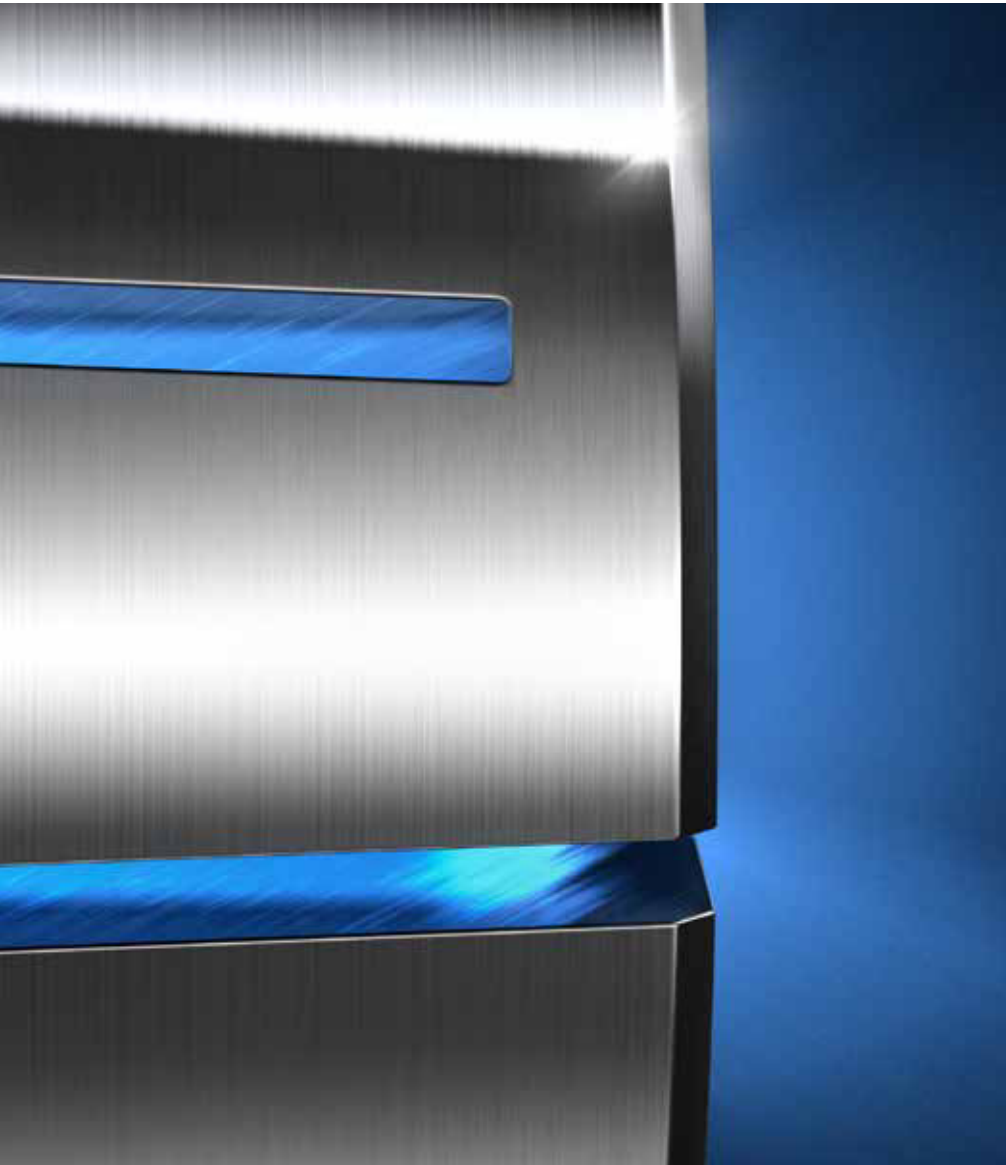

Close to your demands:
Every detail is optimized for
maximum functionality.

For decades, FAHRION has been following an uncompromising line, when it comes to supporting your work: All FAHRION products and services are directed to convince with maximum functionality and application orientation – at an excellent price-performance ratio.

In terms of quality, FAHRION products offer performance values already in the standard product range which for other producers are limited to expensive premium series. Our DIN ISO 15488 (ER/ESX) and DIN ISO 10897 (OZ) based precision collets are produced with tolerance values which lie significantly below the required DIN norm.

Together with the patented FAHRION precision collet chuck CENTRO|P and other high performance system components, our collets form a perfectly integrated complete system which guarantees maximum precision, stability, flexibility, reliability and cost effectiveness.

At the same time FAHRION is a manufacturer which continuously and critically monitors and optimizes its product portfolio – therefore, FAHRION technology brings you the maximum possible benefit at any time and with every order.

Evident.



FAHRION clamping systems can manage highly complex challenges. At the same time we have done everything to ensure that our solutions remain conceivably uncomplicated and highly transparent for you. This way, you can assure a distinct advantage in terms of profitability.

Focused on the user

FAHRION user-friendliness starts with the product range. We provide exactly those solutions which you need in your daily work – and only technology which really provides functionality enters FAHRION's clamping systems.

In addition to the common models, we do not only offer products which meet very special process requirements, but which can, nevertheless, be also easily assembled and effectively used. We support you with all our expertise in finding and using your dedicated FAHRION solution – for example in the FAHRION Technology Centre, where we convey broad know-how under real working conditions.

Smooth.



All runs smoothly – with excellent results: That is our promise to everyone who trusts in FAHRION clamping systems. Production processes with FAHRION solutions provide exactly those results which meet your specifications – with especially careful use of your valuable machinery.

Optimize your process

Excellent concentricity and repeatability, optimal balancing quality, perfectly matched and carefully tested system solutions: These are only a few of the technical features which assure that you can completely rely on FAHRION products.

Thanks to the smooth production processes in the highest quality, you can deliver the requested parts more quickly to your customers, while customer satisfaction ensures profitable follow-up orders. In addition, less process steps are required because the FAHRION precision reduces the number of faulty products – and thus the need for post processing work – to a minimum. Moreover, long service life of machine and tools is guaranteed with your own machine technology.

FAHRION|Protect



Rust on collets reduces the lifetime of your tools and leads to significant loss of precision. Therefore, we have now developed FAHRION|Protect: A pioneering new technology which protects collets from corrosion in the long term.



Collets with corrosion protection of the functional surfaces in the μ -range

FAHRION|Protect goes beyond all standards that you know in corrosion protection of clamping tools. Many clamping tools are not protected at all. With others, the corrosion protection is limited to the visible areas only. Or with cutting tools with insert pockets, only an accuracy of about 0.01 mm is required.

FAHRION is the first manufacturer to offer a coating of the functional surfaces in the μ -range – over its complete and finely tuned product range. FAHRION|Protect conserves FAHRION collets effectively from external influences and preserves their functionality and precision for a longer time. That is how FAHRION shows once again in an impressive way how advanced technology can be brought to the market as an integrated customer solution.



Two collets each after 4 months of use:
 The left one without coating – the right one with FAHRION|Protect

FAHRION|Protect:
Stops corrosion. Solves the problems.

The comparison with conventional unprotected collets shows: Without a coating, the collet is affected by corrosion in a short time – whether by humidity, cooling lubricant, cleaning solutions, salts or gases. This does not only affect the collet but also your complete system.

Optimize your work in many ways:

Coated collets by FAHRION are corrosion protection, quality protection, investment protection and environmental protection all in one:

- The nominal geometry between the collet and the taper seat in the chuck is maintained for a long lasting permanent surface contact without corrosion-related irregularities.
- The parts in manufacturing stay longer in the specified tolerances. The number of faulty parts decreases.
- You can keep production processes longer on a high level, you can save time and you can also guarantee short terms of delivery.
- A higher concentricity extends the tool lives. Thus, you save time and money by reducing set up times.
- Collets have to be replaced less frequently or can be used longer for precision applications.
- Less imbalance on the tools relieves the machine spindle permanently – your maintenance costs will be reduced.
- Longer service life saves valuable resources.

The new technology is established in the FAHRION factory and integrated in the production process. This means: no matter in which field or which type of collets you use – you can benefit from the new technology in any case

The FAHRION Product Range

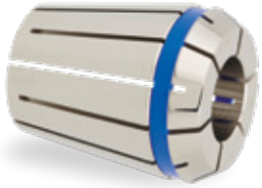

Precision Collets



Precision Collet Chucks CENTRO|P



Tapping Chucks SYNCHRO|T

The FAHRION Precision Collet

The heart of the technology is the collet: For many years, the combination of a specially manufactured steel and our unique production technology has enabled FAHRION to manufacture top-quality collets according to DIN ISO15488 (ER/ESX) in an outstanding quality with a maximum accuracy of 2 μm .

The FAHRION CENTRO|P Precision Collet Chuck

The CENTRO|P's legendary reputation on the market is no coincidence. It is one of the best collet chucks that money can buy. Combined with the FAHRION collets, which are perfectly matched to this chuck, it achieves a system accuracy of 3 μm and avoids the need to use expensive hydraulic expansion and shrinking techniques. In this catalogue we explain in detail the many different benefits of this technology with regard to accuracy, holding force, flexibility and price-performance ratio.

The FAHRION SYNCHRO|T Tapping Chuck

By compensating the pitch differences or tolerances of the tap and the synchronous spindle, the machining results can be optimised while maintaining quality and cost-effectiveness. A special tapping chuck with minimum length compensation is required for this.

CENTRO|P – Greater profitability through unique precision

Although it costs more than a standard collet chuck, a precision collet chuck wins by a mile in terms of cost-effectiveness. With maximum precision you achieve better machining results with considerably smaller manufacturing tolerances, thus saving expensive reworking. In addition, precision means that longer service lives of the cutting tools are achieved and that the machine spindle is preserved even during the most complex work. There are convincing reasons that it pays off in a short time to purchase precision collet chucks. Due to the system accuracy of 3 µm the CENTRO|P does not only stand at the top of precision, but also for long-term cost savings.

Effect of runout on the cutting edges

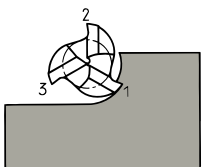

Irregular load on the cutting edges

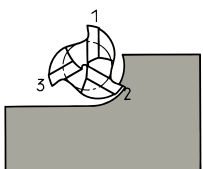

Wear on tool increases, surface quality of the workpiece is getting worse

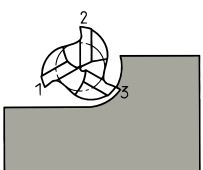

Feed has to be reduced

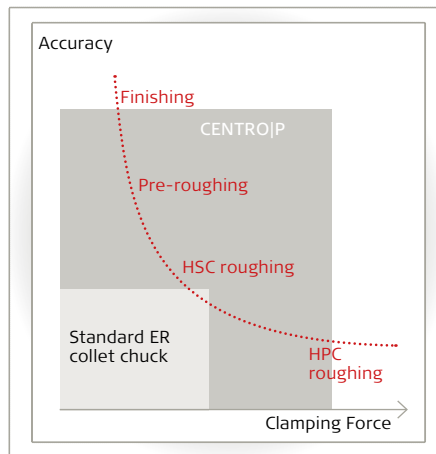

Accuracy and Holding Force

The FAHRION CENTRO|P belongs to the absolute top class of collet chucks. Unique, patented design features achieve a far higher accuracy than conventional ER collet chucks. Furthermore the system provides impressively higher holding forces. So the CENTRO|P can be used in a much wider field of applications.



Optimum Design

Due to well-thought-out chuck design, we achieve maximum symmetry with minimum residual imbalance. Further design features are the ground 30° trapezoidal thread and the special coating of the nut, which reduce friction and, together with the double guiding, ensure accurate centring of the nut on the chuck.

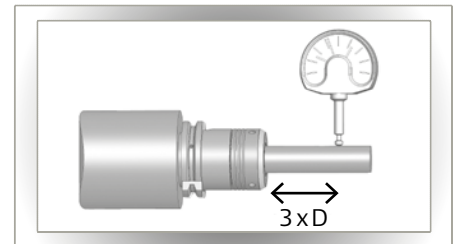

High Concentricity and Repeatability

Together with the FAHRION GERC-HP Precision Collets an outstanding system accuracy of 3 µm is reached (at 3xD, max. 50 mm). Consequence: You achieve up to six times the precision of a conventional ER collet chuck.

Maximum Balancing Quality

The chuck is a central element for the dampening of vibrations in the system of machine spindle, tool holder and tool. For this reason great importance is attached to the balancing quality of CENTRO|P Precision Collet Chucks. They are finely balanced for speeds up to 60.000 rpm, thus achieving maximum dimensional accuracy, surface quality and tool service lives.

Technology with more gripping power.

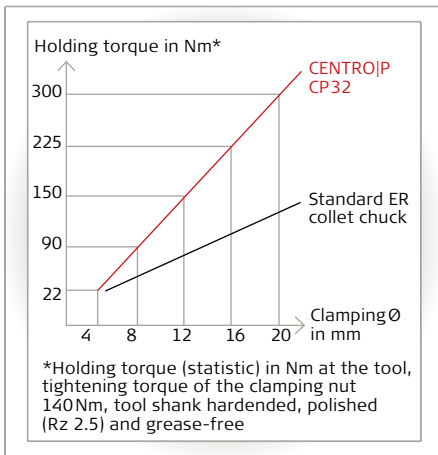
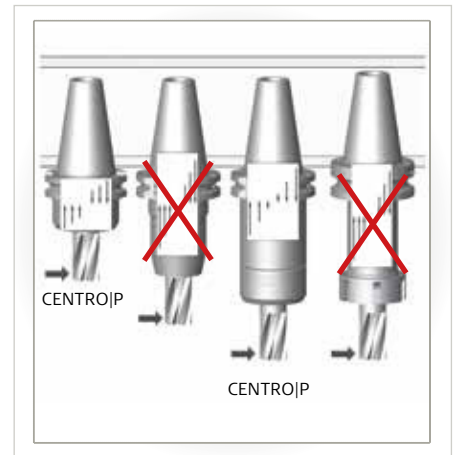
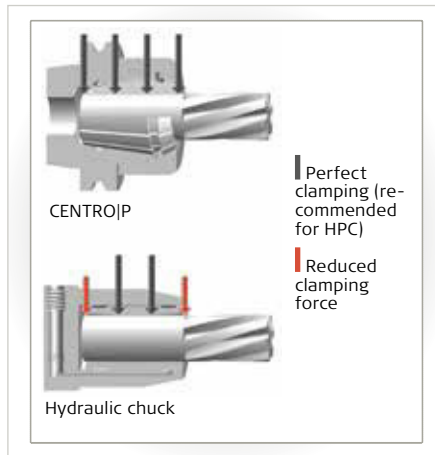
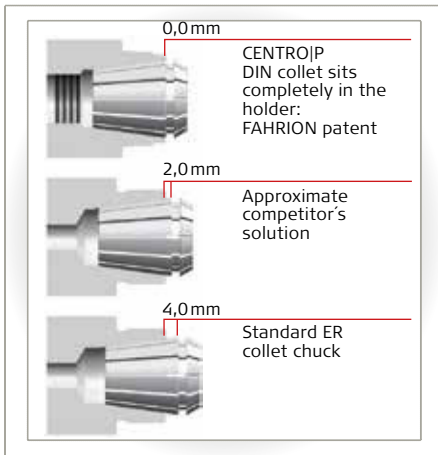

High Holding Force

In FAHRION's patented collet system the collet sits completely inside the collet closing taper. Due to the unique design it does not apply the usual bridging, thus enabling holding forces twice as high as those of conventional collet chucks. The ground trapezoidal thread, the polished surface of the collet and the finish in the bore of the collet further increase the holding forces. This ensures high security and enables rough machining with optimum results.

Immense Stability

The special design of the CENTRO|P achieves a better and more even distribution of the clamping forces over the entire cylindrical surface of the tool shank and the radial forces are optimally absorbed. So milling operations produce perfect surfaces.

High Rigidity

The reduction of bending and compressive forces creates an enormous stability. This principle was used and put into practice by the construction of CENTRO|P. The chuck body is reinforced to the diameter of the clamping nut, leading to maximum rigidity and an optimum interference contour.

Strong and Insensitive

Even insensitivity is a strong point. The CENTRO|P is resistant to temperature fluctuations and is fully suitable for dry processes and hard milling up to 200°C.

System intelligence in every detail

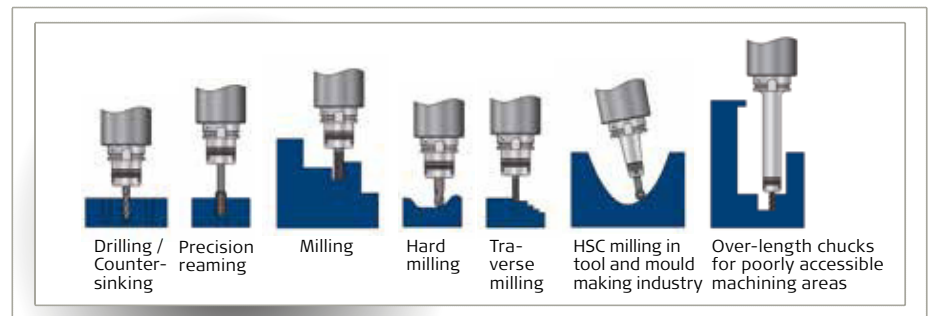
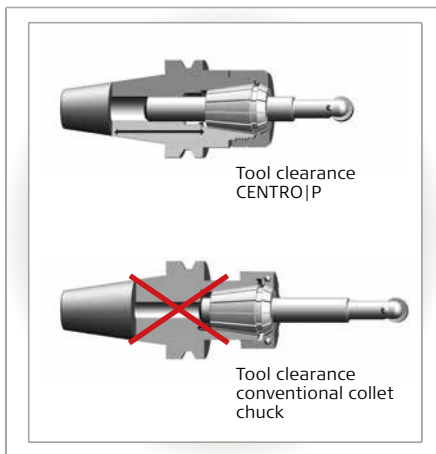

Greatest Possible Dampening

The constructive principle of our collets absorbs vibrations. The mass of the chuck optimizes the dampening even further. This conserves the machine and the spindle and extends the warranty.

Environmental Protection

Even when it comes to the economical use of energy and resources, FAHRION technologies are groundbreaking. Thanks to its perfect concentricity, CENTRO|P reduces the power consumption of the spindle. Workpieces can be machined in a shorter time, as a result of which, less electricity is used. Dry machining is possible, saving the costs for water, cooling units, and disposal. In addition, tool wear is reduced, and the tools don't need to be replaced so often.

Simple Handling

Despite its many technical advantages, an ingeniously simple, mechanical collet chuck requires no peripheral devices. It can be clamped simply, quickly, and securely, using the roller bearing wrench. The high purchase costs for ancillary equipment can be dispensed with.

Variable Cooling

CENTRO|P is suitable for all methods of cooling lubricant supply (central, laterally via the collar, minimum quantity lubrication, air cooling or peripheral cooling along the tool shank, jet-holes).

Largest Possible Tool Clearance

The CENTRO|P is designed in such a way that it offers the largest possible tool clearance and thus an extra-long length adjustment range. Hence, the tool can be clamped at the optimum tool projection length, whereby vibration is prevented, the tool is preserved, and the surface finish is optimised.

Universally Usable

The CENTRO|P is ideal for drilling, countersinking, reaming, milling, for HPC / HSC, and for tapping.

Intelligent Clamping System

The clamping nut of the CENTRO|P is tightened with a roller bearing wrench. The clamping nuts are marked with the maximum torques, which depend on the diameter to be clamped. In principle the maximum tightening torques can be used; for finishing machining, however, we recommend tightening the clamping nut only to 50-70% of the maximum tightening torque in order to obtain the optimal machining results on account of a higher degree of dampening. The clamping nut itself is manufactured completely symmetrically and has no slots or holes.

On Request with Collapse

By means of a special clamping nut, a collapse up to 0.4 mm can be achieved with the GER-HP collet.

SYNCHRO|T – The Perfectly Optimised Tapping Chuck



The SYNCHRO|T Tapping Chuck compensates differences in pitch between the tap and the synchronous spindle as well as compensating the pitch tolerances of the tap. It provides for a cushioning effect between the tool and spindle during synchronised tapping (rigid tapping) on machining centres with synchronous spindles.

Versatile Properties

- = minimum length compensation on compression/tension (± 0.5 mm)
- = high radial rigidity due to double bearing
- = high concentricity
- = high clamping force due to clamping by tap collets with internal square drive
- = separate compression/tension mechanism
- = defined adjustable compressive/tensile forces

- = compact, wear-free design
- = long service life
- = internal coolant feed possible in all types
- = no clamping nuts for sealing discs are required when using coolant, since the FAHRION GERC-GBD Tap Collets are generally supplied with seals (usable up to 120 bar)
- = minimum quantity lubrication (MQL) possible on request

Advantages in Synchronous Tapping

- = absolute process reliability due to minimum length compensation
- = low risk of breakage
- = high service lives of the taps (up to 150% higher than with a rigid collet chuck)
- = improved thread quality
- = fewer machine downtimes

Conclusion

In order to achieve the optimum cutting result, the FAHRION SYNCHRO|T Tapping Chuck should be used on machines with synchronous spindles even where the latest controllers are involved so as to extend service life and improve quality.

Collet Chucks with Taper Shanks

DIN 69871-1 (DIN ISO 7388-1)-AD30

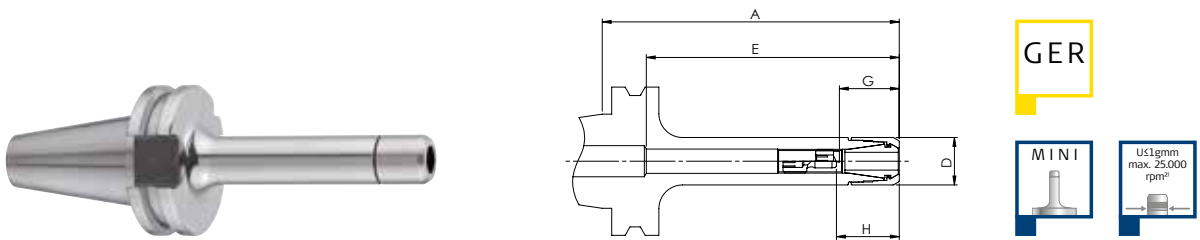

CENTRO|P – Slim Version for HPCM Mini Clamping Nuts

Description	Order-No.	Form	D	A ¹⁾	max. tool insertion depth without stop	Tool insertion depth with stop				Clamping Range / Collets	Clamping Nuts
						Type U		Type W			
						G max.	G min.	H max.	H min.		
CP11M-AD30-A=50	43213000500	AD	16	50	36	36	18	26	12	1,0-7,0 GERC11-HP/HPD	HPC11M• HPC11M-DI
CP11M-AD30-A=100	43213001000			100	85						

Accessories: Clamping Nuts page 62, Wrenches pages 67, 68, Mounting Devices page 68, Precision Collets pages 69, 70, Stop Screws page 76, Taper Wipers page 77, Pull Studs page 79

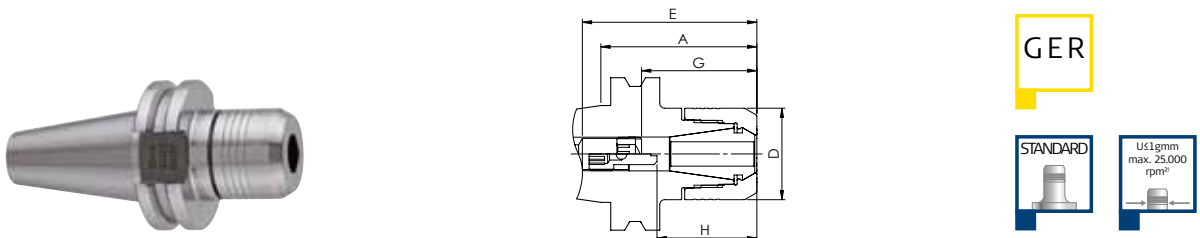

CENTRO|P – Version for HPC Clamping Nuts

Description	Order-No.	Form	D	A ¹⁾	max. tool insertion depth without stop	Tool insertion depth with stop				Clamping Range / Collets	Clamping Nuts	
						Type U		Type W				
						G max.	G min.	H max.	H min.			
CP16-AD30-A=50	44313000500	AD	30	50	56	45	28	31	16	1,0-10,0 GERC16-HP/HPD/GBD	HPC16• HPC16-DI	
CP16-AD30-A=100	44313001000			100	98							
CP25-AD30-A=70	44513000700		70	40	63	75	49	35	31	18	1,0-16,0 GERC25-HP/HPD/GBD	HPC25• HPC25-DI
CP32-AD30-A=70	44613000700				50	75						

Accessories: Clamping Nuts pages 64, 66, Wrenches pages 67, 68, Mounting Devices page 68, Precision Collets pages 69 - 71, Tap Collets pages 72, 73, Sealing Discs page 75, Stop Screws page 76, Taper Wipers page 77, Pull Studs page 79

¹⁾ Dimension A applies to Clamping Nuts without Sealing Discs. For Clamping Nuts with Sealing Discs see dimension A¹⁾ under Clamping Nuts on pages 62, 64 and 66
²⁾ Please refer to page 84 onwards regarding the subject of balancing. The max. rpm is depending on the length and the weight of each chuck.

Collet Chucks with Taper Shanks

DIN 69871-1 (DIN ISO 7388-1) – AD40 | AD/B40

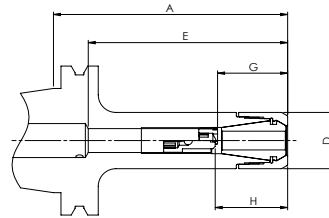

CENTROJP – Slim Version for HPCM Mini Clamping Nuts

Description	Order-No.	Form	D	A ¹⁾	max. tool insertion depth without stop	Tool insertion depth with stop				Clamping Range / Collets	Clamping Nuts
						Type U		Type W			
						E	G max.	G min.	H max.		
CP11M-B40-A=70	43214000700	AD/B	16	70	54	32	15	22	7	1,0–7,0 GERC11-HP/HPD	HPC11M• HPC11M-DI
CP11M-B40-A=100	43214001000			100	84	36	18	26	12		
CP11M-B40-A=130	43214001300			130	114	32	15	22	7		
CP11M-B40-A=160	43214001600			160	144	36	18	26	12		
CP16M-B40-A=70	43314000700		22	70	54	50	28	36	14	1,0–10,0 GERC16-HP/HPD/GBD	HPC16MS• HPC16MS-DI
CP16M-B40-A=100	43314001000			100	84						
CP16M-B40-A=130	43314001300			130	114						
CP16M-B40-A=160	43314001600			160	144						

Accessories: Clamping Nuts pages 62, 63, Wrenches pages 67, 68, Mounting Devices page 68, Precision Collets pages 69 - 71, Tap Collets pages 72, 73, Sealing Discs page 75, Stop Screws page 76, Taper Wipers page 77, Pull Studs pages 79, 80

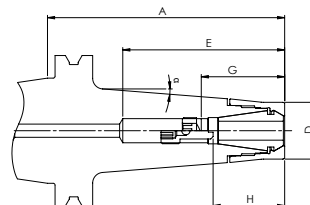

CENTROJP – Tapered Version for HPCC Special Clamping Nuts

Description	Order-No.	Form	D	A ¹⁾	α	max. tool insertion depth without stop	Tool insertion depth with stop				Clamping Range / Collets	Clamping Nuts
							Type U		Type W			
							E	G max.	G min.	H max.		
CPC16-B40-A=100	44314401000	AD/B	24	100	4,5	120	48	28	35	20	1,0–10,0 GERC16-HP/ HPD/GBD	HPC16C• HPC16C-DI
CPC16-B40-A=160	44314401600			160	2,5							

Accessories: Clamping Nuts page 63, Wrenches pages 67, 68, Mounting Devices page 68, Precision Collets pages 69 - 71, Tap Collets pages 72, 73, Sealing Discs page 75, Stop Screws page 76, Taper Wipers page 77, Pull Studs pages 79, 80

¹⁾ Dimension A applies to Clamping Nuts without Sealing Discs. For Clamping Nuts with Sealing Discs see dimension A¹⁾ under Clamping Nuts on pages 62 and 63
²⁾ Please refer to page 84 onwards regarding the subject of balancing. The max. rpm is depending on the length and the weight of each chuck.

Collet Chucks with Taper Shanks

DIN 69871-1 (DIN ISO 7388-1) – AD40|AD/B40

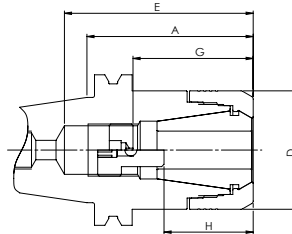

CENTRO|P – Version for HPC Clamping Nuts

Description	Order-No.	Form	D	A ¹⁾	max. tool insertion depth without stop	Tool insertion depth with stop				Clamping Range / Collets	Clamping Nuts													
						Type U		Type W																
						G max.	G min.	H max.	H min.															
CP16-AD40-A=70	44315000700	AD	30	70	55	45	28	31	16	1,0–10,0 GERC16-HP/HPD/GBD	HPC16• HPC16-DI													
CP16-B40-A=70	44314000700	AD/B		100	85							50	34	14										
CP16-AD40-A=100	44315001000	AD				AD/B	130	115	45						31	16								
CP16-B40-A=100	44314001000	AD/B															160	117	31	16				
CP16-B40-A=130	44314001300																				AD/B	200	157	31
CP16-B40-A=160	44314001600	AD/B				200	157	31	16															
CP16-B40-A=200	44314002000			AD/B	200							157	31	16										
CP20-AD40-A=70	44415000700	AD	32			70	100	56	36	42	32				1,0–13,0 GERC20-HP/HPD/GBD	HPC20• HPC20-DI								
CP20-AD40-A=100	44415001000	AD		32	100	130	58	36	45	32	1,0–13,0 GERC20-HP/HPD/GBD	HPC20• HPC20-DI												
CP20-B40-A=130	44414001300	AD/B	32		130	163	48	31	-	-	1,0–13,0 GERC20-HP/HPD/GBD	HPC20• HPC20-DI												
CP25-B40-A=45	44514000450	AD		40	45	87	60	35	42	20	1,0–16,0 GERC25-HP/HPD/GBD	HPC25• HPC25-DI												
CP25-AD40-A=70	44515000700	AD	70		114	67							38	49	21									
CP25-B40-A=70	44514000700	AD/B					AD/B	130	138	60						35	42	20						
CP25-AD40-A=100	44515001000	AD/B																	160	118	60	35	42	20
CP25-B40-A=100	44514001000																							
CP25-B40-A=130	44514001300	AD/B					200	148	60	35						42	20							
CP25-B40-A=160	44514001600		AD/B		200	148							60	35	42			20						
CP25-B40-A=200	44514002000	AD/B		200			148	60	35	42	20													
CP32-AD40-A=50	44615000500		AD		50	50						84	70	52	52	26	2,0–20,0 GERC32-HP/HPD/GBD	HPC32• HPC32-DI						
CP32-B40-A=50	44614000500	AD/B	70	99		75	55	62	42															
CP32-AD40-A=70	44615000700	AD								AD/B	100	114	70	52	32									
CP32-B40-A=70	44614000700	AD/B														130			135	74	42	55	28	
CP32-AD40-A=100	44615001000																							AD/B
CP32-B40-A=100	44614001000	AD/B								200	148	60	35	42	20									
CP32-B40-A=130	44614001300		AD/B	200		148	60	35	42							20								
CP32-B40-A=160	44614001600	AD/B			200					148	60	35	42	20										
CP40-AD40-A=70 ²⁾	44715000700		AD	63		70	83	55	48						-	-	3,0–26,0 GERC40-HP/HPD/GBD	HPC40• HPC40-DI						
CP40-AD40-A=100 ²⁾	44715001000	AD	63		100	83	62	48	-	-	3,0–26,0 GERC40-HP/HPD/GBD	HPC40• HPC40-DI												

Accessories: Clamping Nuts pages 64, 66, Wrenches pages 67, 68, Mounting Devices page 68, Precision Collets pages 69 - 71, Tap Collets pages 72, 73, Sealing Discs page 75, Stop Screws page 76, Taper Wipers page 77, Pull Studs pages 79, 80

¹⁾ Dimension A applies to Clamping Nuts without Sealing Discs. For Clamping Nuts with Sealing Discs see dimension A¹⁾ under Clamping Nuts on pages 64 and 66

²⁾ Without clearance to DIN 69871 in front of the tool change flange

³⁾ Please refer to page 84 onwards regarding the subject of balancing. The max. rpm is depending on the length and the weight of each chuck.

Collet Chucks with Taper Shanks

DIN 69871-1 (DIN ISO 7388-1) – AD40 | AD/B40

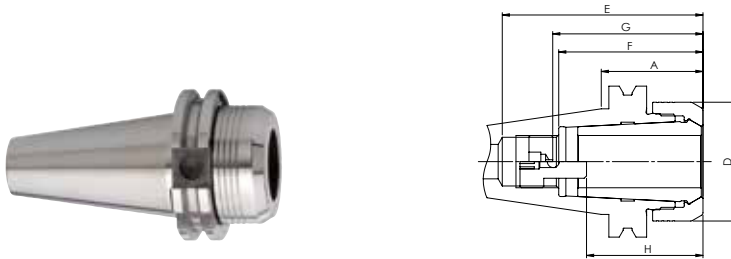

CENTROIP – Version for HPC Clamping Nuts

Description	Order-No.	Form	D	A ¹⁾	max. tool insertion depth without stop		Tool insertion depth with stop				Clamping Range / Collets	Clamping Nuts
					E ²⁾	F ²⁾	Type U		Type W			
							G max.	G min.	H max.	H min.		
CP225DG-B40-A=40	48414000400	AD/B	50	40	80	59	65	53	48	37	2,0–25,0 FM25DG•HP	HPC225• HPC225-DIG

Accessories: Clamping Nuts page 65, Wrenches pages 67, 68, Mounting Devices page 68, Precision Collets page 74, Sealing Discs page 75, Stop Screws page 76, Pull Studs pages 79, 80

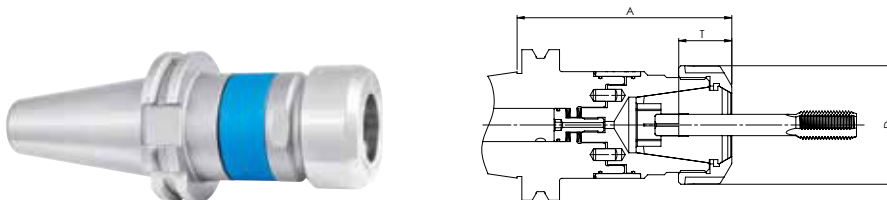

SYNCHROIT

Description	Order-No.	Form	D	A	Tap insertion depth T				Cutting range	Collets
					Shank-ø	Shank-ø	Shank-ø	Shank-ø		
					2,8–7,1	8–9	10–16	18–25		
ST16-GB-B40-A=79	52314000790	AD/B	30	79	-	-	-	-	M3–M12	GERC16-GBD
ST25-GB-B40-A=84	52514000840		40	84	18	22	25	-	M3–M20	GERC25-GBD
ST32-GB-B40-A=95	52614000950		50	95	-	-	-	30	M4–M27	GERC32-GBD

Accessories: Wrenches pages 67, 68, Mounting Devices page 68, Tap Collets pages 72, 73, Taper Wipers page 77, Pull Studs pages 79, 80

¹⁾ Dimension A applies to Clamping Nuts without Sealing Discs. For Clamping Nuts with Sealing Discs see dimension A¹⁾ under Clamping Nuts on page 65

²⁾ Dimension E is for tool shanks ≤ 20 mm and dimension F is for tool shanks > 20 mm

³⁾ Please refer to page 84 onwards regarding the subject of balancing. The max. rpm is depending on the length and the weight of each chuck.

Collet Chucks with Taper Shanks

DIN 69871 -1 (DIN ISO 7388-1) – AD50 | AD/B50

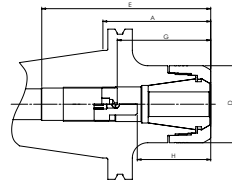

CENTRO|P – Version for HPC Clamping Nuts

Description	Order-No.	Form	D	A ¹⁾	max. tool insertion depth without stop	Tool insertion depth with stop				Clamping Range / Collets	Clamping Nuts	
						Type U		Type W				
						G max.	G min.	H max.	H min.			
CP16-AD50-A=70	44317000700	AD	30	70	90	45	28	35	16	1,0–10,0 GERC16-HP/HPD/GBD	HPC16• HPC16-DI	
CP16-AD50-A=100	44317001000			100	120	55		41				
CP16-AD50-A=160	44317001600			160	180							
CP25-AD50-A=70	44517000700		40	70	90	64	35	48	20	1,0–16,0 GERC25-HP/HPD/GBD	HPC25• HPC25-DI	
CP25-AD50-A=100	44517001000			100	120							
CP25-AD50-A=160	44517001600			160	180							
CP32-B50-A=70	44616000700	AD/B	50	70	109	85	59	70	40	2,0–20,0 GERC32-HP/HPD/GBD	HPC32• HPC32-DI	
CP32-B50-A=100	44616001000			100	120	81		53				63
CP32-B50-A=160	44616001600			160	150	83						65
CP40-B40-A=70	44716000700	AD/B	63	70	93	60	48	-	-	3,0–26,0 GERC40-HP/HPD/GBD	HPC40• HPC40-DI	
CP40-B40-A=100	44716001000			100	96	70						

Accessories: Clamping Nuts pages 64, 66, Wrenches pages 67, 68, Mounting Devices page 68, Precision Collets pages 69 - 71, Tap Collets pages 72, 73, Sealing Discs page 75, Stop Screws page 76, Taper Wipers page 77, Pull Studs pages 79, 80

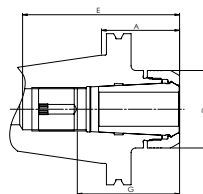

CENTRO|P – Version for HPC Clamping Nuts

Description	Order-No.	Form	D	A ¹⁾	max. tool insertion depth without stop	Tool insertion depth with stop				Clamping Range / Collets	Clamping Nuts
						Type U		Type W			
						G max.	G min.	H max.	H min.		
CP225DG-B50-A=50	48416000500	AD/B	50	50	110	66	55	-	-	2,0–25,0 FM25DG•HP	HPC225• HPC225-DIG
CP432DG-B50-A=50	48716000500		63			70	62	-	-	4,0–32,0 FM32DG	HPC432• HPC432-DIG

Accessories: Clamping Nuts page 65, Wrenches pages 67, 68, Mounting Devices page 68, Precision Collets page 74, Sealing Discs page 75, Stop Screws page 76, Pull Studs pages 79, 80

¹⁾ Dimension A applies to Clamping Nuts without Sealing Discs. For Clamping Nuts with Sealing Discs see dimension A¹⁾ under Clamping Nuts on pages 64, 65 and 66
²⁾ Please refer to page 84 onwards regarding the subject of balancing. The max. rpm is depending on the length and the weight of each chuck.

Collet Chucks with Taper Shanks DIN 69871-1 (DIN ISO 7388-1) – AD50 | AD/B50

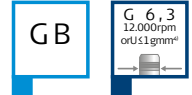
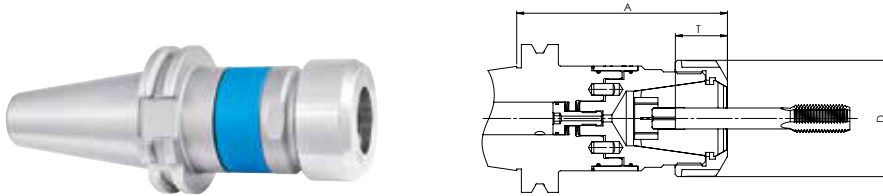

SYNCHROIT

Description	Order-No.	Form	D	A	Tap insertion depth T				Cutting range	Collets
					Shank-ø 2,8-7,1	Shank-ø 8-9	Shank-ø 10-16	Shank-ø 18-25		
ST25-GB-B50-A=84	52516000840	AD/B	40	84	18	22	25	-	M3-M20	GERC25-GBD
ST32-GB-B50-A=95	52616000950		50	95				30	M4-M27	GERC32-GBD

Accessories: Wrenches pages 67, 68, Mounting Devices page 68, Tap Collets pages 72, 73, Taper Wipers page 77, Pull Studs pages 79, 80

Collet Chucks with Hollow Tapers DIN 69893-1/ISO 12164-1 – HSK-A32

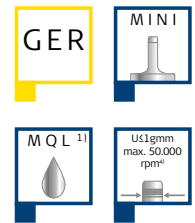
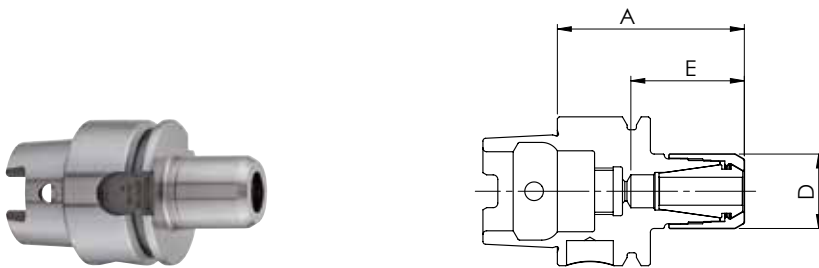

CENTROIP – Slim Version for HPCM Mini Clamping Nuts

Description	Order-No.	Form	D	A ²⁾	max. tool insertion depth without stop	Tool insertion depth with stop				Clamping Range / Collets	Clamping Nuts
						Type U		Type W			
						G max.	G min.	H max.	H min.		
CP11M-HSK-A32-A=40 ³⁾	43223000400	A	16	40	24	-	-	-	-	1,0-7,0 GERC11-HP/HPD	HPC11M• HPC11M-DI
CP16M-HSK-A32-A=50 ³⁾	43323000500		22	50	32	-	-	-	-	1,0-10,0	HPC16MS•
CP16M-HSK-A32-A=100	43323001000		100	67	67	44	27	30	14	GERC16-HP/HPD/GBD	HPCL6MS-DI

Accessories: Clamping Nuts pages 62, 63, Wrenches pages 67, 68, Mounting Devices page 68, Precision Collets pages 69 - 71, Tap Collets pages 72, 73, Sealing Discs page 75, Stop Screws page 76, Taper Wipers page 77, Coolant Supply Tubes and Wrenches page 78

¹⁾ MQL (minimal quantity lubrication) see page 5

²⁾ Dimension A applies to Clamping Nuts without Sealing Discs. For Clamping Nuts with Sealing Discs see dimension A¹⁾ under Clamping Nuts on pages 62 and 63

³⁾ Extra short version, without stop screw

⁴⁾ Please refer to page 84 onwards regarding the subject of balancing. The max. rpm is depending on the length and the weight of each chuck.

Collet Chucks with Hollow Tapers

DIN 69893-1/ISO12164-1 – HSK-A32

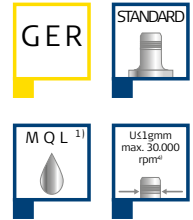
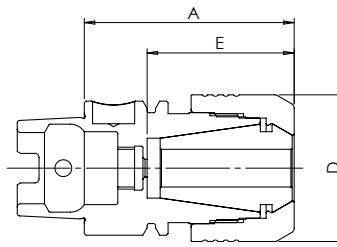

CENTRO|P – Version for HPC Clamping Nuts

Description	Order-No.	Form	D	A ²⁾	max. tool insertion depth without stop	Tool insertion depth with stop				Clamping Range / Collets	Clamping Nuts
						Type U		Type W			
						G max.	G min.	H max.	H min.		
CP20-HSK-A32-A=50 ³⁾	44423000500	A	32	50	35	-	-	-	-	1,0–13,0 GERC20-HP/HPD/GBD	HPC20• HPC20-DI

Accessories: Clamping Nuts pages 64, 66, Wrenches pages 67, 68, Mounting Devices page 68, Precision Collets pages 69 - 71, Tap Collets pages 72, 73, Sealing Discs page 75, Taper Wipers page 77, Coolant Supply Tubes and Wrenches page 78

Collet Chucks with Hollow Tapers

DIN 69893-1/ISO12164-1 – HSK-A40

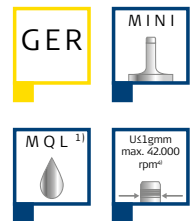
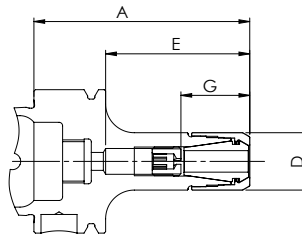

CENTRO|P – Slim Version for HPCM Mini Clamping Nuts

Description	Order-No.	Form	D	A ²⁾	max. tool insertion depth without stop	Tool insertion depth with stop				Clamping Range / Collets	Clamping Nuts
						Type U		Type W			
						G max.	G min.	H max.	H min.		
CP11M-HSK-A40-A=60	43224000600	A	16	60	40	24	16	-	-	1,0–7,0 GERC11-HP/HPD	HPC11M• HPC11M-DI
CP11M-HSK-A40-A=130	43224001300			130	75	32	22	7			

Accessories: Clamping Nuts page 62, Wrenches pages 67, 68, Mounting Devices page 68, Precision Collets pages 69, 70, Stop Screws page 76, Taper Wipers page 77, Coolant Supply Tubes and Wrenches page 78

¹⁾ MQL (minimal quantity lubrication) see page 5

²⁾ Dimension A applies to Clamping Nuts without Sealing Discs. For Clamping Nuts with Sealing Discs see dimension A¹⁾ under Clamping Nuts on pages 62, 64 and 66

³⁾ Extra short version, without stop screw

⁴⁾ Please refer to page 84 onwards regarding the subject of balancing. The max. rpm is depending on the length and the weight of each chuck.

Collet Chucks with Hollow Tapers

DIN 69893-1/ISO 12164-1 – HSK-A40

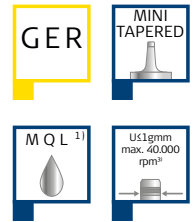
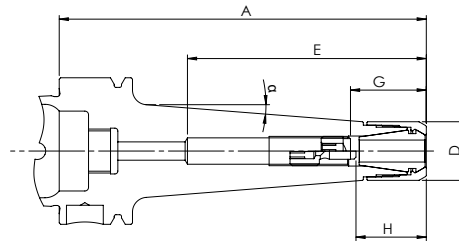

CENTRO|P – Tapered Version for HPCM Mini Clamping Nuts

Description	Order-No.	Form	D	A ²⁾	α	max. tool insertion depth without stop	Tool insertion depth with stop				Clamping Range / Collets	Clamping Nuts
							Type U		Type W			
							E	G max.	G min.	H max.		
CPC11M-HSK-A40-A=100	43224401000	A	16	100	4,5	65	34	15	25	8	1,0–7,0 GERC11-HP/ HPD	HPC11M• HPC11M-DI

Accessories: Clamping Nuts page 62, Wrenches pages 67, 68, Mounting Devices page 68, Precision Collets pages 69, 70, Stop Screws page 76, Taper Wipers page 77, Coolant Supply Tubes and Wrenches page 78

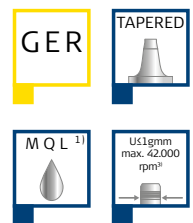
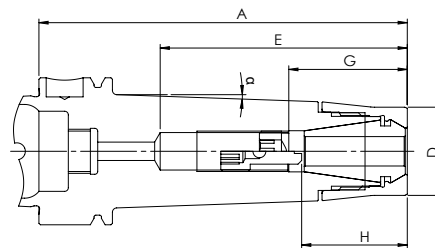

CENTRO|P – Tapered Version for HPCC Special Clamping Nuts

Description	Order-No.	Form	D	A ²⁾	α	max. tool insertion depth without stop	Tool insertion depth with stop				Clamping Range / Collets	Clamping Nuts
							Type U		Type W			
							E	G max.	G min.	H max.		
CPC16-HSK-A40-A=60	44324400600	A	24	60	2	43	30	26	-	-	1,0–10,0 GERC16-HP/ HPD/GBD	HPC16C• HPC16C-DI
CPC16-HSK-A40-A=100	44324401000			100			47		32	12		

Accessories: Clamping Nuts pages 63, Wrenches pages 67, 68, Mounting Devices page 68, Precision Collets pages 69 - 71, Tap Collets pages 72, 73, Sealing Discs page 75, Stop Screws page 76, Taper Wipers page 77, Coolant Supply Tubes and Wrenches page 78

¹⁾ MQL (minimal quantity lubrication) see page 5

²⁾ Dimension A applies to Clamping Nuts without Sealing Discs. For Clamping Nuts with Sealing Discs see dimension A¹⁾ under Clamping Nuts on pages 62 and 63

³⁾ Please refer to page 84 onwards regarding the subject of balancing. The max. rpm is depending on the length and the weight of each chuck.

Collet Chucks with Hollow Tapers

DIN 69893-1/ISO 12164-1 – HSK-A40

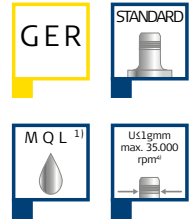
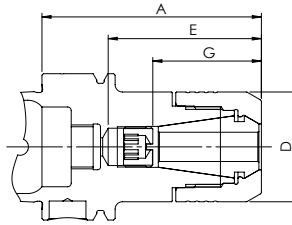

CENTRO|P – Version for HPC Clamping Nuts

Description	Order-No.	Form	D	A ²⁾	max. tool insertion depth without stop	Tool insertion depth with stop				Clamping Range / Collets	Clamping Nuts
						Type U		Type W			
						E	G max.	G min.	H max.		
CP16-HSK-A40-A=60	44324000600	A	30	60	40	32	28	-	-	1,0–10,0 GERC16-HP/HPD/GBD	HPC16• HPC16-DI
CP25-HSK-A40-A=60 ³⁾	44524000600		40	60	-	-	-	-	1,0–16,0 GERC25-HP/HPD/GBD	HPC25• HPC25-DI	
CP25-HSK-A40-A=100	44524001000		40	100	76	54	32	36	20	2,0–20,0 GERC32-HP/HPD/GBD	HPC32• HPC32-DI
CP32-HSK-A40-A=61 ³⁾	44624000610		50	61	45	-	-	-	-	2,0–20,0 GERC32-HP/HPD/GBD	HPC32• HPC32-DI

Accessories: Clamping Nuts pages 64, 66, Wrenches pages 67, 68, Mounting Devices page 68, Precision Collets pages 69 - 71, Tap Collets pages 72, 73, Sealing Discs page 75, Stop Screws page 76, Taper Wipers page 77, Coolant Supply Tubes and Wrenches page 78

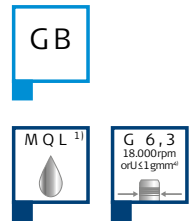
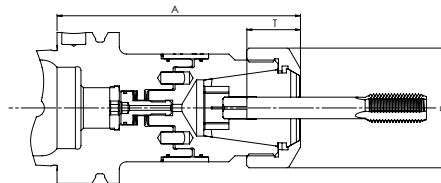

SYNCHRO|T

Description	Order-No.	Form	D	A	Tap insertion depth T				Cutting range	Collets
					Shank-ø 2,8–7,1	Shank-ø 8–9	Shank-ø 10–16	Shank-ø 18–25		
ST16-GB-HSK-A40-A=87	52324000870	A	30	87	18	22	-	-	M3–M12	GERC16-GBD

Accessories: Wrenches pages 67, 68, Mounting Devices page 68, Tap Collets pages 72, 73, Taper Wipers page 77, Coolant Supply Tubes and Wrenches page 78

¹⁾ MQL (minimal quantity lubrication) see page 5

²⁾ Dimension A applies to Clamping Nuts without Sealing Discs. For Clamping Nuts with Sealing Discs see dimension A¹⁾ under Clamping Nuts on pages 64 and 66

³⁾ Extra short version, without Stop Screw

⁴⁾ Please refer to page 84 onwards regarding the subject of balancing. The max. rpm is depending on the length and the weight of each chuck.

Collet Chucks with Hollow Tapers

DIN 69893-1/ISO12164-1 – HSK-A50

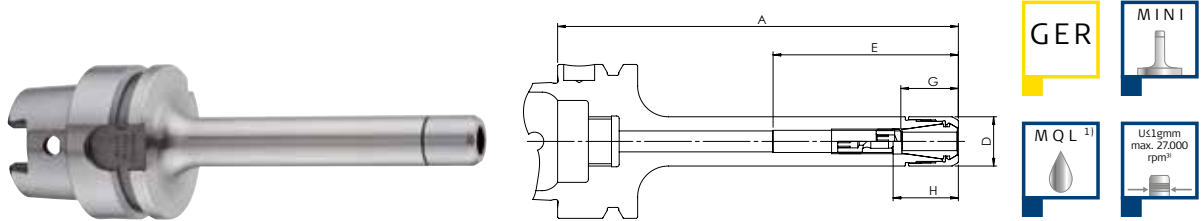

CENTRO|P – Slim Version for HPCM Mini Clamping Nuts

Description	Order-No.	Form	D	A ²⁾	max. tool insertion depth without stop	Tool insertion depth with stop				Clamping Range / Collets	Clamping Nuts
						Type U		Type W			
						G max.	G min.	H max.	H min.		
CP11M-HSK-A50-A=130	43225001300	A	16	130	60	32	15	22	7	1,0–7,0 GERC11-HP/HPD	HPC11M• HPC11M-DI

Accessories: Clamping Nuts page 62, Wrenches pages 67, 68, Mounting Devices page 68, Precision Collets pages 69, 70, Stop Screws page 76, Taper Wipers page 77, Coolant Supply Tubes and Wrenches page 78

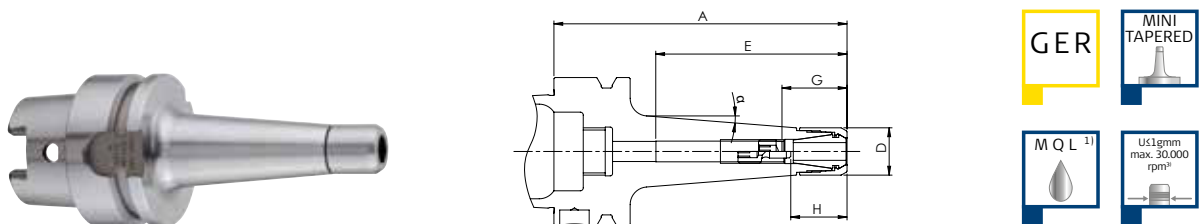

CENTRO|P – Tapered Version for HPCM Mini Clamping Nuts

Description	Order-No.	Form	D	A ²⁾	α	max. tool insertion depth without stop	Tool insertion depth with stop				Clamping Range / Collets	Clamping Nuts
							Type U		Type W			
							G max.	G min.	H max.	H min.		
CPC11M-HSK-A50-A=100	43225401000	A	16	100	4,5	65	34	15	25	8	1,0–7,0 GERC11-HP/ HPD	HPC11M• HPC11M-DI

Accessories: Clamping Nuts page 62, Wrenches pages 67, 68, Mounting Devices page 68, Precision Collets pages 69, 70, Stop Screws page 76, Taper Wipers page 77, Coolant Supply Tubes and Wrenches page 78

¹⁾ MQL (minimal quantity lubrication) see page 5

²⁾ Dimension A applies to Clamping Nuts without Sealing Discs. For Clamping Nuts with Sealing Discs see dimension A¹⁾ under Clamping Nuts on page 62

³⁾ Please refer to page 84 onwards regarding the subject of balancing. The max. rpm is depending on the length and the weight of each chuck.

Collet Chucks with Hollow Tapers

DIN 69893-1/ISO12164-1 – HSK-A50

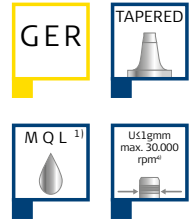
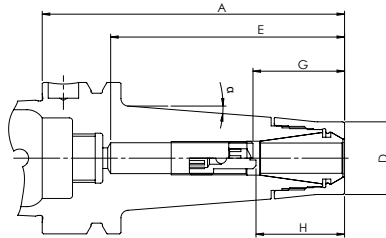

CENTROIP – Tapered Version for HPCC Special Clamping Nuts

Description	Order-No.	Form	D	A ²⁾	α	max. tool insertion depth without stop	Tool insertion depth with stop				Clamping Range / Collets	Clamping Nuts		
							Type U		Type W					
							E	G max.	G min.	H max.			H min.	
CPC16-HSK-A50-A=65	44325400650	A	24	65	4,5	44	32	28	-	-	1,0–10,0 GERC16-HP/ HPD/GBD	HPC16C• HPC16C-DI		
CPC16-HSK-A50-A=100	44325401000			100		77	38						36	14
CPC16-HSK-A50-A=130	44325401300			130		102	38							

Accessories: Clamping Nuts page 63, Wrenches pages 67, 68, Mounting Devices page 68, Precision Collets pages 69 - 71, Tap Collets pages 72, 73, Sealing Discs page 75, Stop Screws page 76, Taper Wipers page 77, Coolant Supply Tubes and Wrenches page 78

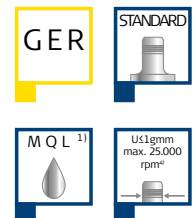
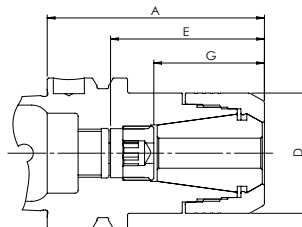

CENTROIP – Version for HPC Clamping Nuts

Description	Order-No.	Form	D	A ²⁾	max. tool insertion depth without stop	Tool insertion depth with stop				Clamping Range / Collets	Clamping Nuts
						Type U		Type W			
						E	G max.	G min.	H max.		
CP25-HSK-A50-A=60 ³⁾	44525000600	A	40	60	37	-	-	-	-	1,0–16,0 GERC25-HP/HPD/GBD	HPC25• HPC25-DI
CP25-HSK-A50-A=70	44525000700			70	49	35	34	35	20		
CP25-HSK-A50-A=100	44525001000			100	75	53					
CP32-HSK-A50-A=70 ³⁾	44625000700		50	70	47	-	-	-	-	2,0–20,0 GERC32-HP/HPD/GBD	HPC32• HPC32-DI

Accessories: Clamping Nuts pages 64, 66, Wrenches pages 67, 68, Mounting Devices page 68, Precision Collets pages 69 - 71, Tap Collets pages 72, 73, Sealing Discs page 75, Stop Screws page 76, Taper Wipers page 77, Coolant Supply Tubes and Wrenches page 78

¹⁾ MQL (minimal quantity lubrication) see page 5

²⁾ Dimension A applies to Clamping Nuts without Sealing Discs. For Clamping Nuts with Sealing Discs see dimension A¹⁾ under Clamping Nuts on pages 63, 64 and 66

³⁾ Extra short version, without Stop Screw

⁴⁾ Please refer to page 84 onwards regarding the subject of balancing. The max. rpm is depending on the length and the weight of each chuck.

Collet Chucks with Hollow Tapers

DIN 69893-1/ISO12164-1 – HSK-A50

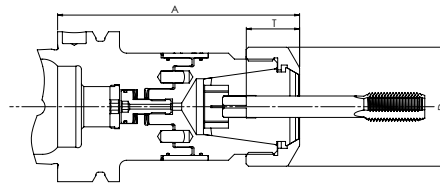

SYNCHROIT

Description	Order-No.	Form	D	A	Tap insertion depth T				Cutting range	Collets
					Shank- \emptyset 2,8 – 7,1	Shank- \emptyset 8 – 9	Shank- \emptyset 10 – 16	Shank- \emptyset 18 – 25		
ST16-GB-HSK-A50-A=87	52325000870	A	30	87	18	22	-	-	M3–M12	GERC16-GBD
ST25-GB-HSK-A50-A=92	52525000920		40	92			25		M3–M20	GERC25-GBD

Accessories: Wrenches pages 67, 68, Mounting Devices page 68, Tap Collets pages 72, 73, Taper Wipers page 77, Coolant Supply Tubes and Wrenches page 78

¹⁾ MQL (minimal quantity lubrication) see page 5

²⁾ Please refer to page 84 onwards regarding the subject of balancing. The max. rpm is depending on the length and the weight of each chuck.

Collet Chucks with Hollow Tapers

DIN 69893-1/ISO 12164-1 – HSK-A63

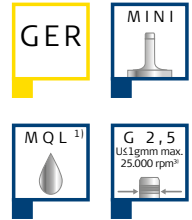
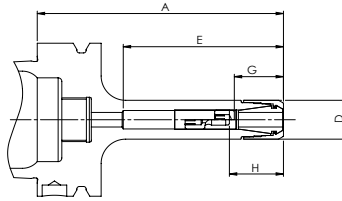

CENTRO|P – Slim Version for HPCM Mini Clamping Nuts

Description	Order-No.	Form	D	A ²⁾	max. tool insertion depth without stop	Tool insertion depth with stop				Clamping Range / Collets	Clamping Nuts
						Type U		Type W			
						G max.	G min.	H max.	H min.		
CP11M-HSK-A63-A=70	43226000700	A	16	70	48	32	15	22	7	1,0–7,0 GERC11-HP/HPD	HPC11M• HPC11M-DI
CP11M-HSK-A63-A=100	43226001000			100	78	36	18	26	12		
CP11M-HSK-A63-A=130	43226001300			130	108	32	15	22	7		
CP11M-HSK-A63-A=160	43226001600			160	138	36	18	26	12		
CP16M-HSK-A63-A=70	43326000700		22	70	46	34	27	20	1,0–10,0 GERC16-HP/HPD/GBD	HPC16MS• HPC16MS-DI	
CP16M-HSK-A63-A=100	43326001000			100	71	44		30			
CP16M-HSK-A63-A=130	43326001300			130	87	52	38				
CP16M-HSK-A63-A=160	43326001600			160	97						

Accessories: Clamping Nuts pages 62, 63, Wrenches pages 67, 68, Mounting Devices page 68, Precision Collets pages 69 - 71, Tap Collets pages 72, 73, Sealing Discs page 75, Stop Screws page 76, Taper Wipers page 77, Coolant Supply Tubes and Wrenches page 78

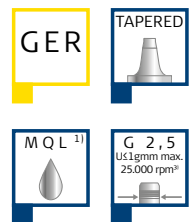
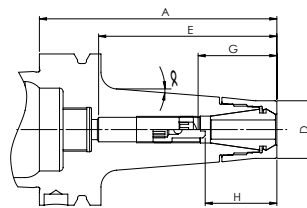

CENTRO|P – Tapered Version for HPCC Special Clamping Nuts

Description	Order-No.	Form	D	A ²⁾	α	max. tool insertion depth without stop	Tool insertion depth with stop				Clamping Range / Collets	Clamping Nuts
							Type U		Type W			
							G max.	G min.	H max.	H min.		
CPC16-HSK-A63-A=100	44326401000	A	24	100	4,5	75	48	28	35	20	1,0–10,0 GERC16-HP/ HPD/GBD	HPC16C• HPC16C-DI
CPC16-HSK-A63-A=160	44326401600			160	2,5	105						

Accessories: Clamping Nuts page 63, Wrenches pages 67, 68, Mounting Devices page 68, Precision Collets pages 69 - 71, Tap Collets pages 72, 73, Sealing Discs page 75, Stop Screws page 76, Taper Wipers page 77, Coolant Supply Tubes and Wrenches page 78

¹⁾ MQL (minimal quantity lubrication) see page 5

²⁾ Dimension A applies to Clamping Nuts without Sealing Discs. For Clamping Nuts with Sealing Discs see dimension A¹⁾ under Clamping Nuts on pages 62 and 63

³⁾ Please refer to page 84 onwards regarding the subject of balancing. The max. rpm is depending on the length and the weight of each chuck.

Collet Chucks with Hollow Tapers

DIN 69893-1/ISO12164-1 – HSK-A63

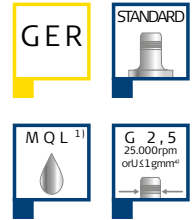
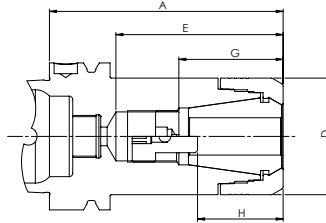
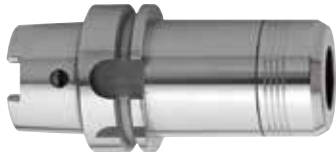

CENTROJP – Version for HPC Clamping Nuts

Description	Order-No.	Form	D	A ²⁾	max. tool in- sertion depth without stop	Tool insertion depth with stop				Clamping Range / Collets	Clamping Nuts			
						Type U		Type W						
						G max.	G min.	H max.	H min.					
CP16-HSK-A63-A=55 ³⁾	44326000550	A	30	55	32	-	-	-	-	1,0–10,0 GERC16-HP/HPD/GBD	HPC16• HPC16-DI			
CP16-HSK-A63-A=100	44326001000			100	71	45	28	31	16					
CP16-HSK-A63-A=130	44326001300			130	87	50	26	38	17					
CP16-HSK-A63-A=160	44326001600			160	106	45	28	31	16					
CP16-HSK-A63-A=200	44326002000			200	136									
CP20-HSK-A63-A=60 ³⁾	44426000600		32	60	35	-	-	-	-	1,0–13,0 GERC20-HP/HPD/GBD	HPC20• HPC20-DI			
CP20-HSK-A63-A=100	44426001000			100	70	38	31	-	-					
CP25-HSK-A63-A=60 ³⁾	44526000600			40	60	37	-	-	-			-	1,0–16,0 GERC25-HP/HPD/GBD	HPC25• HPC25-DI
CP25-HSK-A63-A=100	44526001000				100	70	55	35	37			24		
CP25-HSK-A63-A=130	44526001300				130	89	60	37	42			12		
CP25-HSK-A63-A=160	44526001600		160		128	60	35	42	24					
CP25-HSK-A63-A=200	44526002000		200		148									
CP32-HSK-A63-A=70 ³⁾	44626000700		50	70	46	-	-	-	-	2,0–20,0 GERC32-HP/HPD/GBD	HPC32• HPC32-DI			
CP32-HSK-A63-A=100	44626001000			100	71	57	41	39	26					
CP32-HSK-A63-A=130	44626001300			130	101	69	42	41	18					
CP32-HSK-A63-A=160	44626001600			160	129	70	52	60	26					
CP40-HSK-A63-A=80 ³⁾	44726000800			63	80	56	-	-	-			-	3,0–26,0 GERC40-HP/HPD/GBD	HPC40• HPC40-DI
CP40-HSK-A63-A=160	44726001600		160		130	75	48	-	-					

Accessories: Clamping Nuts pages 64, 66, Wrenches pages 67, 68, Mounting Devices page 68, Precision Collets pages 69 - 71, Tap Collets pages 72, 73, Sealing Discs page 75, Stop Screws page 76, Taper Wipers page 77, Coolant Supply Tubes and Wrenches page 78

¹⁾ MQL (minimal quantity lubrication) see page 5

²⁾ Dimension A applies to Clamping Nuts without Sealing Discs. For Clamping Nuts with Sealing Discs see dimension A¹⁾ under Clamping Nuts on pages 64 and 66

³⁾ Extra short version, without Stop Screw

⁴⁾ Please refer to page 84 onwards regarding the subject of balancing. The max. rpm is depending on the length and the weight of each chuck.

Collet Chucks with Hollow Tapers

DIN 69893-1/ISO 12164-1 – HSK-A63

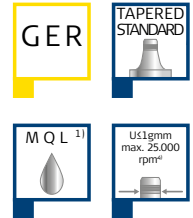
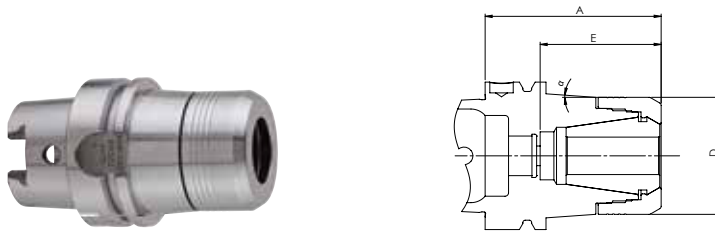

CENTROIP – Tapered Version for HPC Clamping Nuts

Description	Order-No.	Form	D	A ²⁾	α	max. tool insertion depth without stop E	Tool insertion depth with stop				Clamping Range / Collets	Clamping Nuts
							Type U		Type W			
							G max.	G min.	H max.	H min.		
CPC32-HSK-A63-A=75 ³⁾	44626400750	A	50	75	4	51	-	-	-	-	2,0–20,0 GERC32-HP/ HPD/GBD	HPC32• HPC32-DI

Accessories: Clamping Nuts pages 64, 66, Wrenches pages 67, 68, Mounting Devices page 68, Precision Collets pages 69 - 71, Tap Collets pages 72, 73, Sealing Discs page 75, Taper Wipers page 77, Coolant Supply Tubes and Wrenches page 78

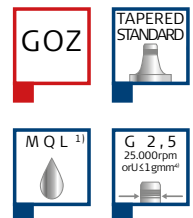

CENTROIP – Tapered Version for HPC Clamping Nuts

Description	Order-No.	Form	D	A ²⁾	α	max. tool insertion depth without stop E	Tool insertion depth with stop				Clamping Range / Collets	Clamping Nuts
							Type U		Type W			
							G max.	G min.	H max.	H min.		
CPC225DG-HSK-A63-A=85 ³⁾	48426400850	A	50	85	2,5	60	-	-	-	-	2,0–25,0 FM25DG•HP	HPC225• HPC225-DIG

Accessories: Clamping Nuts page 65, Wrenches pages 67, 68, Mounting Devices page 68, Precision Collets page 74, Sealing Discs page 75, Taper Wipers page 77, Coolant Supply Tubes and Wrenches page 78

¹⁾ MQL (minimal quantity lubrication) see page 5

²⁾ Dimension A applies to Clamping Nuts without Sealing Discs. For Clamping Nuts with Sealing Discs see dimension A¹⁾ under Clamping Nuts on pages 64, 65 and 66

³⁾ Extra short version, without Stop Screw

⁴⁾ Please refer to page 84 onwards regarding the subject of balancing. The max. rpm is depending on the length and the weight of each chuck.

Collet Chucks with Hollow Tapers

DIN 69893-1/ISO12164-1 – HSK-A63

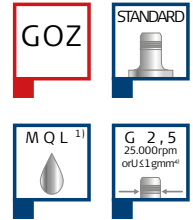
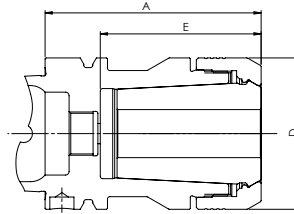

CENTROJP – Version for HPC Clamping Nuts

Description	Order-No.	Form	D	A ²⁾	max. tool insertion depth without stop	Tool insertion depth with stop				Clamping Range / Collets	Clamping Nuts
						Type U		Type W			
						G max.	G min.	H max.	H min.		
CP432DG-HSK-A63-A=90 ³⁾	48726000900	A	63	90	67	-	-	-	-	4,0–32,0 FM32DG	HPC432• HPC432-DIG

Accessories: Clamping Nuts page 65, Wrenches pages 67, 68, Mounting Devices page 68, Precision Collets page 74, Sealing Discs page 75, Taper Wipers page 77, Coolant Supply Tubes and Wrenches page 78

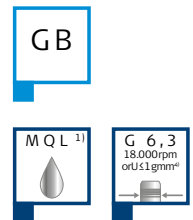
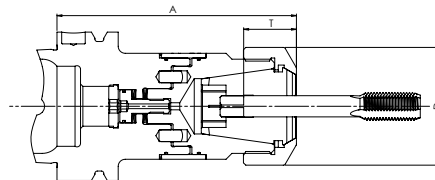

SYNCHROIT

Description	Order-No.	Form	D	A	Tap insertion depth T				Cutting range	Collets	
					Shank-ø	Shank-ø	Shank-ø	Shank-ø			
					2,8–7,1	8–9	10–16	18–25			
ST16-GB-HSK-A63-A=89	52326000890	A	30	89	18	22	25	30	-	M3–M12	GERC16-GBD
ST20-GB-HSK-A63-A=90	52426000900		32	90					-	M3–M16	GERC20-GBD
ST25-GB-HSK-A63-A=94	52526000940		40	94					-	M3–M20	GERC25-GBD
ST32-GB-HSK-A63-A=105	52626001050		50	105					-	M4–M27	GERC32-GBD

Accessories: Wrenches pages 67, 68, Mounting Devices page 68, Tap Collets pages 72, 73, Taper Wipers page 77, Coolant Supply Tubes and Wrenches page 78

¹⁾ MQL (minimal quantity lubrication) see page 5

²⁾ Dimension A applies to Clamping Nuts without Sealing Discs. For Clamping Nuts with Sealing Discs see dimension A¹⁾ under Clamping Nuts on page 65

³⁾ Extra short version, without Stop Screw

⁴⁾ Please refer to page 84 onwards regarding the subject of balancing. The max. rpm is depending on the length and the weight of each chuck.

Collet Chucks with Hollow Tapers

DIN 69893-1/ISO12164-1 – HSK-A80

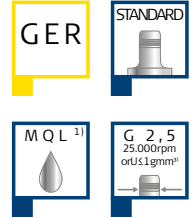
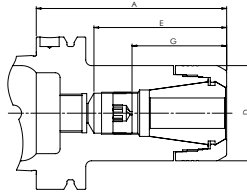

CENTROIP – Version for HPC Clamping Nuts

Description	Order-No.	Form	D	A ²⁾	max. tool insertion depth without stop	Tool insertion depth with stop				Clamping Range / Collets	Clamping Nuts
						Type U		Type W			
						G max.	G min.	H max.	H min.		
CP32-HSK-A80-A=100	44627001000	A	50	100	70	55	48	-	-	2,0–20,0 GERC32-HP/HPD/GBD	HPC32• HPC32-DI
CP40-HSK-A80-A=120	44727001200		63	120	86	54	35	-	-	3,0–26,0 GERC40-HP/HPD/GBD	HPC40• HPC40-DI

Accessories: Clamping Nuts pages 64, 66, Wrenches pages 67, 68, Mounting Devices page 68, Precision Collets pages 69 - 71, Tap Collets pages 72, 73, Sealing Discs page 75, Stop Screws page 76, Taper Wipers page 77, Coolant Supply Tubes and Wrenches page 78

¹⁾ MQL (minimal quantity lubrication) see page 5

²⁾ Dimension A applies to Clamping Nuts without Sealing Discs. For Clamping Nuts with Sealing Discs see dimension A¹⁾ under Clamping Nuts on pages 64 and 66

³⁾ Please refer to page 84 onwards regarding the subject of balancing. The max. rpm is depending on the length and the weight of each chuck.

Collet Chucks with Hollow Tapers

DIN 69893-1/ISO12164-1 – HSK-A100

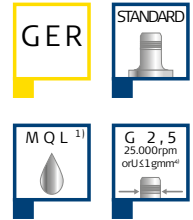
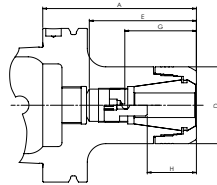

CENTROIP GER – Version for HPC Clamping Nuts

Description	Order-No.	Form	D	A ²⁾	max. tool insertion depth without stop	Tool insertion depth with stop				Clamping Range / Collets	Clamping Nuts
						Type U		Type W			
						E	G max.	G min.	H max.		
CP16-HSK-A100-A=100	44328001000	A	30	100	70	48	28	35	16	1,0–10,0	HPC16• HPC16-DI
CP16-HSK-A100-A=160	44328001600			160	130	-	-	-	-	GERC16-HP/HPD/GBD	
CP25-HSK-A100-A=100	44528001000		40	100	71	56	38	40	20	1,0–16,0	HPC25• HPC25-DI
CP25-HSK-A100-A=160	44528001600			160	105	68	-	50	-	GERC25-HP/HPD/GBD	
CP32-HSK-A100-A=100	44628001000		50	100	70	59	42	40	24	2,0–20,0	HPC32• HPC32-DI
CP32-HSK-A100-A=160	44628001600			160	99	70	-	52	-	GERC32-HP/HPD/GBD	
CP32-HSK-A100-A=200	44628002000			200	150	72	43	54	28		
CP40-HSK-A100-A=100 ³⁾	44728001000		63	100	65	-	-	-	-	3,0–26,0	HPC40• HPC40-DI
									GERC40-HP/HPD/GBD		

Accessories: Clamping Nuts pages 64, 66, Wrenches pages 67, 68, Mounting Devices page 68, Precision Collets pages 69 – 71, Tap Collets pages 72, 73, Sealing Discs page 75, Stop Screws page 76, Taper Wipers page 77, Coolant Supply Tubes and Wrenches page 78

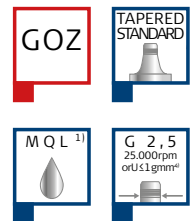
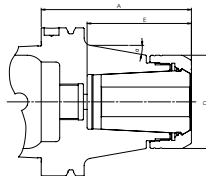

CENTROIP – Tapered Version for HPC Clamping Nuts

Description	Order-No.	Form	D	A ²⁾	max. tool insertion depth without stop	Tool insertion depth with stop				Clamping Range / Collets	Clamping Nuts
						Type U		Type W			
						E	G max.	G min.	H max.		
CPC225DG-HSK-A100-A=90 ³⁾	48428400900	A	50	90	60	-	-	-	-	2,0–25,0	HPC225• HPC225-DIG
CPC432DG-HSK-A100-A=100 ³⁾	48728401000		63	100	69	-	-	-	-	4,0–32,0	HPC432• HPC432-DIG

Accessories: Clamping Nuts page 65, Wrenches pages 67, 68, Mounting Devices page 68, Precision Collets page 74, Sealing Discs page 75, Taper Wipers page 77, Coolant Supply Tubes and Wrenches page 78

¹⁾ MQL (minimal quantity lubrication) see page 5

²⁾ Dimension A applies to Clamping Nuts without Sealing Discs. For Clamping Nuts with Sealing Discs see dimension A¹⁾ under Clamping Nuts on pages 64, 65 and 66

³⁾ Extra short version, without Stop Screw

⁴⁾ Please refer to page 84 onwards regarding the subject of balancing. The max. rpm is depending on the length and the weight of each chuck.

Collet Chucks with Hollow Tapers

DIN 69893-1/ISO12164-1- HSK-A100

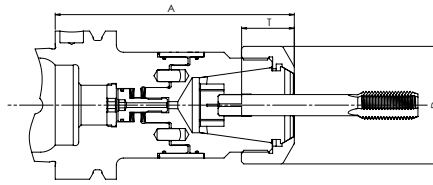

SYNCHROIT

Description	Order-No.	Form	D	A	Tap insertion depth T				Cutting range	Collets
					Shank- ϕ 2,8-7,1	Shank- ϕ 8-9	Shank- ϕ 10-16	Shank- ϕ 18-25		
ST25-GB-HSK-A100-A=101	52528001010	A	40	101	18	22	25	-	M3-M20	GERC25-GBD
ST32-GB-HSK-A100-A=110	52628001100		50	110				30	M4-M27	GERC32-GBD

Accessories: Wrenches pages 67, 68, Mounting Devices page 68, Tap Collets pages 72, 73, Taper Wipers page 77, Coolant Supply Tubes and Wrenches page 78

Collet Chucks with Hollow Tapers

DIN 69893-5- HSK-E25

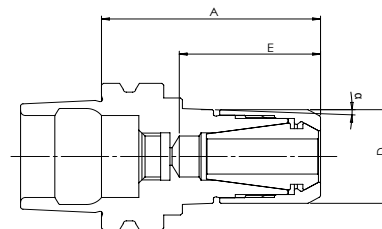

CENTROIP – Tapered Version for HPCM Mini Clamping Nuts

Description	Order-No.	Form	D	A ²⁾	α	max. tool insertion depth without stop E	Tool insertion depth with stop				Clamping Range / Collets	Clamping Nuts
							Type U		Type W			
							G max.	G min.	H max.	H min.		
CP8M-HSK-E25-A=35 ³⁾	43142000350	E	10	35	-	16	-	-	-	-	1,0-5,0 GERC8-HP	HPC8M
CP11M-HSK-E25-A=35 ³⁾	43242000351		16				2,5	22	-	-	-	-
CP16M-HSK-E25-A=45 ³⁾	43342000450		22	45	-	30	-	-	-	-	1,0-10,0 GERC16-HP/ HPD/GBD	HPC16MS• HPC16MS-DI

Accessories: Clamping Nuts pages 62, 63, Wrenches pages 67, 68, Mounting Devices page 68, Precision Collets pages 69 - 71, Tap Collets pages 72, 73, Sealing Discs page 75, Taper Wipers page 77, Coolant Supply Tubes and Wrenches page 78

¹⁾ MQL (minimal quantity lubrication) see page 5

²⁾ Dimension A applies to Clamping Nuts without Sealing Discs. For Clamping Nuts with Sealing Discs see dimension A¹⁾ under Clamping Nuts on pages 62 and 63

³⁾ Extra short version, without Stop Screw

⁴⁾ Please refer to page 84 onwards regarding the subject of balancing. The max. rpm is depending on the length and the weight of each chuck.

Collet Chucks with Hollow Tapers

DIN 69893-5 – HSK-E32

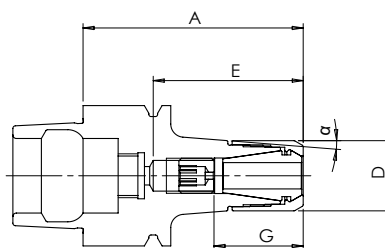

CENTROJP – Tapered Version for HPCM Mini Clamping Nuts

Description	Order-No.	Form	D	A ¹⁾	α	max. tool insertion depth without stop	Tool insertion depth with stop				Clamping Range / Collets	Clamping Nuts
							Type U		Type W			
							G max.	G min.	H max.	H min.		
CPC8M-HSK-E32-A=50 ²⁾	43143000500	E	10	50	-	30	-	-	-	1,0-5,0 GERC8-HP	HPC8M	
CPC11M-HSK-E32-A=50	43243000500		16			31	20	18	-	-	1,0-7,0 GERC11-HP/ HPD	HPC11M• HPC11M-DI
CPC16M-HSK-E32-A=55 ³⁾	43343000550		22	55	4,5	40	30	29	-	-	1,0-10,0 GERC16-HP/ HPD/GBD	HPC16MS• HPC16MS-DI

Accessories: Clamping Nuts pages 62, 63, Wrenches pages 67, 68, Mounting Devices page 68, Precision Collets pages 69 - 71, Tap Collets pages 72, 73, Sealing Discs page 75, Stop Screws page 76, Taper Wipers page 77, Coolant Supply Tubes and Wrenches page 78

¹⁾ Dimension A applies to Clamping Nuts without Sealing Discs. For Clamping Nuts with Sealing Discs see dimension A¹⁾ under Clamping Nuts on pages 62 and 63

²⁾ Extra short version, without stop screw

³⁾ Only Stop Screw AS-CP11-U (thread M8x1) possible

⁴⁾ Please refer to page 84 onwards regarding the subject of balancing. The max. rpm is depending on the length and the weight of each chuck.

Collet Chucks with Hollow Tapers

DIN 69893-5 – HSK-E40

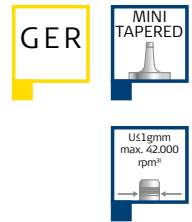
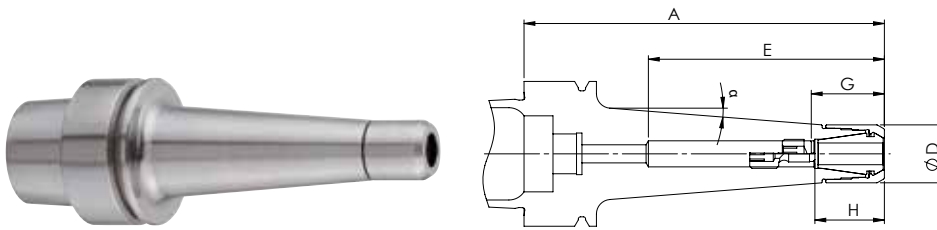

CENTRO|P – Tapered Version for HPCM Mini Clamping Nuts

Description	Order-No.	Form	D	A ¹⁾	α	max. tool insertion depth without stop	Tool insertion depth with stop				Clamping Range / Collets	Clamping Nuts
							Type U		Type W			
							E	G max.	G min.	H max.		
CPC11M-HSK-E40-A=50	43244000500	E	16	50	4,5	31	20	18	-	-	1,0–7,0 GERC11-HP/ HPD	HPC11M• HPC11M-DI
CPC11M-HSK-E40-A=100	43244001000			100		64	36	26	12			
CPC11M-HSK-E40-A=130	43244001300			130		65	33	19	23			
CPC11M-HSK-E40-A=160	43244001600			160		65	33	19	23			
CPC16M-HSK-E40-A=55	43344000550	E	22	55	2,5	38	30	28	20	12	1,0–10,0 GERC16-HP/ HPD/GBD	HPC16MS• HPC16MS-DI
CPC16M-HSK-E40-A=100	43344001000			100		66	48	38	38			

Accessories: Clamping Nuts pages 62, 63, Wrenches pages 67, 68, Mounting Devices page 68, Precision Collets pages 69 - 71, Tap Collets pages 72, 73, Sealing Discs page 75, Stop Screws page 76, Taper Wipers page 77, Coolant Supply Tubes and Wrenches page 78

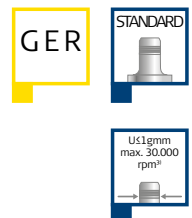
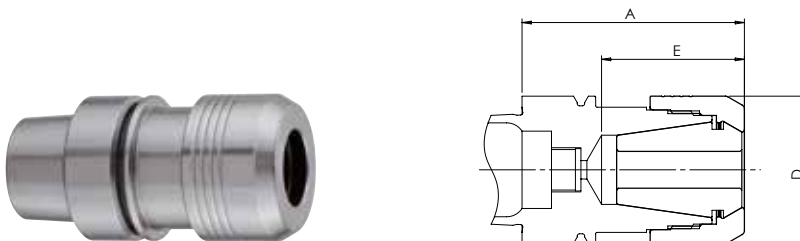

CENTRO|P – Version for HPC Clamping Nuts

Description	Order-No.	Form	D	A ¹⁾	max. tool insertion depth without stop	Tool insertion depth with stop				Clamping Range / Collets	Clamping Nuts
						Type U		Type W			
						E	G max.	G min.	H max.		
CP25-HSK-E40-A=60 ²⁾	44544000600	E	40	60	39	-	-	-	-	1,0–16,0 GERC25-HP/HPD/GBD	HPC25• HPC25-DI

Accessories: Clamping Nuts pages 64, 66, Wrenches pages 67, 68, Mounting Devices page 68, Precision Collets pages 69 - 71, Tap Collets pages 72, 73, Sealing Discs page 75, Taper Wipers page 77, Coolant Supply Tubes and Wrenches page 78

¹⁾ Dimension A applies to Clamping Nuts without Sealing Discs. For Clamping Nuts with Sealing Discs see dimension A¹⁾ under Clamping Nuts on pages 62, 63, 64 and 66
²⁾ Extra short version, without Stop Screw
³⁾ Please refer to page 84 onwards regarding the subject of balancing. The max. rpm is depending on the length and the weight of each chuck.

Collet Chucks with Hollow Tapers

DIN 69893-5 – HSK-E50

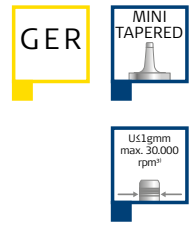
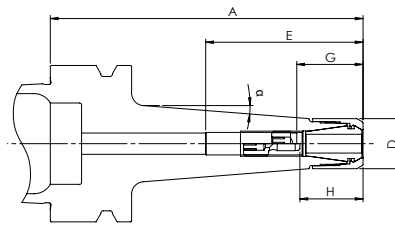

CENTRO|P – Tapered Version for HPCM Mini Clamping Nuts

Description	Order-No.	Form	D	A ¹⁾	α	max. tool insertion depth without stop	Tool insertion depth with stop				Clamping Range / Collets	Clamping Nuts
							Type U		Type W			
							G max.	G min.	H max.	H min.		
CPC11M-HSK-E50-A=60	43245000600	E	16	60	4,5	37	23	15	-	-	1,0–7,0 GERC11-HP/ HPD	HPC11M• HPC11M-DI
CPC11M-HSK-E50-A=100	43245001000			100		50	30	21	10			
CPC16M-HSK-E50-A=60	43345000600	E	22	60	2,5	39	31	28	21	12	1,0–10,0 GERC16-HP/ HPD/GBD	HPC16MS• HPC16MS-DI
CPC16M-HSK-E50-A=100	43345001000			100		72	48	35				

Accessories: Clamping Nuts pages 62, 63, Wrenches pages 67, 68, Mounting Devices page 68, Precision Collets pages 69 - 71, Tap Collets pages 72, 73, Sealing Discs page 75, Stop Screws page 76, Taper Wipers page 77, Coolant Supply Tubes and Wrenches page 78

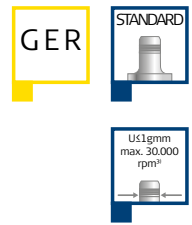
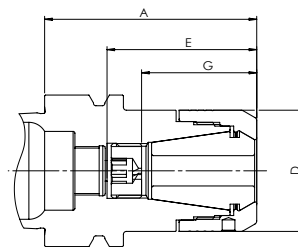

CENTRO|P – Version for HPC Clamping Nuts

Description	Order-No.	Form	D	A ¹⁾	max. tool insertion depth without stop	Tool insertion depth with stop				Clamping Range / Collets	Clamping Nuts
						Type U		Type W			
						G max.	G min.	H max.	H min.		
CP25-HSK-E50-A=70 ²⁾	44545000700	E	40	70	49	39	35	-	-	1,0–16,0 GERC25-HP/HPD/GBD	HPC25• HPC25-DI

Accessories: Clamping Nuts pages 64, 66, Wrenches pages 67, 68, Mounting Devices page 68, Precision Collets pages 69 - 71 Tap Collets pages 72, 73, Sealing Discs page 75, Stop Screws page 76, Taper Wipers page 77, Coolant Supply Tubes and Wrenches page 78

¹⁾ Dimension A applies to Clamping Nuts without Sealing Discs. For Clamping Nuts with Sealing Discs see dimension A¹⁾ under Clamping Nuts on pages 62, 63, 64 and 66
²⁾ Only Stop Screw AS-CP16-U (thread M11x1) possible
³⁾ Please refer to page 84 onwards regarding the subject of balancing. The max. rpm is depending on the length and the weight of each chuck.

Collet Chucks with Hollow Tapers

DIN 69893-5 – HSK-E63

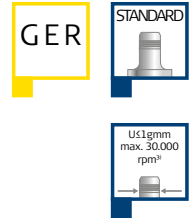
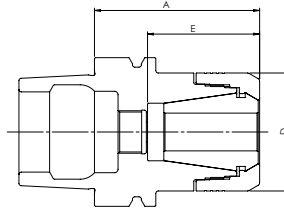

CENTROJP – Version for HPC Clamping Nuts

Description	Order-No.	Form	D	A ¹⁾	max. tool insertion depth without stop	Tool insertion depth with stop				Clamping Range / Collets	Clamping Nuts
						Type U		Type W			
						G max.	G min.	H max.	H min.		
CP32-HSK-E63-A=70 ²⁾	44646000700	E	50	70	47	-	-	-	-	2,0–20,0 GERC32-HP/HPD/GBD	HPC32• HPC32-DI

Accessories: Clamping Nuts pages 64, 66, Wrenches pages 67, 68, Mounting Devices page 68, Precision Collets pages 69 - 71, Tap Collets pages 72, 73, Sealing Discs page 75, Taper Wipers page 77, Coolant Supply Tubes and Wrenches page 78

Collet Chucks with Hollow Tapers

DIN 69893-6 – HSK-F50

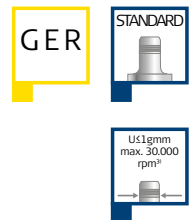
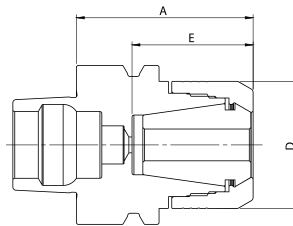

CENTROJP – Version for HPC Clamping Nuts

Description	Order-No.	Form	D	A ¹⁾	max. tool insertion depth without stop	Tool insertion depth with stop				Clamping Range / Collets	Clamping Nuts
						Type U		Type W			
						G max.	G min.	H max.	H min.		
CP25-HSK-F50-A=55 ²⁾	44585000550	F	40	55	38	-	-	-	-	1,0–16,0 GERC25-HP/HPD/GBD	HPC25• HPC25-DI

Accessories: Clamping Nuts pages 64, 66, Wrenches pages 67, 68, Mounting Devices page 68, Precision Collets pages 69 - 71, Tap Collets pages 72, 73, Sealing Discs page 75, Taper Wipers page 77

¹⁾ Dimension A applies to Clamping Nuts without Sealing Discs. For Clamping Nuts with Sealing Discs see dimension A¹⁾ under Clamping Nuts on pages 64 and 66

²⁾ Extra short version, without Stop Screw

³⁾ Please refer to page 84 onwards regarding the subject of balancing. The max. rpm is depending on the length and the weight of each chuck.

Collet Chucks with Hollow Tapers

DIN 69893-6 – HSK-F63

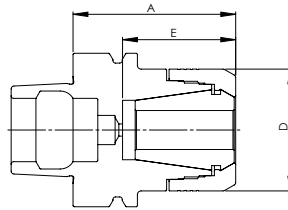

CENTROJP – Version for HPC Clamping Nuts

Description	Order-No.	Form	D	A ¹⁾	max. tool insertion depth without stop	Tool insertion depth with stop				Clamping Range / Collets	Clamping Nuts
						Type U		Type W			
						G max.	G min.	H max.	H min.		
CP16-HSK-F63-A=100	44386001000	F	30	100	70	47	30	33	16	1,0–10,0 GERC16-HP/HPD/GBD	HPC16• HPC16-DI
CP25-HSK-F63-A=100	44586001000		40			52	38	34	20	1,0–16,0 GERC25-HP/HPD/GBD	HPC25• HPC25-DI
CP32-HSK-F63-A=65 ²⁾	44686000650		50	65	39	-	-	-	-	2,0–20,0	HPC32•
CP32-HSK-F63-A=100	44686001000		100	70	54	41	36	22	GERC32-HP/HPD/GBD	HPC32-DI	

Accessories: Clamping Nuts pages 64, 66, Wrenches pages 67, 68, Mounting Devices page 68, Precision Collets pages 69 - 71, Tap Collets pages 72, 73, Sealing Discs page 75, Taper Wipers page 77

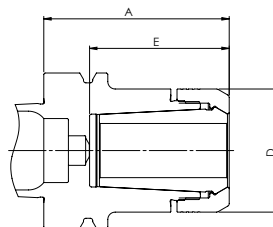

CENTROJP – Version for HPC Clamping Nuts

Description	Order-No.	Form	D	A ¹⁾	max. tool insertion depth without stop	Tool insertion depth with stop				Clamping Range / Collets	Clamping Nuts
						Type U		Type W			
						G max.	G min.	H max.	H min.		
CP225DG-HSK-F63-A=75 ²⁾	48486000750	F	50	75	56	-	-	-	-	2,0–25,0 FM25DG-HP	HPC225• HPC225-DIG

Accessories: Clamping Nuts pages 65, Wrenches pages 67, 68, Mounting Devices page 68, Precision Collets page 74, Sealing Discs page 75, Taper Wipers page 77

¹⁾ Dimension A applies to Clamping Nuts without Sealing Discs. For Clamping Nuts with Sealing Discs see dimension A¹⁾ under Clamping Nuts on pages 64, 65 and 66
²⁾ Extra short version, without Stop Screw
³⁾ Please refer to page 84 onwards regarding the subject of balancing. The max. rpm is depending on the length and the weight of each chuck.

Collet Chucks with Polygonal Shank

ISO 26623-1 - C3 (AD)

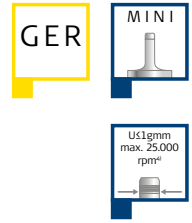
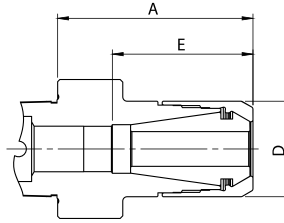

CENTROJP – Slim Version for HPCM Mini Clamping Nuts

Description	Order-No.	Form	D	A ¹⁾	max. tool insertion depth without stop	Tool insertion depth with stop				Clamping Range / Collets	Clamping Nuts
						Type U		Type W			
						E ³⁾	G max.	G min.	H max.		
CP16M-C3-A=45 ²⁾	43353000450	AD	22	45	45	-	-	-	-	1,0-10,0 GERC16-HP/HPD/GBD	HPC16MS• HPC16MS-DI

Accessories: Clamping Nuts pages 62, 63, Wrenches pages 67, 68, Mounting Devices page 68, Precision Collets pages 69 - 71, Tap Collets pages 72, 73, Sealing Discs page 75, Taper Wipers page 77

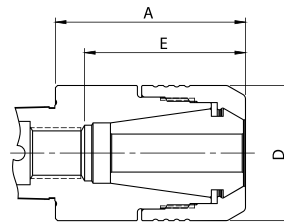

CENTROJP – Version for HPC Clamping Nuts

Description	Order-No.	Form	D	A ¹⁾	max. tool insertion depth without stop	Tool insertion depth with stop				Clamping Range / Collets	Clamping Nuts
						Type U		Type W			
						E ³⁾	G max.	G min.	H max.		
CP20-C3-A=45 ²⁾	44453000450	AD	32	45	36	-	-	-	-	1,0-13,0 GERC20-HP/HPD/GBD	HPC20• HPC20-DI

Accessories: Clamping Nuts pages 64, 66, Wrenches pages 67, 68, Mounting Devices page 68, Precision Collets pages 69 - 71, Tap Collets pages 72, 73, Sealing Discs page 75, Taper Wipers page 77

¹⁾ Dimension A applies to Clamping Nuts without Sealing Discs. For Clamping Nuts with Sealing Discs see dimension A¹⁾ under Clamping Nuts on pages 63, 64 and 66
²⁾ Extra short version, without Stop Screw
³⁾ With the thread M12x1,5 stated by the ISO standard 26613-1, cutting tools with shank diameters up to 10 mm can be inserted deeper in interface C3 as mentioned at dimension E in the chart.
⁴⁾ Please refer to page 84 onwards regarding the subject of balancing. The max. rpm is depending on the length and the weight of each chuck.

Collet Chucks with Polygonal Shank ISO26623-1-C4 (AD)

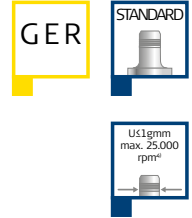
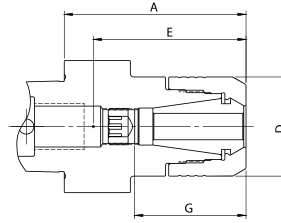

CENTROJP – Version for HPC Clamping Nuts

Description	Order-No.	Form	D	A ¹⁾	max. tool in- sertion depth without stop	Tool insertion depth with stop				Clamping Range / Collets	Clamping Nuts
						Type U		Type W			
						G max.	G min.	H max.	H min.		
CP16-C4-A=55	44354000550	AD	30	55	47	38	29	-	-	1,0–10,0 GERC16-HP/HPD/GBD	HPC16• HPC16-DI
CP20-C4-A=55 ²⁾	44454000550		32		44	-	-	-	-	1,0–13,0 GERC20-HP/HPD/GBD	HPC20• HPC20-DI
CP32-C4-A=54 ²⁾	44654000540		50	54	50	-	-	-	-	2,0–20,0 GERC32-HP/HPD/GBD	HPC32• HPC32-DI

Accessories: Clamping Nuts pages 64, 66, Wrenches pages 67, 68, Mounting Devices page 68, Precision Collets pages 69 - 71, Tap Collets pages 72, 73, Sealing Discs page 75, Stop Screws page 76, Taper Wipers page 77

¹⁾ Dimension A applies to Clamping Nuts without Sealing Discs. For Clamping Nuts with Sealing Discs see dimension A¹⁾ under Clamping Nuts on pages 64 and 66

²⁾ Extra short version, without Stop Screw

³⁾ With the thread M14x1,5 stated by the ISO standard 26613-1, cutting tools with shank diameters up to 12 mm can be inserted deeper in interface C4 as mentioned at dimension E in the chart.

⁴⁾ Please refer to page 84 onwards regarding the subject of balancing. The max. rpm is depending on the length and the weight of each chuck.

Collet Chucks with Polygonal Shank

ISO26623-1 - C5 (AD)

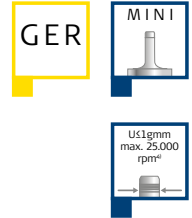
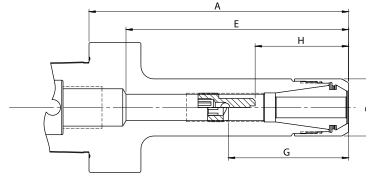

CENTROIP – Slim Version for HPCM Mini Clamping Nuts

Description	Order-No.	Form	D	A ¹⁾	max. tool insertion depth without stop	Tool insertion depth with stop				Clamping Range / Collets	Clamping Nuts
						Type U		Type W			
						E ³⁾	G max.	G min.	H max.		
CP16M-C5-A=100	43355001000	AD	22	100	87	50	30	36	30	1,0–10,0 GERC16-HP/HPD/GBD	HPC16MS• HPC16MS-DI

Accessories: Clamping Nuts pages 62, 63, Wrenches pages 67, 68, Mounting Devices page 68, Precision Collets pages 69 - 71, Tap Collets pages 72, 73, Sealing Discs page 75, Stop Screws page 76, Taper Wipers page 77

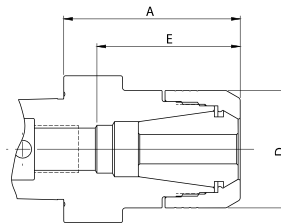

CENTROIP – Version for HPC Clamping Nuts

Description	Order-No.	Form	D	A ¹⁾	max. tool insertion depth without stop	Tool insertion depth with stop				Clamping Range / Collets	Clamping Nuts
						Type U		Type W			
						E ³⁾	G max.	G min.	H max.		
CP16-C5-A=60	44355000600	AD	30	60	47	38	29	-	-	1,0–10,0	HPC16•
CP16-C5-A=100	44355001000			100	87	51		37	29	GERC16-HP/HPD/GBD	HPC16-DI
CP25-C5-A=60 ²⁾	44555000600		60	40	48	-	-	-	-	1,0–16,0 GERC25-HP/HPD/GBD	HPC25• HPC25-DI
CP32-C5-A=60 ²⁾	44655000600			50	49	-	-	-	-	2,0–20,0 GERC32-HP/HPD/GBD	HPC32• HPC32-DI

Accessories: Clamping Nuts pages 64, 66, Wrenches pages 67, 68, Mounting Devices page 68, Precision Collets pages 69 - 71, Tap Collets pages 72, 73, Sealing Discs page 75, Stop Screws page 76, Taper Wipers page 77

¹⁾ Dimension A applies to Clamping Nuts without Sealing Discs. For Clamping Nuts with Sealing Discs see dimension A¹⁾ under Clamping Nuts on pages 63, 64 and 66
²⁾ Extra short version, without Stop Screw
³⁾ With the thread M16x1,5 stated by the ISO standard 26613-1, cutting tools with shank diameters up to 14 mm can be inserted deeper in interface C5 as mentioned at dimension E in the chart.
⁴⁾ Please refer to page 84 onwards regarding the subject of balancing. The max. rpm is depending on the length and the weight of each chuck.

Collet Chucks with Polygonal Shank ISO 26623-1 - C6 (AD)

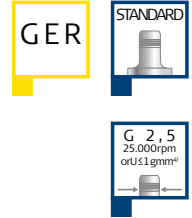
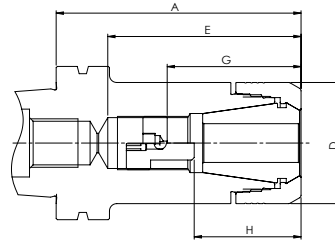

CENTROJP – Version for HPC Clamping Nuts

Description	Order-No.	Form	D	A ¹⁾	max. tool in- sertion depth without stop	Tool insertion depth with stop				Clamping Range / Collets	Clamping Nuts
						Type U		Type W			
						G max.	G min.	H max.	H min.		
CP16-C6-A=60 ²⁾	44356000600	AD	30	60	44	-	-	-	-	1,0-10,0	HPC16• HPC16-DI
CP16-C6-A=100	44356001000			100	83	53	29	39	25	GERC16-HP/HPD/GBD	
CP20-C6-A=60 ²⁾	44456000600		32	60	44	-	-	-	-	1,0-13,0	HPC20• HPC20-DI
CP20-C6-A=100	44456001000			100	84	59	33	-	-	GERC20-HP/HPD/GBD	
CP25-C6-A=60 ²⁾	44556000600		40	60	38	-	-	-	-	1,0-16,0 GERC25-HP/HPD/GBD	HPC25• HPC25-DI
CP25-C6-A=100	44556001000			100	78	62	36	45	30		
CP25-C6-A=130	44556001300			130	99	70	34	50			
CP25-C6-A=160	44556001600			160	118						
CP32-C6-A=60 ²⁾	44656000600		50	60	42	-	-	-	-	2,0-20,0 GERC32-HP/HPD/GBD	HPC32• HPC32-DI
CP32-C6-A=100	44656001000			100	79	63	45	45	25		
CP32-C6-A=130	44656001300			130	99	65	53				
CP40-C6-A=65 ²⁾	44756000650		63	65	51	-	-	-	-	3,0-26,0 GERC40-HP/HPD/GBD	HPC40• HPC40-DI
CP40-C6-A=100	44756001000			100	86	46	50				

Accessories: Clamping Nuts pages 64, 66, Wrenches pages 67, 68, Mounting Devices page 68, Precision Collets pages 69 - 71, Tap Collets pages 72, 73, Sealing Discs page 75, Stop Screws page 76, Taper Wipers page 77

¹⁾ Dimension A applies to Clamping Nuts without Sealing Discs. For Clamping Nuts with Sealing Discs see dimension A¹⁾ under Clamping Nuts on pages 64 and 66
²⁾ Extra short version, without Stop Screw
³⁾ With the thread M20x2 stated by the ISO standard 26613-1, cutting tools with shank diameters up to 18 mm can be inserted deeper in interface C6 as mentioned at dimension E in the chart.
⁴⁾ Please refer to page 84 onwards regarding the subject of balancing. The max. rpm is depending on the length and the weight of each chuck.

Collet Chucks with Polygonal Shank

ISO 26623-1 - C8 (AD)

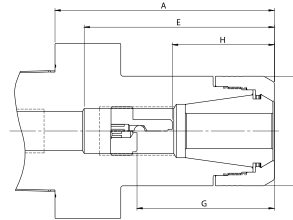

CENTROJP – Version for HPC Clamping Nuts

Description	Order-No.	Form	D	A ¹⁾	max. tool insertion depth without stop	Tool insertion depth with stop				Clamping Range / Collets	Clamping Nuts
						Type U		Type W			
						G max.	G min.	H max.	H min.		
CP25-C8-A=100	44558001000	AD	40	100	86	77	42	62	35	1,0–16,0 GERC25-HP/HPD/GBD	HPC25• HPC25-DI
CP32-C8-A=100	44658001000		50			63	41	45	27	2,0–20,0 GERC32-HP/HPD/GBD	HPC32• HPC32-DI

Accessories: Clamping Nuts pages 64, 66, Wrenches pages 67, 68, Mounting Devices page 68, Precision Collets pages 69 - 71, Tap Collets pages 72, 73, Sealing Discs page 75, Stop Screws page 76, Taper Wipers page 77

¹⁾ Dimension A applies to Clamping Nuts without Sealing Discs. For Clamping Nuts with Sealing Discs see dimension A¹⁾ under Clamping Nuts on pages 64 and 66

²⁾ With the thread M20x2 stated by the ISO standard 26613-1, cutting tools with shank diameters up to 18 mm can be inserted deeper in interface C8 as mentioned at dimension E in the chart.

³⁾ Please refer to page 84 onwards regarding the subject of balancing. The max. rpm is depending on the length and the weight of each chuck.

Collet Chucks with Taper Shanks

JIS B 6339 (DIN ISO 7388-2) – MAS/BT30 (AD)

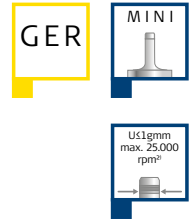
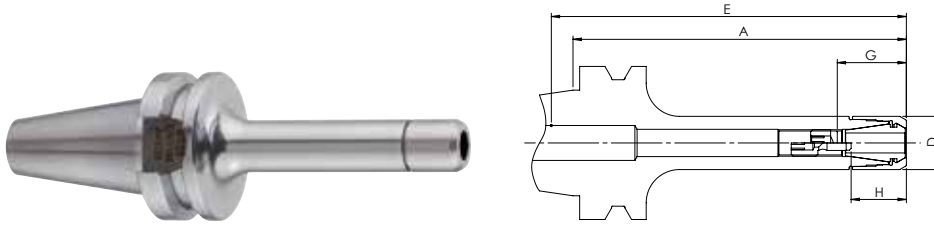

CENTROJP – Slim Version for HPCM Mini Clamping Nuts

Description	Order-No.	Form	D	A ¹⁾	max. tool insertion depth without stop	Tool insertion depth with stop				Clamping Range / Collets	Clamping Nuts
						Type U		Type W			
						G max.	G min.	H max.	H min.		
CP8M-BT30-A=75	43163000750	AD	10	75	75	-	-	-	-	1,0–5,0 GERC8-HP	HPC8M
CP11M-BT30-A=50	43263000500					32	18	22	12		
CP11M-BT30-A=100	43263001000										

Accessories: Clamping Nuts pages 62, 63, Wrenches pages 67, 68, Mounting Devices page 68, Precision Collets pages 69, 70, Stop Screws page 76, Taper Wipers page 77, Pull Studs pages 80, 81

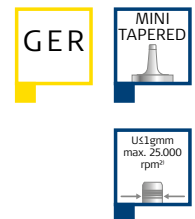
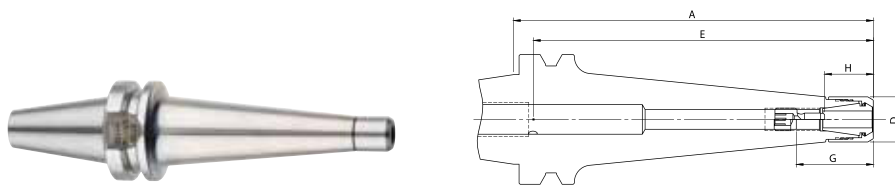

CENTROJP – Tapered Version for HPCM Mini Clamping Nuts

Description	Order-No.	Form	D	A ¹⁾	max. tool insertion depth without stop	Tool insertion depth with stop				Clamping Range / Collets	Clamping Nuts
						Type U		Type W			
						G max.	G min.	H max.	H min.		
CPC11M-BT30-A=130	43263001300	AD	16	130	130	29	19	19	13	1,0–7,0 GERC11-HP/HPD	HPC11M• HPC11M-DI
CPC11M-BT30-A=160	43263001600										

Accessories: Clamping Nuts pages 62, 63, Wrenches pages 67, 68, Mounting Devices page 68, Precision Collets pages 69, 70, Stop Screws page 76, Taper Wipers page 77, Pull Studs pages 80, 81

¹⁾ Dimension A applies to Clamping Nuts without Sealing Discs. For Clamping Nuts with Sealing Discs see dimension A¹⁾ under Clamping Nuts on page 62
²⁾ Please refer to page 84 onwards regarding the subject of balancing. The max. rpm is depending on the length and the weight of each chuck.

Collet Chucks with Taper Shanks

JIS B 6339 (DIN ISO 7388-2) – MAS/BT30 (AD)

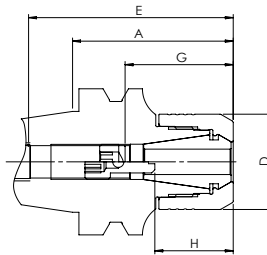

CENTROJP – Version for HPC Clamping Nuts

Description	Order-No.	Form	D	A ¹⁾	max. tool in- sertion depth without stop	Tool insertion depth with stop				Clamping Range / Collets	Clamping Nuts			
						Type U		Type W						
						G max.	G min.	H max.	H min.					
CP16-BT30-A=50	44363000500	AD	30	50	73	44	28	29	31	29	1,0–10,0 GERC16-HP/HPD/GBD	HPC16• HPC16-DI		
CP16-BT30-A=60	44363000600			60	82	41	29						31	29
CP16-BT30-A=75	44363000750			75	97									
CP16-BT30-A=90	44363000900			90	100									
CP16-BT30-A=100	44363001000			100	110	45	29						31	29
CP16-BT30-A=105	44363001050			105	115									
CP16-BT30-A=120	44363001200			120	130									
CP20-BT30-A=60	44463000600		32	32	60	65	44	33	-	-	-	1,0–13,0 GERC20-HP/HPD/GBD	HPC20• HPC20-DI	
CP20-BT30-A=75	44463000750				75	80								
CP20-BT30-A=90	44463000900				90	80								
CP20-BT30-A=105	44463001050				105	95								
CP20-BT30-A=120	44463001200				120	110								
CP25-BT30-A=60	44563000600		40	40	60	77	54	-	35	39	35	1,0–16,0 GERC25-HP/HPD/GBD	HPC25• HPC25-DI	
CP25-BT30-A=75	44563000750				75	87	56	45						
CP25-BT30-A=90	44563000900				90	87	62	41						-
CP25-BT30-A=120	44563001200	120			115									
CP32-BT30-A=60	44663000600	60			69									
CP32-BT30-A=75	44663000750	50	50	75	84	55	41	-	-	-	2,0–20,0 GERC32-HP/HPD/GBD	HPC32• HPC32-DI		
CP32-BT30-A=90	44663000900			90	94	60								
CP32-BT30-A=105	44663001050			105	110									

Accessories: Clamping Nuts pages 64, 66, Wrenches pages 67, 68, Mounting Devices page 68, Precision Collets pages 69 - 71, Tap Collets pages 72, 73, Sealing Discs page 75, Stop Screws page 76, Taper Wipers page 77, Pull Studs pages 80, 81

¹⁾ Dimension A applies to Clamping Nuts without Sealing Discs. For Clamping Nuts with Sealing Discs see dimension A¹⁾ under Clamping Nuts on page 64 and 66
²⁾ Please refer to page 84 onwards regarding the subject of balancing. The max. rpm is depending on the length and the weight of each chuck.

Collet Chucks with Taper Shanks

JIS B 6339 (DIN ISO 7388-2) – MAS/BT40 (AD|AD/B)

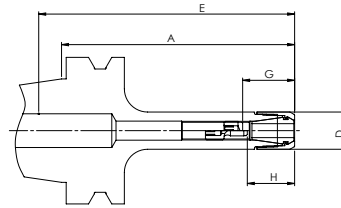

CENTRO|P – Slim Version for HPCM Mini Clamping Nuts

Description	Order-No.	Form	D	A ¹⁾	max. tool insertion depth without stop	Tool insertion depth with stop				Clamping Range / Collets	Clamping Nuts
						Type U		Type W			
						G max.	G min.	H max.	H min.		
CP11M-BTB40-A=75	43264000750	AD/B	16	75	85	30	15	21	8	1,0–7,0 GERC11-HP/HPD	HPC11M• HPC11M-DI
CP11M-BTB40-A=100	43264001000			100	110	36	18	26	12		
CP11M-BTB40-A=120	43264001200			120	130	30	15	21	8		
CP11M-BTB40-A=160	43264001600			160	170	36	18	26	12		
CP16M-BTB40-A=75	43364000750		22	75	100	49	27	32	16	1,0–10,0 GERC16-HP/HPD/GBD	HPC16MS• HPC16MS-DI
CP16M-BTB40-A=90	43364000900			90	115						
CP16M-BTB40-A=120	43364001200			120	145						
CP16M-BTB40-A=150	43364001500			150	175						

Accessories: Clamping Nuts pages 62, 63, Wrenches pages 67, 68, Mounting Devices page 68, Precision Collets pages 69 - 71, Tap Collets pages 72, 73, Sealing Discs page 75, Stop Screws page 76, Taper Wipers page 77, Pull Studs pages 80, 81

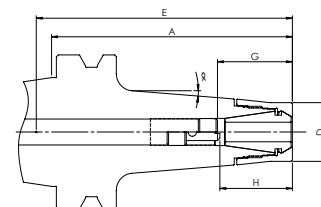

CENTRO|P – Tapered Version for HPCC Special Clamping Nuts

Description	Order-No.	Form	D	A ¹⁾	α	max. tool insertion depth without stop	Tool insertion depth with stop				Clamping Range / Collets	Clamping Nuts
							Type U		Type W			
							G max.	G min.	H max.	H min.		
CPC16-BTB40-A=100	44364401000	AD/B	24	100	4,5	110	48	28	35	20	1,0–10,0 GERC16-HP/ HPD/GBD	HPC16C• HPC16C-DI
CPC16-BTB40-A=160	44364401600			160								

Accessories: Clamping Nuts page 63, Wrenches pages 67, 68, Mounting Devices page 68, Precision Collets pages 69 - 71, Tap Collets pages 72, 73, Sealing Discs page 75, Stop Screws page 76, Taper Wipers page 77, Pull Studs pages 80, 81

¹⁾ Dimension A applies to Clamping Nuts without Sealing Discs. For Clamping Nuts with Sealing Discs see dimension A¹⁾ under Clamping Nuts on pages 62 and 63
²⁾ Please refer to page 84 onwards regarding the subject of balancing. The max. rpm is depending on the length and the weight of each chuck.

Collet Chucks with Taper Shanks

JIS B 6339 (DIN ISO 7388-2) – MAS/BT40 (AD)

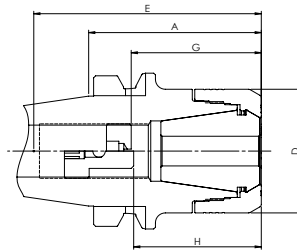

CENTROJP – Version for HPC Clamping Nuts

Description	Order-No.	Form	D	A ¹⁾	max. tool in- sertion depth without stop	Tool insertion depth with stop				Clamping Range / Collets	Clamping Nuts
						Type U		Type W			
						G max.	G min.	H max.	H min.		
CP16-BT40-A=75	44365000750	AD	30	75	110	52	39	38	29	1,0–10,0 GERC16-HP/HPD/GBD	HPC16• HPC16-DI
CP16-BT40-A=90	44365000900			90	125						
CP16-BT40-A=105	44365001050			105	140						
CP16-BT40-A=120	44365001200			120	155						
CP16-BT40-A=150	44365001500			150	170						
CP16-BT40-A=165	44365001650			165	195						
CP16-BT40-A=200	44365002000			200	230						
CP20-BT40-A=75	44465000750		32	75	76	53	40	-	-	1,0–13,0 GERC20-HP/HPD/GBD	HPC20• HPC20-DI
CP20-BT40-A=90	44465000900			90	90						
CP20-BT40-A=105	44465001050			105	105						
CP20-BT40-A=120	44465001200			120	105						
CP20-BT40-A=165	44465001650			165	150						
CP25-BT40-A=60	44565000600		40	60	75	58	41	40	-	1,0–16,0 GERC25-HP/HPD/GBD	HPC25• HPC25-DI
CP25-BT40-A=75	44565000750			75	90						
CP25-BT40-A=90	44565000900			90	100						
CP25-BT40-A=105	44565001050			105	110						
CP25-BT40-A=120	44565001200			120	110						
CP25-BT40-A=150	44565001500			150	120						
CP25-BT40-A=165	44565001650			165	120						
CP25-BT40-A=200	44565002000		200	155							
CP32-BT40-A=60	44665000600		50	60	90	72	41	55	41	2,0–20,0 GERC32-HP/HPD/GBD	HPC32• HPC32-DI
CP32-BT40-A=75	44665000750			75	100						
CP32-BT40-A=90	44665000900			90	110						
CP32-BT40-A=105	44665001050			105	110						
CP32-BT40-A=120	44665001200			120	135						
CP32-BT40-A=150	44665001500			150	135						
CP32-BT40-A=165	44665001650			165	135						
CP40-BT40-A=75	44765000750		63	75	95	58	48	-	-	3,0–26,0 GERC40-HP/HPD/GBD	HPC40• HPC40-DI
CP40-BT40-A=105	44765001050	105		125							

Accessories: Clamping Nuts pages 64, 66, Wrenches pages 67, 68, Mounting Devices page 68, Precision Collets pages 69 - 71, Tap Collets pages 72, 73, Sealing Discs page 75, Stop Screws page 76, Taper Wipers page 77, Pull Studs pages 80, 81

¹⁾ Dimension A applies to Clamping Nuts without Sealing Discs. For Clamping Nuts with Sealing Discs see dimension A¹⁾ under Clamping Nuts on pages 64 and 66
²⁾ Please refer to page 84 onwards regarding the subject of balancing. The max. rpm is depending on the length and the weight of each chuck.

Collet Chucks with Taper Shanks

JIS B 6339 (DIN ISO 7388-2) – MAS/BT40 (AD/B)

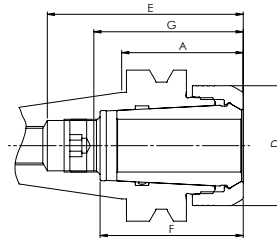

CENTROJP – Version for HPC Clamping Nuts

Description	Order-No.	Form	D	A ¹⁾	max. tool insertion depth without stop		Tool insertion depth with stop				Clamping Range / Collets	Clamping Nuts
					E ²⁾	F ²⁾	Type U		Type W			
							G max.	G min.	H max.	H min.		
CP225DG-BTB40-A=48	48464000480	AD/B	50	48	89	59	62	56	-	-	2,0–25,0 FM25DG-HP	HPC225• HPC225-DIG

Accessories: Clamping Nuts page 65, Wrenches pages 67, 68, Mounting Devices page 68, Precision Collets page 74, Sealing Discs page 75, Stop Screws page 76, Taper Wipers page 77, Pull Studs pages 80, 81

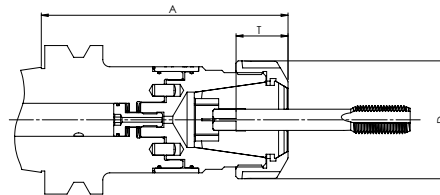

SYNCHROIT

Description	Order-No.	Form	D	A	Tap insertion depth T				Cutting range	Collets
					Shank-ø	Shank-ø	Shank-ø	Shank-ø		
					2,8-7,1	8-9	10-16	18-25		
ST16-GB-BTB40-A=84	52364000840	AD/B	30	84	-	-	-	-	M3–M12	GERC16-GBD
ST25-GB-BTB40-A=89	52564000890		40	89	18	22	-	-	M3–M20	GERC25-GBD
ST32-GB-BTB40-A=110	52664001100		50	110	-	-	-	30	M4–M27	GERC32-GBD

Accessories: Wrenches pages 67, 68, Mounting Devices page 68, Tap Collets pages 72, 73, Taper Wipers page 77, Pull Studs pages 80, 81

¹⁾ Dimension A applies to Clamping Nuts without Sealing Discs. For Clamping Nuts with Sealing Discs see dimension A¹⁾ under Clamping Nuts on page 65

²⁾ Dimension E is for tool shanks ≤ 20 mm and dimension F is for tool shanks > 20 mm

³⁾ Please refer to page 84 onwards regarding the subject of balancing. The max. rpm is depending on the length and the weight of each chuck.

Collet Chucks with Taper Shanks

JIS B 6339(DIN ISO 7388-2) – MAS/BT50 (AD|AD/B)

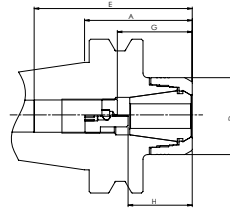

CENTRO|P – Version for HPC Clamping Nuts

Description	Order-No.	Form	D	A ¹⁾	max. tool insertion depth without stop	Tool insertion depth with stop				Clamping Range / Collets	Clamping Nuts
						Type U		Type W			
						G max.	G min.	H max.	H min.		
CP16-BT50-A=105	44367001050	AD	30	105	105	43	29	-	-	1,0–10,0 GERC16-HP/HPD/GBD	HPC16• HPC16-DI
CP16-BT50-A=135	44367001350			135	135						
CP25-BT50-A=105	44567001050		40	105	105	64	39	46	35	1,0–16,0 GERC25-HP/HPD/GBD	HPC25• HPC25-DI
CP25-BT50-A=135	44567001350			135	135						
CP25-BT50-A=165	44567001650			165	165						
CP32-BT50-A=75	44667000750		50	75	100	70	45	52	41	2,0–20,0 GERC32-HP/HPD/GBD	HPC32• HPC32-DI
CP32-BT50-A=105	44667001050			105	110						
CP32-BT50-A=135	44667001350			135	115						
CP32-BT50-A=165	44667001650			165	125						
CP40-BT50-A=75	44767000750		63	75	95	51	47	-	-	3,0–26,0 GERC40-HP/HPD/GBD	HPC40• HPC40-DI
CP40-BT50-A=105	44767001050			105	125						

Accessories: Clamping Nuts pages 64, 66, Wrenches pages 67, 68, Mounting Devices page 68, Precision Collets pages 69 - 71, Tap Collets pages 72, 73, Sealing Discs page 75, Stop Screws page 76, Taper Wipers page 77, Pull Studs pages 80, 81

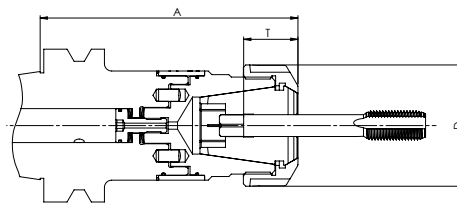

SYNCHRO|T

Description	Order-No.	Form	D	A	Tap insertion depth T				Cutting range	Collets
					Shank-ø 2,8–7,1	Shank-ø 8–9	Shank-ø 10–16	Shank-ø 18–25		
ST32-GB-BTB50-A=120	52666001200	AD/B	50	120	18	22	25	30	M4–M27	GERC32-GBD

Accessories: Wrenches pages 67, 68, Mounting Devices page 68, Tap Collets pages 72, 73, Taper Wipers page 77, Pull Studs pages 80, 81

¹⁾ Dimension A applies to Clamping Nuts without Sealing Discs. For Clamping Nuts with Sealing Discs see dimension A¹⁾ under Clamping Nuts on pages 64 and 66
²⁾ Please refer to page 84 onwards regarding the subject of balancing. The max. rpm is depending on the length and the weight of each chuck.

Collet Chucks with Taper Shanks

JIS B 6339 (DIN ISO 7388-2) – MAS/BTP30 (AD) with Face Contact

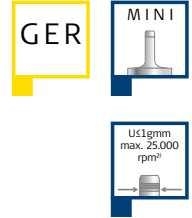
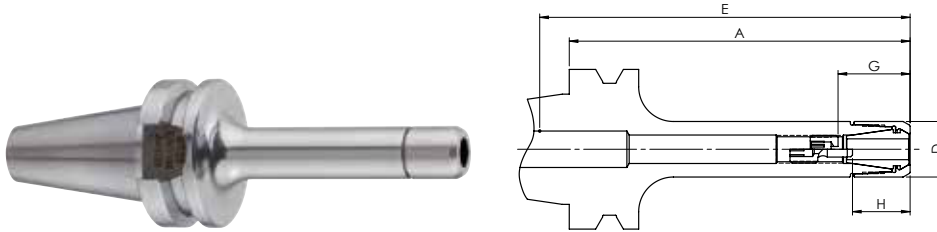

CENTROJP – Version for HPC Clamping Nuts

Description	Order-No.	Form	D	max. tool insertion depth		Tool insertion depth with stop				Clamping Range / Collets	Clamping Nuts
				A ¹⁾	F ²⁾	Type U		Type W			
						E ²⁾	G max.	G min.	H max.		
CP11M-BTP30-A=60	43263360600	AD	16	60	70	32	19	22	19	1,0–7,0 GERC11-HP/HPD	HPC11M• HPC11M-DI
CP11M-BTP30-A=90	43263360900			90	100						
CP11M-BTP30-A=105	43263361050			105	115						

Accessories: Clamping Nuts page 62, Wrenches pages 67, 68, Mounting Devices page 68, Precision Collets pages 69, 70, Stop Screws page 76, Taper Wipers page 77, Pull Studs pages 80, 81

¹⁾ Dimension A applies to Clamping Nuts without Sealing Discs. For Clamping Nuts with Sealing Discs see dimension A¹⁾ under Clamping Nuts on page 62
²⁾ Please refer to page 84 onwards regarding the subject of balancing. The max. rpm is depending on the length and the weight of each chuck.

Collet Chucks with Taper Shanks

JIS B 6339 (DIN ISO 7388-2) – MAS/BTP30 (AD) with Face Contact

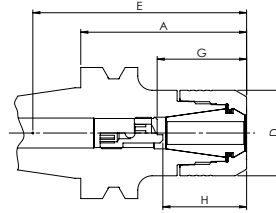

CENTROJP – Version for HPC Clamping Nuts

Description	Order-No.	Form	D	A ¹⁾	max. tool in- sertion depth without stop	Tool insertion depth with stop				Clamping Range / Collets	Clamping Nuts						
						Type U		Type W									
						G max.	G min.	H max.	H min.								
CP16-BTP30-A=60	44363360600	AD	30	60	82	41	29	-	29	1,0–10,0 GERC16-HP/HPD/GBD	HPC16• HPC16-DI						
CP16-BTP30-A=75	44363360750			75	97												
CP16-BTP30-A=90	44363360900			90	100												
CP16-BTP30-A=105	44363361050			105	115												
CP16-BTP30-A=120	44363361200			120	130												
CP20-BTP30-A=60	44463360600			32	60	65						44	33	-	-	1,0–13,0 GERC20-HP/HPD/GBD	HPC20• HPC20-DI
CP20-BTP30-A=75	44463360750		75		80												
CP20-BTP30-A=90	44463360900		90		80												
CP20-BTP30-A=105	44463361050		105		95												
CP20-BTP30-A=120	44463361200		120		110												
CP25-BTP30-A=60	44563360600		40		60	77	54	35	-	39	35						
CP25-BTP30-A=75	44563360750			75	87	56											
CP25-BTP30-A=90	44563360900	90		87	62												
CP25-BTP30-A=120	44563361200	120		115	62												
CP32-BTP30-A=60	44663360600	50		60	69	45	41					-	-	2,0–20,0 GERC32-HP/HPD/GBD	HPC32• HPC32-DI		
CP32-BTP30-A=75	44663360750			75	84	55											
CP32-BTP30-A=90	44663360900		90	94	60												
CP32-BTP30-A=105	44663361050		105	110	60												

Accessories: Clamping Nuts pages 64, 66, Wrenches pages 67, 68, Mounting Devices page 68, Precision Collets pages 69 - 71, Tap Collets pages 72, 73, Sealing Discs page 75, Stop Screws page 76, Taper Wipers page 77, Pull Studs pages 80, 81

¹⁾ Dimension A applies to Clamping Nuts without Sealing Discs. For Clamping Nuts with Sealing Discs see dimension A¹⁾ under Clamping Nuts on page 64 and 66
²⁾ Please refer to page 84 onwards regarding the subject of balancing. The max. rpm is depending on the length and the weight of each chuck.

Collet Chucks with Taper Shanks

JIS B 6339 – MAS/BTP40 (AD) with Face Contact

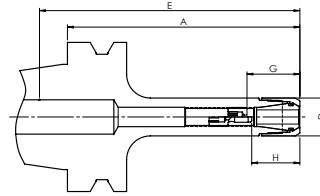

CENTROJP – Version for HPC Clamping Nuts

Description	Order-No.	Form	D	A ¹⁾		max. tool insertion depth without stop		Tool insertion depth with stop				Clamping Range / Collets	Clamping Nuts	
				E ²⁾	F ²⁾	Type U		Type W						
						G max.	G min.	H max.	H min.					
CP11M-BTP40-A=90	43265360900	AD	16	90	100	35	19	25	19	1,0-7,0 GERC11-HP/HPD	HPC11M• HPC11M-DI			
CP11M-BTP40-A=105	43265361050			105	115									
CP11M-BTP40-A=120	43265361200			120	130									
CP11M-BTP40-A=165	43265361650			165	175									
CP16M-BTP40-A=90	43365360900			22	90	145	49	29	31			29	1,0-10,0 GERC16-HP/HPD/GBD	HPC16MS• HPC16MS-DI
CP16M-BTP40-A=120	43365361200				120	175								

Accessories: Clamping Nuts pages 62, 63, Wrenches pages 67, 68, Mounting Devices page 68, Precision Collets pages 69 - 71, Stop Screws page 76, Taper Wipers page 77, Pull Studs pages 80, 81

¹⁾ Dimension A applies to Clamping Nuts without Sealing Discs. For Clamping Nuts with Sealing Discs see dimension A¹⁾ under Clamping Nuts on pages 62 and 63
²⁾ Please refer to page 84 onwards regarding the subject of balancing. The max. rpm is depending on the length and the weight of each chuck.

Collet Chucks with Taper Shanks

JIS B 6339 (DIN ISO 7388-2) – MAS/BTP40 (AD) with Face Contact

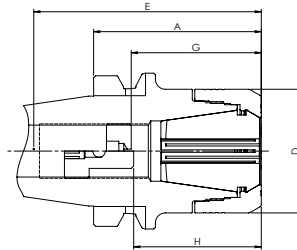

CENTROJP – Version for HPC Clamping Nuts

Description	Order-No.	Form	D	A ¹⁾	max. tool insertion depth without stop	Tool insertion depth with stop				Clamping Range / Collets	Clamping Nuts
						Type U		Type W			
						G max.	G min.	H max.	H min.		
CP16-BTP40-A=75	44365360750	AD	30	75	110	52	39	38	29	1,0–10,0 GERC16-HP/HPD/GBD	HPC16• HPC16-DI
CP16-BTP40-A=90	44365360900			90	125						
CP16-BTP40-A=105	44365361050			105	140						
CP16-BTP40-A=120	44365361200			120	155						
CP16-BTP40-A=150	44365361500			150	170						
CP16-BTP40-A=165	44365361650			165	195						
CP16-BTP40-A=200	44365362000			200	230						
CP20-BTP40-A=75	44465360750			32	75						
CP20-BTP40-A=90	44465360900		90		90						
CP20-BTP40-A=105	44465361050		105		105						
CP20-BTP40-A=120	44465361200		120		105						
CP20-BTP40-A=165	44465361650		165		150						
CP25-BTP40-A=60	44565360600		40	60	75	58	41	40	36	1,0–16,0 GERC25-HP/HPD/GBD	HPC25• HPC25-DI
CP25-BTP40-A=75	44565360750			75	90						
CP25-BTP40-A=90	44565360900			90	100						
CP25-BTP40-A=105	44565361050			105	110						
CP25-BTP40-A=120	44565361200			120	120						
CP25-BTP40-A=150	44565361500			150	120						
CP25-BTP40-A=165	44565361650			165	160						
CP25-BTP40-A=200	44565362000			200	160						
CP32-BTP40-A=60	44665360600		50	60	90	72	41	55	41	2,0–20,0 GERC32-HP/HPD/GBD	HPC32• HPC32-DI
CP32-BTP40-A=75	44665360750			75	100						
CP32-BTP40-A=90	44665360900			90	110						
CP32-BTP40-A=105	44665361050			105	110						
CP32-BTP40-A=120	44665361200			120	110						
CP32-BTP40-A=150	44665361500			150	135						
CP32-BTP40-A=165	44665361650			165	135						

Accessories: Clamping Nuts pages 64, 66, Wrenches pages 67, 68, Mounting Devices page 68, Precision Collets pages 69 - 71, Tap Collets pages 72, 73, Sealing Discs page 75, Stop Screws page 76, Taper Wipers page 77, Pull Studs pages 80, 81

¹⁾ Dimension A applies to Clamping Nuts without Sealing Discs. For Clamping Nuts with Sealing Discs see dimension A¹⁾ under Clamping Nuts on pages 64 and 66
²⁾ Please refer to page 84 onwards regarding the subject of balancing. The max. rpm is depending on the length and the weight of each chuck.

Collet Chucks with Taper Shanks

ANSI B.50 – CAT40 (AD/B)

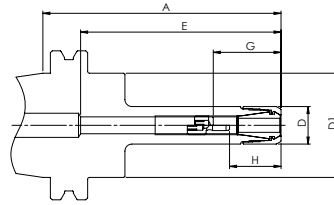

CENTRO|P – Slim Version for HPCM Mini Clamping Nuts

Description	Order-No.	Form	D	D1	A ¹⁾	max. tool insertion depth without stop	Tool insertion depth with stop				Clamping Range / Collets	Clamping Nuts
							Type U		Type W			
							G max.	G min.	H max.	H min.		
CP11M-CAT40-A=4 ²⁾	43275001016	AD/B	16	44,45	4"	130	43	19	32	10	1,0–7,0 GERC11-HP/ HPD	HPC11M• HPC11M-DI
CP11M-CAT40-A=5 ²⁾	43275001270				5"	150						

Accessories: Clamping Nuts pages 62, 63, Wrenches pages 67, 68, Mounting Devices page 68, Precision Collets pages 69, 70, Stop Screws page 76, Taper Wipers page 77

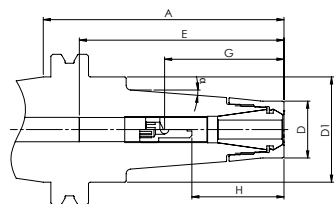

CENTRO|P – Tapered Version for HPCC Special Clamping Nuts

Description	Order-No.	Form	D	D1	A ¹⁾	α	max. tool insertion depth without stop	Tool insertion depth with stop				Clamping Range / Collets	Clamping Nuts
								Type U		Type W			
								G max.	G min.	H max.	H min.		
CPC16-CAT40-A=4 ²⁾	44375401016	AD/B	24	44,45	4"	4,5	125	56	29	42	18	1,0–10,0 GERC16-HP/ HPD/GBD	HPC16C• HPC16C-DI
CPC16-CAT40-A=6 ²⁾	44375401524				6"	2,5	175	66		47			

Accessories: Clamping Nuts page 63, Wrenches pages 67, 68, Mounting Devices page 68, Precision Collets pages 69 – 71, Tap Collets pages 72, 73, Sealing Discs page 75, Stop Screws page 76, Taper Wipers page 77

¹⁾ Dimension A applies to Clamping Nuts without Sealing Discs. For Clamping Nuts with Sealing Discs see dimension A¹⁾ under Clamping Nuts on pages 62 and 63
²⁾ CAT40 is supplied with thread 5/8"-11 UNC complying with ANSI B5.50
³⁾ Please refer to page 84 onwards regarding the subject of balancing. The max. rpm is depending on the length and the weight of each chuck.

Collet Chucks with Taper Shanks

ANSI B.50 – CAT40 (AD/B)

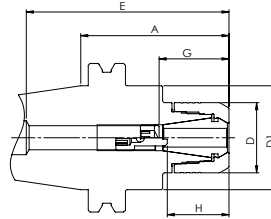

CENTROJP – Version for HPC Clamping Nuts

Description	Order-No.	Form	D	D1	A ¹⁾	max. tool insertion depth without stop	Tool insertion depth with stop				Clamping Range / Collets	Clamping Nuts					
							Type U		Type W								
							E	G max.	G min.	H max.			H min.				
CP16-CAT40-A=2,5'' ²⁾	44375000635	AD/B	30	44,45	2,5''	75	45	28	32	16	1,0–10,0 GERC16-HP/ HPD/GBD	HPC16• HPC16-DI					
CP16-CAT40-A=4'' ²⁾	44375001016				4''	125											
CP16-CAT40-A=5'' ²⁾	44375001270				5''	150											
CP20-CAT40-A=3'' ²⁾	44475000762		32		3''	63	33	-	-	1,0–13,0 GERC20-HP/ HPD/GBD	HPC20• HPC20DI						
CP20-CAT40-A=4'' ²⁾	44475001016				4''	63											
CP25-CAT40-A=3'' ²⁾	44575000762		40		44,45	3''	80	58	35	45	35	1,0–16,0 GERC25-HP/ HPD/GBD	HPC25• HPC25-DI				
CP25-CAT40-A=4'' ²⁾	44575001016					4''	85							65	26		
CP32-CAT40-A=3'' ²⁾	44675000762		50		44,45	3''	94	62	75	58	44	2,0–20,0 GERC32-HP/ HPD/GBD	HPC32• HPC32-DI				
CP32-CAT40-A=4'' ²⁾	44675001016					4''								65	41	48	27
CP32-CAT40-A=5'' ²⁾	44675001270					5''								51	75	58	26
CP32-CAT40-A=6'' ²⁾	44675001524					6''								65	41	48	27
CP40-CAT40-A=4'' ²⁾	44775001016		63		4''	74	-	-	-	-	3,0–26,0 GERC40-HP/ HPD/GBD	HPC40• HPC40-DI					

Accessories: Clamping Nuts pages 64, 66, Wrenches pages 67, 68, Mounting Devices page 68, Precision Collets pages 69 - 71, Tap Collets pages 72, 73, Sealing Discs page 75, Stop Screws page 76, Taper Wipers page 77

¹⁾ Dimension A applies to Clamping Nuts without Sealing Discs. For Clamping Nuts with Sealing Discs see dimension A¹⁾ under Clamping Nuts on pages 64 and 66

²⁾ CAT40 is supplied with thread 5/8"-11 UNC complying with ANSI B5.50

³⁾ Please refer to page 84 onwards regarding the subject of balancing. The max. rpm is depending on the length and the weight of each chuck.

Collet Chucks with Taper Shanks

ANSI B.50 – CAT50 (AD/B)

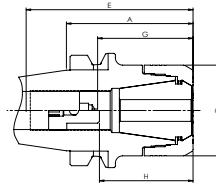

CENTROJP – Version for HPC Clamping Nuts

Description	Order-No.	Form	D	D1	A ¹⁾	max. tool insertion depth without stop	Tool insertion depth with stop				Clamping Range / Collets	Clamping Nuts
							Type U		Type W			
							E	G max.	G min.	H max.		
CP16-CAT50-A=4 ²⁾	44377001016	AD/B	30	69,85	4"	125	57	30	43	19	1,0–10,0 GERC16-HP/ HPD/GBD	HPC16• HPC16-DI
CP16-CAT50-A=6 ²⁾	44377001524				6"	175						
CP20-CAT50-A=4 ²⁾	44477001016		32		4"	87	65	36	46	25	1,0–13,0 GERC20-HP/ HPD/GBD	HPC20• HPC20-DI
CP20-CAT50-A=6 ²⁾	44477001524				6"	115						
CP25-CAT50-A=4 ²⁾	44577001016		40		63	4"	85	41	47	27	2,0–20,0 GERC32-HP/ HPD/GBD	HPC32• HPC32-DI
CP25-CAT50-A=6 ²⁾	44577001524					6"	115					
CP32-CAT50-A=4 ²⁾	44677001016		50		63	4"	95	57	47	-	3,0–26,0 GERC40-HP/ HPD/GBD	HPC40• HPC40-DI
CP32-CAT50-A=6 ²⁾	44677001524					6"	120					
CP40-CAT50-A=4 ²⁾	44777001016		63		63	4"	95	67	-	-	-	-
CP40-CAT50-A=6 ²⁾	44777001524					6"	120					

Accessories: Clamping Nuts pages 64, 66, Wrenches pages 67, 68, Mounting Devices page 68, Precision Collets pages 69 - 71, Tap Collets pages 72, 73, Sealing Discs page 75, Stop Screws page 76, Taper Wipers page 77

¹⁾ Dimension A applies to Clamping Nuts without Sealing Discs. For Clamping Nuts with Sealing Discs see dimension A¹⁾ under Clamping Nuts on pages 64 and 66

²⁾ CAT50 is supplied with thread 1"-8 UNC complying with ANSI B5.50

³⁾ Please refer to page 84 onwards regarding the subject of balancing. The max. rpm is depending on the length and the weight of each chuck.

Collet Chucks with Cylindrical Shank (AD)

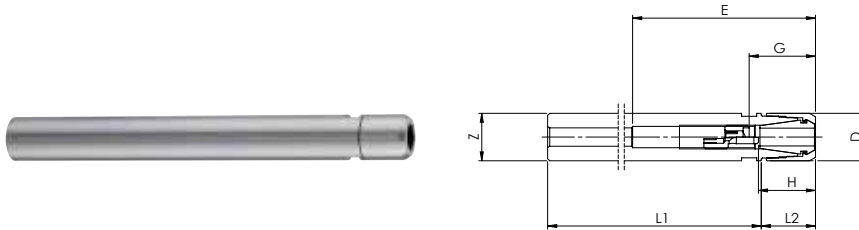

CENTROJP – Tool Extension for HPCM Mini Clamping Nuts

Description	Order-No.	Z	D	L1	L2 ¹⁾	max. tool insertion depth without stop E	Tool insertion depth with stop				Clamping Range / Collets	Clamping Nuts
							Type U		Type W			
							G max.	G min.	H max.	H min.		
CP8M-Z10-L=150	42110001500	10	10	138	12	16	-	-	-	-	1,0-5,0 GERC8-HP	HPC8M
CP8M-Z10-L=200	42110002000			188								
CP11M-Z16-L=150	42216001500	16	16	133	17	68	36	18	26	12	1,0-7,0 GERC11-HP/ HPD	HPC11M• HPC11M-DI
CP11M-Z16-L=200	42216002000			183								
CP16M-Z16-L=150	42316001500			20								
CP16M-Z20-L=150	42320001500	167										
CP16M-Z20-L=200	42320002000	167										

Accessories: Clamping Nuts pages 62, 63, Wrenches pages 67, 68, Precision Collets pages 69 - 71, Tap Collets pages 72, 73, Sealing Discs page 75, Stop Screws page 76, Taper Wipers page 77

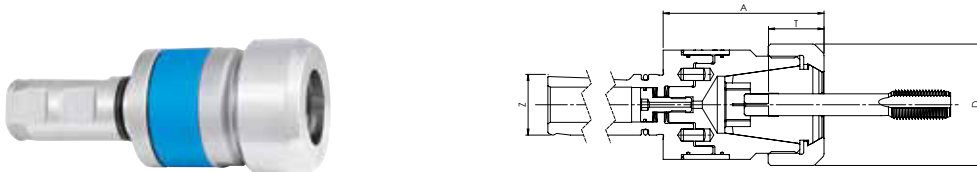

SYNCHROIT – with Shank DIN 1835 B+E

Description	Order-No.	Z	D	A	Tap insertion depth T				Cutting range	Collets
					Shank-ø 2,8-7,1	Shank-ø 8-9	Shank-ø 10-16	Shank-ø 18-25		
ST16-GB-Z20-A=58	52304000580	20	30	58	18	22	25	-	M3-M12	GERC16-GBD
ST16-GB-Z25-A=58	52305000580	25		59						
ST20-GB-Z20-A=59	52404000590	20	32	59	18	22	25	-	M3-M16	GERC20-GBD
ST20-GB-Z25-A=61	52405000610	25		61						
ST25-GB-Z20-A=63	52504000630	20	40	63	18	22	25	-	M3-M20	GERC25-GBD
ST25-GB-Z25-A=65	52505000650	25		65						
ST32-GB-Z25-A=69	52605000690	25	50	69	18	22	25	30	M4-M27	GERC32-GBD
ST32-GB-Z25-A=87	52605000870	25		87						
ST40-GB-Z25-A=109	52705001090	25	63	109	18	22	25	33	M4-M33	GERC40-GBD
ST40-GB-Z32-A=109	52706001090	32		109						

Accessories: Wrenches pages 67, 68, Tap Collets pages 72, 73, Taper Wipers page 77

¹⁾ L2 applies to Clamping Nuts without Sealing Discs, for Clamping Nuts with Sealing Discs see dimension A¹⁾ under Clamping Nuts on pages 62 and 63

Collet Chucks with Taper Shanks similar DIN 69871 – A30 (Wood Working)

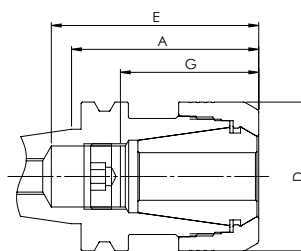

CENTROJP – Version for HPC Clamping Nuts (without driving and positioning slot)

Description	Order-No.	Form	D	A ¹⁾	max. tool insertion depth without stop		Tool insertion depth with stop				Clamping Range / Collets	Clamping Nuts
					E	G	Type U		Type W			
							G max.	G min.	H max.	H min.		
CP32-A30H-A=50	44613000500	A	50	50	66	52	40	-	-	2,0–20,0	HPC32• HPC32-DI	
CP32-A30H-A=70	44613000701			70	76							

Accessories: Clamping Nuts pages 64, 66, Wrenches pages 67, 68, Mounting Devices page 68, Precision Collets pages 69 - 71, Tap Collets pages 72, 73, Sealing Discs page 75, Stop Screws page 76, Taper Wipers page 77

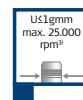
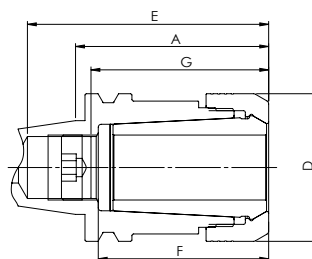

CENTROJP – Version for HPC Clamping Nuts

Description	Order-No.	Form	D	A ¹⁾	max. tool insertion depth without stop		Tool insertion depth with stop				Clamping Range / Collets	Clamping Nuts
					E ²⁾	F ²⁾	Type U		Type W			
							G max.	G min.	H max.	H min.		
CP225DG-A30-A=70	48413000700	A	50	70	81	57	61	53	-	-	2,0–25,0	HPC225• HPC225-DIG

Accessories: Clamping Nuts page 65, Wrenches pages 67, 68, Mounting Devices page 68, Precision Collets page 74, Sealing Discs page 75, Stop Screws page 76, Taper Wipers page 77

¹⁾ Dimension A applies to Clamping Nuts without Sealing Discs. For Clamping Nuts with Sealing Discs see dimension A¹⁾ under Clamping Nuts on pages 64, 65 and 66
²⁾ Dimension E is for tool shanks ≤ 20 mm and dimension F is for tool shanks > 20 mm
³⁾ Please refer to page 84 onwards regarding the subject of balancing. The max. rpm is depending on the length and the weight of each chuck.

Accessories Clamping Nuts HPC

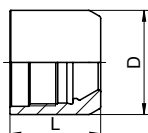

Mini Clamping Nuts HPCM

Description	Order-No.	Clamping Range	D	L	for Collet Chucks	for Collets
HPC8M	4381000	1,0 – 5,0	10	12	CP8M	GERC8-HP
HPC11M	4381100	1,0 – 7,0	16	16,2	CP11M•CPC11M	GERC11-HP/HPD
HPC16MS	43812000010	1,0 – 10,0	22	20,9	CP16M•CPC16M	GERC16-HP/HPD/GBD

- = with extremely small dimensions and for high speeds
- = only the nominal diameter can be clamped

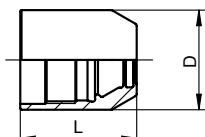

Mini Clamping Nuts HPCM-DI – sealed

Description	Order-No.	Clamping Diameter	D	L	A ¹⁾	for Collet Chucks	for Collets
HPC11M-DI Ø=3,0	43821010300	3,0	16	18,7	+2,5	CP11M•CPC11M	GERC11-HP
HPC11M-DI Ø=4,0	43821010400	4,0					
HPC11M-DI Ø=5,0	43821010500	5,0					
HPC11M-DI Ø=6,0	43821010600	6,0					
HPC11M-DI Ø=7,0	43821010700	7,0					

- = with extremely small dimensions and for high speeds
- = for direct sealing (for internal coolant supply or for sealing against any ingress of dirt)
- = depending on tool shank Ø a Clamping Nut is required
- = only the nominal diameter can be clamped

Due to their design DI Clamping Nuts are longer than standard Clamping Nuts (A-dimension see product pages 18 to 61 plus A¹⁾)



Collet Extractor AZ-ER for Mini Clamping Nuts HPCM

Description	Order-No.	for Clamping Nut	for Collets
AZ-ER8	4499000	HPC8M	GERC8-HP
AZ-ER11	4499100	HPC11M•HPC11M-DI	GERC11-HP/HPD

- = for extraction of the Collet out of the Clamping Nut

Accessories Clamping Nuts HPC

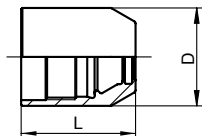

Mini Clamping Nuts HPCM-DI for Sealing Discs

Description	Order-No.	Clamping Range	D	L	A ¹⁾	for Collet Chucks	for Collets
HPC16MS-DI	43822000010	1,0 – 10,0	22	23,9	+3	CP16M•CPC16M	GERC16-HP

- = with extremely small dimensions and for high speeds
- = for Sealing Discs (for internal coolant supply or for sealing against any ingress of dirt)
- = only the nominal diameter can be clamped

Due to their design DI Clamping Nuts are longer than standard Clamping Nuts (A-dimension see product pages 18 to 61 plus A¹⁾)

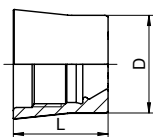

Special Clamping Nuts HPCC (tapered)

Description	Order-No.	Clamping Range	D	L	for Collet Chucks	for Collets
HPC16C	4483200	1,0 – 10,0	24	23,2	CPC16	GERC16-HP/HPD/GBD

- = tapered Clamping Nuts for mould-making industry
- = only the nominal diameter can be clamped

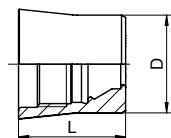

Special Clamping Nuts HPCC-DI (tapered) for Sealing Discs

Description	Order-No.	Clamping Range	D	L	A ¹⁾	for Collet Chucks	for Collets
HPC16C-DI	4484200	1,0 – 10,0	24	26,2	+3	CPC16	GERC16-HP

- = tapered Clamping Nuts for mould-making industry
- = for Sealing Discs (for internal coolant supply or for sealing against any ingress of dirt)
- = only the nominal diameter can be clamped

Due to their design DI Clamping Nuts are longer than standard Clamping Nuts (A-dimension see product pages 18 to 61 plus A¹⁾)

Accessories Clamping Nuts HPC

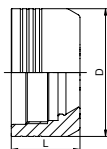

GER

Clamping Nuts HPC

Description	Order-No.	Clamping Range	D	L	for Collet Chucks	for Collets
HPC16	4481200	1,0 – 10,0	30	23,4	CP16	GERC16-HP/HPD/GBD
HPC20	4481300	1,0 – 13,0	32	24,6	CP20	GERC20-HP/HPD/GBD
HPC25	4481400	1,0 – 16,0	40	25,6	CP25	GERC25-HP/HPD/GBD
HPC32	4481500	2,0 – 20,0	50	26,9	CP32	GERC32-HP/HPD/GBD
HPC40	4481600	3,0 – 26,0	63	31,5	CP40	GERC40-HP/HPD/GBD

- = for high speeds
- = for very precise clamping of HPC tools
- = only the nominal diameter can be clamped

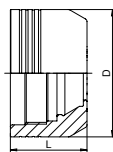

GER

Clamping Nuts HPC-DI for Sealing Discs

Description	Order-No.	Clamping Range	D	L	A ¹⁾	for Collet Chucks	for Collets
HPC16-DI	4482200	1,0 – 10,0	30	26,4	+3	CP16	GERC16-HP
HPC20-DI	4482300	1,0 – 13,0	32	27,6	+3	CP20	GERC20-HP
HPC25-DI	4482400	1,0 – 16,0	40	28,9	+3,3	CP25	GERC25-HP
HPC32-DI	4482500	2,0 – 20,0	50	30,1	+3,2	CP32	GERC32-HP
HPC40-DI	4482600	3,0 – 26,0	63	34,8	+3,3	CP40	GERC40-HP

- = for high speeds
- = for very precise clamping of HPC tools
- = for Sealing Discs (for internal coolant supply or for sealing against any ingress of dirt)
- = only the nominal diameter can be clamped

Due to their design DI Clamping Nuts are longer than standard Clamping Nuts (A-dimension see product pages 18 to 61 plus A¹⁾)

Accessories Clamping Nuts HPC

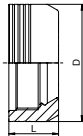

GOZ

Clamping Nuts HPC

Description	Order-No.	Clamping Range	D	L	for Collet Chucks	for Collets
HPC225	4881500	2,0 – 25,0	50	21,2	CP225DG	FM25DG•HP
HPC432	4881700	4,0 – 32,0	63	28	CP432DG	FM32DG

- = for high speeds
- = for very precise clamping of HPC tools
- = only the nominal diameter can be clamped

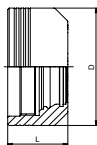

GOZ

Clamping Nuts HPC-DIG for Sealing Discs

Description	Order-No.	Clamping Range	D	L	A ¹⁾	for Collet Chucks	for Collets
HPC225-DIG	4882400	2,0 – 25,0	50	25,2	+4	CP225DG	FM25DG•HP
HPC432-DIG	4882700	4,0 – 32,0	63	32	+4	CP432DG	FM32DG

- = for high speeds
- = for very precise clamping of HPC tools
- = for Sealing Discs (for internal coolant supply or for sealing against any ingress of dirt)
- = only the nominal diameter can be clamped

Due to their design DI Clamping Nuts are longer than standard Clamping Nuts (A-dimension see product pages 18 to 61 plus A¹⁾)

Accessories Clamping Nuts HSS

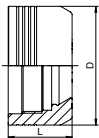

Clamping Nuts HSS

Description	Order-No.	Clamping Range	D	L	for Collet Chucks	for Collets
CP16-HSS-Ø-0,4	4185200	1,0 – 10,0	30	21,3	CP16	GERC16-HP
CP20-HSS-Ø-0,4	4185300	1,0 – 13,0	32	22,8	CP20	GERC20-HP
CP25-HSS-Ø-0,4	4185400	1,0 – 16,0	40	23,8	CP25	GERC25-HP
CP32-HSS-Ø-0,4	4185500	2,0 – 20,0	50	24,9	CP32	GERC32-HP

- = for clamping HSS tools
- = limited speed (pre-balanced)
- = with collapse (minus 0,4 mm)

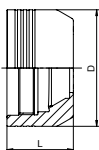

Clamping Nuts HSS-DI for Sealing Discs

Description	Order-No.	Clamping Range	D	L	A ¹⁾	for Collet Chucks	for Collets
CP16-HSS-DI-Ø-0,4	4186200	1,0 – 10,0	30	24,8	+2,5	CP16	GERC16-HP
CP20-HSS-DI-Ø-0,4	4186300	1,0 – 13,0	32	25,9	+3,1	CP20	GERC20-HP
CP25-HSS-DI-Ø-0,4	4186400	1,0 – 16,0	40	26,8	+3	CP25	GERC25-HP
CP32-HSS-DI-Ø-0,4	4186500	2,0 – 20,0	50	28,2	+3,3	CP32	GERC32-HP

- = for clamping HSS tools
- = limited speed (pre-balanced)
- = for Sealing Discs (for internal coolant supply or for sealing against any ingress of dirt)
- = with collapse (minus 0,4 mm)

Due to their design DI Clamping Nuts are longer than standard Clamping Nuts (A-dimension see product pages 18 to 61 plus A¹⁾)

Accessories Wrenches RO | DRO



Ingeniously simple, simply ingenious!

Our Roller Bearing Wrenches are designed for safe, quick and simple clamping of tools without any risk of injury to the user, because they cannot slip off the clamping nuts. They are available in two versions:

with standard handle or with square drive adapter for defined clamping of tools using a torque wrench.

Our Roller Bearing Wrenches are suitable for:

- = all CENTROIP Clamping Nuts and all Clamping Nuts complying with DIN ISO15488 (ER/ESX) with external diameters 10/16/22/24/30/32/35/40/42/50 and 63mm
- = all Clamping Nuts without grooves and drilling, which is more positive at high speeds because of improved weight properties and quiet running.

Roller Bearing Wrenches RO with Handle

Description	Order-No.	for Clamping Nuts
ROD10N	4996300	HPC8M
RO16	4990400	HPC11M•HPC11M-DI
RO22	4990500	HPC16MS•HPC16MS-DI
RO24	4990600	HPC16M•HPC16M-DI•HPC16C•HPC16C-DI
RO30	4990900	HPC16•HPC16-DI•CP16-HSS-Ø-0,4•CP16-HSS-DI-Ø-0,4•ST16-GB
RO32	4991100	HPC20•HPC20-DI•CP20-HSS-Ø-0,4•CP20-HSS-DI-Ø-0,4•ST20-GB
RO40	4991400	HPC25•HPC25-DI•CP25-HSS-Ø-0,4•CP25-HSS-DI-Ø-0,4•ST25-GB
RO50	4991800	HPC32•HPC32-DI•CP32-HSS-Ø-0,4•CP32-HSS-DI-Ø-0,4•ST32-GB•HPC225•HPC225-DIG
RO63	4992000	HPC40•HPC40-DI•CP40-HSS-Ø-0,4•CP40-HSS-DI-Ø-0,4•ST40-GB•HPC432•HPC432-DIG



Roller Bearing Heads DRO

Description	Order-No.	VKT	for Clamping Nuts
DRO16	4993400		HPC11M•HPC11M-DI
DRO22	4993500	9x12	HPC16MS•HPC16MS-DI
DRO24	4993600		HPC16M•HPC16M-DI•HPC16C•HPC16C-DI
DRO30	4993900		HPC16•HPC16-DI•CP16-HSS-Ø-0,4•CP16-HSS-DI-Ø-0,4•ST16-GB
DRO32	4994100		HPC20•HPC20-DI•CP20-HSS-Ø-0,4•CP20-HSS-DI-Ø-0,4•ST20-GB
DRO40	4994400		HPC25•HPC25-DI•CP25-HSS-Ø-0,4•CP25-HSS-DI-Ø-0,4•ST25-GB
DRO50	4994800	14x18	HPC32•HPC32-DI•CP32-HSS-Ø-0,4•CP32-HSS-DI-Ø-0,4•ST32-GB•HPC225•HPC225-DIG
DRO63	4995000		HPC40•HPC40-DI•CP40-HSS-Ø-0,4•CP40-HSS-DI-Ø-0,4•ST40-GB•HPC432•HPC432-DIG



Accessories Wrenches DRMO | DRTW



Torque Setting Wrenches DRMO

Description	Order-No.	VKT	Torque range	for Roller Bearing Head
DRMO-5-25	4900000	9x12	5 - 25 Nm	DRO16•DRO22
DRMO-10-50	4900200	9x12	10 - 50 Nm	DRO16•DRO22•DRO24
DRMO-20-100	4900400	9x12	20 - 100 Nm	DRO24•DRO30•DRO32•DRO35
DRMO-40-200	4900600	14x18	40 - 200 Nm	DRO40•DRO42•DRO50•DRO63
DRMO-60-300	4900800	14x18	60 - 300 Nm	DRO63 (for CP432DG)



Torque Setting Wrenches DRTW

Description	Order-No.	VKT	Torque range	for Roller Bearing Head
DRTW-5-30	4901200	9x12	5 - 30 Nm	DRO16•DRO22
DRTW-10-80	4901400	9x12	10 - 80 Nm	DRO22•DRO24•DRO30•DRO32•DRO35
DRTW-10-80	4901500	14x18	10 - 80 Nm	
DRTW-20-200	4901600	14x18	20 - 200 Nm	DRO40•DRO42•DRO50•DRO63
DRTW-60-340	4901800	14x18	60 - 340 Nm	DRO63 (for CP432DG)

Accessories Mounting Devices TBRS



Mounting Devices TBRS with Roller Bearing

Description	Order-No.	D	for holder shanks
TBR525	4980200	25	HSK25
TBR532	4980400	32	HSK32•C3
TBR540	4980600	40	HSK40•C4
TBR546	4980800	46	MAS/BT30
TBR550	4981000	50	SK30•HSK50•C5
TBR563	4981200	63	SK40•HSK63•C6•MAS/BT40•CAT40
TBR580	4981600	80	HSK80•C8
TBR597	4981800	97,5	SK50
TBR5100	4982000	100	HSK100•MAS/BT50•CAT50

= for easy and safe clamping of holder shanks at the flange using rollers for mounting and removing cutting tools, therefore self clamping and ideal for all common holder shanks.



Accessories Precision Collets GERC-HP DIN ISO15488-B (ER/ESX)

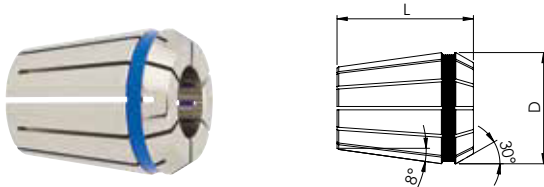

Precision Collets GERC-HP – 2 µm for GERC11-HP for GERC40-HP

Description	Order-No.	□	D	L	Pro- file	from-to	steps
4004E GERC8-HP	1361001	5 µm	8,5	13,6	●	1,0 – 5,0	0,5
	1361004					1/16"•1/8"•3/16"	
4008E GERC11-HP	1361101	2 µm	11,3	18	●	1,0 – 7,0	0,5
	1361104					1/16"•3/32"•1/8"•5/32"•3/16"•7/32"•1/4"	
426E GERC16-HP	1361301	2 µm	17	27,5	●	1,0 – 10,0	0,5
						1,1 – 1,4 + 1,6 – 1,9 + 2,1 – 2,4	0,1
						2,6 – 2,9 + 3,1 – 3,4 + 3,6 – 3,8	0,1
						5,6•6,3•7,1	
428E GERC20-HP	1361401	2 µm	21	31,5	●	1,0 – 13,0	0,5
	1361404					1/8"•3/16"•1/4"•5/16"•3/8"•7/16"•1/2"	
430E GERC25-HP	1361501	2 µm	26	34	●	1,0 – 16,0	0,5
	1361504					1/8"•3/16"•1/4"•5/16"•3/8"•7/16"•1/2"•9/16"•5/8"	
470E GERC32-HP	1361601	2 µm	33	40	●	2,0 – 20,0	0,5
	1361604					1/8"•3/16"•1/4"•5/16"•3/8"•7/16"•1/2"•9/16"•5/8"•11/16"•3/4"	
472E GERC40-HP	1361701	2 µm	41	46	●	3,0 – 26,0	0,5
	1361704					1/8"•3/16"•1/4"•5/16"•3/8"•7/16"•1/2"•9/16"•5/8"•11/16"•3/4"•13/16"•7/8"•1"	

Ordering Example

Complete Order-No. with the diameter,
 e.g. GERC32-HP Ø 6 mm = Order-No. 13616010600 und Ø 1/8"
 = Order-No. 13616040318
 Inch conversion table please see page 82!

Accessories Precision Collets GERC-HPD

Similar DIN ISO 15488-A

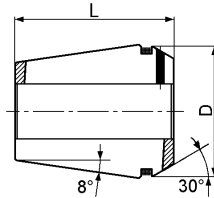

GER

Precision Collets GERC-HPD with Seals for IC (Inner Coolant Supply) – 2 µm

Description	Order-No.	□	D	L	Pro- file	from-to	steps
4012E GERC11-HPD	1362101	2 µm	11,2	18	●	3,0-6,0	1,0
	1362104					1/8"•3/16"•1/4"	
425E GERC16-HPD	1362301	2 µm	16,7	27,5	●	3,0-10,0	1,0
	1362304					1/8"•3/16"•1/4"•5/16"•3/8"	
427E GERC20-HPD	1362401	2 µm	20,7	31,5	●	3,0-12,0	1,0
	1362404					1/8"•3/16"•1/4"•5/16"•3/8"•7/16"•1/2"	
429E GERC25-HPD	1362501	2 µm	25,7	34	●	3,0-16,0	1,0
	1362504					1/8"•3/16"•1/4"•5/16"•3/8"•7/16"•1/2"•9/16"•5/8"	
469E GERC32-HPD	1362601	2 µm	32,7	40	●	3,0-20,0	1,0
	1362604					1/8"•3/16"•1/4"•5/16"•3/8"•7/16"•1/2"•9/16"•5/8"•11/16"•3/4"	
471E GERC40-HPD	1362701	2 µm	40,7	46	●	6,0•8,0•10,0•12,0•14,0•16,0•18,0•20,0•22,0•25,0	

Ordering Example

Complete Order-No. with the diameter,
 e.g. GERC20-HPD Ø 8 mm = Order-No. 13624010800
 or Ø 3/16" = Order-No. 13624040476
 Inch conversion table please see page 82!



Accessories Precision Collets GERC-HPDD Similar DIN ISO 15488-A

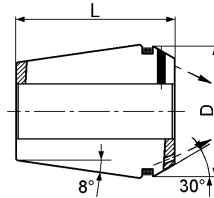

Precision Collets GERC-HPDD with Seals for IC (Inner Coolant Supply) and Jet Holes – 2 µm

Description	Order-No.	□	D	L	Pro- file	Standard bore
425E GERC16-HPDD	1363301	2 µm	16,7	27,5	●	4,0•6,0•8,0
427E GERC20-HPDD	1363401	2 µm	20,7	31,5	●	4,0•6,0•8,0•10,0
429E GERC25-HPDD	1363501	2 µm	25,7	34	●	4,0•6,0•8,0•10,0•12,0•14,0
469E GERC32-HPDD	1363601	2 µm	32,7	40	●	4,0•6,0•8,0•10,0•12,0•14,0•16,0•18,0•20,0
471E GERC40-HPDD	1363701	2 µm	40,7	46	●	10,0•12,0•14,0•16,0•18,0•20,0•25,0

Ordering Example

Complete Order-No. with the diameter,
 e.g. GERC25-HPDD Ø 8 mm = Order-No. 13635010800

Use of shanks with lateral flat with GERC-HPD and GERC-HPDD

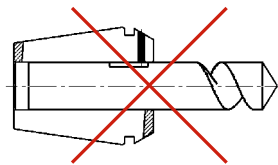

Incorrect Position!

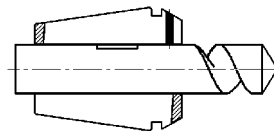

Correct Position!

Accessories Tap Collets GERC-GBD

Similar DIN ISO15488-A

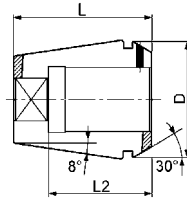

Tap Collets GERC-GBD with Internal Square Drive and Seals for IC (Inner Coolant Supply) – 10µm

Description	Order-No.	□	D	L	L2	Profile	Standard bore (Shank-Ø/Square)
4031E GERC16-GBD	1382301	10µm	16,7	27,5	18	●/■	2,8/2,1•3,5/2,7•4,0/3,2•4,5/3,55•5,0/4,0•5,5/4,5•6,0/5,0•6,3/5,0•7,0/5,6•7,1/5,6
					22	●/■	8,0/6,3•9,0/7,1
4276E GERC20-GBD	1382401	10µm	20,7	31,5	18	●/■	3,5/2,7•4,0/3,2•4,5/3,55•5,0/4,0•5,5/4,5•6,0/5,0•6,3/5,0•7,0/5,6•7,1/5,6
					22	●/■	8,0/6,3•9,0/7,1
					25	●/■	10,0/8,0•11,0/9,0•11,2/9,0•12,0/9,0
4282E GERC25-GBD	1382501	10µm	25,7	34	18	●/■	3,5/2,7•4,0/3,2•4,5/3,55•5,0/4,0•5,5/4,5•6,0/5,0•6,3/5,0•7,0/5,6•7,1/5,6
					22	●/■	8,0/6,3•9,0/7,1
					25	●/■	10,0/8,0•11,0/9,0•11,2/9,0•12,0/9,0•12,5/10,0•14,0/11,2•16,0/12,5
4537E GERC32-GBD	1382601	10µm	32,7	40	18	●/■	4,0/3,2•4,5/3,55•5,0/4,0•5,5/4,5•6,0/5,0•6,3/5,0•7,0/5,6•7,1/5,6
					22	●/■	8,0/6,3•9,0/7,1
					25	●/■	10,0/8,0•11,0/9,0•11,2/9,0•12,0/9,0•12,5/10,0•14,0/11,2•16,0/12,5•18,0/14,5
					28	●/■	20,0/16,0
4716E GERC40-GBD	1382701	10µm	40,7	46	18	●/■	6,0/5,0•6,3/5,0•7,0/5,6•7,1/5,6
					22	●/■	8,0/6,3•9,0/7,1
					25	●/■	10,0/8,0•11,0/9,0•11,2/9,0•12,0/9,0•12,5/10,0•14,0/11,2•16,0/12,5
					33	●/■	18,0/14,5•20,0/16,0•22,0/18,0•25,0/20,0

Ordering Example

Complete Order-No. with the diameter,

e.g. GERC40-GBD Ø 8,0/6,3 mm = Order-No. 13827010800



Accessories Tap Collets GERC-GBDD

Similar DIN ISO15488-A

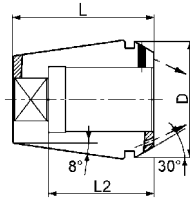

Tap Collets GERC-GBDD with Internal Square Drive, Seals for IC (Inner Coolant Supply) and Jet Holes – 10µm

Description	Order-No.	∅	D	L	L2	Profile	Standard bore (Shank-∅/Square)
4031E GERC16-GBDD	1383301	10µm	16,7	27,5	18	●/■	3,5/2,7•4,5/3,55•6,0/5,0•7,0/5,6
					22		8,0/6,3
4276E GERC20-GBDD	1383401	10µm	20,7	31,5	18	●/■	4,5/3,55•6,0/5,0•7,0/5,6
					22		8,0/6,3•9,0/7,1
					25		10,0/8,0
4282E GERC25-GBDD	1383501	10µm	25,7	34	18	●/■	4,5/3,55•6,0/5,0•7,0/5,6
					22		8,0/6,3•9,0/7,1
					25		10,0/8,0•11,0/9,0•12,0/9,0•14,0/11,2
4537E GERC32-GBDD	1383601	10µm	32,7	40	18	●/■	4,5/3,55•6,0/5,0•7,0/5,6
					22		8,0/6,3•9,0/7,1
					25		10,0/8,0•11,0/9,0•12,0/9,0•14,0/11,2
					30		18,0/14,5•20,0/16,0

Ordering Example

Complete Order-No. with the diameter,

e.g. GERC25-GBDD ∅ 10,0/8,0 mm = Order-No. 13835011000

Accessories Precision Collets GOZ-DG-HP DIN ISO10897-B

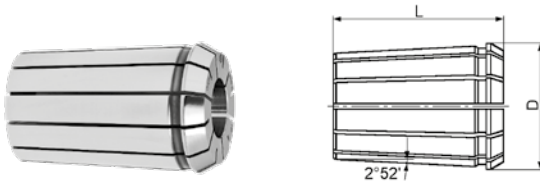

GOZ

Precision Collets GOZ-DG-HP (double slotted) – 3 µm

Description	Order-No.	□	D	L	Pro- file	Standard bore
462E FM25DG-HP	1224201	3µm	35,05	52	●	3,0•4,0•6,0•8,0•10,0•12,0•14,0•16,0•18,0•20,0•25,0

Ordering Example

Complete Order-No. with the diameter,

e.g. FM25DG-HP Ø 20mm = Order-No. 12242012000

Accessories Precision Collets GOZ-DG DIN ISO10897-B

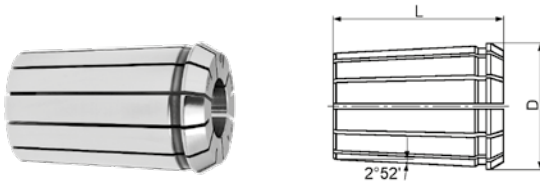

GOZ

Precision Collets GOZ-DG (double slotted) – 6 µm or 10 µm

Description	Order-No.	□	D	L	Pro- file	from-to	steps
462E FM25DG	1220201	6µm	35,05	52	●	2,0 – 25,0	0,5
	1220204					1/8"•1/4"•3/8"•1/2"•5/8"•3/4"•1"	
467E FM32DG	1220301	10µm	43,7	60	●	4,0 – 32,0	0,5

Ordering Example

Complete Order-No. with the diameter,

e.g. FM25DG Ø 16 mm = Order-No. 12202011600

or Ø 1/4" = Order-No. 12202040635

Inch conversion table please see page 83!

Accessories Sealing Discs DI|DIG

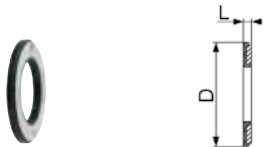

GER

Sealing Discs DI

Description	Order-No.	D	L	Pro- file	from-to	steps	range	for Clamping Nut	for Collets
DI16	2430301	12,6	2	●	1,0-10,0	0,5	+0,4/-0,1	HPC16MS-DI• HPC16M-DI• HPC16C-DI• HPC16-DI	GERC16-HP
	2430304			●	1/8"•3/16"•1/4"•5/16"•3/8"				
DI20	2440301	15,8		●	2,0-13,0	0,5		HPC20-DI	GERC20-HP
DI25	2450301	20,2		●	2,0-16,0			HPC25-DI	GERC25-HP
DI32	2460301	26,2		●	2,0-20,0	0,5		HPC32-DI	GERC32-HP
	2460304			●	1/8"•3/16"•1/4"•5/16"•3/8"• 1/2"•5/8"•3/4"				
DI40	2470301	34,2		●	3,0-26,0	0,5		HPC40-DI	GERC40-HP
	2470304			●	1/8"•3/16"•1/4"•5/16"•3/8"• 1/2"•5/8"•3/4"•7/8"•1"				

Ordering Example

Complete Order-No. with the diameter,
 e.g. DI32 Ø 16 mm = Order-No. 24603011600 or Ø 1/2"
 = Order-No. 24603041270

Inch conversion table please see page 82!

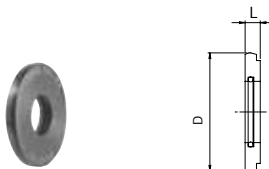

GOZ

Sealing Discs DIG

Description	Order-No.	D	L	Pro- file	from-to	steps	range	for Clamping Nut	for Collets
DIG225 (DS50)	2159201	31	4	●	4,0-25,0	1,0	-0,5	HPC225-DIG	FM25DG•HP
DIG432 (DS60)	2159301	40		●	5,0-32,0			HPC432-DIG	FM32DG

Accessories Data Carrier BIS



GER

GOZ

GB

Data Carrier BIS (BALLUFF)

Description	Order-No.	for Collet Chucks
BIS C-122-04/L	4499900	all HSK-A

Accessories Adjustable Stop Screws AS-U|AS-W

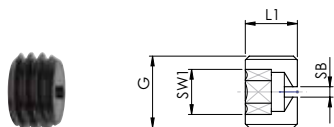

Adjustable Stop Screws AS-U

Description	Order-No.	G	SW1	SB	L1	for Collet Chucks
AS-CP11-U	44981000100	M8x1	4	1,6	8	CP11M•CPC11M
AS-CP16-U	44982000100	M11x1	6			CP16M•CPC16M•CP16•CPC16
AS-CP20-U	44983000100	M14x1	5	1,5		CP20
AS-CP25/32/225-U	44984000101	M18x2,5			10	CP25•CP32•CP225DG
AS-CP25-U	44984000102	M18x1,5	6	1,6		CP25
AS-CP32/225-U	44984000103	M22x1,5				CP32•CP225DG
AS-CP40-U	44985000100	M28x1,5			25	CP40

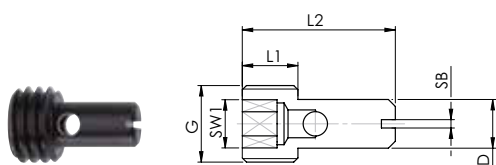

Adjustable Stop Screws AS-W

Description	Order-No.	G	SW1	SB	L1	L2	D	for Collet Chucks
AS-CP11-W	44981000200	M8x1	4			18	4,5	CP11M•CPC11M
AS-CP16-W	44982000200	M11x1		1,2	8	22	7	CP16M•CPC16M•CP16•CPC16
AS-CP25/32/225-W	44984000201	M18x2,5	6					CP25•CP32•CP225DG
AS-CP25-W	44984000202	M18x1,5		1,6	10	28	10,5	CP25
AS-CP32/225-W	44984000203	M22x1,5						CP32•CP225DG

Accessories Taper Wipers KWK



Taper Wipers KWK-ER

Description	Order-No.	for Chucks and Holders Type
KWK-ER11	2220100	CP11M•CPC11M
KWK-ER16	2220200	CP16•CPC16•CP16M•ST16-GB
KWK-ER20	2220300	CP20•ST20-GB
KWK-ER25	2220400	CP25•ST25-GB
KWK-ER32	2220500	CP32•ST32-GB

Accessories Coolant Supply Tubes and Wrenches IKR|SCHL-IKR



Coolant Supply Tubes IKR

Description	Order-No.	for HSK	Form	G
IKR-HSK25	2490200	25	A and E	M8x1
IKR-HSK32	2490300	32		M10x1
IKR-HSK40	2490400	40		M12x1
IKR-HSK50	2490500	50		M16x1
IKR-HSK63	2490600	63		M18x1
IKR-HSK80	2490700	80		M20x1,5
IKR-HSK100	2490800	100		M24x1,5



Wrenches SCHL-IKR for Coolant Supply Tubes

Description	Order-No.	for HSK
SCHL-IKR-HSK25	2492200	25
SCHL-IKR-HSK32	2492300	32
SCHL-IKR-HSK40	2492400	40
SCHL-IKR-HSK50	2492500	50
SCHL-IKR-HSK63	2492600	63
SCHL-IKR-HSK80	2492700	80
SCHL-IKR-HSK100	2492800	100

Accessories Pull Studs AZB

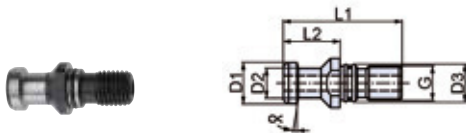

Pull Studs AZB DIN69872-A with bore

Description	Order-No.	L1	L2	D1	D2	D3	α	G	max. Nm	for Taper Shanks
AZB30-DIN-A	2910300	44	24	13	9	13	15°	M12	20	30
AZB40-DIN-A	2910500	54	26	19	14	17	15°	M16	50	40
AZB50-DIN-A	2910700	74	34	28	21	25	15°	M24	150	50

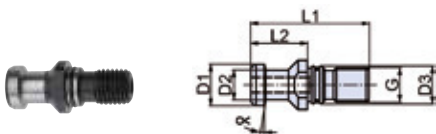

Pull Studs AZB DIN69872-B without bore

Description	Order-No.	L1	L2	D1	D2	D3	α	G	max. Nm	for Taper Shanks
AZB30-DIN-B	2911300	44	24	13	9	13	15°	M12	20	30
AZB40-DIN-B	2911500	54	26	19	14	17	15°	M16	50	40
AZB50-DIN-B	2911700	74	34	28	21	25	15°	M24	150	50

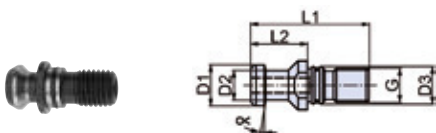

Pull Studs AZB ISO 7388/II-B with bore

Description	Order-No.	L1	L2	D1	D2	D3	α	G	max. Nm	for Taper Shanks
AZB40-ISO-A	2920500	44,5	16,4	18,95	12,95	17	45°	M16	50	40
AZB50-ISO-A	2920700	65	25,5	29	19,6	25	45°	M24	150	50

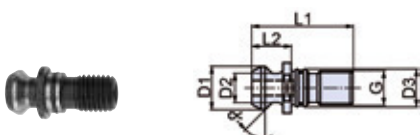

Pull Studs AZB ISO 7388-B without bore

Description	Order-No.	L1	L2	D1	D2	D3	α	G	max. Nm	for Taper Shanks
AZB40-ISO-B	2921500	44,5	16,4	18,95	12,95	17	45°	M16	50	40
AZB50-ISO-B	2921700	65	25,5	29	19,6	25	45°	M24	150	50

Accessories Pull Studs AZB

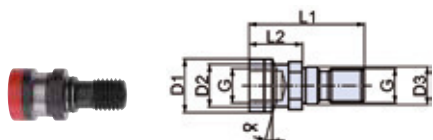

Pull Studs AZB DIN2080 with inner thread

Description	Order-No.	L1	L2	D1	D2	D3	α	G	max. Nm	for Taper Shanks
AZB40-DIN2080-G	2943500	53	25	25	21,6	17	15°	M16	50	40
AZB50-DIN2080-G	2943700	65	25,1	39,3	32	25	15°	M24	150	50

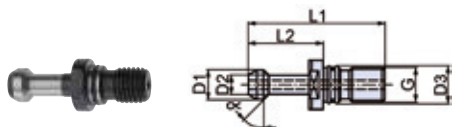

Pull Studs AZB MAS/BT 45° (JIS B 6339) with bore

Description	Order-No.	L1	L2	D1	D2	D3	α	G	max. Nm	for Taper Shanks
AZB30-BT-45°-A	2930300	43	23	11	7	12,5	45°	M12	20	30
AZB40-BT-45°-A	2930500	60	35	15	10	17	45°	M16	50	40
AZB50-BT-45°-A	2930700	85	45	23	17	25	45°	M24	150	50

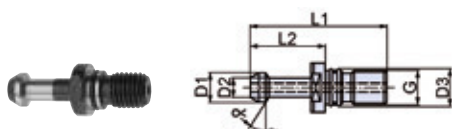

Pull Studs AZB MAS/BT 30° (JIS B 6339) with bore

Description	Order-No.	L1	L2	D1	D2	D3	α	G	max. Nm	for Taper Shanks
AZB30-BT-30°-A	2931300	43	23	11	7	12,5	30°	M12	20	30
AZB40-BT-30°-A	2931500	60	35	15	10	17	30°	M16	50	40
AZB50-BT-30°-A	2931700	85	45	23	17	25	30°	M24	150	50

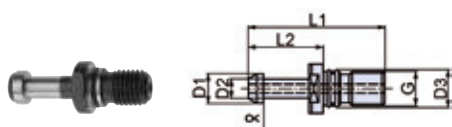

Pull Studs AZB MAS/BT 90° (JIS B 6339) with bore

Description	Order-No.	L1	L2	D1	D2	D3	α	G	max. Nm	for Taper Shanks
AZB40-BT-90°-A	2932500	60	35	15	10	17	90°	M16	50	40
AZB50-BT-90°-A	2932700	85	45	23	17	25	90°	M24	150	50

Accessories Pull Studs AZB

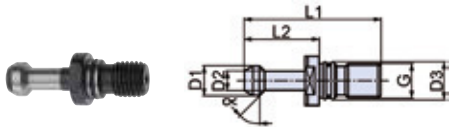

GER

GOZ

GB

Pull Studs AZB MAS/BT 45° (JIS B 6339) without bore

Description	Order-No.	L1	L2	D1	D2	D3	α	G	max. Nm	for Taper Shanks
AZB30-BT-45°-B	2933300	43	23	11	7	12,5	45°	M12	20	30
AZB40-BT-45°-B	2933500	60	35	15	10	17	45°	M16	50	40
AZB50-BT-45°-B	2933700	85	45	23	17	25	45°	M24	150	50

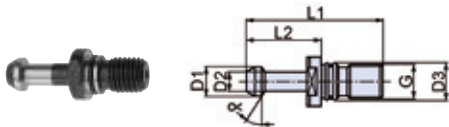

GER

GOZ

GB

Pull Studs AZB MAS/BT 30° (JIS B 6339) without bore

Description	Order-No.	L1	L2	D1	D2	D3	α	G	max. Nm	for Taper Shanks
AZB30-BT-30°-B	2934300	43	23	11	7	12,5	30°	M12	20	30
AZB40-BT-30°-B	2934500	60	35	15	10	17	30°	M16	50	40
AZB50-BT-30°-B	2934700	85	45	23	17	25	30°	M24	150	50

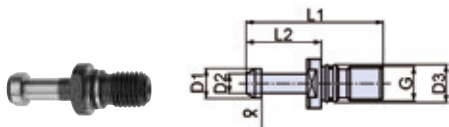

GER

GOZ

GB

Pull Studs AZB MAS/BT 90° (JIS B 6339) without bore

Description	Order-No.	L1	L2	D1	D2	D3	α	G	max. Nm	for Taper Shanks
AZB40-BT-90°-B	2935500	60	35	15	10	17	90°	M16	50	40
AZB50-BT-90°-B	2935700	85	45	23	17	25	90°	M24	150	50

Information

Conversion Table

Conversion of inch to metric, which is in accordance with the last 4 digits of the order number:

1/16" = 0159	3/32" = 0238	1/8" = 0318	5/32" = 0397	3/16" = 0476	7/32" = 0556	1/4" = 0635	9/32" = 0714
5/16" = 0794	11/32" = 0873	3/8" = 0953	13/32" = 1032	7/16" = 1111	1/2" = 1270	9/16" = 1429	5/8" = 1588
11/16" = 1746	3/4" = 1905	13/16" = 2064	7/8" = 2223	1" = 2540			

Ordering Example

Collet Chuck	e.g. CP32-AD40-A=100	e.g. CP32-B40-A=100
+ Clamping Nut	e.g. HPC32	e.g. HPC32-DI
+ Sealing Disc	none	e.g. DI32
+ Collet	e.g. GERC32-HP e.g. GERC32-HPD e.g. GERC32-HPDD e.g. GERC32-GBD e.g. GERC32-GBDD	e.g. GERC32-HP
+ Accessories	Wrenches, Adjustable Stop Screws, Taper Wipers, Coolant Supply Tubes, Pull Studs, Mounting Devices	

In order to guarantee the highest possible flexibility of the Precision Collet Chuck CENTROJP, the Collet Chucks, Clamping Nuts, Collets and the accessories **MUST** be ordered separately.

Please do not hesitate to contact us if you require a version that is not included in this catalogue.

Technical Information | Balancing

Imbalance

- = Rotor centre of gravity **2** is outside its rotational axis **1** (=offset e **3**)

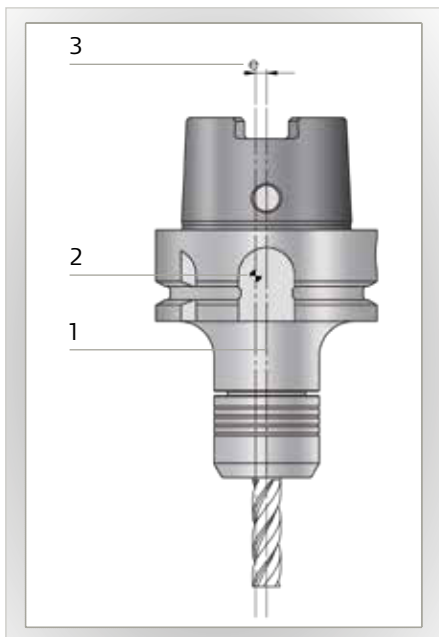

Causes

- = Unsymmetrical bores and milling at the tool holder (e.g. taper shanks DIN 69871 and DIN 69893 HSK form A and B)
- = Unsymmetrical shape of the tool (e.g. clamping surface at the milling cutter)
- = Production tolerances (runout)
- = Spindle runout

Consequences

Centrifugal forces cause vibrations.

These cause:

- = Damage to the spindle bearings
- = Mediocre surface quality
- = Insufficient repeatability of accuracy
- = Reduction in tool life
- = Noise

Requirements

Balancing is necessary whenever optimum working conditions have to be achieved e.g.

- = Surface quality
- = Production accuracies

- = Tool operational life
- = or if prescribed by the machine tool manufacturer (warranty claims!)

However, it is only economically sensible to balance at speeds of 8,000 r.p.m. or higher. At speeds lower than this the cutting forces are as a rule greater than the imbalance forces.

Balancing means – determining the centre of gravity axis and moving it back to the axis of rotation.

What Balance Grade

Our CENTRO|P precision collet chucks are fine balanced as standard. Information regarding the balance quality (in relation to the rpm or the minimum residual imbalance) you can find on the respective product page.

r.p.m. limits – Fine balancing in special execution is possible

Adaptation	Speed (up to / r.p.m.)	U	Information
HSK-25*	to 80.000 r.p.m.	≤ 1gmm	The max. speeds (additional fine balancing necessary) were recommended as guideline values as limit speeds for the HSK interfaces within the framework of HSK standardisation, as the speed has the greatest influence and is also the limit for spindle and spindle bearings. The max. rpm, however, should be adapted to the specific cutting process.
HSK-32*	to 50.000 r.p.m.	≤ 1gmm	
HSK-40*	to 42.000 r.p.m.	≤ 1gmm	
HSK-50*	to 30.000 r.p.m.	≤ 1gmm	
HSK-63	to 25.000 r.p.m.		
HSK-80	to 20.000 r.p.m.		
HSK-100	to 16.000 r.p.m.		The values for chucks with taper shanks are empirical values which should not be exceeded (the values depend to a very great extent on the respective machine spindle)
SK30*	to 20.000 r.p.m.		
SK40	to 20.000 r.p.m.		
SK50	to 16.000 r.p.m.		

No liability can be accepted for these specifications.

* All collet chucks with a total weight below 1kg → minimum residual imbalance

Please mind:

CENTRO|P types with long gauge length and a high length/diameter ratio (L/D) should not be run at maximum rpm. Please refer to our specific recommendations.

Limits to Balancing Grade

According to ISO standard 1940, the balancing standard is described using G. The balancing standard G corresponds to g/mmkg or µm and is in relation to the speed.

As an explanation: At a speed of 9,500 r.p.m and a weight of 1 kg G2.5 means a permissible offset between the rotational axis and the centre of gravity axis of the spindle of 2.5 µm. At a speed of 19,000 r.p.m. it would be 1.25 µm and at 38,000 r.p.m. 0.625 µm. If the tool holder together with the tool weighs half the amount, i.e. 0.5 kg, the balance will also be halved.

Until now, so as to minimise guarantee claims the machine or spindle manufacturers demanded such excessively fine balancing that their demands could only be met by balancing the chuck and the cutter on the machine spindle.

In order to avoid the high economic costs this caused, draft standard DIN 69888 covering balancing requirements on rotating tool systems was agreed jointly by the machine, spindle, balancing machine and tool manufacturers. The standard is expected to be adopted officially in 2007, and it is a sensible solution in both technical and economic terms, since in that norm all residual imbalances are indicated in „gmm“ and not assigned to a balance grade. Moreover, possible tool change faults are considered.

Grade steps to DIN ISO 1940-1

Permissible residual imbalances in relation to the balancing body weight for different grade steps G depending on the highest operating speed

General Formula

$$G = e \times \omega = \frac{U}{m_r} \times \frac{2 \times \pi \times n}{60} = \frac{U \times \pi \times n}{m_r \times 30}$$

then
$$U = \frac{G \times m_r \times 30}{\pi \times n}$$

- G = Balancing grade step [mm/s]
- e = Centre of gravity concentricity, related imbalance [gmm/kg or µm]
- n = Speed [r.p.m.]
- U = Imbalance [gmm]
- ω = Angular velocity [1/sec]
- m_r = Weight of the tool or the rotor [g]

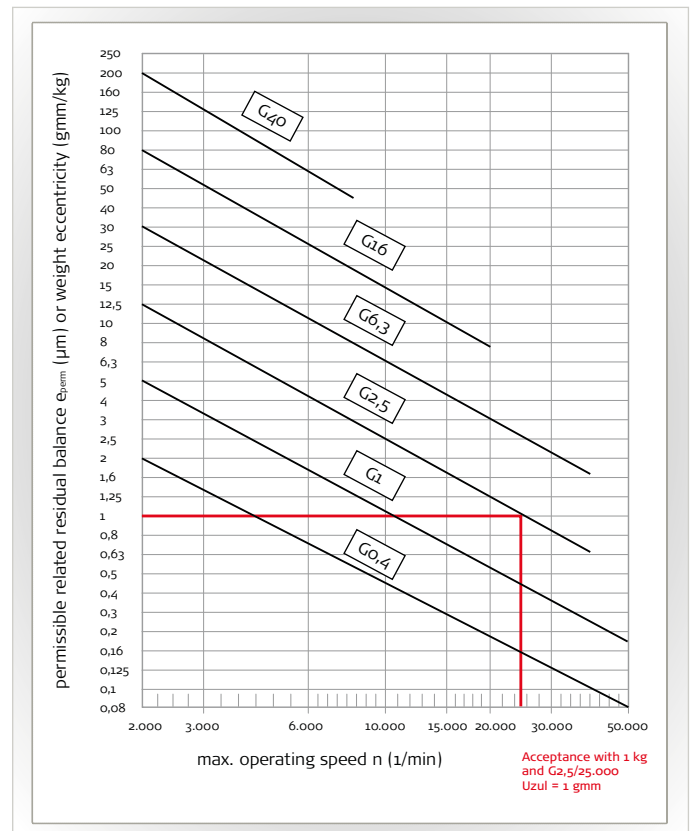

Technical Information | Balancing

Calculation of the total balancing grade of the assembled system (spindle • tool holder • tool)

Illustration of balancing grade total

$$U_{total} = U_{Spindle} + U_{Tool\ holder} + U_{Tool}$$

Example

$$U_{total} = U_{Spindle\ (G\ 0,4)} + U_{Tool\ holder\ (G\ 2,5)} + U_{Tool\ (G\ 6,3)}$$

Calculation of eccentricity

$$U = \frac{G \times 60}{2 \times \pi \times n} \times m$$

$$U_{Spindle} = \frac{0,4 \times 60}{2 \times \pi \times 30.000} \times 15.000 = 1,910$$

$$U_{Tool\ holder} = \frac{2,5 \times 60}{2 \times \pi \times 30.000} \times 1.487 = 1,176$$

$$U_{Tool} = \frac{6,3 \times 60}{2 \times \pi \times 30.000} \times 230 = 0,461$$

$$M_{total\ in\ g} = 16.708 \quad U_{total\ in\ gmm} = 3,547$$

Balancing grade conversion of the total system

$$G = U_{total} \times 2 \times \pi \times \frac{n}{60 \times m_{total}}$$

Example

$$G = 3,547_{gmm} \times 2 \times \pi \times \frac{3.000 \times 1/min}{60 \times 16.708g} = 0,67$$

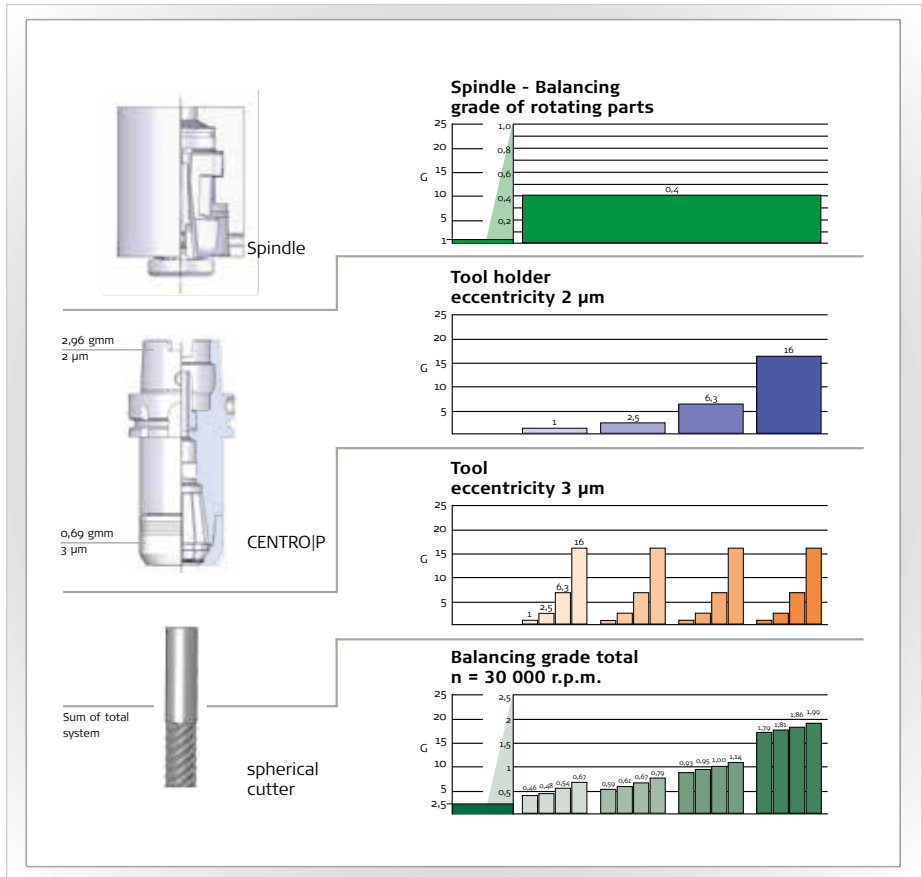

Calculation scheme with kind permission of Gühring oHG, Albstadt

Static or Dynamic Balancing

In practice balancing is very often carried out in one plane (Fig. 1). But the tool demonstrates only one centre of gravity error. The main axis of inertia and the rotational axis run in parallel to each other. This is known as "static" imbalance when the tool holder is relatively short in comparison with the diameter of the spindle holder.

In the case of long and thin tool holders balancing in two planes (Fig. 2) is sensible. In such cases, in addition to the existing centre of gravity error the main axis of inertia and the rotational axis no longer run in parallel to each other. This is known as a "dynamic" imbalance. The resulting imbalance moment generates a wobbling movement of the tool seat.

The following rule of thumb may act as a guide to whether the tool holder should be balanced as "static" or "dynamic":

Static balancing applies to tool holders
 = which have an operating speed of less than 20,000 r.p.m.
 = whose length (A) is less than double the diameter (D₂)

Dynamic balancing applies to tool holders
 = which have an operating speed over 20,000 r.p.m.
 = whose length (A) is more than double the diameter (D₂)

All single-cutter drilling and boring tools should be balanced in two planes.

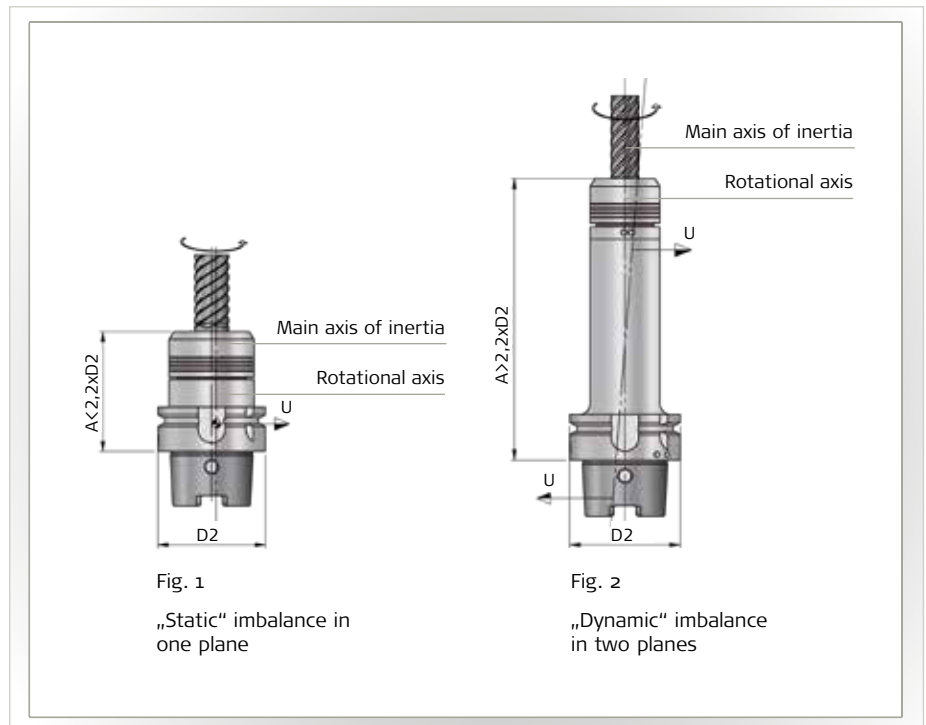

FAHRION [®]
PRÄZISION

And all runs smoothly.

FAHRION offers a wide selection of precision collets, precision collet chucks as well as precision products for workpiece clamping which fulfil maximum requirements in terms of concentricity, service life and manufacturing quality. In doing so, FAHRION pays particular attention to user-friendly technology oriented towards the practical requirements of the users, which is constantly advanced.

The latest catalogue information is available
at any times at www.fahrion.de

Eugen Fahrion GmbH & Co. KG
Forststraße 54
73667 Kaisersbach
Germany
Phone +49 7184 9282-0
Fax +49 7184 9282-92
info@fahrion.de
www.fahrion.de
www.shop.fahrion.de