

www.ferraljl.com



Ferral – José Luís & Ca. Lda.
Rua dos Sobrais, n.º 655 - Zona Industrial Sul
Apartado 70, 3885-307 Cortegaça OVR - Portugal
tel. (+351) 256 790 800 | fax. (+351) 256 790 801
email: ferraljl@ferraljl.com

Cofinanciado por:



UNIÃO EUROPEIA
Fundo Europeu
de Desenvolvimento Regional

2018

FERRAL

 FERRAL®

2018



COMPROMISSO DE SEGURANÇA



FERRAL
INDUSTRIAL

FERRAL



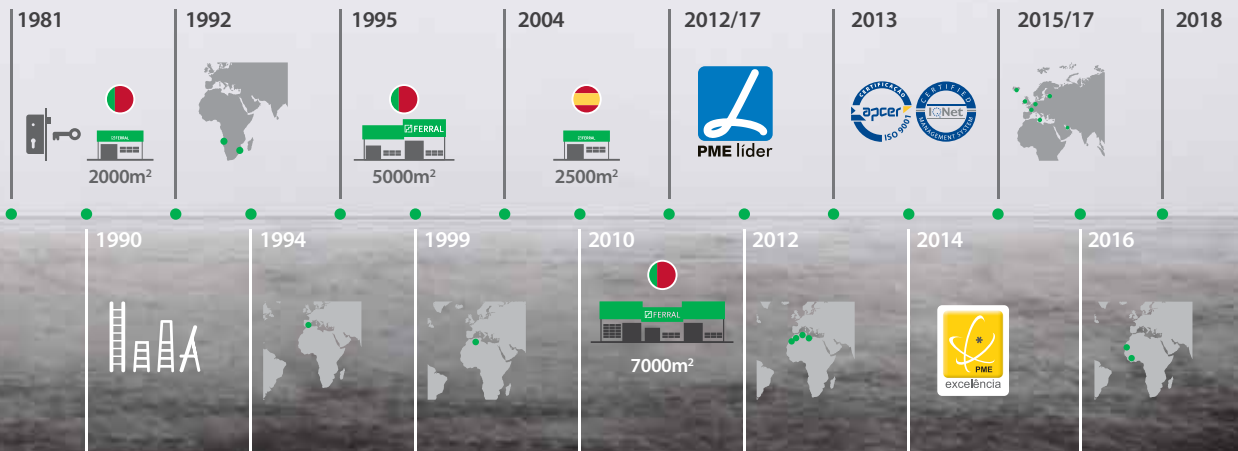
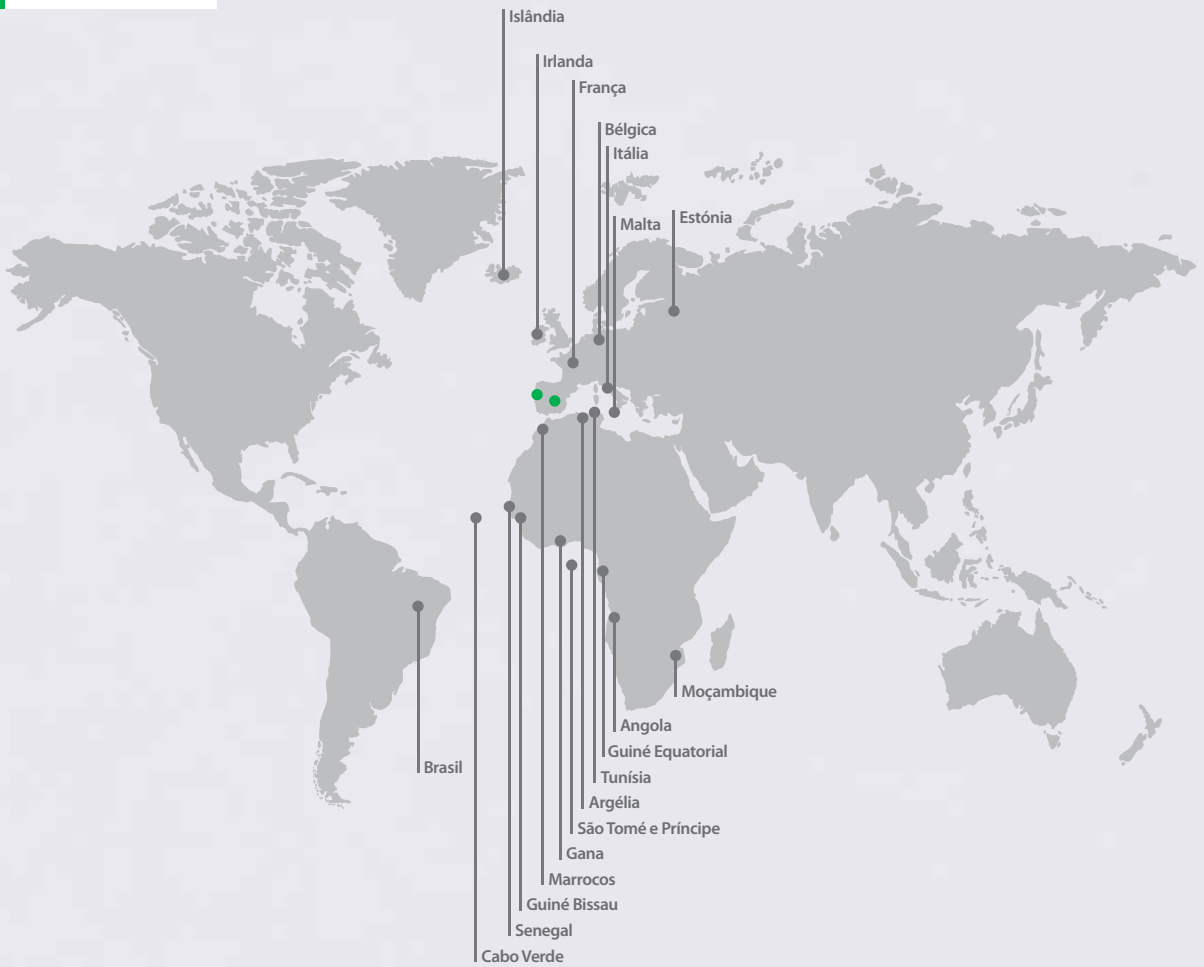

- 06 **Escadotes**
Stepladders
Escabeaux
Escaleras Dométicas

- 22 **Escadas Multifunções**
Multi-purpose Ladders
Échelles Multifonctions
Escaleras Multifunción

- 31 **Escadas**
Ladders
Échelles
Escaleras Industriales

- 53 **Andaimes**
Scaffolding
Échafaudage
Andamios

- 57 **Acessórios**
Accessories
Accessoires
Accesorios

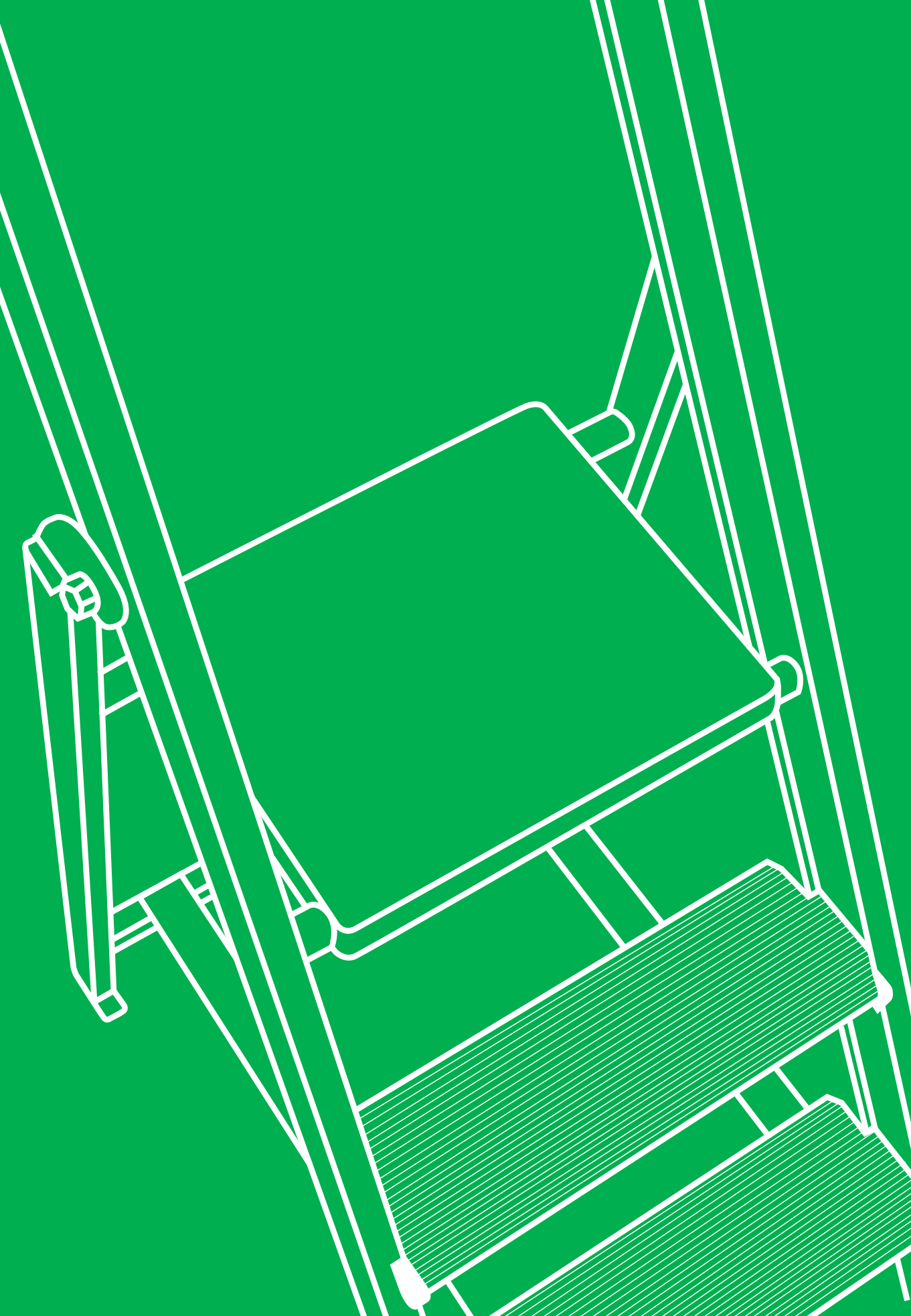



FERRAL

EXTRA

ESCADOTES
STEPLADDERS
ESCABEAUX
ESCALERAS DOMÉSTICAS

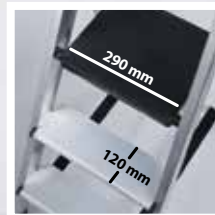

560 4620 023132	3	0,68 m	2,68 m	1,28 m	0,44 m	1,41 m	0,12 m	5,95 kg
560 4620 023149	4	0,91 m	2,91 m	1,51 m	0,47 m	1,66 m	0,12 m	7,17 kg
560 4620 023156	5	1,14 m	3,14 m	1,74 m	0,49 m	1,91 m	0,12 m	8,43 kg
560 4620 023163	6	1,37 m	3,37 m	1,97 m	0,52 m	2,16 m	0,12 m	9,99 kg
560 4620 023170	7	1,60 m	3,60 m	2,20 m	0,54 m	2,41 m	0,12 m	11,32 kg
560 4620 023187	8	1,83 m	3,83 m	2,43 m	0,57 m	2,66 m	0,12 m	12,68 kg
560 4620 023194	9	2,06 m	4,06 m	2,66 m	0,59 m	2,91 m	0,12 m	14,07 kg

Escadote profissional em alumínio - Soldadura Robotizada. Degraus com largura Extra (120 mm), articulações de alta qualidade e porta ferramentas. Cintas de segurança e pés antiderrapantes Extra.

Professional aluminium stepladder - Robotic Welding. Extra deep tread aluminum steps (120 mm), high quality hinges and tool holder. Safety belts and Extra slip-resistant feet.

Escabeau professionnel en aluminium - Soudage Robotique. Marches Extra-larges (120 mm), charnières de haute qualité et porte-outils. Sangles de sécurité et sabot emboîtable antidérapant Extra.

Escalera profesional de aluminio - Soldadura Robótica. Peldaños Extra-anchos (120 mm), bisagras de alta calidad y bandeja porta-herramientas. Cintas de seguridad y tacos antideslizantes Extra.



Opção
option | option | opción



DUO

ESCADOTES
STEPLADDERS
ESCABEAUX
ESCALERAS DOMÉSTICAS

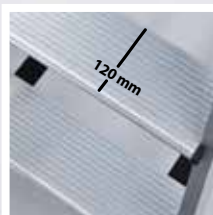

Barcode	Steps	Height	Width	Depth	Step Depth	Step Width	Step Height	Weight
560 4620 023323	2	0,26 m	2,26 m	0,50 m	0,45 m	0,61 m	0,23 m	4,93 kg
560 4620 023330	3	0,26 m	2,26 m	0,74 m	0,47 m	0,86 m	0,23 m	6,77 kg
560 4620 023347	4	0,50 m	2,50 m	0,98 m	0,50 m	1,11 m	0,23 m	8,67 kg
560 4620 023354	5	0,74 m	2,74 m	1,22 m	0,52 m	1,36 m	0,23 m	10,65 kg
560 4620 023361	6	0,98 m	2,98 m	1,46 m	0,55 m	1,61 m	0,23 m	12,70 kg
560 4620 023378	7	1,22 m	3,22 m	1,70 m	0,57 m	1,86 m	0,23 m	14,81 kg
560 4620 023385	8	1,46 m	3,46 m	1,94 m	0,60 m	2,11 m	0,23 m	16,99 kg



Opção
option | option | opción

Escadote profissional de duplo acesso em alumínio - Soldadura Robotizada. Degraus Extra com 120 mm de largura e articulações de segurança. Cintas de segurança e pés antiderrapantes Extra.

Professional aluminium double-sided stepladder - Robotic Welding. Extra deep tread aluminum steps (120 mm) and safety hinges. Safety belts and Extra slip-resistant feet.

Escabeau professionnel double accès en aluminium - Soudage Robotique. Marches Extra-larges (120 mm) et charnières de sécurité. Sangles de sécurité et sabot emboitable antidérapant Extra.

Escalera profesional de aluminio de doble acceso - Soldadura Robótica. Peldaños Extra-anchos (120 mm) y bisagras de alta seguridad. Cintas de seguridad y tacos antideslizantes Extra.



ELITE

ESCADOTES
STEPLADDERS
ESCABEAUX
ESCALERAS DOMÉSTICAS

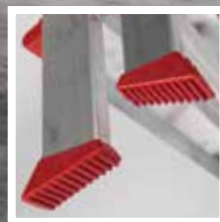
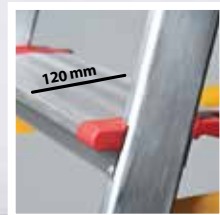

560 4620 024030	3	0,65 m	2,65 m	1,26 m	0,45 m	1,32 m	0,15 m	3,88 kg
560 4620 024047	4	0,89 m	2,89 m	1,50 m	0,48 m	1,58 m	0,15 m	4,70 kg
560 4620 024054	5	1,13 m	3,13 m	1,74 m	0,51 m	1,84 m	0,15 m	5,54 kg
560 4620 024061	6	1,37 m	3,37 m	1,98 m	0,53 m	2,10 m	0,15 m	6,52 kg
560 4620 024078	7	1,61 m	3,61 m	2,22 m	0,56 m	2,36 m	0,15 m	7,41 kg
560 4620 024085	8	1,85 m	3,85 m	2,46 m	0,58 m	2,62 m	0,15 m	8,42 kg

Escadote reforçado em alumínio. Plataforma ampla e antiderrapante (PVC) e degrau com 120 mm de largura. Cintas de segurança (6, 7 e 8 degraus) e pés antiderrapantes Elite.

Aluminium heavy-duty stepladder. Large non-slip platform (PVC) and deep tread aluminium steps (120 mm). Safety belts (6, 7 and 8 steps) and Elite slip-resistant feet.

Escabeau solide en aluminium. Large plateforme antidérapant (PVC) et marches extra-larges (120 mm). Sangles de sécurité (6, 7 et 8 marches) et sabot emboîtable antidérapant Elite.

Escalera de aluminio reforzada. Plataforma ancha antideslizante (PVC) y peldaños anchos (120 mm). Cintas de seguridad (6, 7 y 8 peldaños) y tacos antideslizantes Elite.



Opção PLUS
option | option | opción



SUPER
 ESCADOTES
 STEPLADDERS
 ESCABEAUX
 ESCALERAS DOMÉSTICAS



Barcode	Steps	Height	Width	Depth	Step Width	Step Depth	Step Height	Weight
560 4620 021039	3	0,60 m	2,60 m	1,21 m	0,41 m	1,32 m	0,14 m	3,47 kg
560 4620 021046	4	0,84 m	2,84 m	1,45 m	0,43 m	1,58 m	0,14 m	4,26 kg
560 4620 021053	5	1,08 m	3,08 m	1,69 m	0,46 m	1,84 m	0,14 m	5,06 kg
560 4620 021060	6	1,32 m	3,32 m	1,93 m	0,48 m	2,10 m	0,14 m	6,01 kg
560 4620 021077	7	1,56 m	3,56 m	2,17 m	0,51 m	2,36 m	0,14 m	6,87 kg
560 4620 021084	8	1,80 m	3,80 m	2,41 m	0,54 m	2,62 m	0,14 m	7,84 kg



Opção **ECO**
 option | option | opción

Escadote reforçado em alumínio. Plataforma antiderrapante com "click" de segurança e degrau com 120 mm de largura. Cintas de segurança (6, 7 e 8 degraus) e pés antiderrapantes.

Aluminium heavy-duty stepladder. Non-slip platform with safety lock and deep tread aluminium steps (120 mm). Safety belts (6, 7 and 8 steps) and slip-resistant feet.

Escabeau solide en aluminium. Plateforme antidérapant avec crochet de verrouillage et marches extra-larges (120 mm). Sangles de sécurité (6, 7 et 8 marches) et sabot emboitable antidérapant.

Escalera de alumínio reforçada. Plataforma com anclaje de seguridad y peldaños anchos (120 mm). Cintas de seguridad (6, 7 y 8 peldaños) y tacos antideslizantes.



CLASSIK

ESCADOTES
STEPLADDERS
ESCABEAUX
ESCALERAS DOMÉSTICAS



560 4620 024221	2	0,36 m	2,36 m	0,97 m	0,38 m	1,06 m	0,12 m	2,27 kg
560 4620 024238	3	0,60 m	2,60 m	1,21 m	0,41 m	1,32 m	0,12 m	2,82 kg
560 4620 024245	4	0,84 m	2,84 m	1,45 m	0,43 m	1,58 m	0,12 m	3,39 kg
560 4620 024252	5	1,08 m	3,08 m	1,69 m	0,46 m	1,84 m	0,12 m	3,98 kg
560 4620 024269	6	1,32 m	3,32 m	1,93 m	0,48 m	2,10 m	0,12 m	4,75 kg
560 4620 024276	7	1,56 m	3,56 m	2,17 m	0,51 m	2,36 m	0,12 m	5,67 kg
560 4620 024283	8	1,80 m	3,80 m	2,41 m	0,54 m	2,62 m	0,12 m	6,42 kg

Escadote em alumínio. Plataforma antiderrapante com “click” segurança, degraus estriados e arco de segurança. Cintas de segurança (6, 7 e 8 degraus) e pés antiderrapantes.

Aluminium stepladder. Non-slip platform with safety lock, ribbed steps and safety rail. Safety belts (6, 7 and 8 steps) and slip-resistant feet.

Escabeau en aluminium. Plateforme antidérapant avec crochet de verrouillage, marches striées et garde-corps. Sangles de sécurité (6, 7 et 8 marches) et sabot emboîtable antidérapant.

Escalera de aluminio. Plataforma con anclaje de seguridad, peldaños estriados y arco de seguridad. Cintas de seguridad (6, 7 y 8 peldaños) y tacos antideslizantes.



Opção ECO
option | option | opción



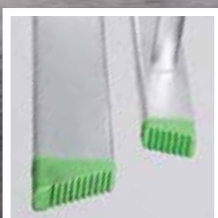

PLUS
 ESCADOTES
 STEPLADDERS
 ESCABEAUX
 ESCALERAS DOMÉSTICAS

Barcode	Steps	Height	Width	Depth	Step Width	Step Depth	Step Spacing	Weight
560 4620 022326	2	0,36 m	2,36 m	0,97 m	0,38 m	1,10 m	0,12 m	2,56 kg
560 4620 022333	3	0,60 m	2,60 m	1,21 m	0,41 m	1,36 m	0,12 m	3,17 kg
560 4620 022340	4	0,84 m	2,84 m	1,45 m	0,43 m	1,62 m	0,12 m	3,80 kg
560 4620 022357	5	1,08 m	3,08 m	1,69 m	0,46 m	1,88 m	0,12 m	4,44 kg
560 4620 022364	6	1,32 m	3,32 m	1,93 m	0,48 m	2,14 m	0,12 m	5,20 kg
560 4620 022371	7	1,56 m	3,56 m	2,17 m	0,51 m	2,40 m	0,12 m	6,16 kg
560 4620 022388	8	1,80 m	3,80 m	2,41 m	0,54 m	2,66 m	0,12 m	6,96 kg



Opção ECO
 option | option | opción

Escadote em alumínio com porta ferramentas. Degraus estriados antiderrapantes e arco de segurança. Cintas de segurança (6, 7 e 8 degraus) e pés antiderrapantes.

Aluminium stepladder with tool holder. Slip-resistant steps and safety rail. Safety belts (6, 7 and 8 steps) and slip-resistant feet.

Escabeau en aluminium avec porte-outils. Marches striées antidérapantes et garde-corps. Sangles de sécurité (6, 7 et 8 marches) et sabot emboîtable antidérapant.

Escalera de aluminio con porta-herramientas. Peldaños estriados para efecto antideslizante y arco de seguridad. Cintas de seguridad (6, 7 y 8 peldaños) y tacos antideslizantes.



DUPLO

ESCADOTES
STEPLADDERS
ESCABEAUX
ESCALERAS DOMÉSTICAS



560 4620 022531	3	0,14 m	2,14 m	0,65 m	0,41 m	0,70 m	0,16 m	2,87 kg
560 4620 022548	4	0,38 m	2,38 m	0,90 m	0,44 m	0,96 m	0,16 m	3,95 kg
560 4620 022555	5	0,62 m	2,62 m	1,14 m	0,46 m	1,22 m	0,16 m	4,89 kg
560 4620 022562	6	0,86 m	2,86 m	1,39 m	0,49 m	1,48 m	0,16 m	5,87 kg
560 4620 022579	7	1,10 m	3,10 m	1,63 m	0,51 m	1,74 m	0,16 m	6,86 kg
560 4620 022586	8	1,34 m	3,34 m	1,88 m	0,54 m	2,00 m	0,16 m	7,90 kg

Escadote em alumínio de duplo acesso. Degraus estriados e estabilidade reforçada. Cintas de segurança e pés antiderrapantes.

Aluminium double-sided stepladder. Ribbed steps and enhanced stability. Safety belts and slip-resistant feet.

Escabeau double accès en aluminium. Marches striées et stabilité renforcée. Sangles de sécurité et sabot emboîtable antidérapant.

Escala de aluminio de doble acceso. Peldaños estriados y estabilidad reforzada. Cintas de seguridad y tacos antideslizantes.



DELUX

ESCADOTES
STEPLADDERS
ESCABEAUX
ESCALERAS DOMÉSTICAS

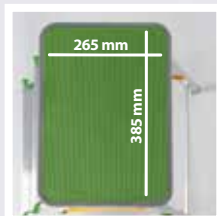

560 4620 002939



3



0,60 m



2,60 m



0,44 m



0,78 m



0,17 m



2,73 kg

Banco Escadote em alumínio. Plataforma ampla, facilidade de transporte e arrumação. Cintas de segurança e pés antiderrapantes.

Aluminium step stool. Large standing platform, easy transport and storage. Safety belts and slip-resistant feet.

Tabouret en aluminium. Large plateforme, transport et stockage aisé. Sangles de sécurité et sabot emboîtable antidérapant.

Taburete plegable ligero de aluminio. Plataforma ancha, fácil almacenamiento y transporte. Cintas de seguridad y tacos antideslizantes.

DOM

EN14183
EUROPEAN STANDARD



MASTER

ESCADOTES
STEPLADDERS
ESCABEAUX
ESCALERAS DOMÉSTICAS

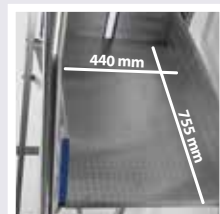

560 4620 000065	6	1,45 m	3,45 m	2,37 m	1,00 m	2,85 m	0,26 m	37,50 kg
560 4620 000089	8	1,95 m	3,95 m	2,87 m	1,00 m	3,41 m	0,26 m	41,00 kg
560 4620 000102	10	2,40 m	4,40 m	3,32 m	1,00 m	3,97 m	0,26 m	44,50 kg
560 4620 000126	12	2,90 m	4,90 m	3,82 m	1,20 m	4,53 m	0,26 m	51,50 kg

Plataforma de trabalho móvel em alumínio. Plataforma e degraus XL, porta ferramentas e corrimão de segurança. Facilidade de montagem e transporte. Ideal para utilização em armazéns.

Mobile aluminium working platform. XL platform and steps, tool holder and safety handrails. Easy assembly and transport. Ideal for use in warehouses.

Plate-forme individuelle roulante en aluminium. Plateforme et marches XL, porte-outils et rampes de sécurité. Montage et transport facile. Idéale pour une utilisation dans les entrepôts.

Plataforma de trabajo de aluminio móvil. Peldaños y plataforma XL, porta herramientas y pasamanos de seguridad. Facilidad de montaje y transporte. Ideal para uso en almacenes.



EXTRA PLUS

ESCADOTES
STEPLADDERS
ESCABEAUX
ESCALERAS DOMÉSTICAS



560 4620 021398



9



2,06 m



4,06 m



2,91 m



0,59 m



2,91 m



0,12 m



18,28 kg

Escadote móvel profissional em alumínio - Soldadura Robotizada. Fácil manuseamento. Degraus com largura Extra (120 mm), articulações de alta qualidade e porta ferramentas. Cintas de segurança e pés antiderrapantes Extra.

Easy slope aluminium mobile steps - Robotic Welding. Easy handling. Extra deep tread aluminum steps (120 mm), high quality hinges and tool holder. Safety belts and Extra slip-resistant feet.

Escabeau roulant repliable en aluminium - Soudage Robotique. Manipulation facile. Marches Extra-larges (120 mm), charnières de haute qualité et porte-outils. Sangles de sécurité et sabot emboîtable antidérapant Extra.

Escalera profesional desplazable (aluminio) - Soldadura Robótica. Fácil manipulación. Peldaños Extra-anchos (120 mm), bisagras de alta calidad y bandeja porta-herramientas. Cintas de seguridad y tacos antideslizantes Extra.



EXTRA LACADO

ESCADOTES
STEPLADDERS
ESCABEAUX
ESCALERAS DOMÉSTICAS



560 4620 023231	3	0,68 m	2,68 m	1,28 m	0,44 m	1,41 m	0,12 m	5,95 kg
560 4620 023248	4	0,91 m	2,91 m	1,51 m	0,47 m	1,66 m	0,12 m	7,17 kg
560 4620 023255	5	1,14 m	3,14 m	1,74 m	0,49 m	1,91 m	0,12 m	8,43 kg
560 4620 023262	6	1,37 m	3,37 m	1,97 m	0,52 m	2,16 m	0,12 m	9,99 kg
560 4620 023279	7	1,60 m	3,60 m	2,20 m	0,54 m	2,41 m	0,12 m	11,32 kg
560 4620 023286	8	1,83 m	3,83 m	2,43 m	0,57 m	2,66 m	0,12 m	12,68 kg
560 4620 023293	9	2,06 m	4,06 m	2,66 m	0,59 m	2,91 m	0,12 m	14,07 kg

Escadote profissional em alumínio - Soldadura Robotizada. Degraus com largura Extra (120 mm), articulações de alta qualidade e porta ferramentas. Cintas de segurança e pés antiderrapantes Extra.

Professional aluminium stepladder - Robotic Welding. Extra deep tread aluminum steps (120 mm), high quality hinges and tool holder. Safety belts and Extra slip-resistant feet.

Escabeau professionnel en aluminium - Soudage Robotique. Marches Extra-larges (120 mm), charnières de haute qualité et porte-outils. Sangles de sécurité et sabot emboîtable antidérapant Extra.

Escalera profesional de aluminio - Soldadura Robótica. Peldaños Extra-anchos (120 mm), bisagras de alta calidad y bandeja porta-herramientas. Cintas de seguridad y tacos antideslizantes Extra.



Opção
option | option | opción



DUO LACADO

ESCADOTES
STEPLADDERS
ESCABEAUX
ESCALERAS DOMÉSTICAS

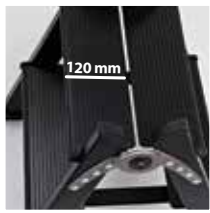

560 4620 023422	2	0,26 m	2,25 m	0,50 m	0,45 m	0,61 m	0,23 m	4,93 kg
560 4620 023439	3	0,26 m	2,49 m	0,74 m	0,47 m	0,86 m	0,23 m	6,77 kg
561 4620 023446	4	0,50 m	2,73 m	0,98 m	0,50 m	1,11 m	0,23 m	8,67 kg
562 4620 023453	5	0,74 m	2,97 m	1,22 m	0,52 m	1,36 m	0,23 m	10,65 kg
563 4620 023460	6	0,98 m	3,21 m	1,46 m	0,55 m	1,61 m	0,23 m	12,70 kg
564 4620 023477	7	1,22 m	3,45 m	1,70 m	0,57 m	1,86 m	0,23 m	14,81 kg
565 4620 023484	8	1,46 m	3,69 m	1,94 m	0,60 m	2,11 m	0,23 m	16,99 kg



Opção
option | option | opción

Escadote profissional de duplo acesso em alumínio - Soldadura Robotizada. Degraus Extra com 120 mm de largura e articulações de segurança. Cintas de segurança e pés antiderrapantes Extra.

Professional aluminium double-sided stepladder - Robotic Welding. Extra deep tread aluminum steps (120 mm) and safety hinges. Safety belts and Extra slip-resistant feet.

Escabeau professionnel double accès en aluminium - Soudage Robotique. Marches Extra-larges (120 mm) et charnières de sécurité. Sangles de sécurité et sabot emboitable antidérapant Extra.

Escalera profesional de aluminio de doble acceso - Soldadura Robótica. Peldaños Extra-anchos (120 mm) y bisagras de alta seguridad. Cintas de seguridad y tacos antideslizantes Extra.



TRICOLOR

ESCADOTES
STEPLADDERS
ESCABEAUX
ESCALERAS DOMÉSTICAS

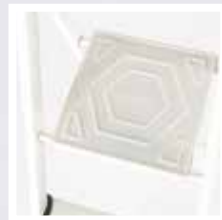

560 4620 021220	2	0,36 m	2,36 m	0,97 m	0,38 m	1,06 m	0,12 m	2,27 kg
560 4620 021237	3	0,60 m	2,60 m	1,21 m	0,41 m	1,32 m	0,12 m	2,82 kg
560 4620 021244	4	0,84 m	2,84 m	1,45 m	0,43 m	1,58 m	0,12 m	3,39 kg
560 4620 021251	5	1,08 m	3,08 m	1,69 m	0,46 m	1,84 m	0,12 m	3,98 kg
560 4620 021268	6	1,32 m	3,32 m	1,93 m	0,48 m	2,10 m	0,12 m	4,75 kg
561 4620 021275	7	1,56 m	3,56 m	2,17 m	0,51 m	2,36 m	0,12 m	5,67 kg
562 4620 021282	8	1,80 m	3,80 m	2,41 m	0,54 m	2,62 m	0,12 m	6,42 kg

Escadote em alumínio. Plataforma antiderrapante com “click” segurança, degraus estriados e arco de segurança. Cintas de segurança (6, 7 e 8 degraus) e pés antiderrapantes.

Aluminium stepladder. Non-slip platform with safety lock, ribbed steps and safety rail. Safety belts (6, 7 and 8 steps) and slip-resistant feet.

Escabeau en aluminium. Plateforme antidérapant avec crochet de verrouillage, marches striées et garde-corps. Sangles de sécurité (6, 7 et 8 marches) et sabot emboitable antidérapant.

Escalera de aluminio. Plataforma con anclaje de seguridad, peldaños estriados y arco de seguridad. Cintas de seguridad (6, 7 y 8 peldaños) y tacos antideslizantes.



Opção
option | option | opción



CONFORTO

ESCADOTES
STEPLADDERS
ESCABEAUX
ESCALERAS DOMÉSTICAS



560 4620 025129

2

0,47 m

2,47 m

0,87 m

0,48 m

0,95 m

0,09 m

4,70 kg

560 4620 025136

3

0,72 m

2,72 m

1,12 m

0,48 m

1,22 m

0,09 m

6,50 kg

560 4620 025143

4

0,97 m

2,97 m

1,37 m

0,48 m

1,49 m

0,09 m

8,50 kg

Escadote extra-largo com arco de segurança. Plataformas alargadas antiderrapantes.

Extra-large folding stepladder with safety rail. Large non-slip rubber steps.

Marchepied extra-large avec garde corps. Marches de grande dimension avec tapis antidérapants.

Escalera extra-ancha con arco de seguridad. Peldaños anchos antideslizantes.

DOM

EN131
EUROPEAN STANDARD



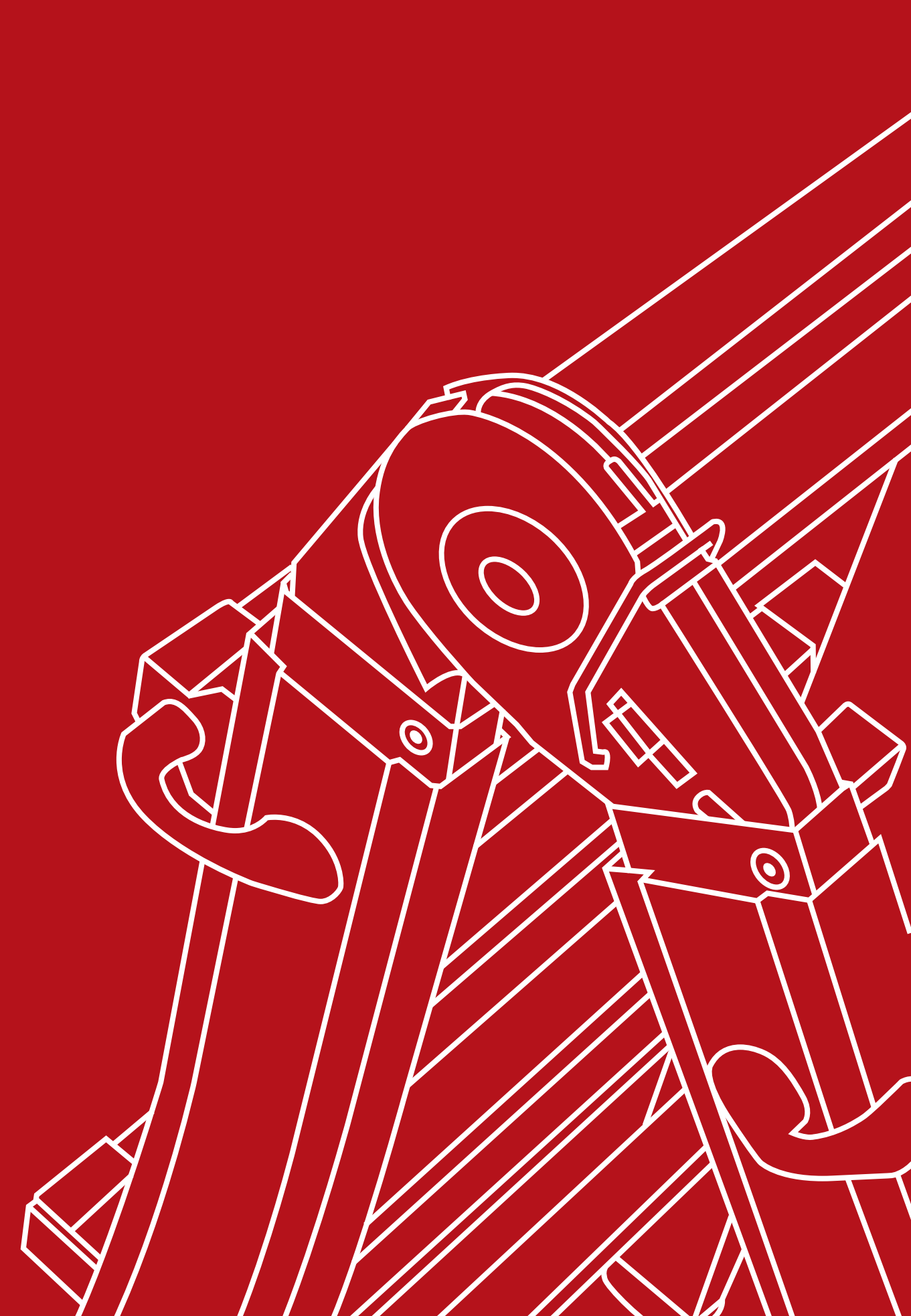



ARTICULADA TELESCÓPICA

ESCADAS MULTIFUNÇÕES
MULTI-PURPOSE LADDERS
ÉCHELLES MULTIFONCTIONS
ESCALERAS MULTIFUNCIÓN

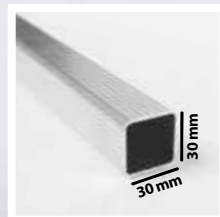
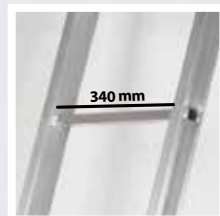

560 4620 001345	3+3	2,89 m	2,79 m	3,84 m	1,42 m	2,73 m	0,61 m	0,94 m	0,22 m	9,49 kg
560 4620 001352	3+4	3,45 m	3,33 m	4,38 m	1,68 m	3,00 m	0,61 m	1,22 m	0,22 m	10,84 kg
560 4620 001369	4+4	4,01 m	3,87 m	4,92 m	1,94 m	3,28 m	0,61 m	1,22 m	0,22 m	12,12 kg
560 4620 001376	4+5	4,57 m	4,41 m	5,46 m	2,20 m	3,55 m	0,61 m	1,50 m	0,22 m	13,08 kg

Escada articulada telescópica em alumínio. Articulações Multiusos e sistema de bloqueio da parte deslizante. Permite utilização em superfícies desniveladas.

Aluminium multi-purpose telescopic ladder. Multiusos hinges and sliding mechanism with locks. Adjustable on uneven surfaces.

Échelle pliante télescopique en aluminium. Articulation multiusos et système de blocage du plan coulissant. Facile à utiliser sur des hauteurs inégales.

Escalera telescópica multifunción de aluminio. Bisagras Multiusos y sistema de posicionamiento con agarre. Ideal para trabajos en desnivel.

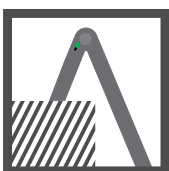
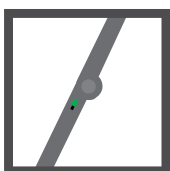
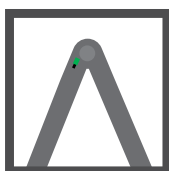
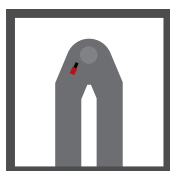

MULTIUSOS

ESCADAS MULTIFUNÇÕES
MULTI-PURPOSE LADDERS
ÉCHELLES MULTIFONCTIONS
ESCALERAS MULTIFUNCIÓN

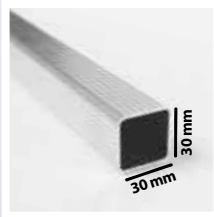
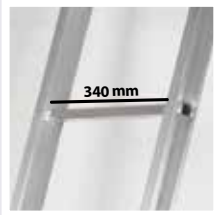

560 4620 013218	4x3	3,60 m	3,48 m	4,42 m	1,76 m	3,10 m	1,00 m	3,00 m	0,39 m	0,97 m	0,28 m	13,40 kg
560 4620 013225	4x4	4,70 m	4,54 m	5,51 m	2,30 m	3,64 m	-	-	0,39 m	1,25 m	0,28 m	15,30 kg

Escada multifunções em alumínio. Articulações Multiusos com bloqueio automático e barra estabilizadora.

Aluminium multi-purpose ladder. Multiusos Hinge with locking mechanism and stabilizer bar.

Échelle multi positions en aluminium. Articulation Multiusos avec système de blocage et barre stabilisatrice.

Escalera multifuncional de aluminio. Bisagras Multiusos con sistema de bloqueo y barra estabilizadora.

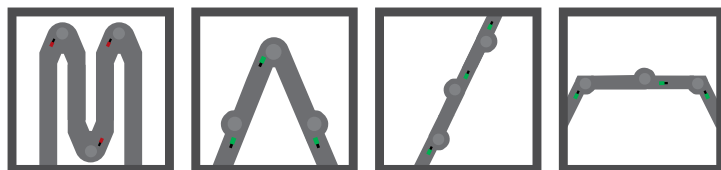
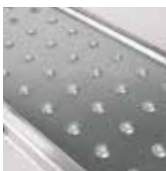

Opção
option | option | opción



MULTIUSOS CLASSIK

ESCADAS MULTIFUNÇÕES
MULTI-PURPOSE LADDERS
ÉCHELLES MULTIFONCTIONS
ESCALERAS MULTIFUNCIÓN

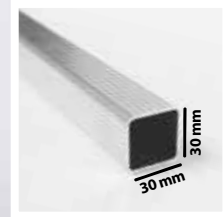
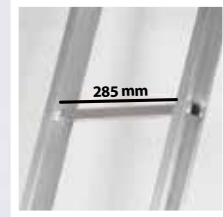

5604620 021510 4x3 3,49 m 3,37 m 4,39 m 1,70 m 3,02 m 0,93 m 2,93 m 0,33 m 0,95 m 0,26 m 11,62 kg

Escada multifunções em alumínio. Articulações Classik com bloqueio automático e barra estabilizadora.

Aluminium multi-purpose ladder. Classik Hinge with locking mechanism and stabilizer bar.

Échelle multi positions en aluminium. Articulation Classik avec système de blocage et barre stabilisatrice.

Escalera multifuncional de aluminio. Bisagras Classik con sistema de bloqueo y barra estabilizadora.

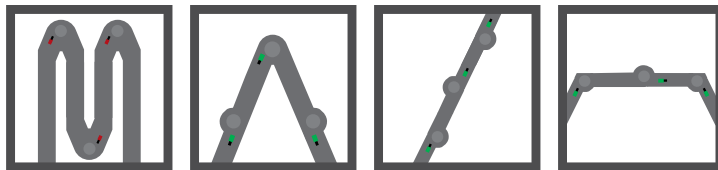
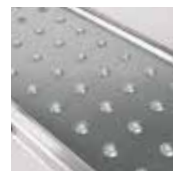

Opção
option | option | opción



TRANSFORMÁVEL

ESCADAS MULTIFUNÇÕES
MULTI-PURPOSE LADDERS
ÉCHELLES MULTIFONCTIONS
ESCALERAS MULTIFUNCIÓN

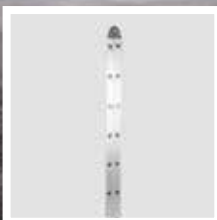
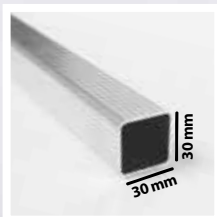
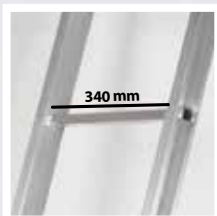

560 4620 021428

7+7

3,98 m

3,84 m

4,92 m

1,92 m

3,27 m

0,39 m

2,00 m

0,14 m

10,26 kg

560 4620 021527

8+8

4,54 m

4,39 m

5,46 m

2,18 m

3,54 m

0,39 m

2,28 m

0,14 m

11,23 kg

Escada articulada em alumínio. Articulações Multiusos e barra estabilizadora.

Aluminium folding ladder. Multiusos hinges and stabilizer bar.

Échelle articulée en aluminium. Articulation Multiusos et barre stabilisatrice.

Escala articulada de aluminio. Bisagras Multiusos y barra estabilizadora.



Opção
option | option | opción

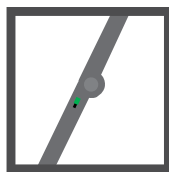
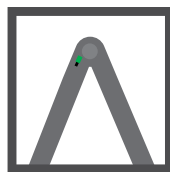
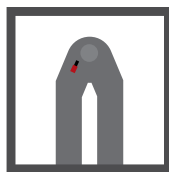

BANCADA TELESCÓPICA

ESCADAS MULTIFUNÇÕES
MULTI-PURPOSE LADDERS
ÉCHELLES MULTIFONCTIONS
ESCALERAS MULTIFUNCIÓN

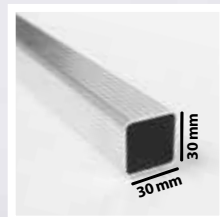
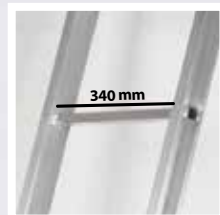

5604620 001406 18 4,60 m 4,44 m 5,46 m 2,18 m 3,55 m 1,45 m 3,45 m 0,61 m 0,94 m 0,35 m 20,59 kg

Bancada de trabalho telescópica em alumínio. Articulações Multiusos e sistema de bloqueio da parte deslizante. Permite utilização em superfícies desniveladas.

Aluminium telescopic work platform. Multiusos hinges and sliding mechanism with locks. Adjustable on uneven surfaces.

Plate forme de travail télescopique en aluminium. Articulation Multiusos et système de blocage du plan coulissant. Facile à utiliser sur des hauteurs inégales.

Plataforma de trabajo telescópica de aluminio. Bisagras Multiusos y sistema de posicionamiento con agarre. Ideal para trabajos en desnivel.

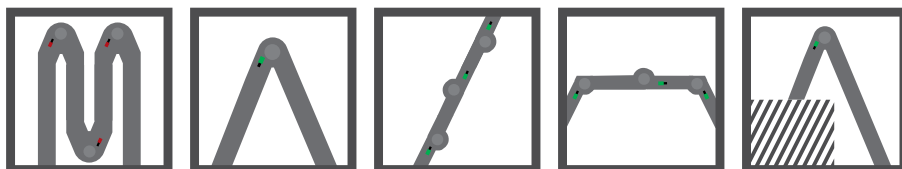

ARTICULADA TELESCÓPICA (FERRO)

ESCADAS MULTIFUNÇÕES
MULTI-PURPOSE LADDERS
ÉCHELLES MULTIFONCTIONS
ESCALERAS MULTIFUNCIÓN



560 4620 004407



4+4



3,71 m



3,58 m



4,64 m



1,81 m



3,16 m



0,52 m



1,15 m



0,15 m



14,80 kg

Escada articulada telescópica em ferro. Sistema de bloqueio da parte deslizante. Permite utilização em superfícies desniveladas.

Steel multi-purpose telescopic ladder. Sliding mechanism with locks. Adjustable on uneven surfaces.

Échelle pliante télescopique en acier. Système de blocage du plan coulissant. Facile à utiliser sur des hauteurs inégales.

Escalera telescópica multifunción de acero. Sistema de posicionamiento con agarre. Ideal para trabajos en desnivel.



TELESCÓPICA

ESCADAS MULTIFUNÇÕES
 MULTI-PURPOSE LADDERS
 ÉCHELLES MULTIFONCTIONS
 ESCALERAS MULTIFUNCIÓN

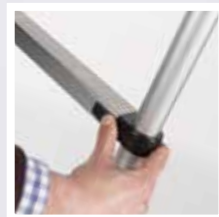

560 4620 001383

9

2,61 m

2,52 m

3,65 m

0,45 m

0,74 m

0,07 m

0,77 x 0,49 x 0,09 m

6,70 kg

560 4620 001390

13

3,81 m

3,68 m

4,81 m

0,47 m

0,86 m

0,09 m

0,89 x 0,52 x 0,10 m

10,70 kg

Escada telescópica em alumínio. Facilidade de transporte e arrumação.

Aluminium telescopic ladder. Easy transport and storage.

Échelle télescopique en aluminium. Transporte et stockage aisé.

Escalera telescópica de aluminio. Fácil transporte y almacenamiento.



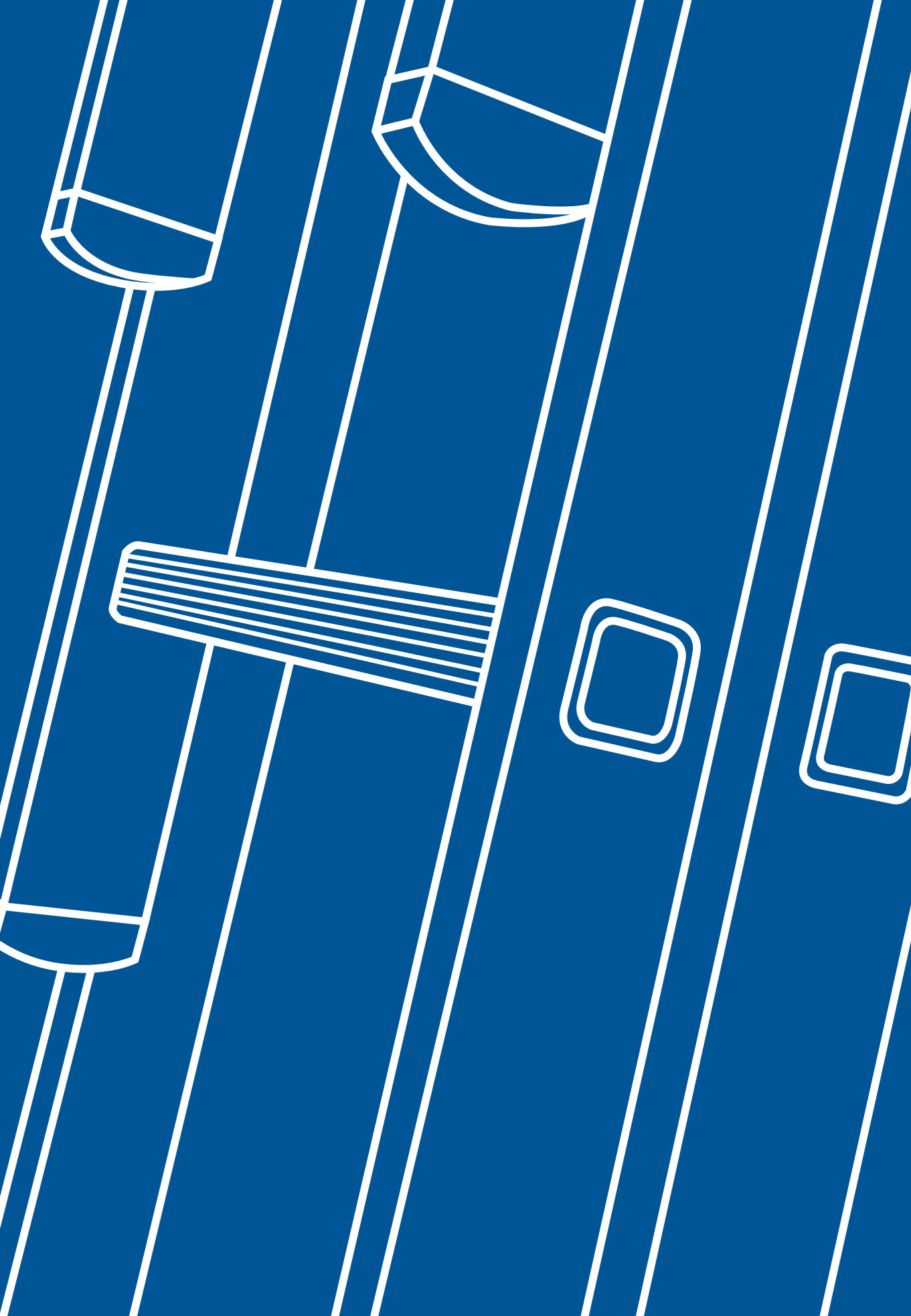

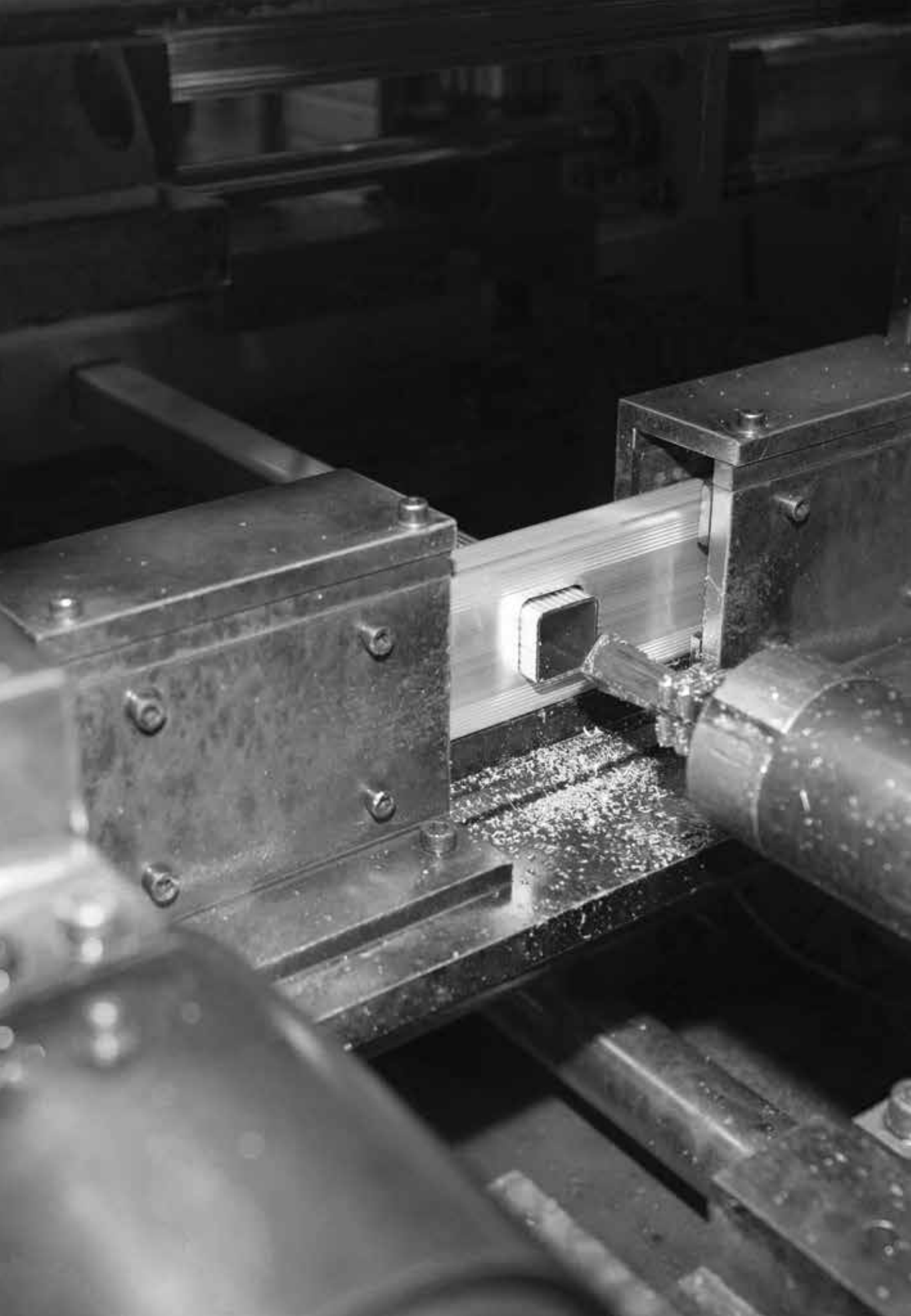

SIMPLES

ESCADAS
LADDERS
ÉCHELLES
ESCALERAS INDUSTRIALES

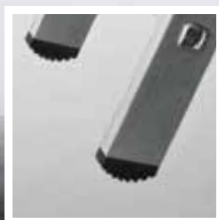
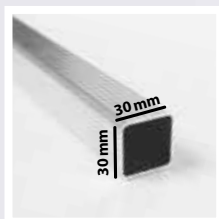

REF.										
2.00	560 4620 620003	7	2,03 m	1,96 m	2,99 m	0,35 m	0,07 m	67 mm	3,55 kg	
2.50	560 4620 625008	9	2,59 m	2,50 m	3,54 m	0,35 m	0,07 m	67 mm	4,48 kg	
3.00	560 4620 630002	10	2,96 m	2,86 m	3,81 m	0,35 m	0,07 m	67 mm	5,04 kg	
3.50	560 4620 635007	12	3,46 m	3,34 m	4,35 m	0,35 m	0,07 m	67 mm	6,82 kg	
4.00	560 4620 640001	14	4,00 m	3,86 m	4,89 m	0,35 m	0,07 m	67 mm	7,76 kg	
5.00	560 4620 650000	17	4,91 m	4,74 m	5,70 m	0,35 m	0,07 m	67 mm	9,30 kg	
6.00	560 4620 660009	21	6,01 m	5,80 m	6,78 m	0,35 m	0,07 m	67 mm	11,21 kg	



Opção
option | option | opción

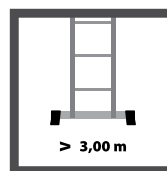
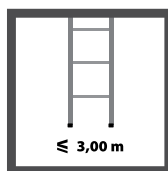

Escada simples em alumínio.

Aluminium single ladder.

Échelle simple en aluminium.

Escalera de aluminio simple.



DUPLA

ESCADAS
LADDERS
ÉCHELLES
ESCALERAS INDUSTRIALES

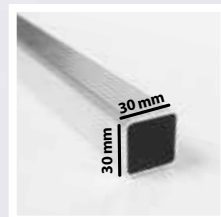

REF.



2.00	560 4620 602009	7+7	3,44 m	3,32 m	4,35 m	2,03 m	1,96 m	3,27 m	0,40 m	0,12 m	67 mm	8,49 kg
2.50	560 4620 602504	9+9	4,56 m	4,40 m	5,43 m	2,59 m	2,50 m	3,81 m	0,40 m	0,12 m	67 mm	10,46 kg
3.00	560 4620 603006	10+10	5,21 m	5,03 m	5,97 m	2,96 m	2,86 m	4,08 m	0,40 m	0,12 m	67 mm	11,65 kg
3.50	560 4620 603501	12+12	5,99 m	5,78 m	6,79 m	3,46 m	3,34 m	4,62 m	0,40 m	0,12 m	67 mm	13,99 kg
4.00	560 4620 604003	14+14	6,81 m	6,57 m	7,60 m	4,00 m	3,86 m	5,16 m	0,40 m	0,12 m	67 mm	15,93 kg
5.00	560 4620 730504	17+17	8,56 m	8,26 m	9,22 m	4,91 m	4,74 m	5,97 m	0,40 m	0,13 m	73 mm	20,43 kg
6.00	560 4620 706004	21+21	10,78 m	10,41 m	11,38 m	6,01 m	5,80 m	7,05 m	0,40 m	0,14 m	80 mm	27,34 kg

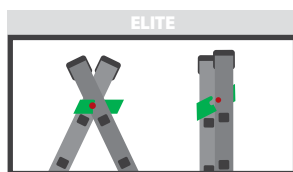
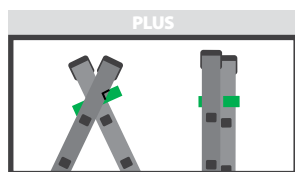

Escada de 2 lances transformável em alumínio.

Aluminium 2 section transformable ladder.

Échelle transformable 2 plans en aluminium.

Escala transformable de 2 tramos de aluminio.

Opção

option | option | opción



TRIPLA

ESCADAS
LADDERS
ÉCHELLES
ESCALERAS INDUSTRIALES

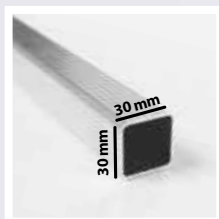

REF.	Barcode	Staircase Icon	Lightning Bolt Icon	Lightning Bolt Icon	Lightning Bolt Icon	Step Icon	Step Icon	Step Icon	Step Icon	Step Icon	Step Icon	Step Icon	Step Icon
2.00	560 4620 600203	7+7+7	4,84 m	4,67 m	5,71 m	3,44 m	3,32 m	4,08 m	0,46 m	0,16 m	67 mm	12,40 kg	
2.50	560 4620 600258	9+9+9	6,24 m	6,03 m	7,06 m	4,56 m	4,40 m	5,16 m	0,46 m	0,16 m	67 mm	15,25 kg	
3.00	560 4620 600302	10+10+10	7,17 m	6,92 m	7,87 m	5,21 m	5,03 m	5,70 m	0,46 m	0,16 m	67 mm	17,19 kg	
3.50	560 4620 733505	12+12+12	8,23 m	7,95 m	8,95 m	5,99 m	5,78 m	6,51 m	0,46 m	0,18 m	73 mm	21,64 kg	
4.00	560 4620 734007	14+14+14	9,61 m	9,28 m	10,31 m	6,81 m	6,57 m	7,33 m	0,46 m	0,18 m	73 mm	24,68 kg	
5.00	560 4620 700507	17+17+17	12,20 m	11,78 m	12,74 m	8,56 m	8,26 m	8,95 m	0,46 m	0,19 m	80 mm	33,21 kg	
6.00	560 4620 900068	21+21+21	15,54 m	15,01 m	15,98 m	10,78 m	10,41 m	11,11 m	0,46 m	0,21 m	90 mm	42,82 kg	



Opção
option | option | opción

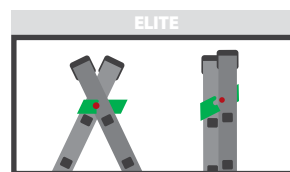
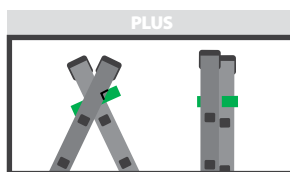

Escada de 3 lances transformável em alumínio.
Aluminium 3 section transformable ladder.
Échelle transformable 3 plans en aluminium.
Escalera transformable de 3 tramos de aluminio.



CORDA DUPLA

ESCADAS
LADDERS
ÉCHELLES
ESCALERAS INDUSTRIALES

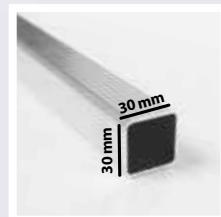
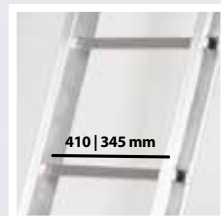

REF.	Barcode	Staircase Icon	Icon 1	Icon 2	Icon 3	Icon 4	Icon 5	Icon 6	Icon 7
2.00	560 4620 627026	7+7	3,44 m	3,32 m	4,35 m	0,40 m	0,12 m	67 mm	9,56 kg
2.50	560 4620 627255	9+9	4,56 m	4,40 m	5,43 m	0,40 m	0,12 m	67 mm	11,58 kg
3.00	560 4620 627033	10+10	5,21 m	5,03 m	5,97 m	0,40 m	0,12 m	67 mm	13,00 kg
3.50	560 4620 627354	12+12	5,99 m	5,78 m	6,79 m	0,40 m	0,12 m	67 mm	15,19 kg
4.00	560 4620 627040	14+14	6,81 m	6,57 m	7,60 m	0,40 m	0,12 m	67 mm	17,18 kg
5.00	560 4620 728051	17+17	8,56 m	8,26 m	9,22 m	0,40 m	0,14 m	80 mm	24,06 kg
6.00	560 4620 728068	21+21	10,78 m	10,41 m	11,38 m	0,40 m	0,14 m	80 mm	28,78 kg

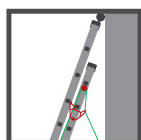
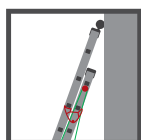

Escada de 2 lances extensível com corda em alumínio.

Aluminium 2 section extension ladder - rope operated.

Échelle à coulisse à corde 2 plans en aluminium.

Escalera extensible 2 tramos con cuerda de aluminio.

Opção
option | option | opción



CORDA TRIPLA

ESCADAS
LADDERS
ÉCHELLES
ESCALERAS INDUSTRIALES

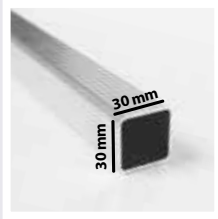

REF.	Barcode	Staircase Icon	Lightning Bolt Icon	Lightning Bolt Icon	Lightning Bolt Icon	Ladder Icon	Ladder Icon	Ladder Icon	Person Icon
2.00	560 4620 276026	7+7+7	4,84 m	4,67 m	5,71 m	0,46 m	0,16 m	67 mm	13,48 kg
2.50	560 4620 276255	9+9+9	6,24 m	6,03 m	7,06 m	0,46 m	0,16 m	67 mm	16,38 kg
3.00	560 4620 276033	10+10+10	7,17 m	6,92 m	7,87 m	0,46 m	0,16 m	67 mm	18,33 kg
3.50	560 4620 287350	12+12+12	8,23 m	7,95 m	8,95 m	0,46 m	0,19 m	80 mm	25,42 kg
4.00	560 4620 287046	14+14+14	9,61 m	9,28 m	10,31 m	0,46 m	0,19 m	80 mm	28,83 kg
5.00	560 4620 287053	17+17+17	12,20 m	11,78 m	12,74 m	0,46 m	0,19 m	80 mm	34,58 kg
6.00	560 4620 920066	21+21+21	15,54 m	15,01 m	15,98 m	0,46 m	0,21 m	90 mm	44,25 kg



Opção
option | option | opción

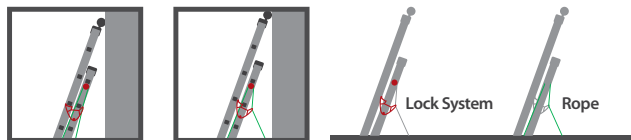

Escada de 3 lances extensível com corda em alumínio.

Aluminium 3 section extension ladder - rope operated.

Échelle à coulisse à corde 3 plans en aluminium.

Escala extensible 3 tramos con cuerda de aluminio.



CLASSIK SIMPLES

ESCADAS
LADDERS
ÉCHELLES
ESCALERAS INDUSTRIALES

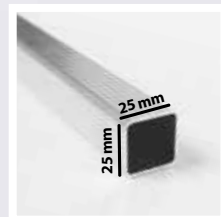
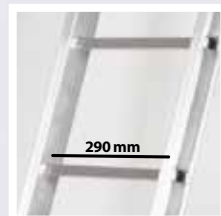

REF.	Barcode	Stairs Icon	Side Rail Icon	Side Rail Icon	Height Icon	Width Icon	Foot Icon	Foot Icon	Weight Icon
2.00	560 4620 432002	7	2,03 m	1,96 m	2,99 m	0,34 m	0,06 m	58 mm	3,06 kg
2.50	560 4620 432057	9	2,59 m	2,50 m	3,54 m	0,34 m	0,06 m	58 mm	3,84 kg
3.00	560 4620 433009	10	2,96 m	2,86 m	3,81 m	0,34 m	0,06 m	58 mm	4,33 kg
3.50	560 4620 433054	12	3,46 m	3,34 m	4,35 m	0,34 m	0,06 m	58 mm	5,58 kg
4.00	560 4620 434006	14	4,00 m	3,86 m	4,89 m	0,34 m	0,06 m	58 mm	6,36 kg

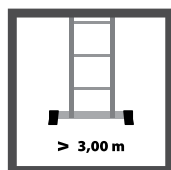
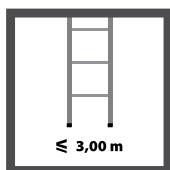

Escada simples em alumínio para utilização bricolage.

Aluminium single ladder for DIY use.

Échelle simple en aluminium pour une utilisation bricolage.

Escalera de aluminio simple para bricolage.

Opção
option | option | opción



CLASSIK DUPLA

ESCADAS
LADDERS
ÉCHELLES
ESCALERAS INDUSTRIALES

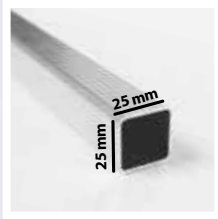

REF.	Barcode	Stairs	Icon 1	Icon 2	Icon 3	Icon 4	Icon 5	Icon 6	Icon 7	Icon 8	Icon 9	Icon 10	Icon 11	Icon 12
2.00	560 4620 432200	7+7	3,44 m	3,32 m	4,35 m	2,03 m	1,96 m	3,27 m	0,41 m	0,10 m	58 mm	7,27 kg		
2.50	560 4620 432507	9+9	4,28 m	4,13 m	5,16 m	2,59 m	2,50 m	3,81 m	0,41 m	0,10 m	58 mm	8,93 kg		
3.00	560 4620 433306	10+10	4,93 m	4,76 m	5,70 m	2,96 m	2,86 m	4,08 m	0,41 m	0,10 m	58 mm	9,95 kg		
3.50	560 4620 433504	12+12	5,71 m	5,51 m	6,51 m	3,46 m	3,34 m	4,62 m	0,41 m	0,12 m	67 mm	12,48 kg		

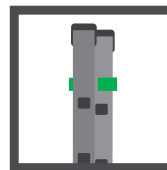

Opção
option | option | opción

Escada de 2 lances transformável em alumínio para utilização bricolage.

Aluminium 2 section transformable ladder for DIY use.

Échelle transformable 2 plans en aluminium pour une utilisation bricolage.

Escala transformable de 2 tramos de aluminio para bricolaje.



CLASSIK TRIPLA

ESCADAS
LADDERS
ÉCHELLES
ESCALERAS INDUSTRIALES

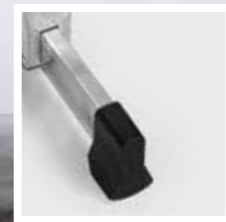
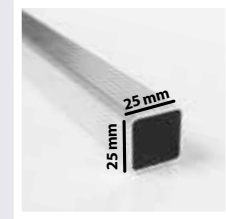

REF.



2.00	560 4620 432224	7+7+7	4,28 m	4,13 m	5,17 m	3,16 m	3,05 m	3,81 m	0,47 m	0,14 m	58 mm	11,13 kg
2.50	560 4620 432255	9+9+9	5,40 m	5,22 m	6,25 m	4,00 m	3,86 m	4,62 m	0,47 m	0,14 m	58 mm	13,68 kg
3.00	560 4620 433337	10+10+10	6,33 m	6,11 m	7,06 m	4,65 m	4,49 m	5,16 m	0,47 m	0,16 m	67 mm	16,36 kg

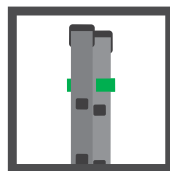
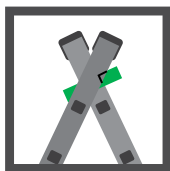

Escada de 3 lances transformável em alumínio para utilização bricolage.

Aluminium 3 section transformable ladder for DIY use.

Échelle transformable 3 plans en aluminium pour une utilisation bricolage.

Escalera transformable de 3 tramos de aluminio para bricolaje.

Opção
option | option | opción



ELECTRA DUPLA

ESCADAS
LADDERS
ÉCHELLES
ESCALERAS INDUSTRIALES

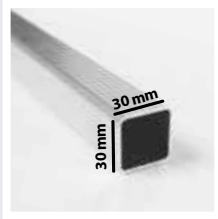

REF.	Barcode	Stairs	1	2	3	4	5	6	7	8	9	10	11	12
2.00	560 4620 802003	7+7	3,44 m	3,32 m	4,35 m	2,03 m	1,96 m	3,27 m	0,40 m	0,12 m	67 mm	10,22 kg		
2.50	560 4620 802508	9+9	4,56 m	4,40 m	5,43 m	2,59 m	2,50 m	3,81 m	0,40 m	0,12 m	67 mm	12,56 kg		
3.00	560 4620 803000	10+10	5,21 m	5,03 m	5,97 m	2,96 m	2,86 m	4,08 m	0,40 m	0,12 m	67 mm	14,00 kg		
3.50	560 4620 803505	12+12	5,99 m	5,78 m	6,79 m	3,46 m	3,34 m	4,62 m	0,40 m	0,12 m	67 mm	16,43 kg		
4.00	560 4620 804007	14+14	6,81 m	6,57 m	7,60 m	4,00 m	3,86 m	5,16 m	0,40 m	0,12 m	67 mm	18,70 kg		

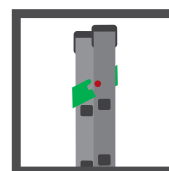
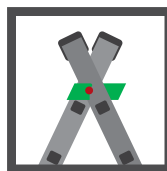

Opção
option | option | opción

Escada de 2 lances transformável em alumínio e fibra de vidro.

Aluminium and fiberglass 2 section transformable ladder.

Échelle transformable 2 plans en aluminium et fibre de verre.

Escalera transformable de 2 tramos de aluminio y fibra de vidrio.



ELECTRA TRIPLA

ESCADAS
LADDERS
ÉCHELLES
ESCALERAS INDUSTRIALES

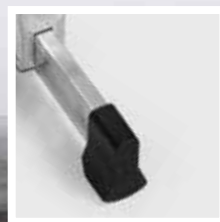
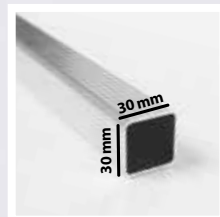

REF.	Barcode	Staircase Icon	Lightning Bolt Icon	Lightning Bolt Icon	Lightning Bolt Icon	Step Icon	Step Icon	Step Icon	Step Icon	Step Icon	Step Icon	Step Icon	Step Icon
2.00	560 4620 800207	7+7+7	4,84 m	4,67 m	5,71 m	3,44 m	3,32 m	4,08 m	0,46 m	0,16 m	67 mm	13,97 kg	
2.50	560 4620 800252	9+9+9	6,24 m	6,03 m	7,06 m	4,56 m	4,40 m	5,16 m	0,46 m	0,16 m	67 mm	17,19 kg	
3.00	560 4620 800306	10+10+10	7,17 m	6,92 m	7,87 m	5,21 m	5,03 m	5,70 m	0,46 m	0,16 m	67 mm	19,38 kg	
3.50	560 4620 733352	12+12+12	8,23 m	7,95 m	8,95 m	5,99 m	5,78 m	6,51 m	0,46 m	0,17 m	73 67 mm	23,50 kg	
4.00	560 4620 734441	14+14+14	9,61 m	9,28 m	10,31 m	6,81 m	6,57 m	7,33 m	0,46 m	0,17 m	73 67 mm	26,80 kg	
5.00	560 4620 900501	17+17+17	12,20 m	11,78 m	12,74 m	8,56 m	8,26 m	8,95 m	0,46 m	0,18 m	80 67 mm	34,59 kg	

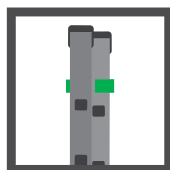
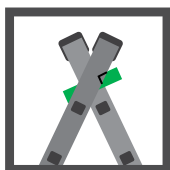

Escada de 3 lances transformável em alumínio e fibra de vidro.

Aluminium and fiberglass 3 section transformable ladder.

Échelle transformable 3 plans en aluminium et fibre de verre.

Escalera transformable de 3 tramos de aluminio y fibra de vidrio.

Opção
option | option | opción



ELECTRA CORDA DUPLA

ESCADAS
LADDERS
ÉCHELLES
ESCALERAS INDUSTRIALES

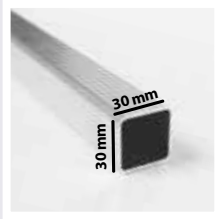

REF.	Barcode	Icon 1	Icon 2	Icon 3	Icon 4	Icon 5	Icon 6	Icon 7	Icon 8	Icon 9
2.00	560 4620 180200	7+7	3,44 m	3,32 m	4,35 m	0,40 m	0,12 m	67 mm	10,96 kg	
2.50	560 4620 180255	9+9	4,56 m	4,40 m	5,43 m	0,40 m	0,12 m	67 mm	13,35 kg	
3.00	560 4620 180309	10+10	5,21 m	5,03 m	5,97 m	0,40 m	0,12 m	67 mm	14,81 kg	
3.50	560 4620 180354	12+12	5,99 m	5,78 m	6,79 m	0,40 m	0,12 m	67 mm	17,29 kg	
4.00	560 4620 180408	14+14	6,81 m	6,57 m	7,60 m	0,40 m	0,12 m	67 mm	19,60 kg	
5.00	560 4620 190506	17+17	8,56 m	8,26 m	9,22 m	0,40 m	0,13 m	80 67 mm	25,28 kg	
6.00	560 4620 190605	21+21	10,78 m	10,41 m	11,38 m	0,40 m	0,13 m	80 67 mm	30,30 kg	



Opção
option | option | opción

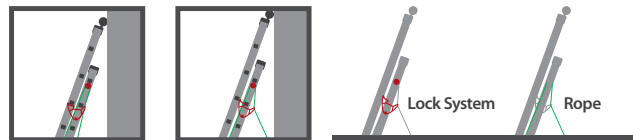

Escada de 2 lances extensível com corda em alumínio e fibra de vidro.

Aluminium and fiberglass 2 section extension ladder - rope operated.

Échelle à coulisse à corde 2 plans en aluminium et fibre de verre.

Escalera extensible 2 tramos con cuerda de aluminio y fibra de vidrio.



ELECTRA CORDA TRIPLA

ESCADAS
LADDERS
ÉCHELLES
ESCALERAS INDUSTRIALES

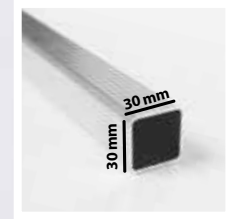

REF.	Barcode	Staircase Icon	Lightning Bolt Icon	Lightning Bolt Icon	Lightning Bolt Icon	Ladder Icon	Foot Icon	Foot Icon	Weight Icon
2.00	560 4620 000829	7+7+7	4,84 m	4,67 m	5,71 m	0,46 m	0,16 m	67 mm	15,05 kg
2.50	560 4620 008252	9+9+9	6,24 m	6,03 m	7,06 m	0,46 m	0,16 m	67 mm	18,32 kg
3.00	560 4620 000836	10+10+10	7,17 m	6,92 m	7,87 m	0,46 m	0,16 m	67 mm	20,52 kg
3.50	560 4620 009358	12+12+12	8,23 m	7,95 m	8,95 m	0,46 m	0,18 m	80 67 mm	26,41 kg
4.00	560 4620 000942	14+14+14	9,61 m	9,28 m	10,31 m	0,46 m	0,18 m	80 67 mm	29,97 kg
5.00	560 4620 000959	17+17+17	12,20 m	11,78 m	12,74 m	0,46 m	0,18 m	80 67 mm	35,96 kg

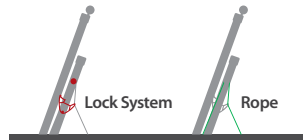
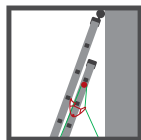
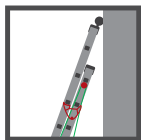

Escada de 3 lances extensível com corda em alumínio e fibra de vidro.

Aluminium and fiberglass 3 section extension ladder - rope operated.

Échelle à coulisse à corde 3 plans en aluminium et fibre de verre.

Escalera extensible 3 tramos con cuerda de aluminio y fibra de vidrio.

Opção
option | option | opción



FIBRA SIMPLES

ESCADAS
LADDERS
ÉCHELLES
ESCALERAS INDUSTRIALES

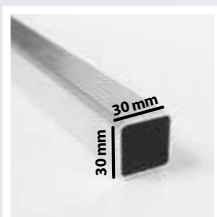

REF.									
2.00	560 4620 820007	7	2,03 m	1,96 m	2,99 m	0,35 m	0,07 m	67 mm	4,92 kg
2.50	560 4620 825002	9	2,59 m	2,50 m	3,54 m	0,35 m	0,07 m	67 mm	6,22 kg
3.00	560 4620 830006	10	2,96 m	2,86 m	3,81 m	0,35 m	0,07 m	67 mm	7,03 kg
3.50	560 4620 835001	12	3,46 m	3,34 m	4,35 m	0,35 m	0,07 m	67 mm	8,91 kg
4.00	560 4620 840005	14	4,00 m	3,86 m	4,89 m	0,35 m	0,07 m	67 mm	10,18 kg
5.00	560 4620 850004	17	4,91 m	4,74 m	5,70 m	0,35 m	0,07 m	67 mm	12,26 kg
6.00	560 4620 860003	21	6,01 m	5,80 m	6,78 m	0,35 m	0,07 m	67 mm	14,82 kg

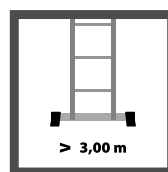
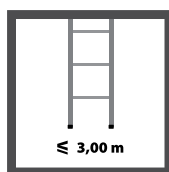

Opção
option | option | opción

Escada simples em fibra de vidro.

Fiberglass single ladder.

Échelle simple en fibre de verre.

Escalera de fibra de vidrio simple.



FIBRA DUPLA

ESCADAS
LADDERS
ÉCHELLES
ESCALERAS INDUSTRIALES

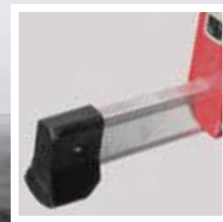
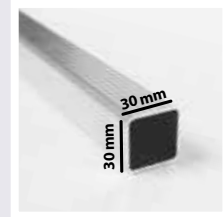
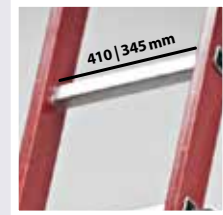

REF.	Barcode	Staircase Icon	Step Ladder Icon	Extension Ladder Icon	Step Ladder Icon	Extension Ladder Icon	Step Ladder Icon	Extension Ladder Icon	Step Ladder Icon	Extension Ladder Icon	Step Ladder Icon	Extension Ladder Icon	Weight Icon
2.00	560 4620 262005	7+7	3,44 m	3,32 m	4,35 m	2,03 m	1,96 m	3,27 m	0,40 m	0,12 m	67 mm	11,90 kg	
2.50	560 4620 262500	9+9	4,56 m	4,40 m	5,43 m	2,59 m	2,50 m	3,81 m	0,40 m	0,12 m	67 mm	14,62 kg	
3.00	560 4620 263002	10+10	5,21 m	5,03 m	5,97 m	2,96 m	2,86 m	4,08 m	0,40 m	0,12 m	67 mm	16,36 kg	
3.50	560 4620 263507	12+12	5,99 m	5,78 m	6,79 m	3,46 m	3,34 m	4,62 m	0,40 m	0,12 m	67 mm	18,82 kg	
4.00	560 4620 264009	14+14	6,81 m	6,57 m	7,60 m	4,00 m	3,86 m	5,16 m	0,40 m	0,12 m	67 mm	21,41 kg	
5.00	560 4620 265006	17+17	8,56 m	8,26 m	9,22 m	4,91 m	4,74 m	5,97 m	0,40 m	0,12 m	67 mm	25,86 kg	
6.00	560 4620 266003	21+21	10,78 m	10,41 m	11,38 m	6,01 m	5,80 m	7,05 m	0,40 m	0,12 m	67 mm	31,05 kg	

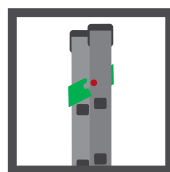
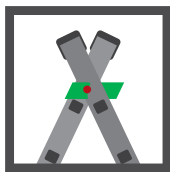

Escada de 2 lances transformável em fibra de vidro.

Fiberglass 2 section transformable ladder.

Échelle transformable 2 plans en fibre de verre.

Escalera transformable de 2 tramos de fibra de vidrio.

Opção
option | option | opción



FIBRA TRIPLA

ESCADAS
LADDERS
ÉCHELLES
ESCALERAS INDUSTRIALES

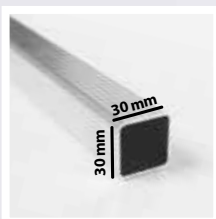

REF.	Barcode	Staircase Icon	Icon 1	Icon 2	Icon 3	Icon 4	Icon 5	Icon 6	Icon 7	Icon 8	Icon 9	Icon 10	Icon 11
2.00	560 4620 262203	7+7+7	4,84 m	4,67 m	5,71 m	3,44 m	3,32 m	4,08 m	0,46 m	0,16 m	67 mm	12,40 kg	
2.50	560 4620 262258	9+9+9	6,24 m	6,03 m	7,06 m	4,56 m	4,40 m	5,16 m	0,46 m	0,16 m	67 mm	15,25 kg	
3.00	560 4620 263309	10+10+10	7,17 m	6,92 m	7,87 m	5,21 m	5,03 m	5,70 m	0,46 m	0,16 m	67 mm	17,19 kg	
3.50	560 4620 263354	12+12+12	8,23 m	7,95 m	8,95 m	5,99 m	5,78 m	6,51 m	0,46 m	0,16 m	67 mm	21,64 kg	
4.00	560 4620 264405	14+14+14	9,61 m	9,28 m	10,31 m	6,81 m	6,57 m	7,33 m	0,46 m	0,16 m	67 mm	24,68 kg	
5.00	560 4620 265501	17+17+17	12,20 m	11,78 m	12,74 m	8,56 m	8,26 m	8,95 m	0,46 m	0,16 m	67 mm	33,21 kg	
6.00	560 4620 266607	21+21+21	15,54 m	15,01 m	15,98 m	10,78 m	10,41 m	11,11 m	0,46 m	0,16 m	67 mm	42,82 kg	

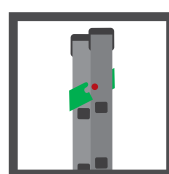
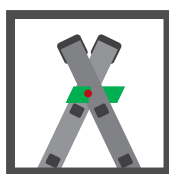

Opção
option | option | opción

Escada de 3 lances transformável em fibra de vidro.

Fiberglass 3 section transformable ladder.

Échelle transformable 3 plans en fibre de verre.

Escala transformable de 3 tramos de fibra de vidrio.



FIBRA CORDA DUPLA

ESCADAS
LADDERS
ÉCHELLES
ESCALERAS INDUSTRIALES

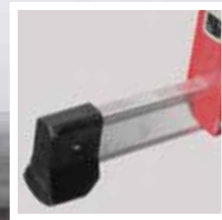
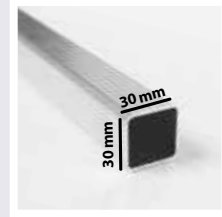
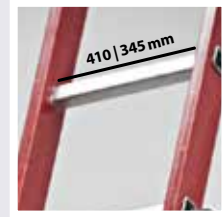

REF.	Barcode	Staircase Icon	Icon 1	Icon 2	Icon 3	Icon 4	Icon 5	Icon 6	Icon 7	Icon 8
2.00	560 4620 260209	7+7	3,44 m	3,32 m	4,35 m	0,40 m	0,12 m	67 mm	12,31 kg	
2.50	560 4620 260254	9+9	4,56 m	4,40 m	5,43 m	0,40 m	0,12 m	67 mm	15,08 kg	
3.00	560 4620 260308	10+10	5,21 m	5,03 m	5,97 m	0,40 m	0,12 m	67 mm	16,78 kg	
3.50	560 4620 260353	12+12	5,99 m	5,78 m	6,79 m	0,40 m	0,12 m	67 mm	19,35 kg	
4.00	560 4620 260407	14+14	6,81 m	6,57 m	7,60 m	0,40 m	0,12 m	67 mm	21,99 kg	
5.00	560 4620 260506	17+17	8,56 m	8,26 m	9,22 m	0,40 m	0,12 m	67 mm	26,47 kg	
6.00	560 4620 260605	21+21	10,78 m	10,41 m	11,38 m	0,40 m	0,12 m	67 mm	31,79 kg	

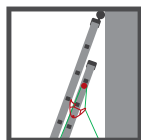
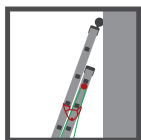

Escada de 2 lances extensível com corda em fibra de vidro.

Fiberglass 2 section extension ladder - rope operated.

Échelle à coulisse à corde 2 plans en fibre de verre.

Escalera extensible 2 tramos con cuerda de fibra de vidrio.

Opção
option | option | opción



FIBRA CORDA TRIPLA

ESCADAS
LADDERS
ÉCHELLES
ESCALERAS INDUSTRIALES

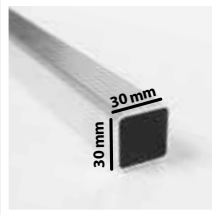

REF.	Barcode	Staircase Icon	Lightning Bolt Icon	Lightning Bolt Icon	Lightning Bolt Icon	Ladder Icon	Ladder Icon	Ladder Icon	Person Icon
2.00	560 4620 000621	7+7+7	4,84 m	4,67 m	5,71 m	0,46 m	0,16 m	67 mm	17,71 kg
2.50	560 4620 062506	9+9+9	6,24 m	6,03 m	7,06 m	0,46 m	0,16 m	67 mm	21,73 kg
3.00	560 4620 000638	10+10+10	7,17 m	6,92 m	7,87 m	0,46 m	0,16 m	67 mm	24,22 kg
3.50	560 4620 063503	12+12+12	8,23 m	7,95 m	8,95 m	0,46 m	0,16 m	67 mm	27,95 kg
4.00	560 4620 000645	14+14+14	9,61 m	9,28 m	10,31 m	0,46 m	0,16 m	67 mm	31,80 kg
5.00	560 4620 000652	17+17+17	12,20 m	11,78 m	12,74 m	0,46 m	0,16 m	67 mm	38,28 kg
6.00	560 4620 000669	21+21+21	15,54 m	15,01 m	15,98 m	0,46 m	0,16 m	67 mm	46,07 kg



Opção
option | option | opción

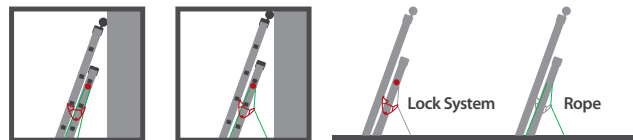

Escada de 3 lances extensível com corda em fibra de vidro.

Fiberglass 3 section extension ladder - rope operated.

Échelle à coulisse à corde 3 plans en fibre de verre.

Escalera extensible 3 tramos con cuerda de fibra de vidrio.



ECO SIMPLES

ESCADAS
LADDERS
ÉCHELLES
ESCALERAS INDUSTRIALES

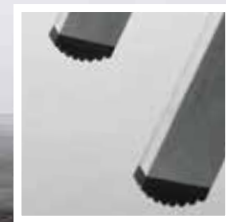

REF.										
2.00	560 4620 220005	6	2,03 m	1,96 m	2,99 m	0,36 m	0,07 m	67 mm	3,12 kg	
2.50	560 4620 225000	8	2,59 m	2,50 m	3,54 m	0,36 m	0,07 m	67 mm	3,96 kg	
3.00	560 4620 230004	9	2,96 m	2,86 m	3,81 m	0,36 m	0,07 m	67 mm	4,48 kg	
3.50	560 4620 235009	11	3,46 m	3,34 m	4,35 m	0,51 m	0,07 m	67 mm	5,53 kg	
4.00	560 4620 240003	12	4,00 m	3,86 m	4,89 m	0,51 m	0,07 m	67 mm	6,27 kg	
5.00	560 4620 250002	16	4,91 m	4,74 m	5,70 m	0,51 m	0,07 m	67 mm	7,78 kg	
6.00	560 4620 260001	19	6,01 m	5,80 m	6,78 m	0,51 m	0,07 m	67 mm	9,40 kg	

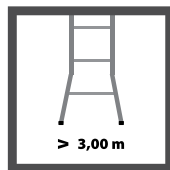
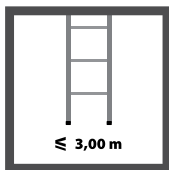

Escada simples em alumínio - degrau redondo.

Aluminium single ladder - round step.

Échelle simple en aluminium - marché rond.

Escala de aluminio simple - peldaño redondo.

Opção
option | option | opción



ECO DUPLA

ESCADAS
LADDERS
ÉCHELLES
ESCALERAS INDUSTRIALES

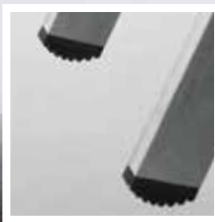

REF.	Barcode	Staircase Icon	Step Icon	Step Height Icon	Step Width Icon	Section Length Icon	Section Width Icon	Section Depth Icon	Section Spacing Icon	Section Thickness Icon	Section Weight Icon	Section Material Icon
2.00	560 4620 202001	6+6	3,44 m	3,32 m	4,35 m	2,03 m	1,96 m	3,27 m	0,55 m	0,12 m	67 mm	7,23 kg
2.50	560 4620 202506	8+8	4,56 m	4,40 m	5,43 m	2,59 m	2,50 m	3,81 m	0,55 m	0,12 m	67 mm	8,97 kg
3.00	560 4620 203008	9+9	5,21 m	5,03 m	5,97 m	2,96 m	2,86 m	4,08 m	0,55 m	0,12 m	67 mm	10,03 kg
3.50	560 4620 203503	11+11	5,99 m	5,78 m	6,79 m	3,46 m	3,34 m	4,62 m	0,55 m	0,12 m	67 mm	12,09 kg
4.00	560 4620 204005	12+12	6,81 m	6,57 m	7,60 m	4,00 m	3,86 m	5,16 m	0,55 m	0,12 m	67 mm	13,59 kg

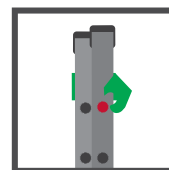
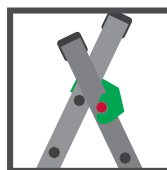

Opção
option | option | opción

Escada de 2 lances transformável em alumínio - degrau redondo.

Aluminium 2 section transformable ladder - round step.

Échelle transformable 2 plans en aluminium - marché rond.

Escala transformable de 2 tramos de aluminio - peldaño redondo.



ECO TRIPLA

ESCADAS
LADDERS
ÉCHELLES
ESCALERAS INDUSTRIALES

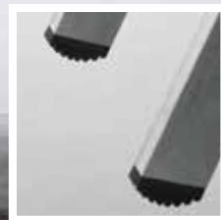
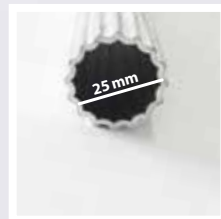

REF.	Barcode	Staircase Icon	Lightning Bolt Icon	Lightning Bolt Icon	Lightning Bolt Icon	Step Icon	Step Icon	Step Icon	Ladder Icon	Ladder Icon	Ladder Icon	Step Icon	Weight Icon
2.00	560 4620 200205	6+6+6	4,84 m	4,67 m	5,71 m	3,44 m	3,32 m	4,08 m	0,61 m	0,16 m	67 mm	11,25 kg	
2.50	560 4620 200250	8+8+8	6,24 m	6,03 m	7,06 m	4,56 m	4,40 m	5,16 m	0,61 m	0,16 m	67 mm	13,86 kg	
3.00	560 4620 200304	9+9+9	7,17 m	6,92 m	7,87 m	5,21 m	5,03 m	5,70 m	0,61 m	0,16 m	67 mm	15,47 kg	
3.50	560 4620 200359	11+11+11	7,95 m	7,68 m	8,68 m	5,99 m	5,78 m	6,51 m	0,61 m	0,16 m	67 mm	18,61 kg	

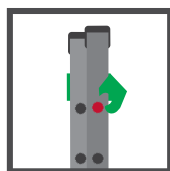
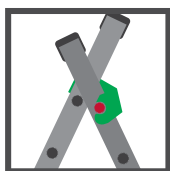

Escada de 3 lances transformável em alumínio - degrau redondo.

Aluminium 3 section transformable ladder - round step.

Échelle transformable 3 plans en aluminium - marché rond.

Escala transformable de 3 tramos de aluminio - peldaño redondo.

Opção
option | option | opción





CLASSIK

ANDAİMES
SCAFFOLDING
ÉCHAFAUDAGE
ANDAİMIOS

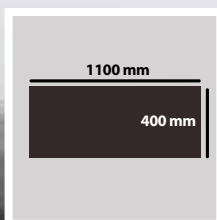

560 4620 111105



5+5



0,88 m



3,00 m



1,58 m



1,70 x 0,53 x 0,16



12,50 kg

Andaime bricolage en aluminium. 3 hauteurs de travail. Montage facilité sans outils.

DIY aluminium scaffold. 3 working heights. Easy to assemble – no tools needed.

Échafaudage en aluminium pour une utilisation bricolage. 3 hauteurs de travail. Montage rapide et sans outil.

Andamio de aluminio para bricolaje. 3 alturas de trabajo. Fácil montaje (sin necesidad de herramientas).



DIY

NF E85-200
NORME FRANÇAISE



MULTIUSOS

ANDAİMES
SCAFFOLDING
ÉCHAFAUDAGE
ANDAİMİOS

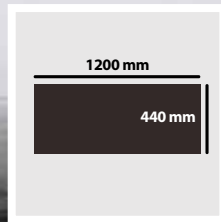

5604620 111112



10+10



1,88 m



4,00 m



2,84 m



1,48 x 0,52 x 0,33



29,13 kg

Andaime bricolage em alumínio. Pode ser utilizado como escada transformável (Pág. 27). Montagem facilitada sem ferramentas.

DIY aluminium scaffold. It can be used as transformable ladder (Pag. 27). Easy to assemble – no tools needed.

Échafaudage en aluminium pour une utilisation bricolage. Peut également s'utiliser comme échelle transformable (Pag. 27). Montage rapide et sans outil.

Andamio de aluminio para bricolaje. Posibilidad de utilizar como escalera transformable (Pag. 27). Fácil montaje (sin necesidad de herramientas).

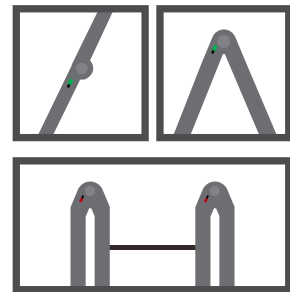

DIY

NF E85-200
NORME FRANÇAISE

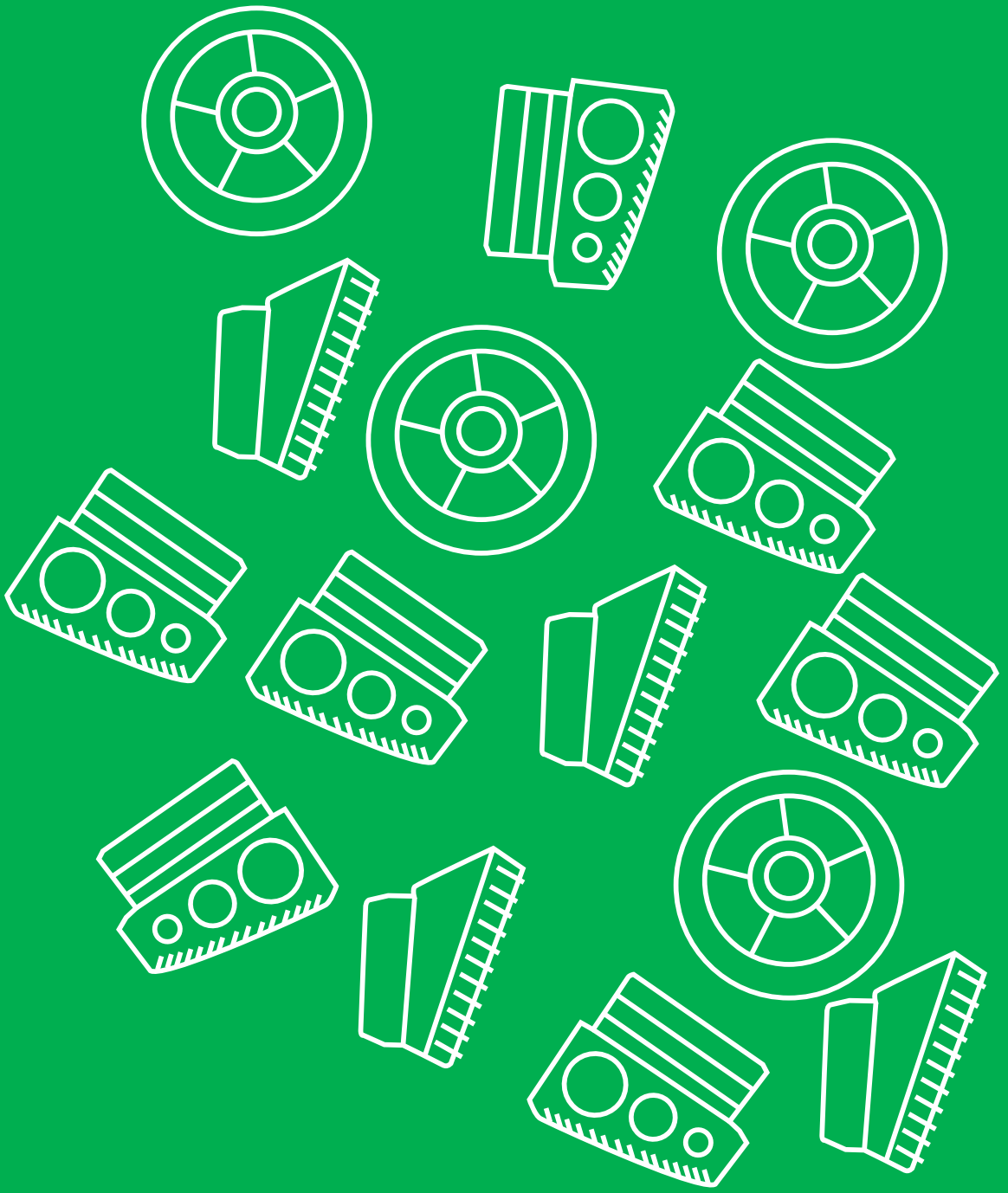





RÉGUAS DE ALUMÍNIO

ALUMINIUM RULLERS
RÈGLES EN ALUMINIUM
REGLES DE ALUMINIO



	REF. 6		REF. 8		REF. 10		REF. 11	
1,00	1000 x 60 x 20mm	0,49 kg	1000 x 80 x 20mm	0,64 kg	1000 x 100 x 20mm	0,77 kg	1000 x 110 x 20mm	1,11 kg
1,50	1500 x 60 x 20mm	0,72 kg	1500 x 80 x 20mm	0,96 kg	1500 x 100 x 20mm	1,14 kg	1500 x 110 x 20mm	1,66 kg
2,00	2000 x 60 x 20mm	0,96 kg	2000 x 80 x 20mm	1,28 kg	2000 x 100 x 20mm	1,52 kg	2000 x 110 x 20mm	2,21 kg
2,50	2500 x 60 x 20mm	1,20 kg	2500 x 80 x 20mm	1,59 kg	2500 x 100 x 20mm	1,89 kg	2500 x 110 x 20mm	2,76 kg
3,00	3000 x 60 x 20mm	1,44 kg	3000 x 80 x 20mm	1,91 kg	3000 x 100 x 20mm	2,27 kg	3000 x 110 x 20mm	3,31 kg
3,50	3500 x 60 x 20mm	1,68 kg	3500 x 80 x 20mm	2,22 kg	3500 x 100 x 20mm	2,64 kg	3500 x 110 x 20mm	3,86 kg
4,00	4000 x 60 x 20mm	1,91 kg	4000 x 80 x 20mm	2,54 kg	4000 x 100 x 20mm	3,02 kg	4000 x 110 x 20mm	4,41 kg
5,00	5000 x 60 x 20mm	2,39 kg	5000 x 80 x 20mm	3,17 kg	5000 x 100 x 20mm	3,77 kg	5000 x 110 x 20mm	5,51 kg
6,00	6000 x 60 x 20mm	2,87 kg	6000 x 80 x 20mm	3,80 kg	6000 x 610 x 20mm	4,52 kg	6000 x 110 x 20mm	6,61 kg



ACESSÓRIOS

ACCESSORIES
ACCESSOIRES
ACCESORIOS



Pé 40 / 50



Pé 33



Terminal 40 / 50



Tapa topo



Pé Elite 50



Pé Elite 40



Terminal 120



Pé Extra 60



Pé Extra 40



Taco Extra frente



Taco Extra degrau



Pé Conforto frente



Pé Conforto traseira



Pé Telescópica
2,60 / 3,80



Pé 58 / 67 / 73 / 80
90 / Fibra



Pé reforçado 58 / 67



Taco travessa 50 / 58 / 67





"U" 58 / 60 / 67 / 73
80 / Fibra



Pé Articulada Telescópica



Tampa topo Articulada
Telescópica



Capa degrau Articulada
Telescópica



Roda



Topo régua 6 / 8 / 10



Topo régua estucador 11



Espeto escada



Gancho escada



Suporte escada



Plataforma Multiusos / Classik



Barra estabilizadora 50 / 58 / 67



Corrimão Extra / Extra Plus



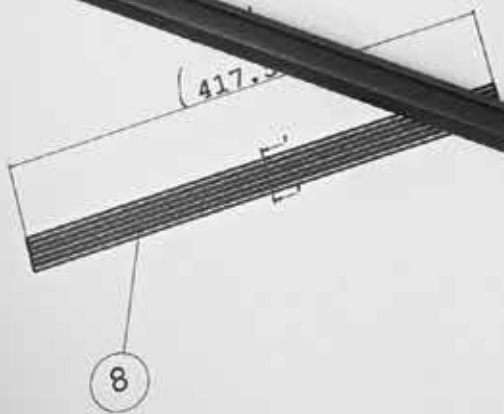
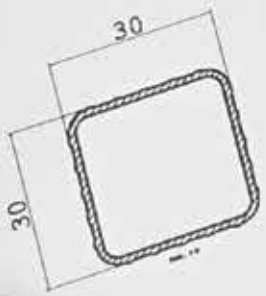
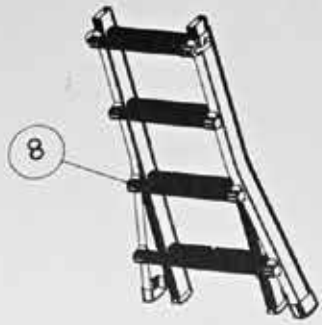
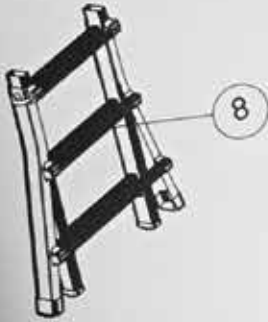

3 Degraus	4 Degraus
1.37	1.02
26.5 - 39	30
1 + 1	
4	
2	
0.846	
43.9	
41	
4	
2	
1	
2	
2	
2	

COA.	DESIGNAÇÃO:	PCS.	MATERIAL
			Degrau
			Artic
	Cliente:		
	N. Obra:		
	Des. nº:		
FERRAL			
RUA DOS SOBRAS, N.º 655			
1825 - 307 CORTEGA - OVR			





	5 Degraus	6 Degraus	7 Degraus	8 Degraus
us	1.86	2.12		2.62
41.5	4D + 44	5D + 46.5	6D + 49	7D + 51.5
1	1 + 1	1 + 1	1 + 1	1 + 1
4	4	4	4	4
5	4	5	7	7
		1.55	1.80	
1.09	1.30	46.2 - 50.9	46.2 - 53.2	
46.2	48.2	41	41	
41	41	4	4	
4	4	2	2	
2	2		1	
	1	1	2	
1	2	2	2	
2	2	0	2	
	2	2	4	
	2	4	28	
	4		1 + 1	
		28	4	
		1 + 1		
		4	1	
		1	36.9	
		36.9	34	
			1	

FERRAL®

 FERRAL®