

Pressure measurement technology

Differential pressure transmitters (stationary/mobile)

Calibration devices and services

Absolute pressure transmitters



A FAMILY-OWNED AND HIGHLY INNOVATIVE SUPPLIER OF CUSTOMISED SOLUTIONS

We offer standardised products, customer-specific solutions, engineering and calibration services. With our own development department (electronics/construction) and a remarkable depth of production expertise, we are able to manufacture a wide range of variants for our customers. A strong quality assurance programme and lean processes have made us a highly professional partner with impressive performance in quality, costs and punctuality. Our quality management system is certified in accordance with **ISO 9001:2015**. We accept our environmental responsibilities in all our processes and corporate decisions – our environmental management system is also certified in accordance with **ISO 14001:2015**.

Long-standing relationships bind us closely to our customers, our approx. 130 employees, the location in Kirchzarten and our suppliers.

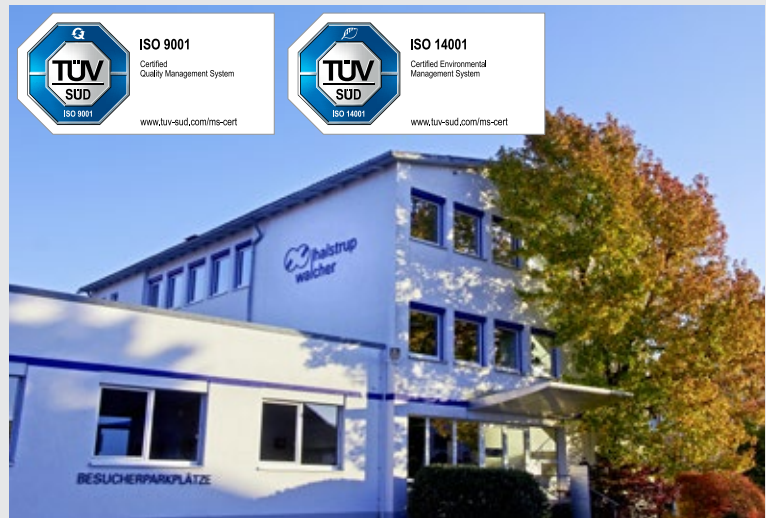

THE HALSTRUP-WALCHER GROUP: SPECIALISTS IN 3 SECTORS

MEASUREMENT TECHNOLOGY



Do you need to control the pressure in your cleanroom to keep contaminated air from entering? Do you need a display panel that shows you relevant physical/chemical parameters at a glance? Do you need to monitor an HVAC air filter or fan? Or maintain overpressure or vacuum in one of your machines?

halstrup-walcher supplies instruments for high precision applications in the area of pressure measurement technology: Pressure transmitters, calibration devices and digital manometers for stationary or mobile use.

halstrup-walcher operates 2 accredited laboratories for DAkkS calibrations for the measurand of pressure and flow rate.

POSITIONING SYSTEMS



As a manufacturer of machine tools, your customers expect you to supply highly flexible solutions with minimal retooling times. Format changes should be performed automatically, with highest precision and as quickly as possible. And, naturally, you want to be able to offer your customer optimum availability of the machine – supported by condition monitoring for the components.

Positioning systems from include EC motor, gear, absolute encoder, the motor control system with a choice of 10 different bus communication systems and on-board communication to PLC, along with a wide variety of designs and performance characteristics.

TAILOR-MADE DRIVE SOLUTIONS



You need to make parts move, linear or rotary. Optimised for the existing construction space and with a sharp eye on the costs. With a constantly high level of precision. You need this solution quickly and tailored to your specific requirements. With or without housing. As a motor/gearbox combination. Regulated or with a control system or as a purely mechanical solution. With analog or digital communication.

halstrup-walcher offers solutions covering every aspect of spur gearboxes and actuators. We develop mechanical designs, electronics and all the relevant stages of the manufacturing process in-house.

LEAN MANAGEMENT AT HALSTRUP-WALCHER

Focus on the customer and optimised internal processes

A number of years ago, business theorists spoke of a "magic triangle" of quality (Q), costs (C) and punctuality (P). These three factors were considered magical because any measures for improvement could benefit no more than two of them at any time – and these gains could only be obtained at the expense of the third. With the help of lean management, halstrup-walcher has succeeded in breaking the spell of this *magic triangle*. Faults, disruptions and waste are eliminated systematically from all relevant processes. This liberates the whole team to concentrate fully on the real needs of our customers.

Shop floor management has also brought previously unimaginable successes. Employee consultations take place in each department every working day. These are forums for discussion of current issues. Measures for eliminating these issues immediately and permanently are discussed and agreed at follow-up meetings in the company. These take into account all the relevant information. Everyone contributes, no problem is ignored. Solutions to the problems are implemented without delay. It is a culture that has won the hearts and minds of both our staff and our customers. halstrup-walcher has now begun *exporting* its insights into lean management and offers these as a service to medium-sized enterprises.

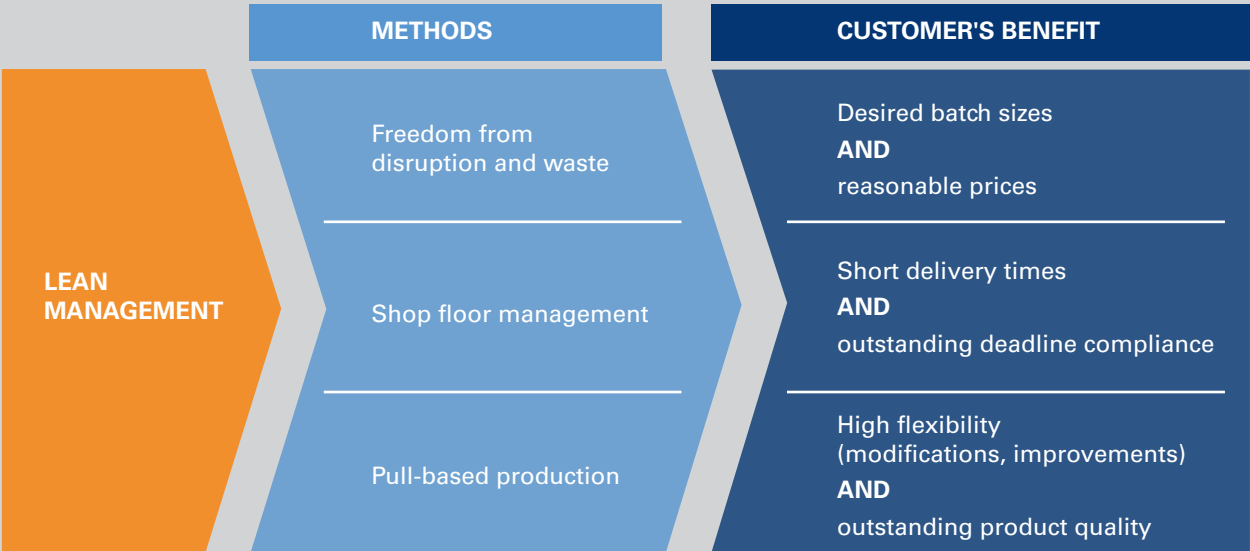

CONTENTS

HALSTRUP-WALCHER PRESSURE SENSOR TECHNOLOGY AND OEM SOLUTIONS	P. 6	
DIFFERENTIAL PRESSURE TRANSMITTERS	P. 11	
DISPLAY PANELS FOR PROCESS MONITORING	P. 23	
PORTABLE DIGITAL PRESSURE GAUGES	P. 27	
ABSOLUTE PRESSURE TRANSMITTERS	P. 31	
MOBILE CALIBRATION DEVICES	P. 34	
VOLUME FLOW MEASUREMENT	P. 39	
CALIBRATION SERVICES	P. 42	

FIND SUITABLE MEASUREMENT AND DISPLAY DEVICES

Simply click your way to the most suitable measurement and display device. Our configurator will suggest a selection of products. After completing the configuration you can:

- view technical details
- compare products or
- directly request a quotation or consultation.

www.halstrup-walcher.de/configurator

► Navigation point: "Products"

► Product configurator

► Pressure measurement technology and panels



halstrup-walcher

PRESSURE SENSORS AND OEM SOLUTIONS

HALSTRUP-WALCHER PRESSURE SENSOR TECHNOLOGY

Pressure measurement devices made by halstrup-walcher GmbH have been designed for use with non-aggressive, gaseous media. They operate using the principle of inductive measurement. At the heart of the technology lies a membrane made from beryllium bronze. Inductive displacement transmitters measure the deflection of this membrane without touching it. The membrane is positioned between two measurement chambers and can thus record both positive and negative differential pressures. The measuring cell is not subject to wear due to friction or mechanical influences.

Beryllium bronze is a highly elastic material. It has outstanding long-term stability, behaves well under a variety of temperature conditions and offers very low hysteresis. As a result, our high-quality pressure gauges are suitable for taking measurements at pressures as low as a few Pascal.

OUR MEASUREMENT SYSTEMS

The patented **dual throttle system** was developed and is manufactured by halstrup-walcher. It sends a differential signal which is linearised by the electronics. It is used in high quality differential pressure transmitters and digital pressure gauges.

The **differential transformer** (LVDT) offers excellent linearity and is primarily used in pressure calibration devices.

For basic applications, a **piezoresistive precision measuring cell** is also used.

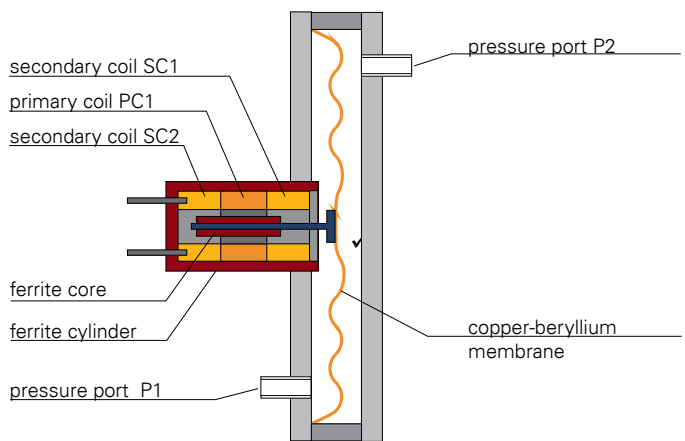
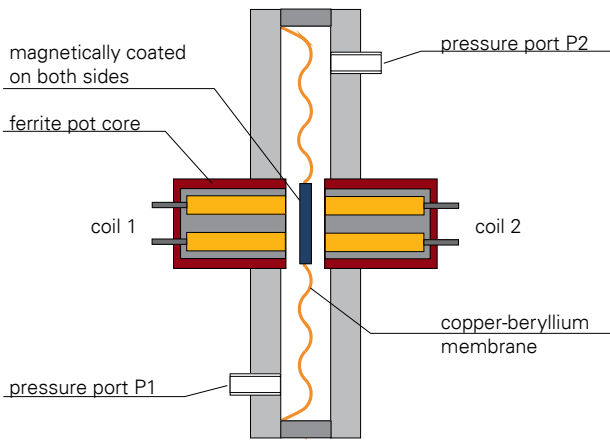

ADVANTAGES OF HALSTRUP-WALCHER PRESSURE MEASUREMENT SYSTEMS

- ✓ Ideal even for small measurement ranges
- ✓ Exceptional long-term stability guarantees reliable operation over many years
- ✓ Absolute zero-point stability (see p. 7)
- ✓ High overload resistance (see p. 7)
- ✓ Perfect for positive and negative differential pressures
- ✓ For symmetrical or asymmetrical measurement ranges
- ✓ Separation of the two connected sides ensures no overflow

TAILOR-MADE MEASUREMENT RANGES

Many of our instruments can be scaled in accordance with specific customer requirements. This enables them to be integrated into the process with maximum efficiency.

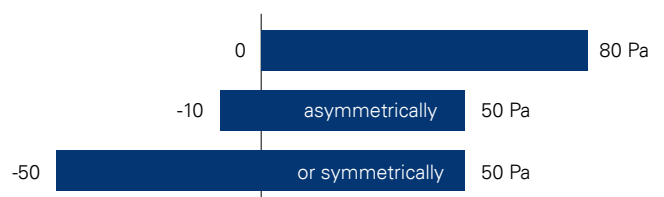

Three examples of a scale in the 100 Pa measurement range

MEASUREMENT WITHOUT ZERO POINT DRIFT

A stable measurement signal is critical in any application but especially so when working with small differential pressures. Any drift renders the measurements unreliable. If an instrument is being used to maintain *overpressure in a cleanroom* inaccurate measurements could result in microbe or dust levels, for example, rising above the permitted limits.

In halstrup-walcher instruments, solenoid valves ensure regular zero-point correction. In combination with exceptionally stable sensors, they are very effective in preventing drift over the long-term. During this patented procedure, the previous measurement is held to prevent interruption of the signal. Consequently, measurements remain stable and reliable even after many years of service.

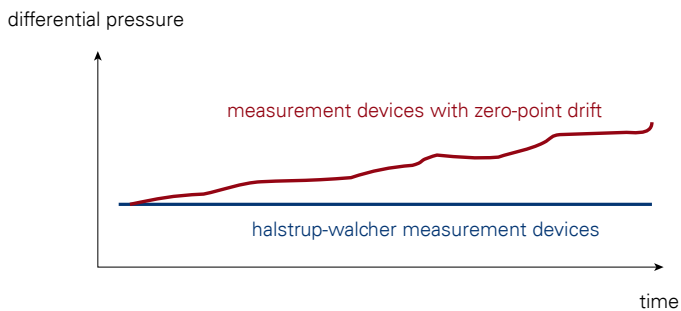

Advantages of zero-point correction

- ✓ Excellent reliability of the differential pressure value
- ✓ No costly and time-consuming adjustments required
- ✓ Process safety guaranteed at all times

AUTOMATIC ZERO-POINT ADJUSTMENT

Solenoid valves regularly open the two chambers of the measurement cell to the interior of the device. The microprocessor then sets the differential pressure value currently measured to zero.

The patented zero-point calibration procedure is initiated immediately after measurement begins. The process takes only about 4 seconds. During this time, the previous signal is held. The procedure is repeated at regular intervals – hourly in most devices.

If your application requires targeted zero-point calibration, some devices allow you to create your own definition or deactivate or control it via a digital interface.

Normal operation

(measurement of differential pressure in the process)

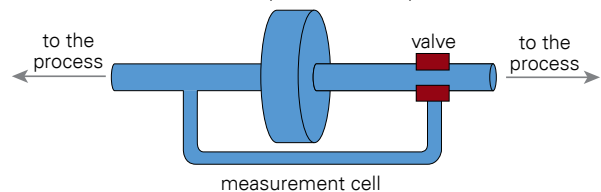

Automatic adjustment

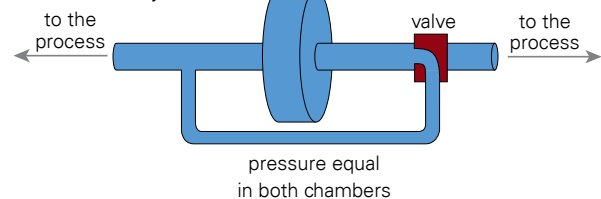

HIGH OVERLOAD RESISTANCE

Our pressure measurement technology is highly accurate. However, it must also be protected against damage. Here, too, halstrup-walcher sensors provide the optimum solution: If the measurement cell detects excessive pressure (pressure peak or overload), the solenoid valves close within milliseconds. This prevents the membrane against deformation. After a few moments, a new measurement is taken to determine whether normal measurement operations can resume. The system then performs an automatic zero-point calibration. The result is a durable technology that not only offers excellent reliability but also outstanding protection of your investment.

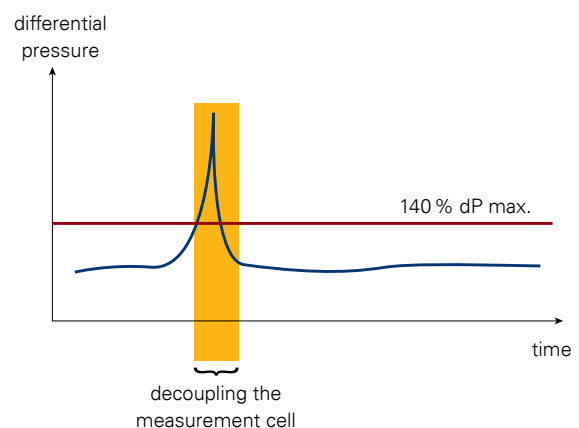

CONVERSION TABLE

	Pa	hPa / mbar	kPa	bar	psi	mmH ₂ O	inH ₂ O	mmHg	inHg
Pa	1	0.010	0.001	0.00001	0.0001	0.102	0.004	0.008	0.0003
hPa / mbar	100	1	0.1	0.001	0.015	10.197	0.401	0.750	0.030
kPa	1 000	10	1	0.010	0.145	101.968	4.014	7.502	0.295
bar	100 000	1 000	100	1	14.514	10 196.798	401.445	750.188	29.499
psi	6 891.799	68.966	6.894	0.069	1	703.235	27.701	51.813	2.036
mmH ₂ O	9.804	0.098	0.010	0.000098	0.001	1	0.039	0.073	0.003
inH ₂ O	249.004	2.490	0.249	0.00249	0.036	25.381	1	1.865	0.073
mmHg	133.316	1.333	0.133	0.00133	0.019	13.624	0.536	1	0.039
inHg	3 386.387	33.898	3.386	0.03386	0.491	345.901	13.624	25.381	1

Please read the lines from left to right. Example: 1 bar = 100 kPa

UNDERSTANDING OUR ACCURACY SPECIFICATIONS

The degree of **measurement uncertainty** is a statistical value, which takes into account the "error contributions" of the measurement device itself as well as other influencing factors. These specifications also include the margin of error for the reference during adjustment in the manufacturing process. Unless otherwise indicated, the margin of error is always stated with reference to the standard measurement uncertainty expanded by the factor $k=2$ (coverage probability 95%).

Example: The P26 differential pressure transmitter offers a degree of measurement uncertainty of "±0.2 % of max. value." "of max. value" means "of the upper range value". For a scaled measurement range of 0..80 Pa, e.g. the max. value of 80 Pa must be considered. The consequence of the degree of measurement uncertainty in the reference is +0,3 Pa. In this example, the degree of measurement uncertainty is calculated as follows:

a) ±0.2 % of max. value = ±0.2 % x 80 Pa = ±0.16 Pa

b) plus +0.3 Pa margin of error for the reference

→ In this case, the total degree of measurement uncertainty is ± 0,46 Pa

→ If you measure a value of 60 Pa, you can therefore assume with a 95 % probability that the actual value lies somewhere between 59.54 Pa and 60.46 Pa, see graph below (see diagram).

Practical tip: The upper range value of the sensor you use should be approx. 10.. 30 % higher than the highest pressure value you expect to occur. This enables you to measure and record unexpected pressure peaks too.

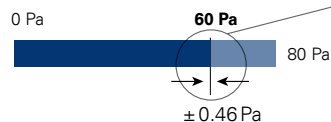

In addition, the term **temperature coefficient span** is used to describe the deviations that can occur if the pressure transmitter performs its measurements not at 20°C but, e.g. at 35°C (i.e. 15 K higher). According to the data sheet, a value of e.g. ± 0.03 % of max. value/K should be used for the P26. At 60 Pa and an ambient temperature of 35°C there is an additional "temperature error in the measurement range" of ± 0.03 % of max. value/K x 60 Pa x 15 K = ± 0.27 Pa.

Temperature coefficient span

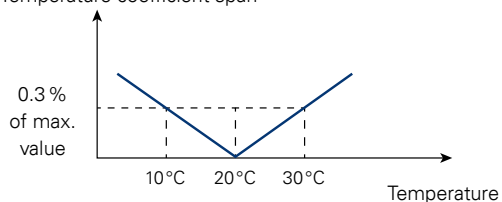

Practical tip: If possible, install the pressure transmitter in a protected position with room temperature. The connecting tubing from the measurement point to the pressure transmitter can be several metres in length as long as it is not exposed to sources of heat.

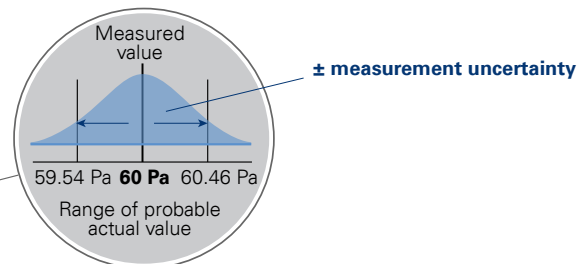

DEVELOPMENT OF CUSTOMER-SPECIFIC VARIANTS

In this catalogue you will find a wide range of attractive series products. The development of customer-specific variants of the highest quality and supplying them over many years is one of our greatest strengths.

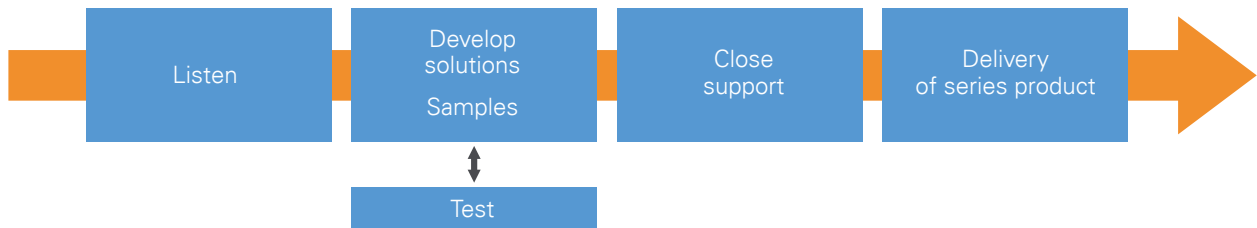

DESIGNED TO YOUR SPECIFICATIONS

We can adapt all the relevant parameters to your requirements:

- housing size and form
- measurement units (differential pressure, absolute pressure, volume flow, temperature)
- accuracy specifications
- output signals (analog, digital, bus)
- supply voltage
- type of display, LEDs and other signals
- mechanical modules for integration into your process (mountings, primary elements, etc.)

Special feature: We have optimised our processes to enable us to offer you deliveries of small quantities each year at attractive prices. Naturally, we guarantee traceable quality and punctual delivery for all our products.

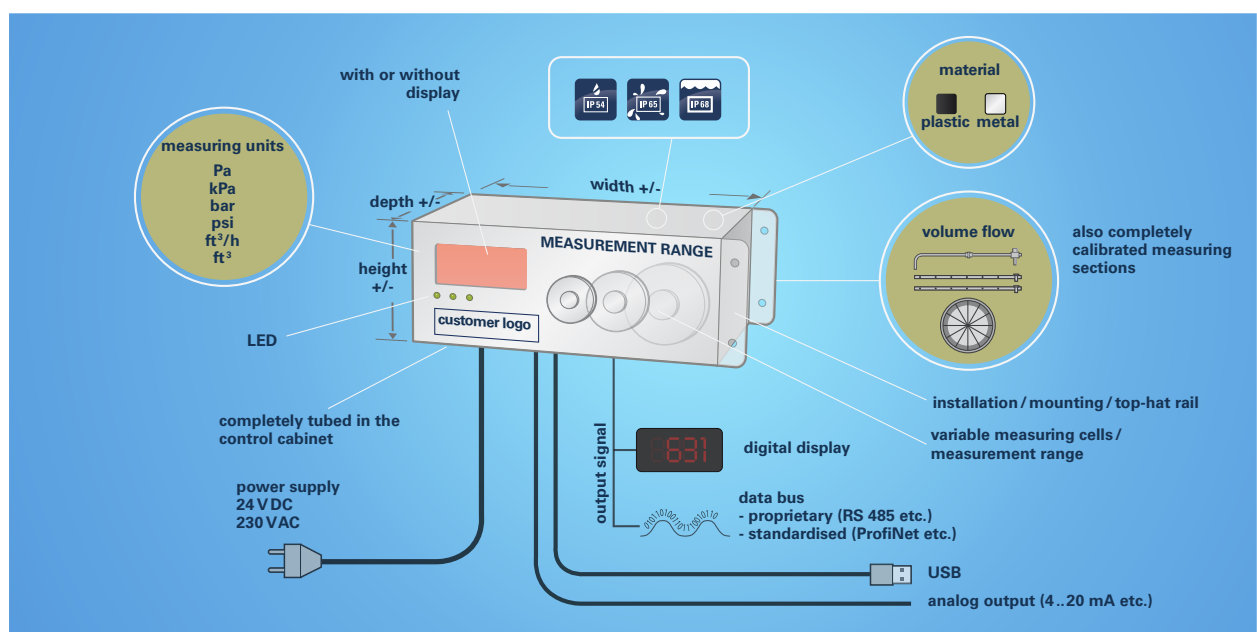
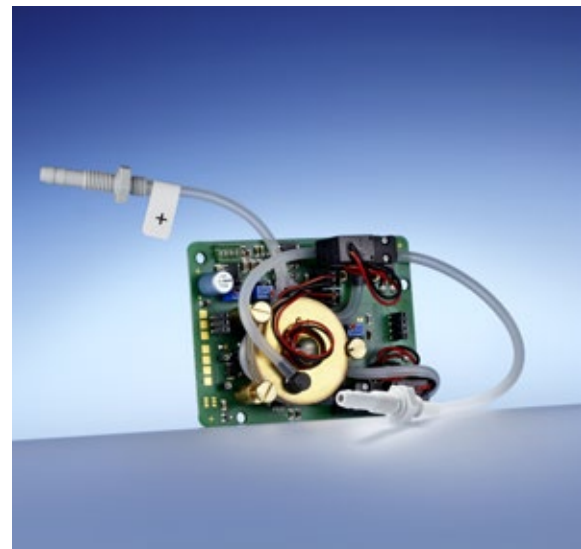









DIFFERENTIAL PRESSURE TRANSMITTERS

MEASUREMENT OF DIFFERENTIAL PRESSURE

Measurement of differential pressure is useful in a broad range of applications. It is used in ventilation and air-conditioning technology but also in many areas of air handling process technology. The next pages show a number of these. You can find more information about our pressure sensor technology on p.6.

halstrup-walcher offers a wide range of products for stationary measurement of differential pressure:

Product	PUC24	PUC28(K)	P26	P34	P29	PU/PI/PIZ	PS27	REG21
Details on	p. 14	p. 15	p. 16	p. 17	p. 18	p. 19	p. 20	p. 21
								
Application	Process monitoring for clean-rooms (Pa, °C, % rH), with stainless steel front	Process monitoring panel aluminium, anodised (optional: with calibration port) (Pa, °C, % rH)	High precision, freely scalable pressure transmitter for critical applications	Measuring transmitter with very small dimensions – ideal for the control cabinet	High precision, freely scalable pressure transmitter for natural gas	For standard applications. PIZ: in two wire technology	A basic sensor for simple applications	Measurement and regulation of pressure
Housing installation	Installed in wall (panel)	Mounted on a wall/top-hat rail						Rack
Max. measurement range	± 250 Pa		± 100 kPa					
Min. measurement range	± 100 Pa		± 10 Pa		± 250 Pa		± 50 Pa	
Degree of measurement uncertainty (0.3 Pa margin of error for the reference)	± 0.5 % ¹⁾ (standard)		± 0.2 % ¹⁾ (optional) ± 0.5 % ¹⁾ (standard)		± 0.2 % ¹⁾ (optional) ± 0.5 % ¹⁾ (standard)		± 0.2 % ¹⁾²⁾ ± 0.5 % ¹⁾ ± 1 % ¹⁾ ± 2 % (≥ 100 Pa) or ± 3 % (for 50 Pa) of the set value	
Square-root (volume flow)	-	-	✓	✓ ³⁾	✓	-	-	-
Display	✓	✓	optional	-	optional	optional	optional	✓

¹⁾ of max. value ²⁾ for measurement ranges ≥ 250 Pa

³⁾ optionally with stat. pressure sensor and temperature analogue output for compensation

ACCESSORIES

Certificates (see p.42)

DAkkS calibration certificate (German)
DAkkS calibration certificate (English)
ISO factory calibration certificate

Order no.

9601.0003
9601.0004
9601.0002

User software

You can set the parameters for our instruments or monitor and record measurements using a PC via a USB or RS232 interface. These features are supported by our free user software. This also allows you to transfer your settings to other devices by saving and reusing them.

Connecting components

Silicone tubing ID 5 mm, OD 9 mm, red (please state length required) 9601.0160
Silicone tubing ID 5 mm, OD 9 mm, blue (please state length required) 9601.0161
Norpren tubing (please state length required) 9061.0132
Y-piece for tubing 9601.0171

Our user software is compatible with the following pressure transmitters: PUC24, PUC28(K), P26, P34 and P29.

You can download the file here:

www.halstrup-walcher.de/en/software

Pressure ports

We can supply a wide range of customer-specific pressure ports, e.g. various cutting ring couplings or hose connectors.

MEASUREMENT OF DIFFERENTIAL PRESSURE AND REGULATION OF PRESSURE

... IN CLEANROOMS

In cleanrooms, it is vital to prevent contaminated air flowing in from corridors or areas with lower cleanroom classifications. This can be achieved by **maintaining a continuous overpressure**. The heart of this system is a high-precision differential pressure transmitter operating in the low Pascal range

- for installation in a wall (panel), (e.g. PUC, see p. 14 and p. 15)
- for mounting on a wall (e.g. P26, see p. 16)
- for installation in a control cabinet (e.g. P34, see p. 17)

The standard ISO 14644 requires continuous monitoring and regulation of pressure for all cleanrooms. Spot checks must be performed on the measurements instruments at regular intervals.

- use of the KAL portable, high precision calibration and measurement device (see p. 36 and p. 37)

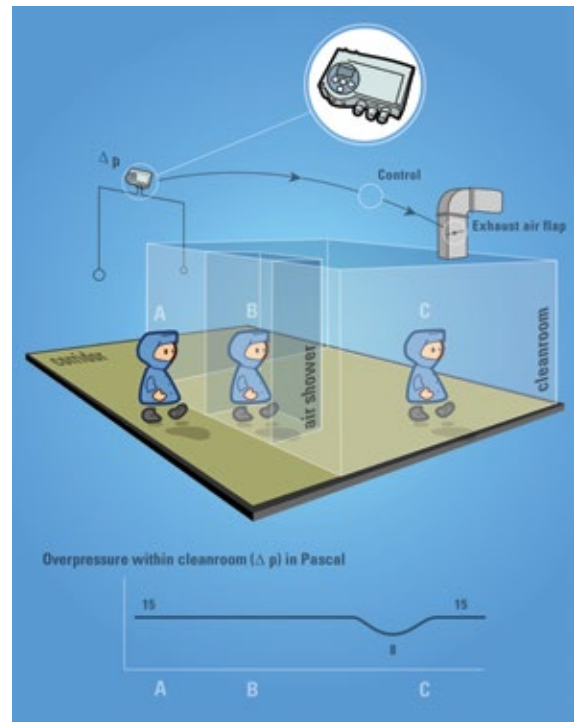

$$P_1 > P_2 > P_3$$

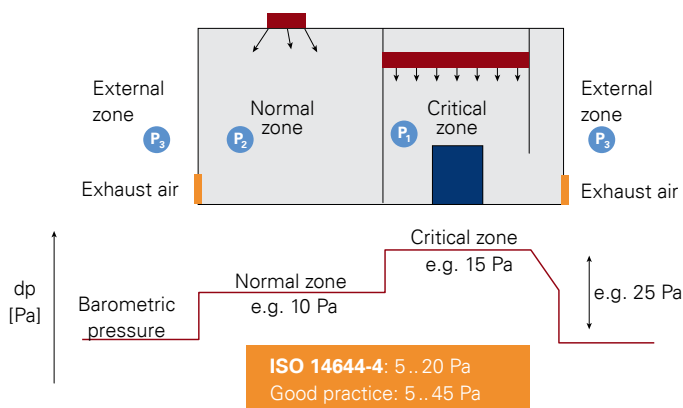

... IN HOSPITALS

Excluding air that contains bacteria can be a matter of life and death in hospitals, e.g. operating theatres. Here, too, this can be achieved by ensuring a constant **overpressure** so no contaminated air is able to enter the room from surrounding areas.

The opposite principle can also be used, e.g. in isolation wards. Quarantine is key to preventing the spread of epidemics. In this case, the room must be kept at a constant **underpressure** relative to its surroundings in order to prevent bacteria/viruses escaping.

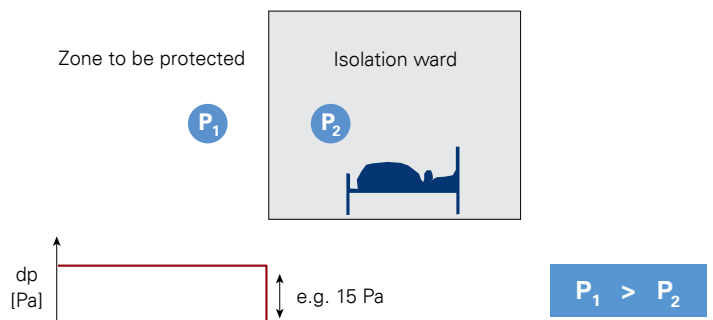

MEASUREMENT OF DIFFERENTIAL PRESSURE AND REGULATION OF PRESSURE

... IN FILLING MACHINES AND HYGIENIC PLANTS

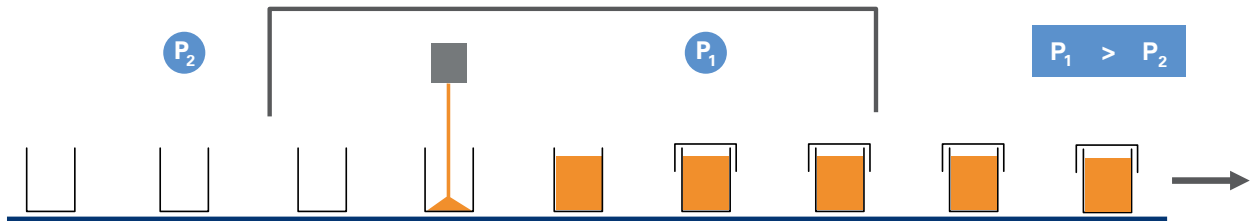

Hygiene and bacteria-free environments are key requirements in both the pharmaceutical and food processing industries. They can be achieved by using appropriate materials and sophisticated cleaning processes. Product quality may be compromised if the end product comes into contact with the surrounding air, e.g. during filling or packaging. If this air has not been processed correctly, it will transport microbes and other contaminants (oil aerosols, particles etc.) directly to the product.

Some larger hygienic production plants are operated completely inside cleanrooms. However, this approach is not efficient if only a small, enclosable hygienic area is required. *Mini-environments* – isolated, hygienic areas – offer a practical solution to this problem. They effectively repel microbes and contaminants.

Accurate measurement and regulation of differential pressure is the key to maintaining a constant and safe **overpressure** within the mini-environment. Excellent long-term stability is critical in order to prevent unplanned decreases in pressure over time. halstrup-walcher supplies differential pressure transmitters for mini-environments:

- for control cabinets P34 (see p. 17)
- for mounting on walls P26 (see p. 16)
- for mounting in walls (panel version): PUC24 or PUC28K (see p. 14/p. 15)



The pressure in the filling room must be **higher** than that of the surrounding areas or particles/oil etc. may enter the zone in which the product is being handled.

Measurement ranges	± 100 Pa or ± 250 Pa freely scalable within this range
Margin of error (0.3 Pa margin of error for the reference)	± 0.5 % of max. value
Temperature coefficient span	0.03 % of max. value/K (10..50 °C)
Temperature coefficient zero point	± 0 % (cyclical zero-point correction)
Overload capacity	200 x
Medium	air, all non-aggressive gases
Max. system pressure	10 kPa
Sensor response time	25 ms
Time constants	25 ms..40 s (adjustable)
Input signal humidity/temperature module (galvanically separated)	0..10 V, R _i = 470 kΩ 0/4..20 mA, R _i = 50 Ω adjustable
Operating temperature	10..50 °C
Storage temperature	-10..70 °C
Power consumption	approx. 7 VA
Weight	approx. 1 kg
Pressure ports	for tubing NW 3..6 mm
Protection class	IP65 (recessed in the wall)
Certificates	CE

Supply voltage

24 VDC, ± 10 % smoothed

Output

0..10 V (R_i > 2 kΩ)
0/4..20 mA (R_i < 500 Ω) adjustable

2 contact points, 6 A, 230 VAC,
may be configured as desired within this pressure range

Measurement range

A

± 100 Pa	0
± 250 Pa	1

Data interface

B

none	0
PROFIBUS DP (optional) ¹⁾	DP
RS 232 (optional)	2

¹⁾ GSD-Download at www.halstrup-walcher.de/en/software

Bus connection

C

none	0
9-pin Sub-D flush type connector ²⁾	D
sub-D plug with 150 mm cable	DK
round pin connector M 12 with 150 mm cable	RK

²⁾ not suitable for wall thicknesses greater than 5 mm

Order code	A	B	C
PUC 24	-	-	-

Can be pre-set on request:
Time constant, relay parameter, analogue output,
deactivation of the cyclic zeroing (only for PROFIBUS DP)



Features

- Cleanroom panel (stainless steel) for displaying air-conditioning data
- Integrated, high precision measurement of differential pressure
- %rH/°C transmitters switchable (independent of manufacturer)
- Optimum cleanroom design (TU Munich/Weihenstephan)
- Solvent resistant stainless steel surface
- 3 analog outputs, optional digital interface
- Acoustic alarm when the threshold value is exceeded, acknowledgement via key
- Optical alarm signal if critical values are exceeded (cyclically inversed/normal)
- Bilingual menu (English/German) (others on request)
- 2 contact points (6 A/230 VAC)
- 2 adjustable limit switches permit the connection of signalling devices and save additional wiring

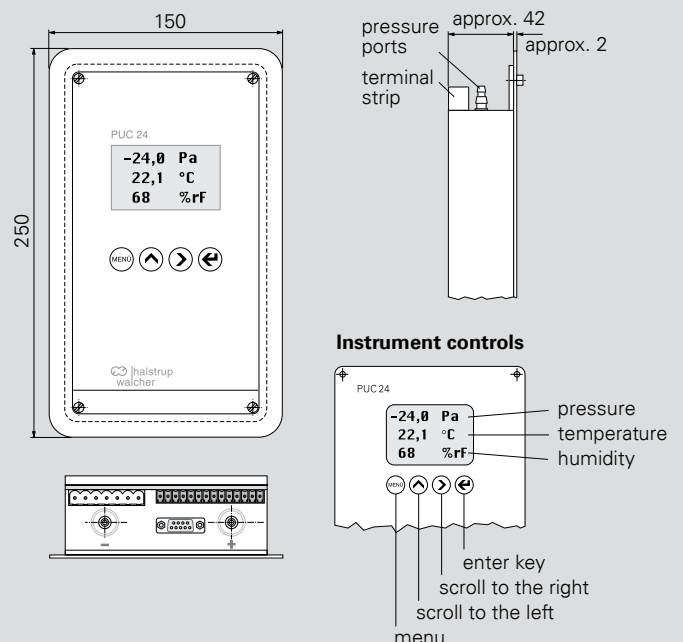



Features

- Process panel (Aluminium, anodised) for displaying air-conditioning data
- Integrated, high precision measurement of differential pressure
- % rH/°C transmitters switchable (independent of manufacturer)
- Anodised, aluminium housing with easy-to-clean front surface
- With external calibration ports (*design "K"*), for on-site calibration without disassembly
- 3 analog outputs, optional digital interface
- Acoustic alarm when the threshold value is exceeded, acknowledgement via key
- Optical alarm signal if critical values are exceeded (cyclically inversed/normal)
- Bilingual menu (English/German) (others on request)
- 2 contact points (6 A/230 VAC)
- 2 adjustable limit switches permit the connection of signalling devices and save additional wiring

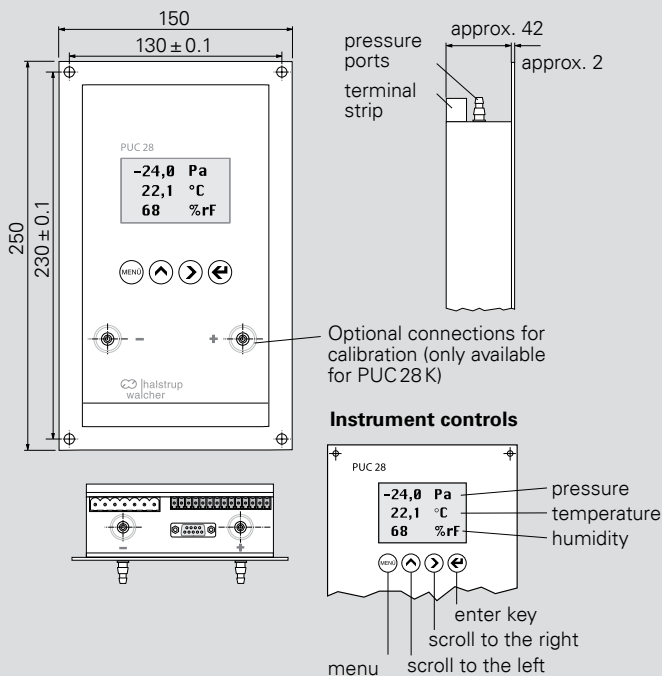

Measurement ranges	± 100 Pa or ± 250 Pa freely scalable within this range
Margin of error (0.3 Pa margin of error for the reference)	± 0.5 % of max. value
Temperature coefficient span	0.03 % of max. value/K (10.. 50 °C)
Temperature coefficient zero point	± 0 % (cyclical zero-point correction)
Overload capacity	200 x
Medium	air, all non-aggressive gases
Max. system pressure	10 kPa
Sensor response time	25 ms
Time constants	25 ms.. 40 s (adjustable)
Input signal humidity/temperature module (galvanically separated)	0..10 V, R _i = 470 kΩ 0/4..20 mA, R _i = 50 Ω adjustable
Operating temperature	10.. 50 °C
Storage temperature	-10.. 70 °C
Power consumption	approx. 7 VA
Weight	approx. 1 kg
Pressure ports	for tubing NW 3..6 mm
Protection class	IP65 (recessed in the wall)
Certificates	CE

Supply voltage

24 VDC, ± 10 % smoothed

Output

0.. 10 V (R_i > 2 kΩ)

0/4..20 mA (R_i < 500 Ω) adjustable

2 contact points, 6 A, 230 VAC,
may be configured as desired within this pressure range

Model	Measurement range	A
PUC 28	± 100 Pa	0
PUC 28	± 250 Pa	1
PUC 28 K ¹⁾	± 100 Pa	K2
PUC 28 K ¹⁾	± 250 Pa	K3

¹⁾ "K": with externally accessible pressure calibration ports (no disassembly) (see photo)

Data interface	B
none	0
PROFIBUS DP (optional) ²⁾	DP
RS 232 (optional)	2

²⁾ GSD-Download at www.halstrup-walcher.de/en/software

Bus connection	C
none	0
9-pin Sub-D flush type connector ³⁾	D
sub-D plug with 150 mm cable	DK
round pin connector M 12 with 150 mm cable	RK

³⁾ not suitable for wall thicknesses greater than 5 mm

Order code	A	B	C
PUC28			

Can be pre-set on request:

Time constant, relay parameter, analogue output, deactivation of the cyclic zeroing (only for PROFIBUS DP)

Measurement ranges (also ± measurement ranges) others available upon request	10/50/100/250/500 Pa 1/2.5/5/10/20/50/100 kPa freely scalable from 10..100 % within a measurement range
Margin of error (0.3 Pa margin of error for the reference)	± 0.2 % or ± 0.5 % of max. value
Temperature coefficient span	0.03 % of max. value/K (10..50 °C)
Temperature coefficient zero point	± 0 % (cyclical zero-point correction)
Max. system pressure/ Overload capacity	600 kPa for measurement ranges ≥ 2.5 kPa 200 x for measurement ranges < 2.5 kPa
Medium	air, all non-aggressive gases
Sensor response time	25 ms
Time constants	25 ms..40 s (adjustable)
Operating temperature	10..50 °C
Storage temperature	-10..70 °C
Power consumption	approx. 6 VA
Weight	approx. 750 g
Cable glands	3 x M 16
Pressure ports	for tubing NW 6 mm, others available on request
Protection class	IP 65, with USB: IP 40
Certificates	CE, CSA

Output (linear/ root-extracted) ¹⁾	A
0..10 V (R _L ≥ 2 kΩ)	1
0..20 mA (R _L ≤ 500 Ω)	0
4..20 mA (R _L ≤ 500 Ω)	4
± 5 V (R _L ≥ 2 kΩ)	5

¹⁾ output signals can be configured freely

Power supply	B
24 VAC/DC ± 10 %	24ACDC
24 VAC + 6 % (with galvanic separation)	24AC
230/115 VAC - 15 %	230/115

Measurement range	C
Measurement range e.g. 0..10 Pa, -10..50 mbar, ± 100 mmHg (etc.)	

Margin of error	D
± 0.2 % of max. value	2
± 0.5 % of max. value	S

Display + keyboard	E
none	0
multi-coloured LCD and keyboard	LC

Contact points	F
none	0
air meter	1
2 relays (changeover contacts) max. 230 VAC, 6 A	2

Data interface	G
none	0
USB (data cable supplied)	U0
External zero-point calibration	0X
External zero-point calibration and USB (data cable supplied)	UX

Order code	A	B	C	D	E	F	G
P 26	-	-	-	-	-	-	-

Can be pre-set on request:
Time constant, relay parameter, analogue output root-extracted / linear, deactivation of the cyclical zeroing



Features

- High precision differential pressure transmitter for air-conditioning, cleanroom and process
- Top-hat rail or wall mounting
- Wide range of units for pressure and volume flow
- Also ± measurement ranges
- Scalable measurement ranges and units
- Zero-point correction prevents zero-point drift
- Built-in valve provides a high level of overpressure protection
- Multilingual menu (English/French/German/Italian)

Optional

- Contact points with adjustable switching outputs
- Set the zero-point via an external interface
- USB interface (free parameterisation software at www.halstrup-walcher.de/en/software)
- Air meter function (see p. 39)

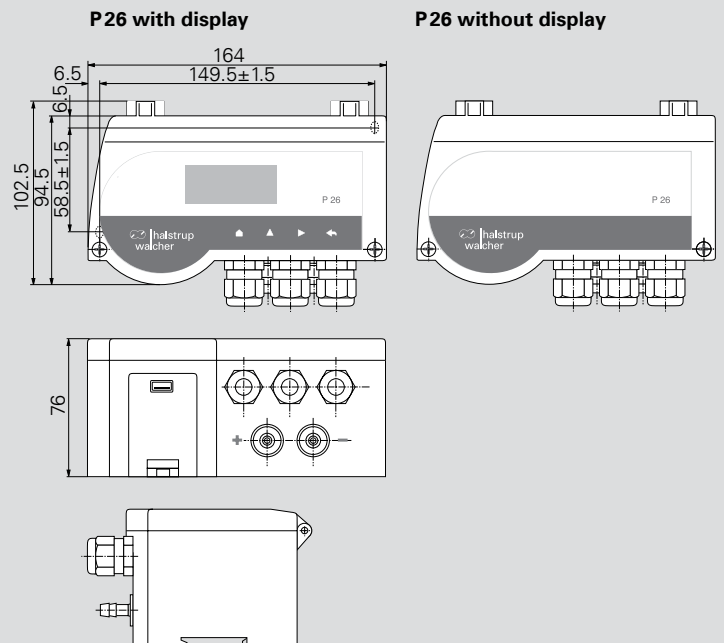



Measured data differential pressure

Measurement ranges (also ± measurement ranges) others available upon request	10/50/100/250/500 Pa 1/2.5/5/10/20/50/100 kPa freely scalable from 10..100 % within a measurement range
Margin of error (0.3 Pa margin of error for the reference)	±0.2 % or ±0.5 % of max. value
Temperature coefficient span	0.03 % of max. value/K (10..50 °C)
Temperature coefficient zero point	±0 % (cyclical zero-point correction)
Max. system pressure/ Overload capacity	400 kPa measurement ranges ≥ 2.5 kPa 200 x measurement ranges < 2.5 kPa
Medium	air, all non-aggressive gases
Sensor response time	25 ms
Time constants	25 ms..60 s (adjustable)
Operating temperature	10..50 °C
Storage temperature	-10..70 °C
Power consumption	approx. 6 VA
Weight	approx. 450 g
Connections	Screw terminals (connection capacity 0.25..2.5 mm ²)
USB interface	USB 2.0 Full-Speed Slave (Mini USB)
Pressure ports	for tubing NW 4 or 6 mm
Protection class	IP20
Certificates	CE

Measured data for P-/T-compensated volume flow (optional)

Measured range absolute pressure	200 kPa
Accuracy absolute pressure	±2.0 % of max. value
Temperature input	4..20 mA, R _i = 130 Ω Temperature range freely scalable

Power supply

24 VAC/DC ± 10 %

Output (linear / root extracted) ¹⁾	A	Measurement range	B
0..10 V (R _L ≥ 2 kΩ)	1	Measurement range e.g. 0..10 Pa, -10..50 mbar, ±100 mmHg (etc.)	
0..20 mA (R _L ≤ 500 Ω)	0		
4..20 mA (R _L ≤ 500 Ω)	4		

¹⁾ output signals can be configured freely

Margin of error	C	Contact points	D
± 0.2 % of max. value	2	none	0
± 0.5 % of max. value	5	2 relays (changeover contacts) max. 230 VAC, 6 A	2

Application	E
standard	A
P-/T-compensated volume flow	B

Tubing connectors	F
standard grommet for NW 4 or 6 mm tubing	0
threaded elbow connector for 6 mm tubing	W

Order code	A	B	C	D	E	F
P34	-	-	-	-	-	-

Can be pre-set on request:
Time constant, relay parameter, analogue output root-extracted / linear, deactivation of the cyclic zeroing

Features

- Differential pressure transmitter with very small dimensions – ideal for control cabinet installation
- Optional: P-/T-compensated volume flow (temperature analogue input and internal stat. pressure sensor)
- Optionally with relay
- Zero-point correction prevents zero-point drift
- Built-in valve provides a high level of overpressure protection
- Volume flow can be configured via k-factor, dP_{max}/V_{max} or 20 individual values
- USB interface²⁾: via PC-software scaling, characteristic line form and many other parameters can be set
- Free software available at www.halstrup-walcher.de/en/software
- Delivery possible already completely integrated into the control cabinet (on request)

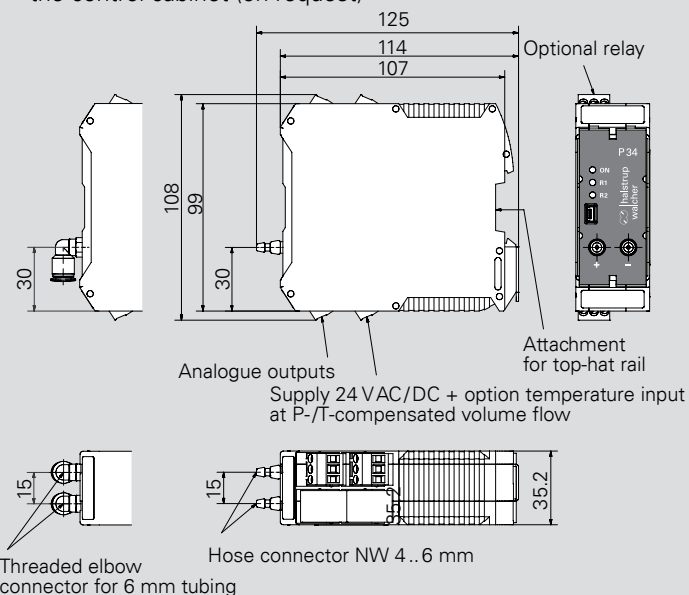

²⁾ Accessories: USB cable (Order no. 9601.0254)

Measurement ranges others available upon request	250/500 Pa 1/2.5/5/10/20/50/100 kPa freely scalable from 10..100 % within a measurement range
Margin of error (0.3 Pa margin of error for the reference)	±0.2 % of max. value or ±0.5 % of max. value
Temperature coefficient span	0.03 % of max. value/K (10..50 °C)
Temperature coefficient zero point	±0 % (cyclical zero-point correction)
Overload capacity	100 kPa for measurement ranges ≥ 2.5 kPa 200 x for measurement ranges < 2.5 kPa
Medium	natural gas
Max. system pressure	100 kPa for all measurement ranges
Sensor response time	25 ms
Time constants	25 ms..60 s (adjustable)
Operating temperature	10..50 °C
Storage temperature	-10..70 °C
Power consumption	approx. 6 VA
Weight	approx. 750 g
Cable glands	2 x M 16
Pressure ports	2 x laboratory nozzle DIN 12898
Protection class	IP 65
Certificates	CE, EN1127-1:2007

Output (linear/ root-extracted) ¹⁾	A
0..10 V (R _L ≥ 2 kΩ)	1
0..20mA (R _L ≤ 500 Ω)	0
4..20mA (R _L ≤ 500 Ω)	4
±5 V (R _L ≥ 2 kΩ)	5

Power supply	B
24 VDC ± 10 %	24 DC

¹⁾ output signals can be configured freely

Measurement range	C
Measurement range e.g. 0..250 Pa, -10..50 mbar, 0..100 mmHg (etc.)	

Margin of error	D
±0.2 % of max. value	2
±0.5 % of max. value	S

Display + keyboard	E
none	0
multi-coloured LCD and keyboard	LC

Tubing connections	F
standard for tubing NW 5..8 mm	0
cutting ring coupling 8 mm	S



Order code	A	B	C	D	E	F
P 29						

Can be pre-set on request:
Time constant, relay parameter, analogue output root-extracted / linear, deactivation of the cyclic zeroing

TÜV-tested

As long as the customer observes the specified flushing process, special electronic encapsulation safely separates any ignition sources from flammable gas.



Features

- TÜV-tested differential pressure transmitter for natural gas
- Design changes and technical modifications keep ignition source and gas mixture safely separated (not suitable for Ex-applications)
- Also ± measurement ranges
- Scalable measurement range and display
- For pressure and volume flow measurement
- Zero-point correction prevents zero-point drift
- Built-in valve provides a high level of overload protection
- Also suitable for top-hat rail mounting
- Multilingual menu (English/French/German/Italian)

P 29 with display

P 29 without display

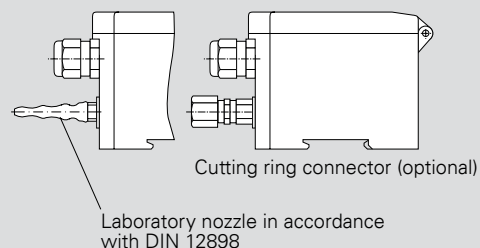
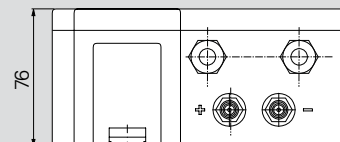
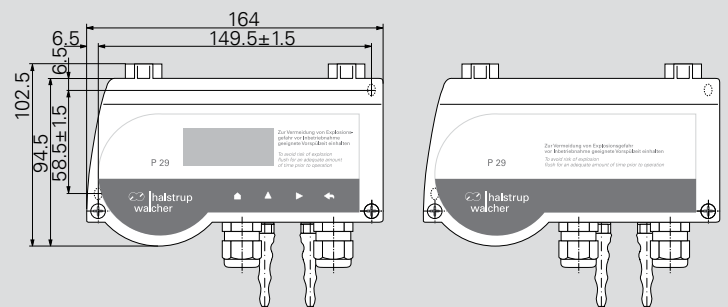



Features

- Differential pressure transmitter with linear curve for air-conditioning applications
- Also available as a two-wire system ("PIZ" model)
- Also for \pm measurement ranges and asymmetric measurement ranges
- With optional LCD

PU/PI with display

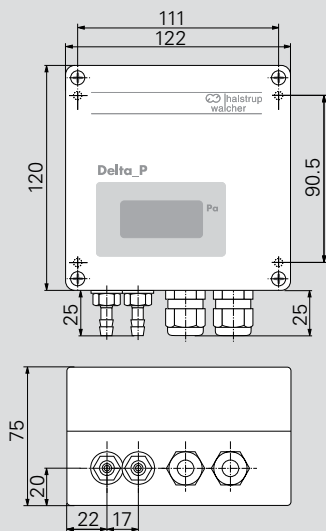

PU/PI without display

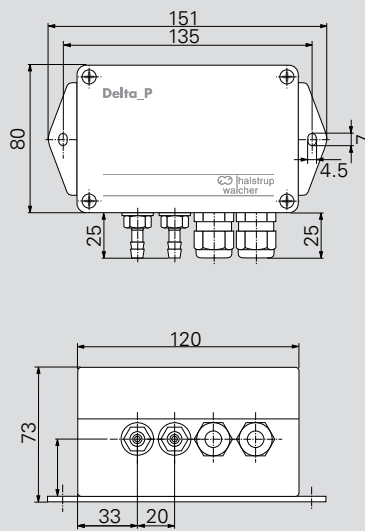

PIZ with display

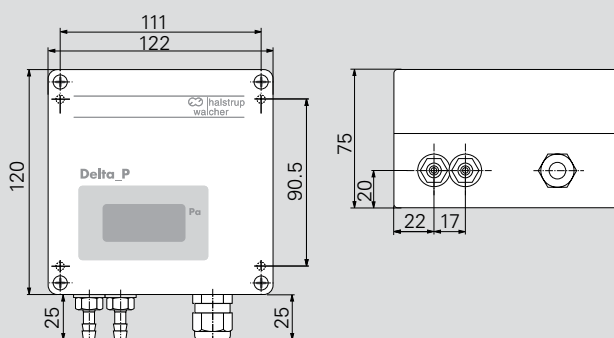

Measurement ranges (also \pm measurement ranges) others available upon request	50/100/250/500 Pa 1/2.5/5/10/20/50/100 kPa
Margin of error (0.3 Pa margin of error for the reference)	$\pm 0.2\%$ of max. value ¹⁾ only for measurement ranges ≥ 250 Pa $\pm 0.5\%$ of max. value ¹⁾ , $\pm 1\%$ of max. value
Temperature coefficient span	0.04 % of max. value/K (10..60 °C)
Temperature coefficient zero point	0.04 % of max. value/K (10..60 °C)
Zero point stability	0.5 % of max. value/year
Overload capacity	10 x for measurement ranges ≤ 20 kPa 2 x for measurement ranges > 20 kPa
Medium	air, all non-aggressive gases
Max. system pressure	10 kPa for measurement ranges ≤ 10 kPa max. nominal pressure of the sensor for measurement ranges above 10 kPa
Sensor response time	20 ms
Operating temperature	10..60 °C
Storage temperature	-10..70 °C
Power consumption	PU/PI: approx. 3 VA PIZ: max. 0.6 VA
Weight	approx. 0.8 kg
Cable glands others available upon request	PU/PI: 2xPG 7 PIZ: 1xPG 7
Pressure ports	for tubing NW 6 mm
Protection class	IP65
Certificates	CE, CSA (only for PU/PI)

Model	Output	A
PU	0..10 V ($R_L \geq 2$ k Ω)	U
PI	0..20 mA ($R_L \leq 500$ Ω)	I0
PI	4..20 mA ($R_L \leq 500$ Ω)	I4
PIZ	4..20 mA two-wire ($R_L \leq 50 [U_B (V) - 10 (V)] \Omega$)	IZ

Measurement range	B	Margin of error	C
Measurement range e.g. 0..100 Pa, 0..60 mbar, ± 110 mmHg (etc.)		$\pm 0.2\%$ of max. value ¹⁾ only for measurement ranges ≥ 250 Pa	02
		$\pm 0.5\%$ of max. value ¹⁾	05
		$\pm 1\%$ of max. value	1

¹⁾ not for PIZ with \pm measurement ranges

Supply voltage	D
24 VDC, +20 % / -15 % ²⁾	24D
24 VAC, +6 % / -15 % (50/60 Hz) ²⁾	24A
115 VAC, +6 % / -15 % (50/60 Hz) ²⁾	115
230 VAC, +6 % / -15 % (50/60 Hz) ²⁾	230
10..32 VDC (two-wire system)	PIZ

²⁾ not for PIZ

Time constant	E	LCD	F
none	0	none	0
1 s	1	3 1/2 digit (see foto)	3
2 s	2	4 1/2 digit (only for PU/PI)	4
5 s	5		

Order code	A	B	C	D	E	F
P	-	-	-	-	-	-

Scheda tecnica PU/PI/PIZ – Ultimo aggiornamento: 09/2017 – Con riserva di modifiche tecniche

Measurement ranges (also ± measurement ranges) others available upon request	50/100/200/500 Pa 1/2.5/5/10/20/50/100 kPa
Margin of error (0.3 Pa margin of error for the reference)	± 2 % of the set value for ≥ 100 Pa or ± 3 % of the set value for 50 Pa
Temperature coefficient span	0.1 % of max. value/K
Temperature coefficient zero point	0.1 % of max. value/K
Overload capacity	50 kPa for measurement ranges ≤ 2 kPa 200 kPa for measurement ranges > 2 kPa 500 kPa for measurement ranges > 10 kPa
Medium	air, all non-aggressive gases
Max. system pressure	10 kPa for measurement ranges ≤ 10 kPa max. nominal pressure of sensor for measurement ranges above 10 kPa
Sensor response time	20 ms
Time constants	20 ms..4 s adjustable (factory-provided)
Operating temperature	-20 .. 60 °C with Display 0 .. 50 °C
Storage temperature	-20 .. 70 °C
Power consumption	approx. 1 VA
Weight	approx. 0.25 kg
Cable glands	2 x M 12
Pressure ports	for tubing NW 4 or 6 mm
Protection class	IP 65
Certificates	CE

Output ¹⁾	A
0 .. 10 V (R _L ≥ 50 kΩ)	1
2 .. 10 V (R _L ≥ 50 kΩ)	2
0 .. 20 mA (R _L ≤ 500 Ω)	0
4 .. 20 mA (R _L ≤ 500 Ω)	4
0 .. 5 V (R _L ≥ 50 kΩ)	5

¹⁾ the output signal can be configured using jumpers

Measurement range	C
Standard ²⁾ (e.g. 0 .. 100 Pa)	
toggles between: 100 Pa/250 Pa/ 500 Pa/1 000 Pa	1
toggles between: 250 Pa/500 Pa/ 1 000 Pa/2.5 kPa	2
toggles between: 1 kPa/2.5 kPa/ 5 kPa/10 kPa	3
toggles between: 10 kPa/25 kPa/ 50 kPa/100 kPa	4

²⁾ others available upon request, also ± measurement ranges

Power supply	B
24 VAC/DC ± 10 % without galvanic separation	AC/DC
15 .. 32 VDC two-wire (only for A = 4)	ZWL

Contact point	D
none	0
1 relay (changeover contacts) max. 230 VAC, 6 A (min. required switching capacity 300 mW) (not for two-wire)	1

LCD	E
none	0
4-digit	1

Time constant	F
20 msec	20
30 msec	30
60 msec	60
120 msec	120
250 msec	250
500 msec	500
1 sec	1
2 sec	2
4 sec	4

Order code	A	B	C	D	E	F
PS27						

Relay parameter can be pre-set on request.



Features

- Compact differential pressure transmitter for basic applications
- ± measurement ranges and asymmetric measurement ranges
- Either with one fixed measurement range or toggling between 4 different measurement ranges (can be selected via jumpers, optional)
- Optionally with 2-wire technology (ZWL)
- With optional display
- With optional relay (6 A)
- Suitable for top-hat rail mounting and wall surface installation

PS 27 without display

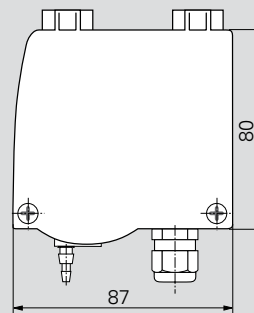

PS 27 with display

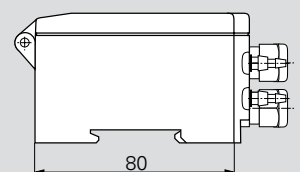
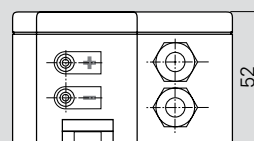
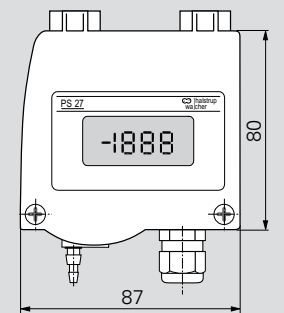



Features

- Pressure measurement and regulation in a device
- Accurate measurement of differential pressure with automatic zero-point correction and high overload protection
- Switching outputs can be used as 2-point regulator (pressure switch), for activating/deactivating a final control element (e.g. pump), with relay hysteresis
- Switching outputs can be used as a 3-point regulator (e.g. ON 1 - OFF - ON 2) for activating/deactivating two final control elements, (e.g. air intake/outflow fans), with relay hysteresis
- Asymmetry also possible, e.g. -10 .. 40 mbar
- Housing: control panel housing (installed)

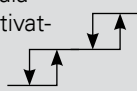

Panel housing / control panel installation

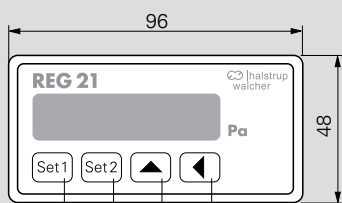

start and close settings
select values or parameters
call up parameter settings and display functions

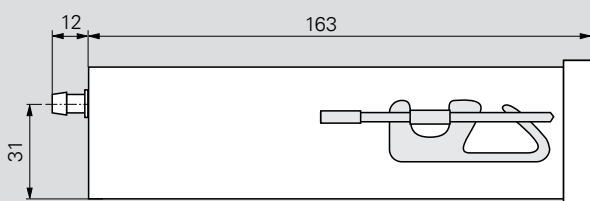

Measurement ranges others available upon request	50/100/250/500 Pa 1/2.5/5/10/20/50/100 kPa
Margin of error (0.3 Pa margin of error for the reference)	± 0.5 % of max. value or ± 1 % of max. value
Temperature coefficient span	0.04 % of max. value/K (10 .. 60 °C)
Temperature coefficient zero point	± 0 % (cyclical zero-point correction)
Overload capacity	200 x for measurement ranges < 2.5 kPa 600 kPa for measurement ranges ≥ 2.5 kPa
Medium	air, all non-aggressive gases
Max. system pressure	10 kPa for measurement ranges ≤ 10 kPa max. nominal pressure of sensor for measurement ranges above 10 kPa
Sensor response time	20 ms
Display	4 ½ digit
Time constants	adjustable up to 10 s
Operating temperature	10 .. 60 °C
Storage temperature	-10 .. 70 °C
Power consumption	approx. 5 VA
Weight	approx. 0.8 kg
Pressure ports	for tubing NW 6 mm
Protection class	IP 50 (installed)
Certificates	CE

Output	A
0.. 10 V ($R_L \geq 2 \text{ k}\Omega$)	1
± 5 V ($R_L \geq 2 \text{ k}\Omega$)	5
0.. 20 mA ($R_L \leq 500 \Omega$)	0
4.. 20 mA ($R_L \leq 500 \Omega$)	4

Measurement range	B
Measurement range (e.g. 0..100 Pa, -10..40 mbar, 0..200 mmHg etc.)	

Margin of error	C
± 0.5 % of max. value	05
± 1 % of max. value (standard)	1

Power supply	D
24 VDC, +20 % / -15 %	24D
24 VAC, +6 % / -15 % (50/60 Hz) (with galvanic separation)	24A
115 VAC, +6 % / -15 % (50/60 Hz)	115
230 VAC, +6 % / -15 % (50/60 Hz)	230

Contact points	E
2 relays with floating changeover contacts 230 VAC (50/ 60 Hz), 6 A	R
2 transistors with open collector $U_{CE} \leq 50 \text{ V}$; $I_C \leq 200 \text{ mA}$, floating	T

Order code	A	B	C	D	E
REG 21	-	-	-	-	-

Can be pre-set on request:
Time constant, relay parameter,
deactivation of the cyclic zeroing

DISPLAY PANELS

for process monitoring

PANLES FOR DISPLAYING, ALERTING, NETWORKING

Many companies (e.g. in the life sciences sector) are required to use monitoring systems in their critical production processes. These systems have to operate with a high degree of data security and record, transfer and save quality-relevant measurement data. Professional suppliers of monitoring systems and validation services offer solutions which are aligned with GAMP 5 for this task. GAMP stands for *Good Automated Manufacturing Practice*. It is a quasi-standard that sets out the requirements for computer-aided systems in a regulated pharmaceuticals environment.

One important task of monitoring processes is to make measurement data available in the locations where local decisions depend on them. halstrup-walcher display panels are the optimum solution for this task:

Product	PUC 44	PUC 24	PUC 28 (K)
Details on	p. 24 + p. 25	p. 14	p. 15
			
Special features	Multi-channel process display with touch screen - Values, curves, bar graph, vector can be displayed - 4 alarms per channel - Modbus/BACnet connection	Cleanroom panel with integrated differential pressure sensor for climate data display, temperature/humidity measuring transmitter can be connected	Process panel with integrated differential pressure sensor for climate data display, temperature/humidity measuring transmitter can be connected
Application	Process monitoring for cleanrooms and control cabinets (machines, plants)	Process monitoring for cleanrooms (Pa, °C, % rF)	Process monitoring panel (optional: with calibration connection) (Pa, °C, % rF)
Measurement Range	Up to 4 external analogue values of any phys./chem. values	± 100 or ± 250 Pa, freely scalable within this range, % rF/°C: Depending on the connected measuring transmitter	
Degree of measurement uncertainty	Depending on the connected measuring transmitters	Differential pressure on board: 0.5 % of max. value (standard) (0.3 Pa margin of error for the reference)	
Display	Touch-display (TFT), coloured, 3,5", 320x240 pixels	LED-display, 3 lines	
Alerting	Visually/acoustically, cf. p. 24	Relay outputs, acoustic alarm	
Networking	Modbus RTU, BACnet MS/TP	RS 232, PROFIBUS DP (both optional)	

ACCESSORIES

Accessories for PUC24 and PUC28(K) on p. 11.

Parameterisation PUC44 ¹⁾

On-site parameterisation (PUC44) according to customer specifications

Order-No.

in the order key cf. p. 25

Installation PUC44 ²⁾

Flush-mounted box for masonry wall installations ³⁾

9601.0188

¹⁾ The parameterisation of the PUC44 takes place via the intuitive touch menu. It can be performed by the commissioner without further training.

²⁾ All PUC series devices have been specifically designed for installation in cleanroom walls and thus have a minimal installation depth. The versions PUC44-2/-3 and PUC24 also feature a hygienic design. A recessed socket is not required for cleanroom installations. It is used for mounting the types PUC44-1 and -2 in brick walls.

³⁾ Recessed area for plastering the flush-mounted box into the wall: 160 mm x 160 mm, 75 mm (width x height, depth)



PROCESS MONITORING FOR CLEANROOMS AND CONTROL CABINETS WITH THE PUC44

For optimum integration into cleanroom walls, the PUC44 cleanroom panel can be supplied with two different stainless steel fronts. Their slim design allows both to be installed in the cleanroom wall. As an alternative to the standard model, another high quality version with enhanced cleanability and magnetic mounting is also available. A version with a simple aluminium front can be used at installation sites in control cabinet fronts and outside cleanroom environments.



Features

- Multi-channel process display with touch screen
 - For *high-end cleanroom* applications (PUC44-3)
 - For *standard cleanroom* applications (PUC44-2)
 - For *control cabinet* installation (PUC44-1)
- Display of up to **4 values** (any phys./chem. values) in one display, free designation of the channels
- The configuration is available in multiple languages with menu controls and touch operation (without parametrisation software). It can be performed in the factory or by the commissioner.
- Type of display freely selectable: values, curves (adjustable time axis, max. 7 days), vector and bar
- 4 individual alarms can be defined for any input: LoLo/Lo/Hi/HiHi. The alarm signal is displayed as text with optional colour change for as long as the alarm continues.
- If the sensor signal is outside the permitted range (below the alarm "LoLo" or above the alarm "HiHi") the background colour will turn red (freely configurable parameter).
- If the sensor signal threatens to leave the permitted range (i.e. signals below "Lo" or above "Hi"), the background colour will change, e.g. to yellow (freely configurable parameter).
- If the sensor value is OK, the background colour is not noticeable.
- In addition to the alphanumeric value, a small bar graph shows the percentage of the defined measurement range currently utilised.
- A collective alarm of previously defined individual alarms triggers an acoustic signal. The acoustic alarm is acknowledged and switched off by touching the screen.
- Any user can change between approved views and switch off the collective alarm. No password is required to do this.
- Access to the configuration process is protected by a one-level password with at least 6 digits (GAMP 5).
- The device does not log data (no logging function). This simplifies validation.
- The current input and alarm signals are available via Modbus RTU or BACnet MS/TP.

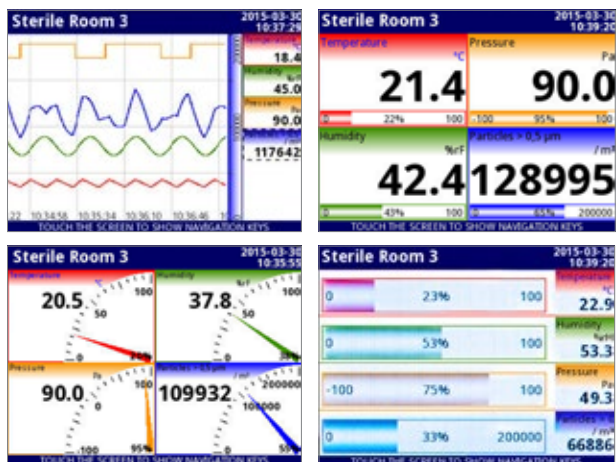
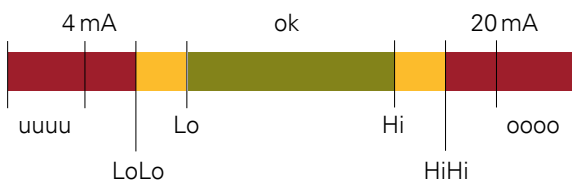



PUC 44 - 3

PUC 44 - 1/-2

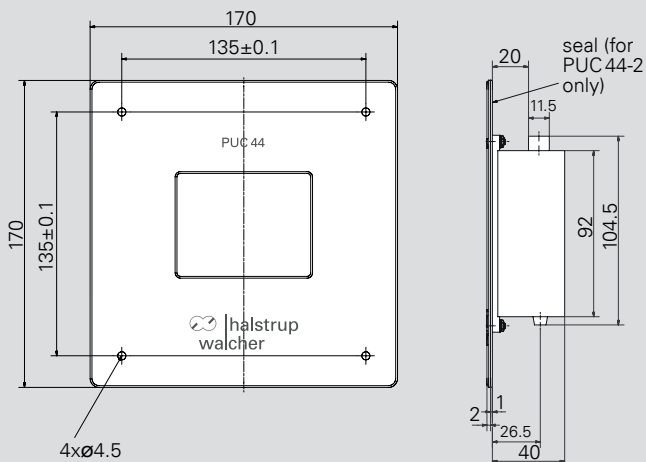

PUC 44 - 3

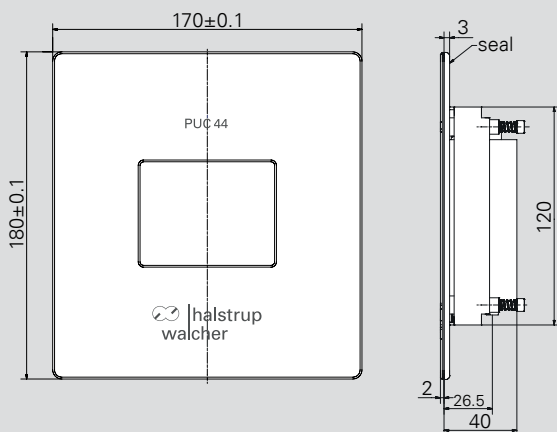

Inputs (adjustable)	up to 4 analogue inputs (4..20 mA, galvanically separated, Ra=400..1750Ω), without transmitter feed
Scaling (adjustable)	deactivated, linear or polygonal (max. 20 points)
Filter	deactivated or with dampening/ filter coefficient
Touch-display	TFT, coloured, 3.5", 320x240 px
Available views (adjustable)	values, bar graph, curve chart, vector diagram
View change	manually or automatically
Time axis curve chart	19s/48s/95s/3 min/6 min/12 min/30 min/1 h/2 h/4 h/8 h/16 h/24 h/3 d/7 d
Alarm configuration (adjustable)	LoLo..Lo..Hi..HiHi for all channels thresholds: constant, lower threshold, upper threshold, hysteresis timing: delay ON/OFF, retention time ON/OFF acoustic collective alarm freely parameterisable
Alarm display (adjustable)	deactivated, permanent, flashing (period, retention time, alarm source, texts/colours adjustable)
Languages (menu)	English, French, German, Italian, Spanish
Date and time	time zone and summer time can be set
Brightness	20..40..60..80..100 %
Screen saver	deactivated or after 1..5..10..30 min
Access protection	password 6-digit (GAMP 5)
Current consumption	500 mA
Baud rate	1200 bit/s to 115200 bit/s
Connections	1x USB-host on the rear for transfer of configuration files, screw terminals for 4 analogue inputs, bus and supply
Power supply	24 VDC ± 5 %
Housing	wall recessing
Ambient temperature	0..50 °C
Storage temperature	-10..70 °C
Humidity	5..90 % without condensation
Protection class PUC 44 - 1	IP20
Protection class PUC 44 - 2/-3	IP65 (front side), IP20 (housing and terminals)

Housing type	A	Bus type / data interface	B
Aluminium anodised	1	Modbus RTU	MB
Stainless steel standard	2	BACnet MS/TP	BN
Stainless steel with magnetic holder	3		

Parameterisation	C
Provided by customer	0
Factory-provided ¹⁾	1

¹⁾ according to specified parameter list

Order code	A	B	C
PUC 44	-	-	-

Portable

**DIGITAL
PRESSURE
GAUGES**

DIGITAL PRESSURE GAUGES

Product	EMA 200	EMA 84
Details on	p. 28	p. 29
		
Features	Portable digital pressure gauge with min./max. value memory and free selection of units, also suitable for flow measurements	Rugged, portable digital pressure gauge
Measurement ranges	± 200 Pa (± 2 mbar) ± 2 kPa (± 20 mbar) ± 20 kPa (± 200 mbar) ± 200 kPa (± 2 000 mbar)	0.. 100 Pa (0.. 1 mbar) 0.. 1 kPa (0.. 10 mbar) 0.. 10 kPa (0.. 100 mbar) 0.. 100 kPa (0.. 1 000 mbar)
Margin of error (0.3 Pa margin of error for the reference)	± 0.5 % of max. value	± 0.2 % of max. value for measurement ranges 1.. 50 kPa or ± 0.5 % of max. value for measurement ranges 1.. 100 kPa or ± 1 % of max. value

The EMA 200 can be ordered in 4 different measurement ranges. The units can be changed as required: Pa and kPa are shown in the display; mbar, mmH₂O, and in H₂O are printed on the housing film and marked with an arrow. The temperature or rate of flow is shown in a second line on the display.

The EMA 84 can also be ordered with 4 different measurement ranges. The following units may be selected: Pa/mbar and mbar/kPa.

ACCESSORIES

Shoulder bag EMA 200
Carrying bag EMA 84
Shoulder bag EMA 84 (with LCD viewing window)
DAkkS calibration certificate, German (p. 42)
DAkkS calibration certificate, English (p. 42)
ISO factory calibration certificate
Connecting components (tubing etc.)
Telescoping pitot tube for flow measurements (EMA 200)

Order no.
9074.0001 ①
9063.0001 ②
9064.0001 ③
9601.0003
9601.0004
9601.0002
see p. 11
9061.0193 ④

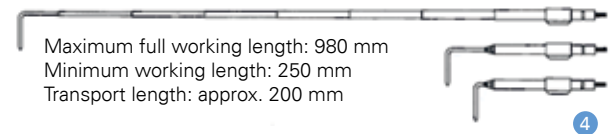

USE OF HANDHELD GAUGES

After the start-up of an air-conditioning system or cleanroom, or during maintenance or validation work, it is necessary to monitor a large number of pressure values. It is therefore essential to measure and record the following values accurately:

- ventilator pressure
- pressure drop at power units and filters
- overpressure in the cleanroom
- flow in the air duct and rooms

The EMA range of hand-held pressure gauges has been optimised for long-term use in building services engineering and industrial applications. They are rugged and simple to operate.



Margin of error (0.3 Pa margin of error for the reference)	± 0.5 % of max. value
Overload capacity	10 X for measurement ranges ≤ 10 kPa 2 X for measurement ranges > 10 kPa 1.2 X in the 200 kPa measurement range
Calculation of air speed	$v = 1.291 \cdot \sqrt{\Delta p}$ with v in m/s and Δp = differential pressure at the pitot tube in Pa (pitot factor and density adjustable) with telescoping pitot tube, see p. 27
Zero-point correction	performed electronically by pressing zero-point key
Medium	air, all non-aggressive gases
Analog output	0..2 V ($R_L \geq 2 \text{ k}\Omega$) 0..1..2 V ($R_L \geq 2 \text{ k}\Omega$) for negative and positive measurement ranges
Display	3½ digit LCD, character height = 10 mm
Time constants	1..10 s
Operating temperature	0..50 °C
Storage temperature	-10..70 °C
Power supply	9V battery (service life approx. 100 h) (display reads "low bat" when power falls below a certain minimum level); Switches off automatically after approx. 20 min.
Weight	approx. 0.4 kg
Pressure ports	for tubing NW 4 or 6 mm
Certificates	CE

Measurement range			A
±200 Pa	(±2 mbar)	1.5..18 m/s	0
±2 kPa	(±20 mbar)	5..58 m/s	1
±20 kPa	(±200 mbar)	15..180 m/s	10
±200 kPa	(±2000 mbar)		100

Order code	A
EMA 200	—



Features

- High-end pressure gauge for differential pressure and flow measurements
- Adjustable pitot factor and density
- Zero-point correction at the push of a button
- Min./max. value memory
- Temperature measurement

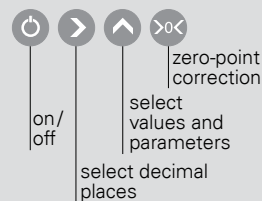
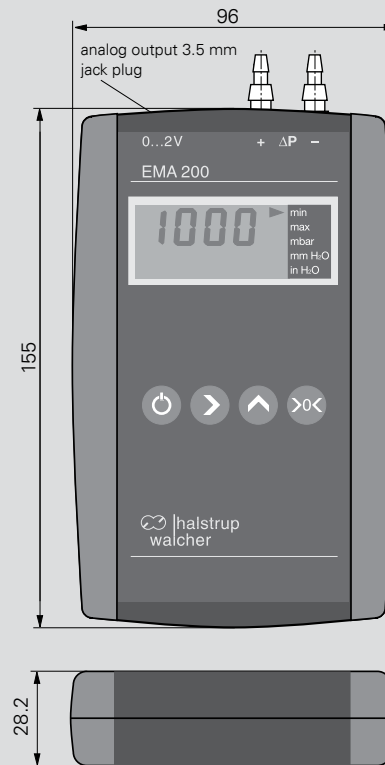

Connection diagram

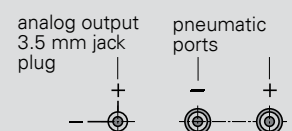



Features

- Very robust digital pressure gauge
- Ideal for service technicians, easy-to-read display
- High level of accuracy
- Manual zero-point correction
- With optional analog output for writer or power/voltage logger

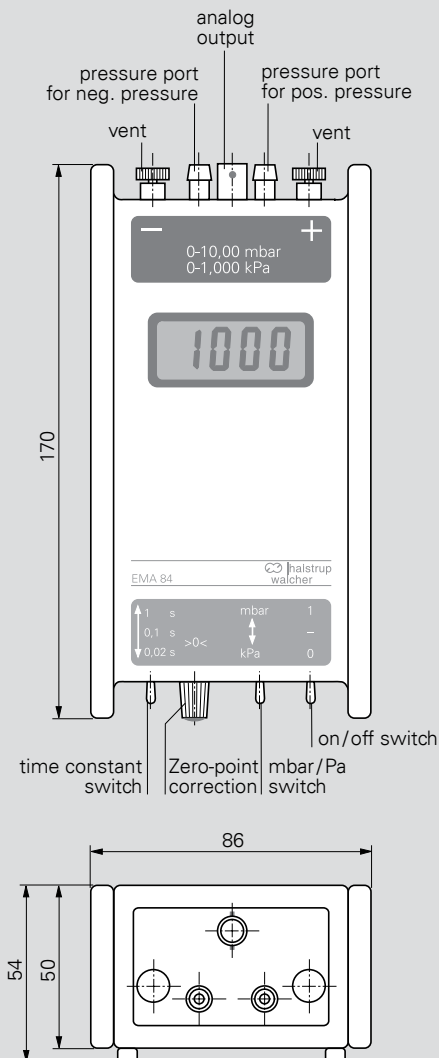

Margin of error (0.3 Pa margin of error for the reference)	± 0.2 % of max. value for measurement ranges 1 .. 50 kPa or ± 0.5 % of max. value for measurement ranges 1 .. 100 kPa or ± 1 % of max. value
Overload capacity	10 x for measurement ranges ≤ 10 kPa 2 x for measurement ranges > 10 kPa
Zero-point correction	via potentiometer on front face
Medium	air, all non-aggressive gases
Analog output	0..1 V (R _L ≥ 2 kΩ) BNC connector
Display	3 ½ digit LCD, character height = 13 mm
Time constants	toggles between 0.02 s; 0.2 s; 1 s
Operating temperature	10..60 °C
Storage temperature	-10..70 °C
Operating position	preferably horizontal
Power supply	9 V battery
Weight	approx. 0.8 kg
Pressure ports	for tubing NW 6 mm
Certificates	CE

Measurement range		A
0.. 100 Pa	(0.. 1 mbar)	0
0.. 1 kPa	(0.. 10 mbar)	1
0.. 10 kPa	(0.. 100 mbar)	10
0.. 100 kPa	(0.. 1 000 mbar)	100

Margin of error	B
± 0.2 % of max. value for measurement ranges 1..50 kPa	2
± 0.5 % of max. value for measurement ranges 1..100 kPa	5
± 1 % of max. value	1

Analog output	C
none	0
0..1 V (optional)	1

Order code	A	B	C
EMA 84	-	-	-

ABSOLUTE PRESSURE TRANSMITTERS

ABSOLUTE PRESSURE TRANSMITTERS

Absolute pressure measurements are essential for determining atmospheric pressure. Here, the current pressure is compared with a vacuum. Atmospheric pressure measurements record (weather-dependent) ambient pressures, i.e. approx. 1 013.25 hPa ± 50 hPa. Absolute pressure measurements are also able to compare other pressure values to the vacuum – depending on the selected pressure range (e.g. 75 hPa).

Product	AD 1000	BA 1000
Details on	p. 32	p. 32
		
Features	Absolute pressure transmitter	Atmospheric pressure transmitter
Measurement range	0 .. 50 kPa 0 .. 100 kPa 80 .. 120 kPa 90 .. 110 kPa 100 .. 0 kPa	80 .. 120 kPa 85 .. 115 kPa 90 .. 110 kPa 95 .. 115 kPa
Margin of error	± 1 % of measurement range Reference ± 0.5 hPa with respect to sea level	
Display	3 ½ digit, see foto (optional) 4 ½ digit (optional)	

ACCESSORIES

	Order no.
DAkKS calibration certificate, German (see p. 42)	9601.0003
DAkKS calibration certificate, English (see p. 42)	9601.0004
ISO factory calibration certificate	9601.0002
Connecting components (tubing etc.)	see p. 11

APPLICATION

Weather forecasting is one area where it is vital to be able to measure atmospheric pressure accurately. Air-conditioning systems, too, often measure the current level of atmospheric pressure in order to avoid excessive differences in pressure, e.g. in entrance areas/air curtains.

Precise measurements of absolute pressure are also vital in many scientific and production processes – wherever it is essential to have a (weather-independent) process pressure value. This is frequently required, e.g. for pressure compensation of volume flow measurements.



Margin of error (0.3 Pa margin of error for the reference)	± 1% of measurement range Reference ± 0.5 hPa with respect to sea level
Temperature coefficient span	0.04 %/K (10..60°C)
Calibration temperature	22°C
Operating temperature	10..60°C
Storage temperature	-10..70°C
Signal stability	0.3 hPa/year
Reduction	0..850 m above sea level (please indicate when placing your order)
Power consumption	approx. 3 VA
Cable glands	2 x PG 7 (housing without display) 2 x PG11 (housing with display)
Protection class	IP 54
Weight	approx. 0.6 kg
Pressure ports ¹⁾	for tubing NW 6 mm
Certificates	CE

¹⁾AD 1000: 1 pressure port, BA 1000: no pressure port

Product	Measurement range	A
AD 1000	0..50 kPa	50A
	0..100 kPa	100A
	80..120 kPa	80A
	90..110 kPa	90A
	100..0 kPa	0A
BA 1000	80..120 kPa	80B
	85..115 kPa	85B
	90..110 kPa	90B
	95..115 kPa	95B

Output	B
0..10 V ($R_L \geq 2 \text{ k}\Omega$)	1
0..20 mA ($R_L \leq 500 \Omega$)	0
4..20 mA ($R_L \leq 500 \Omega$)	4

Power supply	C
24 VDC, +20 %/-15 %	24D
24 VAC, +6 %/-15 % (50/60 Hz)	24A
115 VAC, +6 %/-15 % (50/60 Hz)	115
230 VAC, +6 %/-15 % (50/60 Hz)	230

LCD	D
none	0
3 ½ digit, see foto	3
4 ½ digit	4

Reduction ²⁾	E
none	0
please indicate in meters (e.g. 2 m) ²⁾	

²⁾only for BA 1000

Order code	A	B	C	D	E
AD-BA 1000	-	-	-	-	-



Features

- Precise absolute pressure transmitter
- AD: for absolute pressure
- BA: for atmospheric pressure
- High level of accuracy and long-term stability
- Little zero-point drift or hysteresis; largely independent of temperature
- The size of the optional display can be adjusted (reduced) in the factory to correspond to the height of the installation site, see DIN ISO 2533 (only BA 1000)

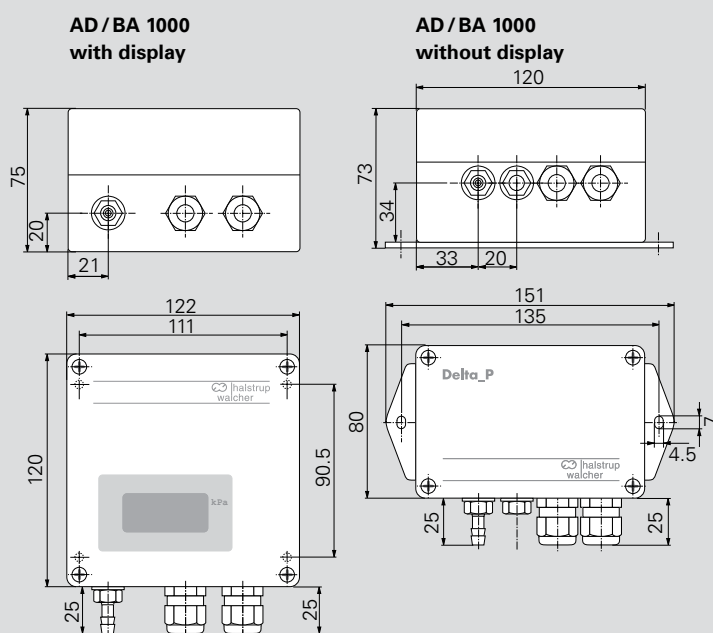

AD 1000: 1 pressure port
BA 1000: no pressure port

Pressure calibration



**MOBILE
CALIBRATION
DEVICES**

HIGH PRECISION ON-SITE MEASUREMENT AND CALIBRATION

The KAL range from halstrup-walcher offers 3 pressure calibration devices which offer outstanding value for money and can be used either for stationary (e.g. in a customer's own laboratory) or mobile applications. These devices combine the following features:

- integrated pressure generation (for setting the calibration point)
- high-precision pressure measurement

In the KAL 84, the pressure is generated using a manual pump and integrated pressure bellows. In the KAL 100/200, the calibration point (target pressure) is entered via the keyboard. A high precision pump automatically generates the target pressure. The user can select not only the display language but also the unit of pressure.

Product	KAL 200	KAL 100	KAL 84
Details on	p. 36	p. 36	p. 37
			
Pressure generation	automatic		manual
Applications	mobile or stationary (laboratory)		
Measurement ranges	0..100 Pa/0..200 Pa/0..500 Pa/0..1 kPa/0..2 kPa/ 0..5 kPa/0..10 kPa/0..20 kPa/0..50 kPa/0..100 kPa/ ±100 Pa/±200 Pa/±500 Pa/±1 kPa/±2 kPa/±5 kPa/ ±10 kPa/±20 kPa/±50 kPa/-80..100 kPa		0..100 Pa (0..1 mbar) 0..1 kPa (0..10 mbar) 0..10 kPa (0..100 mbar) 0..100 kPa (0..1000 mbar) 0..300 mmHg (0..400 mbar)
Margin of error (0.3 Pa margin of error for the reference)	± 0.1 % of max. value Measurement ranges > 0.200 Pa/±200 Pa ± 0.2 % of max. value Measurement ranges 0..200 Pa/±200 Pa ± 0.3 % of max. value Measurement ranges 0..100 Pa/±100 Pa	± 0.2 % of max. value Measurement ranges > 0.200 Pa/±200 Pa ± 0.5 % of max. value Measurement ranges ≤ 0.200 Pa/±200 Pa	± 0.2 % of max. value ± 1 digit Measurement ranges 0..50 kPa ± 0.5 % of max. value ± 1 digit
Interface	USB (standard)	USB (optional)	-
Analog measurement input for test object	✓	optional	-
Battery life (rechargeable)	8 h	8 h	2 h
Factory calibration certificate	✓	optional	optional

USER SOFTWARE FOR THE KAL 100/200

Control calibration processes from your PC.

The KAL 100/200 calibration devices with USB port can be operated using our user software. You have a choice of three operating modes: target value mode, pressure measurement and test mode.

Define calibration points and run to them automatically. Once you have saved a defined calibration run, you can use it again for another or the same pressure transmitter.

You can also use the software to set parameters which you would otherwise set using the display's operating menu (unit, language, zero-point adjustment,...).

You can find the free user software at:

www.halstrup-walcher.de/en/software

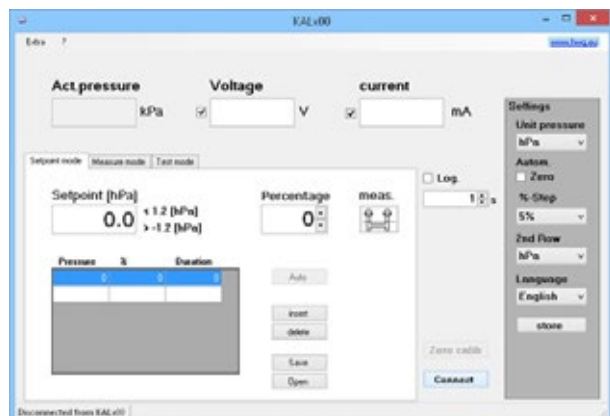

ACCESSORIES

Carrying bag KAL 84
 Hand pump KAL 84
 Transport case KAL 100/200
 Carrying bag KAL 100/200
 DAkkS calibration certificate, German
 DAkkS calibration certificate, English
 ISO factory calibration certificate

Order no.
 9062.0001 **1**
 9601.0036 **2**
 9220.0002 **3**
 supplied as standard
 9601.0003 (see p. 42)
 9601.0004 (see p. 42)
 9601.0002 (included for KAL 200)



Hand pump KAL 84
 Order no. 9601.0036



Carrying bag KAL 84
 Order no. 9062.0001



Transport case KAL 100/200
 Order no. 9220.0002



Carrying bag KAL 100/200
 supplied as standard

APPLICATIONS FOR THE KAL CALIBRATION DEVICE

Eliminate the time and expense of sending your pressure gauges to an external calibration laboratory. KAL uses a rechargeable battery and is therefore ideal for mobile applications. KAL enables you to calibrate pressure gauges yourself. However, if you wish to use the calibration device as a reference, it should be calibrated by DAkkS.

The KAL range provides the optimum solution for the following typical (mobile or stationary) applications:

- calibration of differential pressure gauges in cleanrooms (pharma, semiconductors etc.)
- calibration of blood pressure monitoring equipment in hospitals etc.
- calibration of differential pressures in air-conditioning systems

EFFICIENT ON-SITE CALIBRATION OF BLOOD PRESSURE MONITORS

Every hospital and nursing home now uses blood pressure monitors. These devices must be accurate and reliable. They must operate over months and years without deviation and are calibrated annually. During this process, the measured value from the blood pressure monitor is compared with a highly accurate reference value.

Calibrations of this type can be performed efficiently: technical service staff can calibrate blood pressure monitors on-site rather than removing them from hospital wards to be sent to external calibration laboratories. This eliminates costs for logistics and shipping times.

The KAL 200 from halstrup-walcher is battery-powered and the perfect tool for this important task. The PC software enables you to pre-program and save pressure sequences. The KAL 200 pressure generator accurately generates the *target pressure* – the actual value is read from the blood pressure monitor. The actual values are entered directly on-site into standardised test protocols which you can manage in the hospital's or nursing home's building management software. The data are now available at any time.



In practice: Blood pressure monitors in the nursing home Solina in Spiez (Switzerland) are calibrated by the technician responsible.

Margin of error KAL 100 (0.3 Pa margin of error for the reference)	± 0.2 % of max. value Measurement ranges > 0..200 Pa / ±200 Pa ± 0.5 % of max. value Measurement ranges ≤ 0..200 Pa / ±200 Pa
Margin of error KAL 200 (0.3 Pa margin of error for the reference)	± 0.1 % of max. value Measurement ranges > 0..200 Pa / ±200 Pa ± 0.2 % of max. value Measurement ranges 0..200 Pa / ±200 Pa ± 0.3 % of max. value Measurement ranges 0..100 Pa / ±100 Pa
Hysteresis	0.1 % of max. value
Overload capacity	600 kPa for measurement ranges > 3 kPa 200 X for measurement ranges ≤ 3 kPa
Temperature coefficient zero point	± 0 % (cyclical zero-point correction)
Temperature coefficient span	KAL 100: 0.04 % of max. value / K (10..40 °C) KAL 200: 0.03 % of max. value / K (10..40 °C)
Calibration temperature	22 °C
Medium	air, all non-aggressive gases
Measurement input/ power supply (test object)	0..10 V, 0/4..20 mA Accuracy: 0.2 % of max. value 24 VDC/100 mA
Display	Alphanumeric display with 2 x 20 characters, backlighting
Operating temperature	10..40 °C
Storage temperature	-10..70 °C
Weight	approx. 4.5 kg
Pressure ports	Ø 6 mm, for tubing NW 5 mm
Certificates	CE

Model	A
KAL 100	100
KAL 200	200

Power supply	C
115 VAC, 6 % / -15 % (50/60 Hz)	1
230 VAC, 6 % / -15 % (50/60 Hz)	2
115 VAC, 6 % / -15 % (50/60 Hz) and rechargeable lithium ion battery	1A
230 VAC, 6 % / -15 % (50/60 Hz) and rechargeable lithium ion battery	2A

Data interface	D
none	0
USB + measurement input for test object (standard for KAL 200)	1

Measurement ranges	B
0..100 Pa	0
0..200 Pa	02
0..500 Pa	05
0..1 kPa	1
0..2 kPa	2
0..5 kPa	5
0..10 kPa	10
0..20 kPa	20
0..50 kPa	50
0..100 kPa	100
±100 Pa	0A
±200 Pa	02A
±500 Pa	05A
±1 kPa	1A
±2 kPa	2A
±5 kPa	5A
±10 kPa	10A
±20 kPa	20A
±50 kPa	50A
-80..100 kPa	100A

Order code	A	B	C	D
KAL	-	-	-	-



Features

- High precision measurement and calibration device
- Runs on mains supply or battery, highly flexible (optional)
- Battery life approx. 8 hours, ideal for mobile applications
- Automatic zero-point correction provides high zero-point stability
- Internal pump quickly and accurately generates negative or positive differential pressures of up to 100 kPa
- Optional USB interface available (Standard for KAL 200)
- Factory calibration certificate supplied as standard (KAL 200)
- Unit conversion (e.g. mmHg, mmH₂O, psi, etc.)
- Multilingual menu (English/French/German/Italian/Spanish)
- With power supply and measurement input for the external test object (transmitter being calibrated)

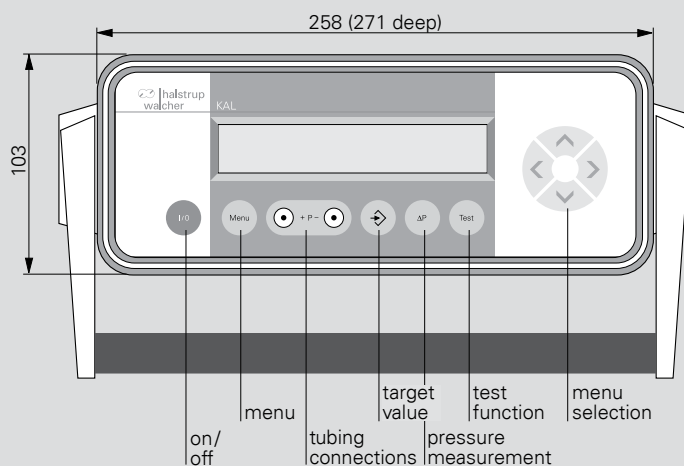



Margin of error ¹⁾ (0.3 Pa margin of error for the reference)	$\pm 0.2\%$ of max. value + ± 1 digit for measurement ranges 1..50 kPa $\pm 0.5\%$ of max. value + ± 1 digit
Hysteresis	0.1 % of max. value
Temperature coefficient zero point	not applicable; Push button for resetting zero-point
Temperature coefficient span	0.04 % of max. value/K (10.. 40 °C)
Calibration temperature	22 °C
Medium	air, all non-aggressive gases
Displacement volume	approx. 100 cm ³ (1, 10, 100 kPa) approx. 200 cm ³ (100 Pa)
Analog output	0.. 1 V ($R_L \geq 2$ k Ω) 2 connectors \varnothing 4 mm
Display	4 ½ digit LCD character height = 10 mm
Time constants	toggles between 0.1 s; 1 s
Operating temperature	10.. 40 °C
Storage temperature	- 10.. 70 °C
Power supply	NiCd rechargeable 9 V battery with AC adaptor
Weight	approx. 3 kg
Pressure ports	for tubing NW 6 mm
Certificates	CE

¹⁾ all measurement ranges have a 99 % overrange.

Measurement ranges ²⁾	A
0.. 100 Pa (0.. 1 mbar)	0
0.. 1 kPa (0.. 10 mbar)	1
0.. 10 kPa (0.. 100 mbar)	10
0.. 100 kPa (0.. 1 000 mbar)	100
0.. 300 mmHg (0.. 400 mbar)	300

²⁾ others available upon request

Margin of error	B
$\pm 0.5\%$ of max. value ± 1 digit	1
$\pm 0.2\%$ of max. value ± 1 digit for measurement range 1..50 kPa (optional)	2

Power supply	C
230 VAC adaptor	230
115 VAC adaptor	115

Order code	A	B	C
KAL 84	-	-	-

Features

- Highly accurate and reproducible results
- Internal pressure generation using pressure bellows and hand pump
- Very rugged and light:
excellent for service applications
- Unit conversion, e.g. mmHg/kPa, mbar/kPa
- Rechargeable battery allows for portable operation

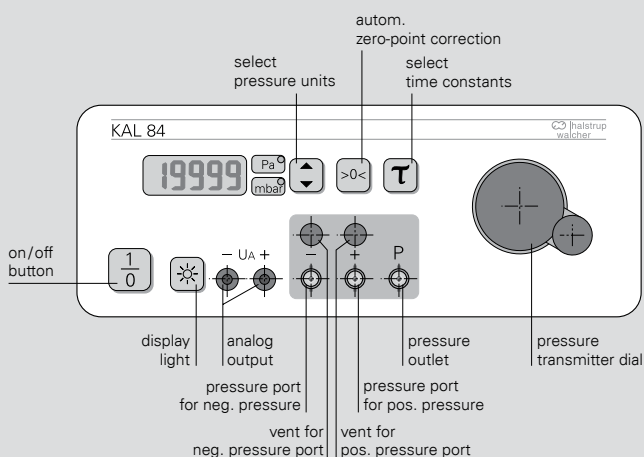
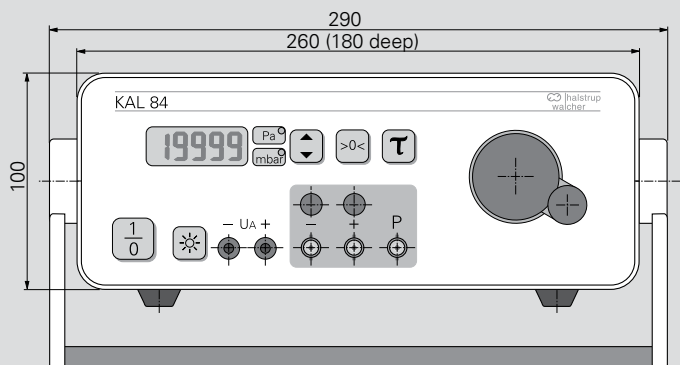

In air ducts and processes

MEASUREMENT OF VOLUME FLOWS

VOLUME FLOW MEASUREMENT

In building and process technology, it is necessary to measure the quantities of air flowing into rooms or processes or being circulated in the plant. The quantity of air transported in a given period of time is known as the volume flow (most common unit: m³ or ft³ per hour). Accuracy to the last decimal point is usually not critical in these applications. The key features are reliability, robust build quality and good value for money.

The most commonly used method of measuring volume flows is based on the principle of differential pressure. This has a number of specific advantages:

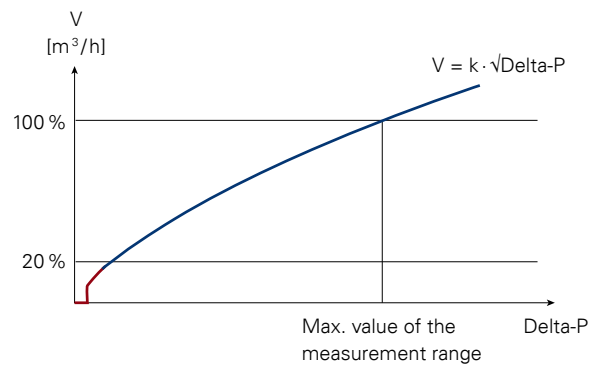

- low investment costs, especially for ducts with medium or large cross-sections
- minimal calibration costs
- process technology: Also suitable for use in plants where the temperature deviates significantly from the room conditions

The differential pressure method of measuring volume flow cannot accurately record very small volume flows. These low measurement values are therefore suppressed (*creep suppression*), e.g. the lowest 3% of the differential pressure measurement range. However, in typical air conditioning and ventilation systems, as well as in most process technology plants, the volume flows lie between 20 and 100% of the maximum measurement range so this does not result in any significant limitations.



SUITABLE DEVICES

halstrup-walcher offers a selection of high quality pressure transmitters with root extracted output. Please select a primary element to complete the measurement point (see p.40). To ensure that the theoretical design of the measurement equipment matches the practical application, we offer calibration of the complete system in our flow rate calibration laboratory (see p.43) – with a factory calibration or DAkkS calibration certificate.

Product	P26	P34	P29
Details on	p. 16	p. 17	p. 18
			
Special feature	Scalable, large selection of units	Similar to P26, specifically designed for the control cabinet	Similar to P26, can be used in applications with natural gas
Volume flow & Differential pressure	✓	✓	✓
Volume (consumption)	✓ (optional, see p.40)	-	-
Accuracy	✓✓	✓✓	✓✓
Pressure / temperature compensation	-	✓ (optional: Absolute pressure sensor on board, temperature analogue input)	-
20-point curve	-	✓ (can be stored)	-

CONVERSION TABLE

	m ³ /h	m ³ /min	ft ³ /h	ft ³ /min
m ³ /h	1	0.0167	35.3147	0.5886
m ³ /min	60	1	2 118.8800	35.3147
ft ³ /h	0.0283	0.0005	1	0.0167
ft ³ /min	1.6990	0.0283	60	1

Please read the lines from left to right.
Example: 1 m³/h corresponds to 35.3147 ft³/h.

SELECTION OF THE PRIMARY ELEMENTS

The primary element can be redesigned and supplied by halstrup-walcher. In addition, our differential pressure transmitters can be coupled with an existing, pre-installed primary element. Talk to us. Here is a short description of the process and the information we need:

Complete package of primary element and differential pressure transmitter from halstrup-walcher:

- Customer data: max. volume flow [m^3/h or ft^3/h] and air duct dimensions (width x height or diameter)¹⁾
- halstrup-walcher: Selection of the differential primary element, calculation of the max. differential pressure, selection of the appropriate measurement range for the differential pressure transmitter

¹⁾ **Process technology:** Please also state the air temperature and pressure.

Pre-installed primary element + differential pressure transmitter:

- Customer data: max. volume flow [m^3/h or ft^3/h] and the associated max. differential pressure¹⁾
- halstrup-walcher: selection of the differential pressure transmitter measurement range over this max. differential pressure value

P 26 AIR METER/MEASUREMENT OF AIR CONSUMPTION

It is very rare to calculate the consumption data for the individual users of an air-conditioning system. Costs are often assigned by dividing the total costs by the area occupied by the respective tenant. For example, if a tenant rents 23 % of the total area, he will also pay 23 % of the air-conditioning costs. Particularly in commercial properties with a number of tenants, air consumption is often viewed in the same way as other consumables (electricity, water).

There is a need for a fairer assignment of costs based on actual consumption. The same applies to industrial companies with an energy management system.

The P 26 air meter takes the following approach: Based on the volume flow measurement using the principle of differential pressure, the P 26 air meter adds up and displays the volumes consumed (m^3 of air) and makes the data available via a pulse output.

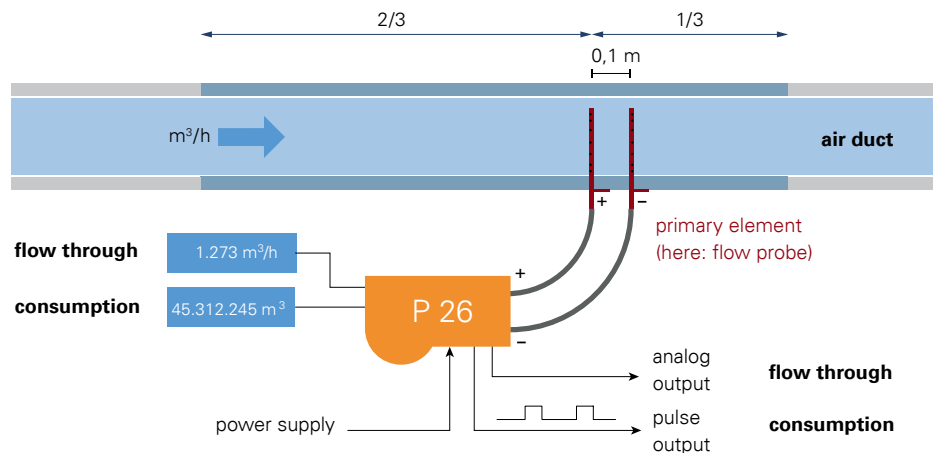

AIR METER FEATURES

- Security: code-protected function, no unauthorised operation
- The total consumed (and a meter recording the operating hours) can be reset after entering a code either to zero or to a "total before reset" saved as a backup.
- The pulse valency (m^3 per pulse), pulse length and pulse interval can be set separately
- An internal meter recording the operating hours provides a time reference – operational security without batteries.

Technical data P26 and order code: see p. 16.



Calibration of
pressure and volume flow

CALIBRATION SERVICES

CALIBRATION SERVICES

CALIBRATION TO MAINTAIN QUALITY STANDARDS

To ensure that an instrument provides accurate measurements, regular calibrations are necessary. Calibration means to operate a target-performance comparison using a measuring instrument and a traceable reference. Calibration of instruments is essential in every area where sensitive measurement technology is used, e.g. in the manufacturing of sensors. It is the only way to guarantee quality standards and prevent defects arising in processes and products from the outset. For companies wanting to attain ISO 9001 certification, regular calibration of testing equipment is a requirement.

PRESSURE CALIBRATION IN THE LABORATORY

Since 1999 our calibration laboratory has been accredited by the German calibration service DKD and Deutsche Akkreditierungsstelle GmbH (DAkkS) in accordance with DIN EN ISO/IEC 17025 – among other things for calibration of pressure measurements. Its calibration services are available for all makes of equipment independently of the type and manufacturer. Our high precision reference objects, used during calibration, are calibrated at regular intervals at the PTB and therefore traceable to the national standard.

Overview of services for pressure measurements at our calibration laboratory:

- Calibration of differential pressure transmitters, calibration instruments, absolute pressure transmitters and portable pressure gauges
- **Absolute pressures** of 0.25 bar to 20 bar in gases (laboratory medium: air or nitrogen)
- Negative and positive **gauge pressure** of -10 mbar to 20 bar in gases (laboratory medium: air or nitrogen)
- Issuing of DAkkS certificates (German or English, coverage always both)

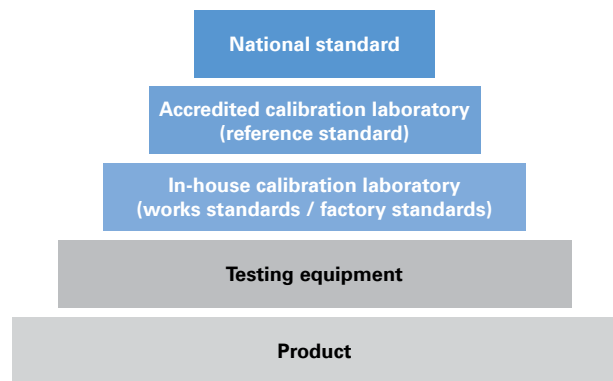

DAkkS calibration laboratory of halstrup-walcher

DAKKS CALIBRATIONS

DAkkS calibration should be performed at measurement points which are critical to the quality of the product or service.



It follows a recognised, standardised procedure (e.g. in accordance with DKD-R 6-1) and the uncertainty of the calibration is stated. The DAkkS certificate is internationally recognised and documents seamless traceability to national standards.

ISO FACTORY CALIBRATIONS

ISO factory calibration is suitable for instruments used as auxiliary devices for reference measurement and development purposes, e.g. in management of reference materials in accordance with ISO 9001.

In contrast to the DAkkS calibration, the ISO factory calibration does not state the uncertainty. ISO factory calibrations are performed in the production laboratory of halstrup-walcher using traceable references.

As an additional service, halstrup-walcher also performs adjustments to its own pressure transmitters.

VOLUME / MASS-FLOW CALIBRATION IN THE LABORATORY

halstrup-walcher operates a calibration laboratory accredited by the Deutsche Akkreditierungsstelle GmbH in accordance with DIN EN ISO/IEC 17025 to guarantee the correct functioning of measurement systems. It is approved for calibrating a variety of measurements including flow rate (volume flow/mass flow) of the medium air.

The reference value for the laboratory is a **maximum flow velocity of 10 m/s**. The test facility is therefore perfectly designed for the calibration of measurement systems for air conditioning and process air ducts.

YOUR ADVANTAGES AT A GLANCE

- ✓ Objective calibrations based on the differential pressure principle and independent of the manufacturer
- ✓ Observation of the flow profile across the full cross-section of the duct, not a point-specific measurement
- ✓ Short throughput times → calibration objects are quickly available for operation
- ✓ Express service (on request)

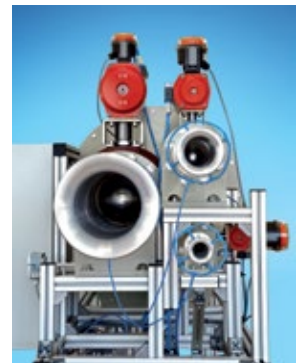

High precision inlet nozzles for accurate measurement results

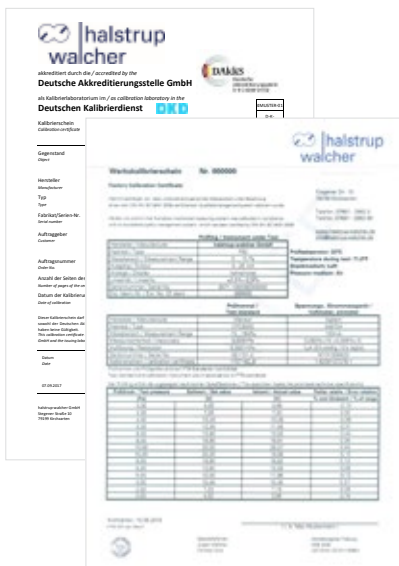

PERFORMANCE OVERVIEW

Performance overview of our calibration lab for the measured value volume and mass flow:

- Volume flow of at least 25 m³/h up to max. 4500 m³/h
- Mass flow of 30 to 5400 kg/h
- Channel diameters of 50 to 700 mm

DAKKS- AND ISO-CALIBRATION OF:

- Volume flow meters (installed in the pipe section)
- Balometers, primary elements (k-factor), ventilator fans
- Complete volume flow measuring sections (channel or pipe section with primary element and differential pressure transmitter, e.g. P34 can be calibrated at up to 20 points), see also p. 17.

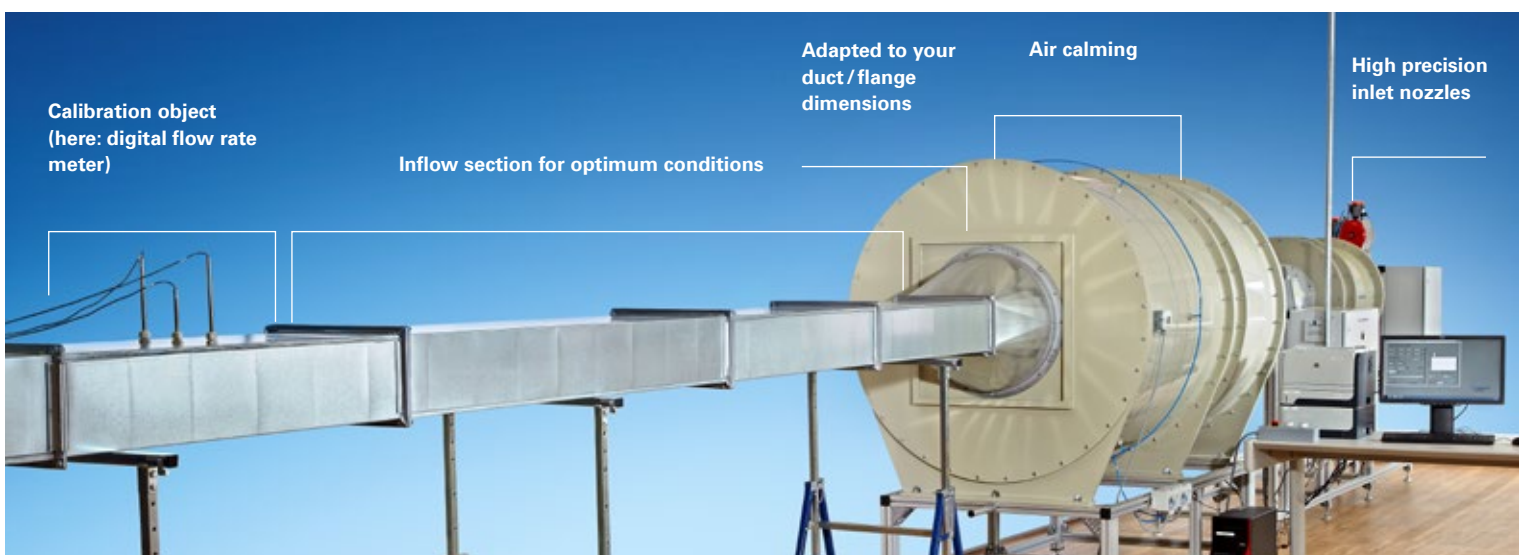

Calibration object
(here: digital flow rate meter)

Inflow section for optimum conditions

Adapted to your duct / flange dimensions

Air calming

High precision inlet nozzles

halstrup-walcher GmbH
Stegener Str. 10
79199 Kirchzarten
Germany

Tel. +49 (0) 76 61 3963-0
Fax +49 (0) 76 61 3963-99
www.halstrup-walcher.com
info@halstrup-walcher.de

**Austria / Croatia / Serbia /
Hungary / Slovenia**

Industrie Automation Graz
Ing. W. Häusler GmbH
Autaler Str. 55
8074 Raaba
Austria
Tel. +43 (0) 316 405 105
Fax +43 (0) 316 405 105-22
office@iag.co.at
www.iag.co.at

Australia / New Zealand

Bestech Australia Pty. Ltd.
Unit 14, 44 Garden Blvd,
Dingley, VIC 3172
Australia
Tel. +61 (0) 3 9540 5100
Fax +61 (0) 3 9551 5541
Enquiry@bestech.com.au
www.bestech.com.au

**Belgium / Luxembourg /
Netherlands**

DIMED nv
Joe Englishstraat 47
2140 Antwerpen
Belgium
Tel. +32 3 236 6465
Fax +32 3 236 6462
info@dimed.be
www.dimed.eu

China

Shanghai Yu Ting
Room 602, No. 45, Alley 1661,
Jia Luo Road, Xu Hang Town,
Jiading District, Shanghai
Tel. +86 21 6915 3366
Fax +86 21 6915 3939
ch-sys@ch-sys.net
www.ch-sys.net

Denmark

Hans Buch A/S
Roskildevej 8-10
2620 Albertslund
Tel. +45 43 68 50 00
Fax +45 43 68 50 50
info@hansbuch.dk
www.hansbuch.dk

Great Britain / Ireland

OMNI SENSORS
AND TRANSMITTERS Ltd.
The Old Barn, Churchlands
Business Park, Ufton Road,
Harbury, Warwickshire
CV33 9GX
England
Tel. +44 (1926) 614263
Fax +44 (1926) 612888
sales@sensorsandtransmitters.com
www.sensorsandtransmitters.com

India

Parshvi Technology
Shop No : 10, Block A, Ground
Floor, Pushp Business Campus,
S P Ring Road, Vastral
AHMEDABAD 382418
GUJARAT
Tel. +91 8128705212
ram@parshvitechnology.com
www.parshvitechnology.com

Italy

halstrup-walcher S.r.l.
Viale Colleoni, 15
(Palazzo Orione, 2)
20864 - Agrate Brianza (MB)
Tel. +39 0399630880
Fax +39 0399630883
info@halstrup-walcher.it
www.halstrup-walcher.it

Japan

Krone Corporation
3-9-6 Higashishinkoiwa
Katsushika-ku, Tokyo
Tel. +81 (0) 3 3695 5431
Fax +81 (0) 3 3695 5698
sales-tokyo@krone.co.jp
www.krone.co.jp

South Korea

NOVA INSTRUMENT CO., LTD
ITECO 769, Jojung-daero 150,
Hanam-Si, Gyeonggi-do,
Tel. +82 (31) 8028 9936
Fax +82 (31) 8028 9937
nova@novainstrument.com
www.novainstrument.com

Sweden

DJ Stork Automation AB
Karlsbodavägen 39
168 67 Bromma
Tel. +46 (0) 8 635 6030
Fax +46 (0) 8 635 6031
stork@storkautomation.se
www.storkautomation.se

Switzerland

Swissfilter AG
Gewerbstrasse 3
5037 Muhen
Tel. +41 (0) 62 737 5480
Fax +41 (0) 62 737 5481
info@swissfilter.ch
www.swissfilter.ch

Turkey

CAGDAS Automation
& Engineering Co. Ltd.
Kizilay cad. 28006 sok No: 5
01010 Seyhan / Adana
Tel. +90 322 359 81 85
Fax +90 322 359 36 39
cagdas@cagdasltd.com.tr
www.cagdasltd.com.tr

Taiwan

Chih Horng Scientific Co., Ltd.
6F, No.69-5, Sec. 2,
Zhongzheng E. Rd.,
Tamsui Dist.,
New Taipei City 251
Tel. +886 (02) 2808 0169
Fax +886 (02) 2808 0176
chih.mail@msa.hinet.net
www.ch-sys.com

USA

Intelligent Measurement Solutions LLC
7801 Clinton-Macon Road
49236 Clinton, MI
Tel. +1 (616) 608 7919
Tel. +1 (734) 637-1596
Fax +1 (616) 608 7954
darrell@i-m-solutions.net
www.h-wusa.com