

CLAMPS



PULL CLAMPING SYSTEM

**PULL CLAMPING SYSTEM
HOOK TYPE**

OD / ID CLAMPS

CLAMPS

CLAMPS



PULL CLAMPING SYSTEM

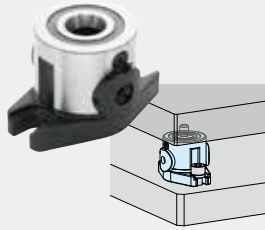

CLAMPING MODULES (Flanged)

Part No. CP150

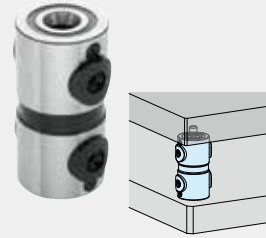

CLAMPING MODULES (Double)

Part No. CP151

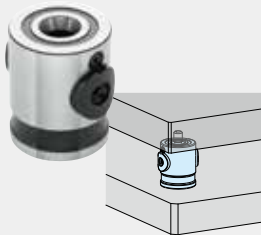

CLAMPING MODULES (Single)

Part No. CP152

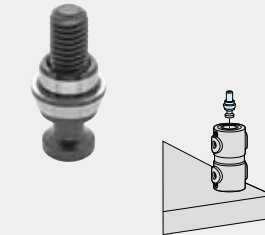

TAPERED CLAMPING SCREWS (Round)

Part No. CP155-L

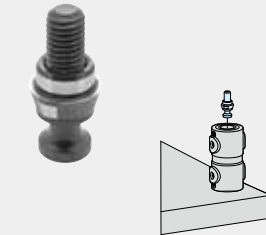

TAPERED CLAMPING SCREWS (Diamond)

Part No. CP155-D

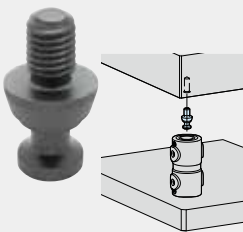

CLAMPING SCREWS

Part No. CP156

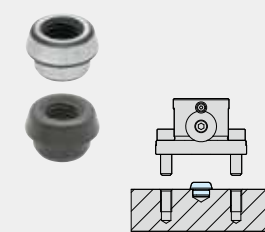

TAPERED BUSHINGS

Part No. CP157

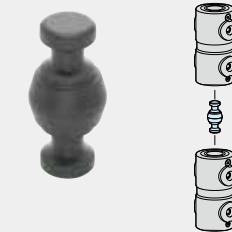

DOUBLE TAPERED CLAMPING PINS

Part No. CP158

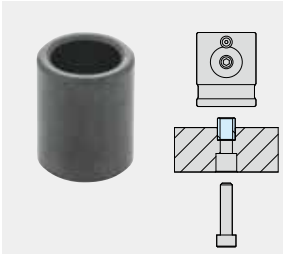

LOCATING BUSHINGS

Part No. CP159

PULL CLAMPING SYSTEM HOOK TYPE

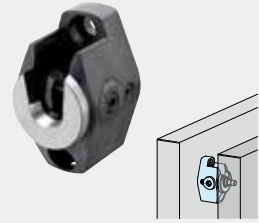

CLAMPING MODULES (Hook)

Part No. CP160



TAPERED CLAMPING SCREWS (Hook)

Part No. CP165-LH



TAPERED CLAMPING SCREWS

Part No. CP165-L



CLAMPING SCREWS (Hook)

Part No. CP166-H



CLAMPING SCREWS

Part No. CP166

OD / ID CLAMPS

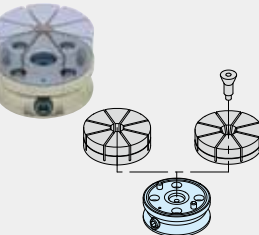

FORM HOLDING CLAMPS

Part No. CP125

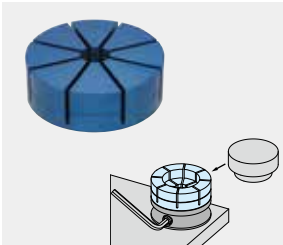

JAWS FOR EXTERNAL FORM HOLDING

Part No. CP126



JAWS FOR INTERNAL FORM HOLDING

Part No. CP127



TAPERED SCREWS FOR INTERNAL FORM HOLDING

Part No. CP127-B

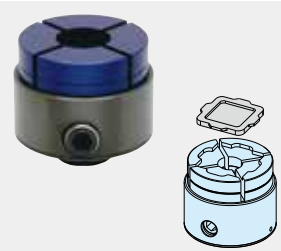

OD HOLDING CLAMPS

Part No. CP120

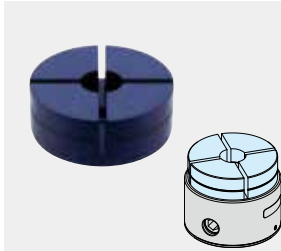

JAWS

Part No. CP121

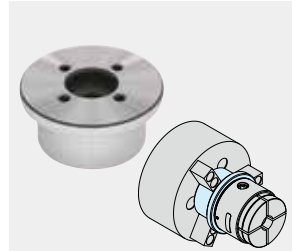

MOUNTING-ON-LATHE ADAPTERS

Part No. CP122

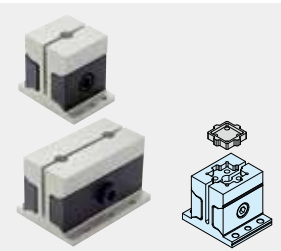

OD HOLDING CLAMPS (Wedge Style/Square)

Part No. CP124



OD HOLDING CLAMPS (Wedge Style/Round)

Part No. CP123

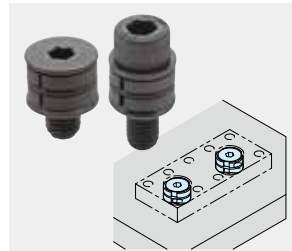

COMPACT ID HOLDING CLAMPS

Part No. CP131

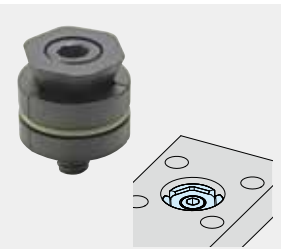

ID HOLDING CLAMPS

Part No. CP130

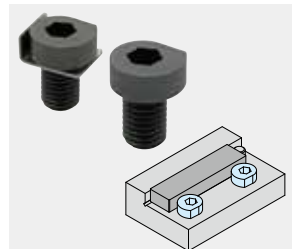

SPIRAL CAM CLAMPS

Part No. CP135

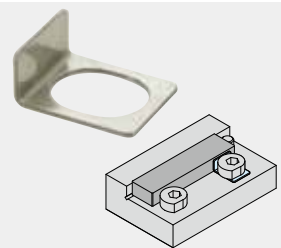

CLAMPING PLATES

Part No. CP135-P

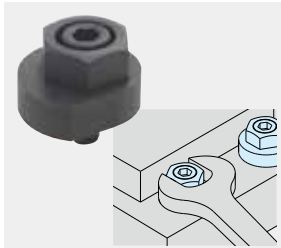

CAM CLAMPS

Part No. BJ161

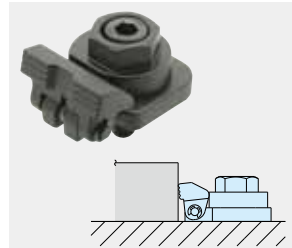

CAM EDGE CLAMPS

Part No. BJ162

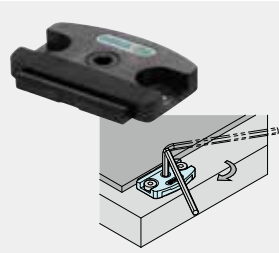

COMPACT LOW-PROFILE CAM EDGE CLAMPS

Part No. QLSCL

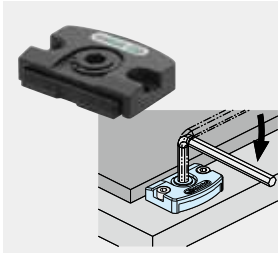

LOW-PROFILE CAM EDGE CLAMPS

Part No. QLSCL-NR

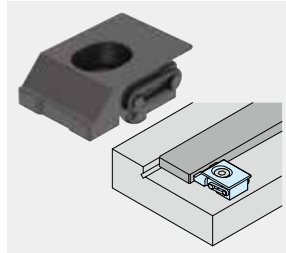

COMPACT TOE CLAMPS

Part No. CP133

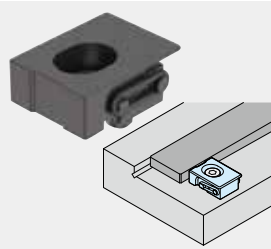

COMPACT SIDE CLAMPS

Part No. CP134

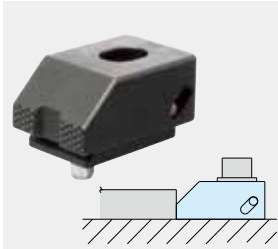

TOE CLAMPS

Part No. CP106

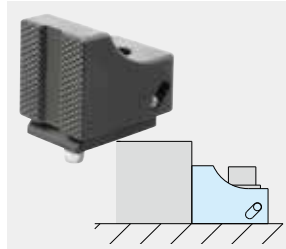

SIDE CLAMPS

Part No. CP107

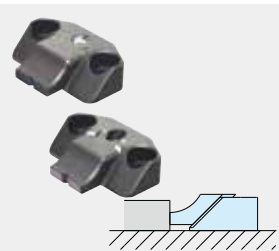

TOE CLAMPS

Part No. CP104

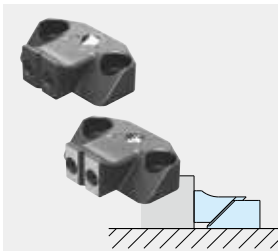

SIDE CLAMPS

Part No. CP105

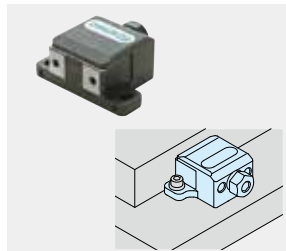

SIDE CLAMPS

Part No. QLSCH-H

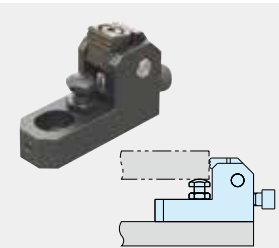

SIDE CLAMPS

Part No. CP100

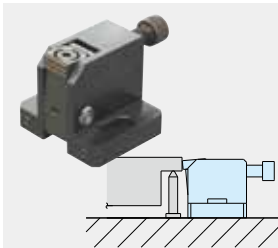

SIDE CLAMPS

Part No. CP101

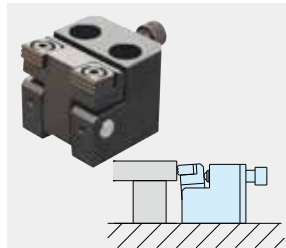

WIDE-JAW SIDE CLAMPS

Part No. CP102

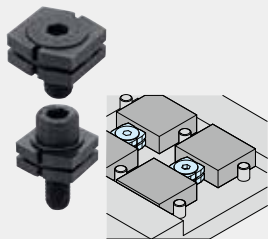

COMPACT WEDGE CLAMPS

Part No. CP132

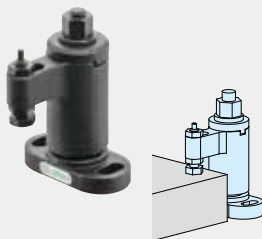

SWING CLAMPS FOR TORQUE CONTROL

Part No. QLSWC

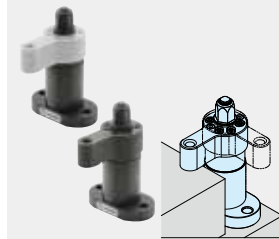

SWING CLAMPS (Quick-Acting)

Part No. PTSW1

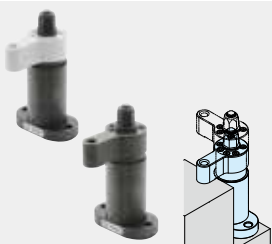

SWING CLAMPS (Spiral-Acting)

Part No. PTSW2

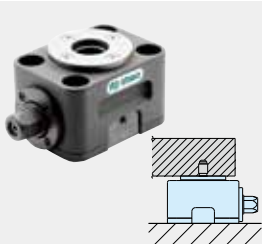

BLOCK PULL CLAMPS

Part No. PTPD

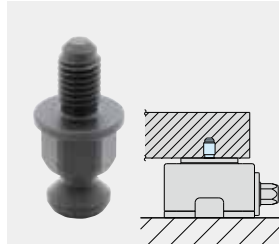

CLAMPING SCREWS FOR BLOCK PULL CLAMPS

Part No. PTPD-M

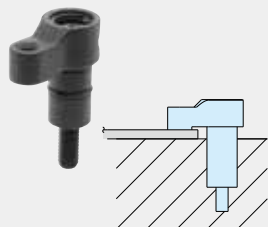

HOOK CLAMPS

Part No. BJ132

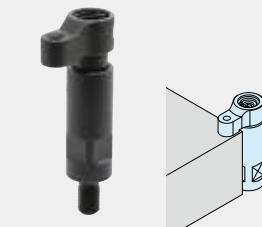

HOOK-CLAMP ASSEMBLIES

Part No. BJ132-A

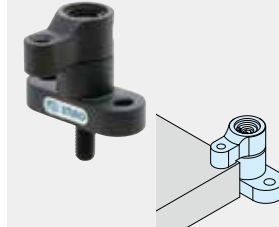

HOOK-CLAMP ASSEMBLIES WITH FLANGED HOLDER

Part No. BJ132-B

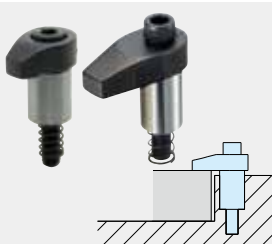

HOOK CLAMPS

Part No. BJ130

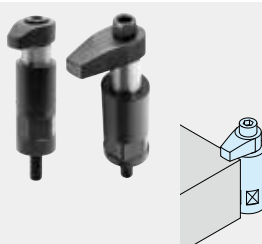

HOOK-CLAMP ASSEMBLIES

Part No. BJ130-A

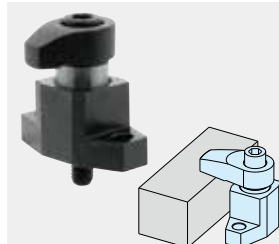

HOOK-CLAMP ASSEMBLIES (Flanged)

Part No. BJ130-B1

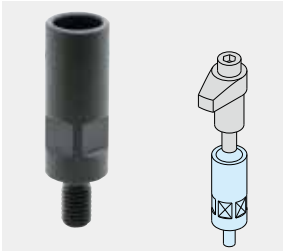

HOOK-CLAMP HOLDERS

Part No. BJ530

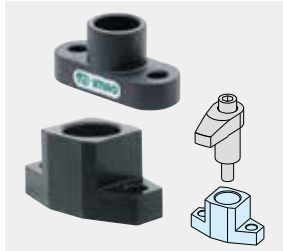

HOOK-CLAMP HOLDERS
(Flanged)

Part No. BJ531

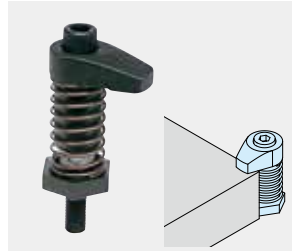

HOOK CLAMPS

Part No. BJ131

MODULAR PULL CLAMPING SYSTEM

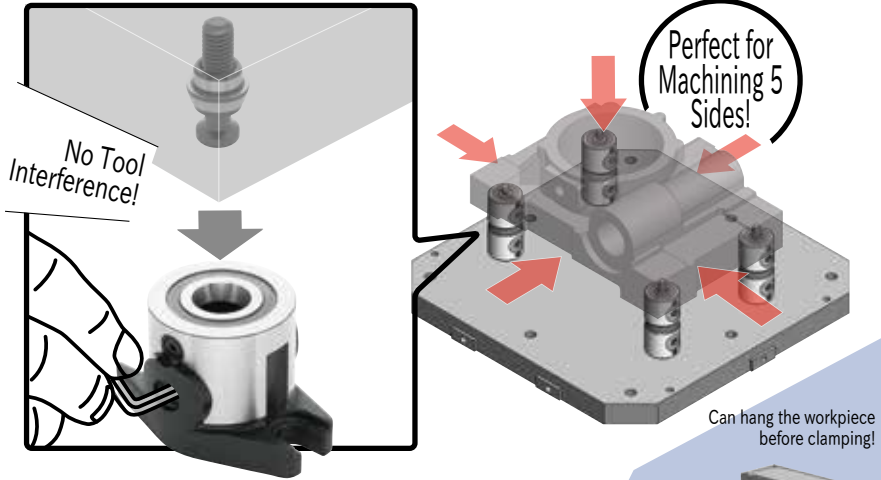

New Style of Pull Clamps! MODULAR PULL CLAMPING SYSTEM

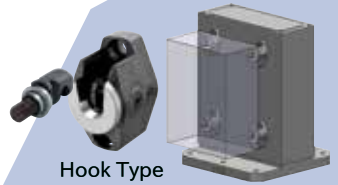

The cylindrical body allows machining 5 sides without tool interference!
Dual surface contact of the tapered surfaces provides 5 μm locating repeatability!

Single Setup!
Full access to 5 sides without tool interference!

Mechanical Zero Point Clamping!
Quick and precise fixture changing!

Simple workholding !

Better Machining Accuracy	Shorter Fixture Preparation Time
Lower Fixture Cost	No Tool Interference



Fixture Improvement

Before

Many setups with vise

Improvement

Single Setup

Before

Pull clamping with screws (Using riser blocks)

Improvement

Easy Clamping Operation

Before

Pull clamping with screws (Using fixture plate)

Improvement

Eliminating Interference with Fixture Plate

After

Without fixture plate

Mounting clamping screws directly on workpiece

With fixture plate

Mounting clamping screws on fixture plate

Quick Fixture Change

Quick and precise fixture change

No need of mounting holes
Full space is available for fixture parts.

Modular Fixture

Can be used as a universal fixture by standardizing the mounting hole location.

Universal Fixture

Custom fixture plate with 50mm pitch holes

Dimensions: 350, 150, 450, 350

Workpiece Raising

Prevent tool interference

Easy chip cleaning

Before

After

How To Use Modular Pull Clamping System

Assembly Chart

The system consists of 10 kinds of components. Please refer to the table on the next page for details of each component.

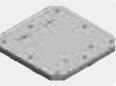
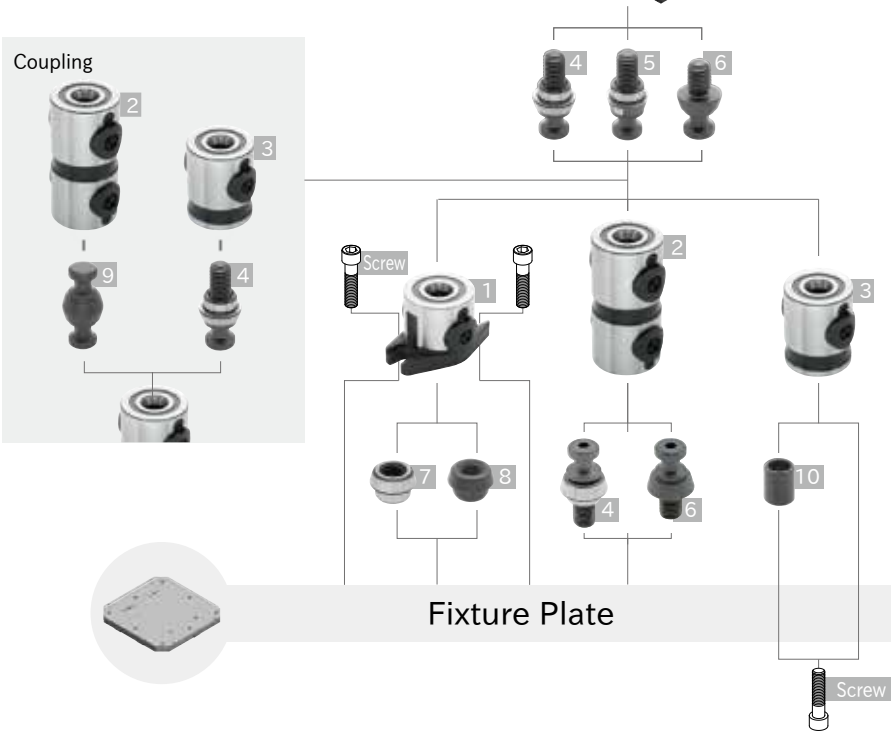

Operation

Install clamping screw on the workpiece and mount it on clamping module. Tighten the locking screws on the side of clamping module.

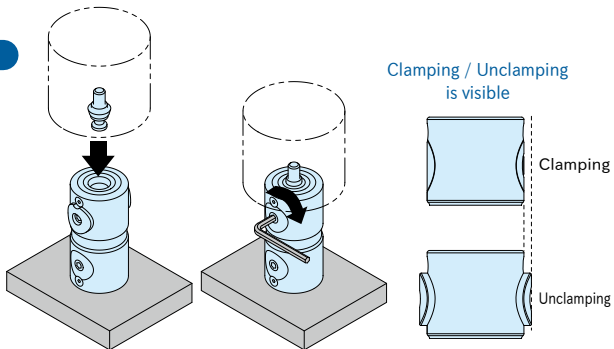

Clamping Modules

1 Flanged



Part Number	Diameter (mm)	Height (mm)	Clamping Force (kN)
CP150-06025	30	25	5
CP150-08040	40	40	8
CP150-12063	60	63	15
CP150-16080	80	80	25

2 Double



Part Number	Diameter (mm)	Height (mm)	Clamping Force (kN)
CP151-06050	30	50	5
CP151-08080	40	80	8
CP151-12125	60	125	15
CP151-16160	80	160	25

3 Single



Part Number	Diameter (mm)	Height (mm)	Clamping Force (kN)
CP152-06032	30	32	5
CP152-08050	40	50	8
CP152-12080	60	80	15
CP152-16100	80	100	25

Tapered Clamping Screws

4 Round



Part Number	Thread Size	Workpiece Locating Repeatability
CP155-06001L	M 6	5μm
CP155-08061L	M 6	
CP155-08001L	M 8	
CP155-12081L	M 8	
CP155-12001L	M12	
CP155-16121L	M12	
CP155-16001L	M16	

5 Diamond



Part Number	Thread Size	Workpiece Locating Repeatability
CP155-08061D	M 6	5μm (Should be used with round type.)
CP155-08001D	M 8	
CP155-12081D	M 8	
CP155-12001D	M12	
CP155-16121D	M12	
CP155-16001D	M16	

Clamping Screws

6



Part Number	Thread Size
CP156-06001	M 6
CP156-08061	M 6
CP156-08001	M 8
CP156-12081	M 8
CP156-12001	M12
CP156-16121	M12
CP156-16001	M16

Tapered Bushings

7 Accurate



Part Number	Clamping Module Locating Repeatability
CP157-06001L	5μm
CP157-08001L	
CP157-12001L	
CP157-16001L	

8 Standard



Part Number	Clamping Module Locating Repeatability
CP157-06001S	0.1mm
CP157-08001S	
CP157-12001S	
CP157-16001S	

Double Tapered Clamping Pins

9



Part Number	Clamping Module Locating Repeatability
CP158-08001	0.2mm
CP158-12001	
CP158-16001	

Locating Bushings

10



Part Number	Diameter (mm)	Clamping Module Locating Repeatability
CP159-06001	8h6	0.04mm
CP159-08001	12h6	
CP159-12001	18h6	
CP159-16001	22h6	

Allowable Cutting Force & Workpiece Weight of CLAMPING MODULES

Ensure the cutting force and the workpiece weight are within the allowable level. The values below are only the strength of the body of clamping modules. The rigidity of the whole fixtures and the workpiece are not considered. Use the values as a guide for setting appropriate machining conditions.

1 Module

Note: Prepare a locator when the workpiece gets big rotating force.

Horizontal

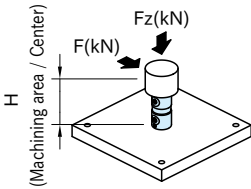

Vertical

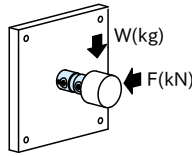

Part Number	Allowable Cutting Force		Allowable Workpiece Weight W(kg)
	F(kN)	Fz(kN)	
CP150-06025	50/H	1.5	50×100/H
CP151-06050	25/H		25×100/H
CP152-06032	25/H	2.5	25×100/H
CP150-08040	120/H		120×100/H
CP151-08080	70/H		70×100/H
CP152-08050	70/H	7.5	70×100/H
CP150-12063	250/H		250×100/H
CP151-12125	150/H	15	150×100/H
CP152-12080	150/H		150×100/H
CP150-16080	500/H	300×100/H	500×100/H
CP151-16160	300/H		300×100/H
CP152-16100	300/H		300×100/H

2 Modules

Horizontal

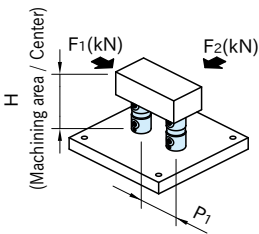

Vertical

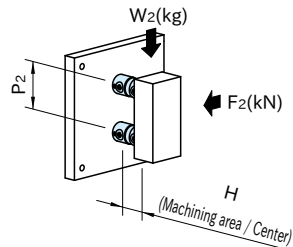
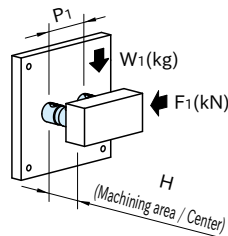

Part Number	Allowable Cutting Force			Allowable Workpiece Weight		
	F ₁ (kN)	F ₂ (kN)	Max(kN)	W ₁ (kg)	W ₂ (kg)	Max(kg)
CP150-06025	(0.10P ₁ + 180)/H	100/H	1.8	100×100/H	(0.10P ₂ + 180)×100/H	180
CP151-06050	(0.05P ₁ + 90)/H	50/H		50×100/H	(0.05P ₂ + 90)×100/H	
CP152-06032	(0.05P ₁ + 90)/H	50/H	3.2	50×100/H	(0.05P ₂ + 90)×100/H	320
CP150-08040	(0.24P ₁ + 432)/H	240/H		240×100/H	(0.24P ₂ + 432)×100/H	
CP151-08080	(0.14P ₁ + 252)/H	140/H		140×100/H	(0.14P ₂ + 252)×100/H	
CP152-08050	(0.14P ₁ + 252)/H	140/H	6	140×100/H	(0.14P ₂ + 252)×100/H	600
CP150-12063	(0.50P ₁ + 900)/H	500/H		500×100/H	(0.50P ₂ + 900)×100/H	
CP151-12125	(0.30P ₁ + 540)/H	300/H	10	300×100/H	(0.30P ₂ + 540)×100/H	1000
CP152-12080	(0.30P ₁ + 540)/H	300/H		300×100/H	(0.30P ₂ + 540)×100/H	
CP150-16080	(1.00P ₁ +1800)/H	1000/H	600×100/H	1000×100/H	(1.00P ₂ +1800)×100/H	
CP151-16160	(0.60P ₁ +1080)/H	600/H		600×100/H	(0.60P ₂ +1080)×100/H	
CP152-16100	(0.60P ₁ +1080)/H	600/H		600×100/H	(0.60P ₂ +1080)×100/H	

4 Modules

Horizontal

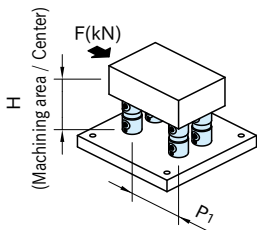

Vertical

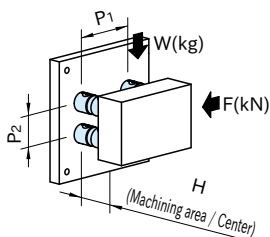

Part Number	Allowable Cutting Force		Allowable Workpiece Weight	
	F(kN)	Max(kN)	W(kg)	Max(kg)
CP150-06025	$2 \times (0.10P_1 + 180) / H$	3.6	$2 \times (0.10P_2 + 180) \times 100 / H$	360
CP151-06050	$2 \times (0.05P_1 + 90) / H$		$2 \times (0.05P_2 + 90) \times 100 / H$	
CP152-06032	$2 \times (0.05P_1 + 90) / H$		$2 \times (0.05P_2 + 90) \times 100 / H$	
CP150-08040	$2 \times (0.24P_1 + 432) / H$	6.4	$2 \times (0.24P_2 + 432) \times 100 / H$	640
CP151-08080	$2 \times (0.14P_1 + 252) / H$		$2 \times (0.14P_2 + 252) \times 100 / H$	
CP152-08050	$2 \times (0.14P_1 + 252) / H$		$2 \times (0.14P_2 + 252) \times 100 / H$	
CP150-12063	$2 \times (0.50P_1 + 900) / H$	12	$2 \times (0.50P_2 + 900) \times 100 / H$	1200
CP151-12125	$2 \times (0.30P_1 + 540) / H$		$2 \times (0.30P_2 + 540) \times 100 / H$	
CP152-12080	$2 \times (0.30P_1 + 540) / H$		$2 \times (0.30P_2 + 540) \times 100 / H$	
CP150-16080	$2 \times (1.00P_1 + 1800) / H$	20	$2 \times (1.00P_2 + 1800) \times 100 / H$	2000
CP151-16160	$2 \times (0.60P_1 + 1080) / H$		$2 \times (0.60P_2 + 1080) \times 100 / H$	
CP152-16100	$2 \times (0.60P_1 + 1080) / H$		$2 \times (0.60P_2 + 1080) \times 100 / H$	

Calculation Example

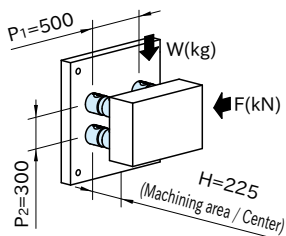

- Vertical mounting
- 4 pcs of CP151-12125 (height 125mm)
- Pitch:
 $P_1 = 500\text{mm}$
 $P_2 = 300\text{mm}$
- Workpiece center: $H = 225\text{mm}$
- F direction cutting force: 3kN
- Workpiece weight: 375kg

Related Product

Hook type for horizontal machining center is available.

<Allowable Cutting Force F>

$$F = 2 \times (0.3 \times P_1 + 540) / H$$

$$= 2 \times (0.3 \times 500 + 540) / 225$$

$$= 6.13\text{kN}$$

*) Cutting force 3kN is within allowable value (6.13kN).

<Allowable Workpiece Weight W>

$$W = 2 \times (0.3 \times P_2 + 540) \times 100 / H$$

$$= 2 \times (0.3 \times 300 + 540) \times 100 / 225$$

$$= 560\text{kg}$$

*) Workpiece weight 375kg is within allowable value (560kg).

CP150

CLAMPING MODULES (Flanged)



CP150 -06025



CP150 -08040, 12063, 16080

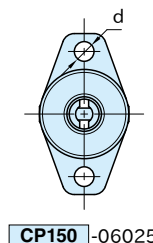
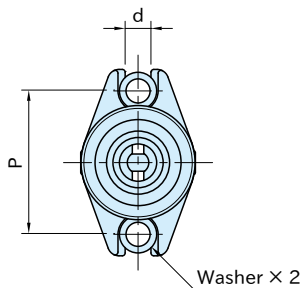

CP150 -06025

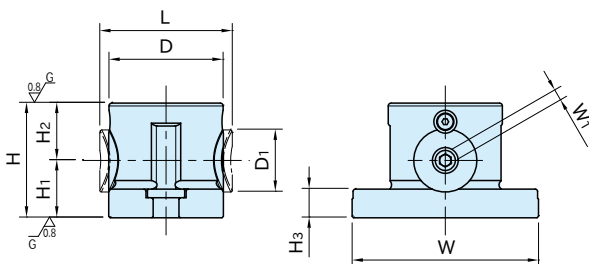

Body	Clamping Nut	Locking Screw
SCM440 steel Induction hardened Black oxide finished Precision ground	SCM440 steel Quenched and tempered Black oxide finished	SCM435 steel Quenched and tempered Black oxide finished

Part Number	D	H (±0.01)	D ₁	L	H ₁	H ₂	W	H ₃	d	P	W ₁
CP150-06025	30	25	15	34.5	12.5	12.5	54	7	6.6	42	3
CP150-08040	40	40	22	46	20	20	65	10	9	50	4
CP150-12063	60	63	32	69	33	30	95	15	13	75	6
CP150-16080	80	80	44	91	40	40	130	20	17	100	8

Part Number	Clamping Force (kN)	Allowable Screw Torque (N·m)	Weight (kg)
CP150-06025	5	4	0.1
CP150-08040	8	8	0.3
CP150-12063	15	22	1.4
CP150-16080	25	50	3.3

Supplied With

CP150-08040, 12063, 16080 : 2 pcs. of flat washer

Technical Information

Allowable Cutting Force & Workpiece Weight of CLAMPING MODULES

Related Product

- CP155-L Tapered Clamping Screws (Round)
- CP155-D Tapered Clamping Screws (Diamond)
- CP156 Clamping Screws
- CP157 Tapered Bushings

How To Use

- Use **CP157-L** Tapered Bushing (Accurate) for precise locating.
- Use **CP157-S** Tapered Bushing (Standard) for rough locating.

Mounting-Hole Dimension

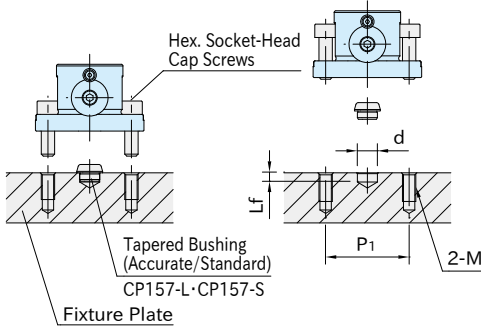

Part Number	d (H7)	Lf	M	P ₁
CP150-06025	8	5.5	M 6×1	42
CP150-08040	12	5.5	M 8×1.25	50
CP150-12063	18	6.5	M12×1.75	75
CP150-16080	22	8	M16×2	100

Note: The tolerance of dimension "d" for Tapered Bushing (Standard) should be $^{+0.1}_0$.

Spacing Tolerance

Spacing tolerance for CP157-L Tapered Bushings (Accurate) should be ± 0.02 .

*) Spacing tolerance for CP157-S Tapered Bushings (Standard) should be ± 0.1 .

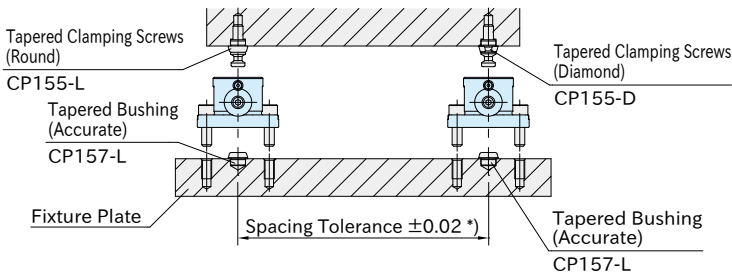

Tightening Order

Tighten the locking screws in order of 1(Round Tapered Clamping Screw)→2(Diamond Tapered Clamping Screw)→3(Clamping Screw)→4(Clamping Screw).

Note: For **CP150-06025**, use 2 pieces of Round Tapered Clamping Screw.

Tighten these 2 screws in the same order to maintain the locating repeatability.

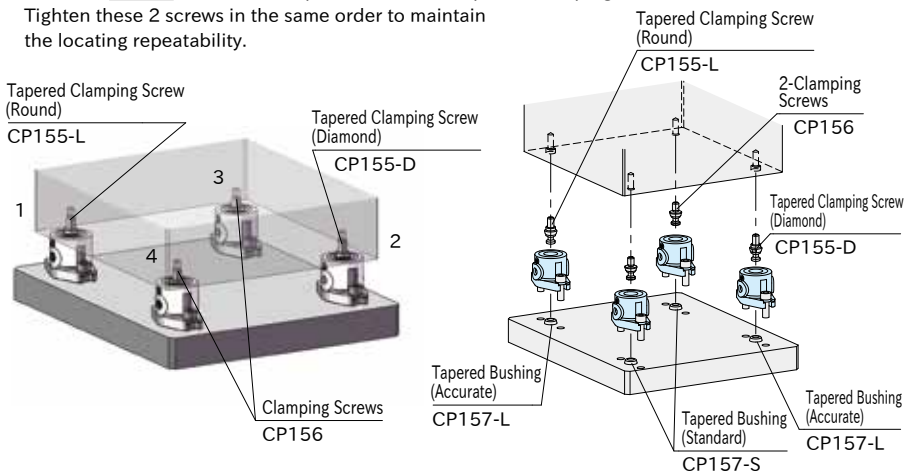

CP151

CLAMPING MODULES (Double)



CP151-06050



CP151-08080, 12125, 16160

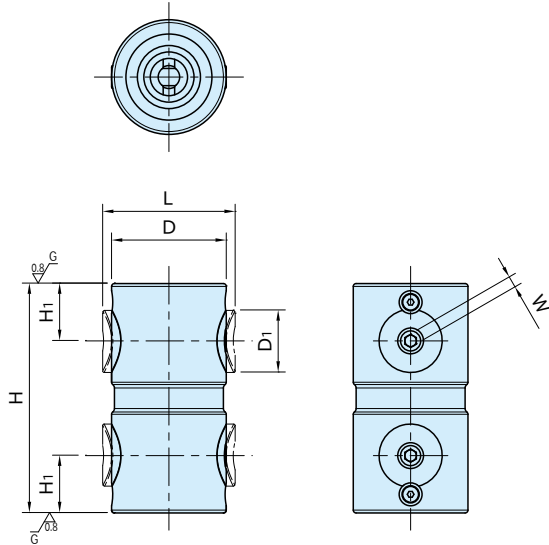

Body	Clamping Nut	Locking Screw
SCM440 steel Induction hardened Black oxide finished Precision ground	SCM440 steel Quenched and tempered Black oxide finished	SCM435 steel Quenched and tempered Black oxide finished

Part Number	D	H (±0.01)	D ₁	L	H ₁	W	Clamping Force (kN)	Allowable Screw Torque (N·m)	Weight (kg)
CP151-06050	30	50	15	34.5	12.5	3	5	4	0.2
CP151-08080	40	80	22	46	20	4	8	8	0.7
CP151-12125	60	125	32	69	30	6	15	22	2.6
CP151-16160	80	160	44	91	40	8	25	50	5.8

Related Product

- CP150 Clamping Modules (Flanged)
- CP152 Clamping Modules (Single)
- CP155-L Tapered Clamping Screws (Round)
- CP155-D Tapered Clamping Screws (Diamond)
- CP156 Clamping Screws

Technical Information

Allowable Cutting Force & Workpiece Weight of CLAMPING MODULES

How To Use

- Use **CP155-L** Tapered Clamping Screw (Round) for precise locating.
- Use **CP156** Clamping Screw just for fixing.

Mounting-Hole Dimension

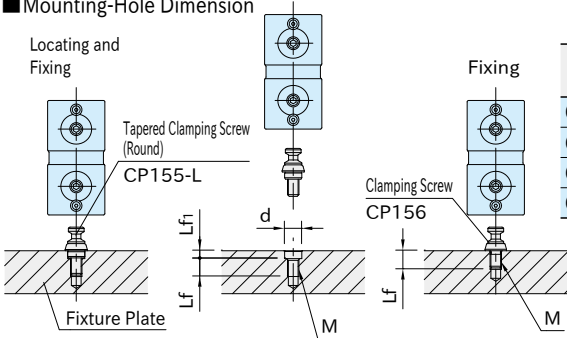

Part Number	d (H7)	Lf	Lf ₁	M
CP151-06050	8	9	5.5	M 6×1
CP151-08080	12	13	5.5	M 8×1.25
CP151-12125	18	19	6.5	M12×1.75
CP151-16160	22	23	8	M16×2

Note: Only tapped hole is required for CP156 Clamping Screw.

Spacing Tolerance

Spacing tolerance for CP155-L Tapered Clamping Screws (Accurate) should be ± 0.02 .

*) Spacing tolerance for CP156 Clamping Screws should be ± 0.2 .

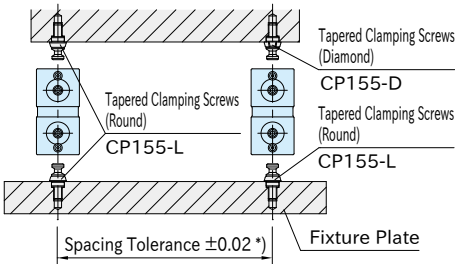

Coupling with Other Clamping Modules

Can be coupled with each Clamping Module. (Locating Repeatability is 0.2)

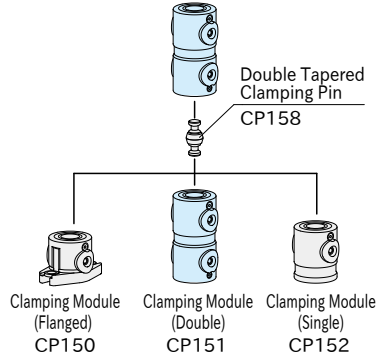

Tightening Order

Tighten the locking screws in order of 1(Round Tapered Clamping Screw)→2(Diamond Tapered Clamping Screw)→3(Clamping Screw)→4(Clamping Screw).

Note: For **CP151**-06050, use 2 pieces of Round Tapered Clamping Screw.

Tighten these 2 screws in the same order to maintain the locating repeatability.

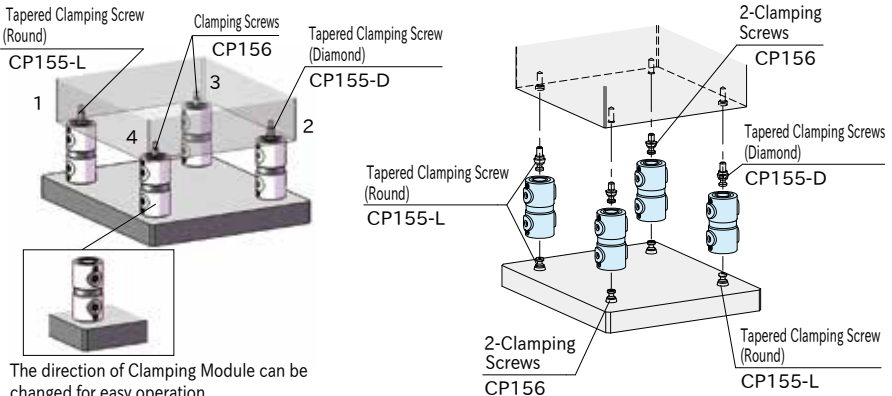

The direction of Clamping Module can be changed for easy operation.

CP152

CLAMPING MODULES (Single)



CP152 -06032

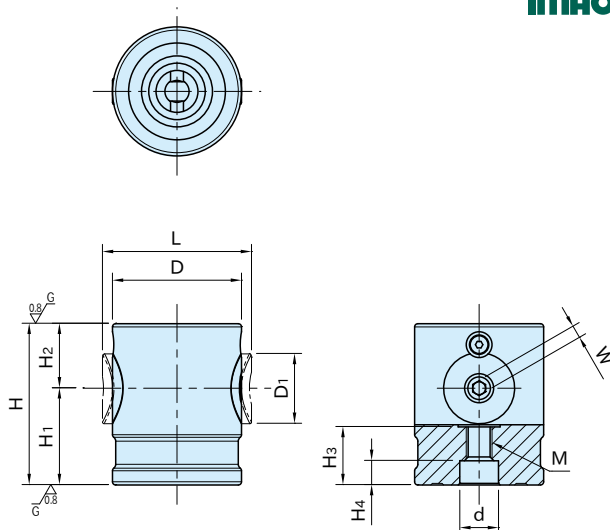

CP152 -08050, 12080, 16100

Body	Clamping Nut	Locking Screw
SCM440 steel Induction hardened Black oxide finished Precision ground	SCM440 steel Quenched and tempered Black oxide finished	SCM435 steel Quenched and tempered Black oxide finished

Part Number	D	H (±0.01)	D ₁	L	H ₁	H ₂	H ₃	d (H7)	H ₄	M	W
CP152-06032	30	32	15	34.5	19.5	12.5	11.5	8	5	M 6X1	3
CP152-08050	40	50	22	46	30	20	18	12	7.5	M 8X1.25	4
CP152-12080	60	80	32	69	50	30	25	18	10.5	M12X1.75	6
CP152-16100	80	100	44	91	60	40	31	22	12.5	M16X2	8

Part Number	Clamping Force (kN)	Allowable Screw Torque (N·m)	Weight (kg)
CP152-06032	5	4	0.2
CP152-08050	8	8	0.5
CP152-12080	15	22	1.6
CP152-16100	25	50	3.8

Related Product

- CP150 Clamping Modules (Flanged)
- CP151 Clamping Modules (Double)
- CP155-L Tapered Clamping Screws (Round)
- CP155-D Tapered Clamping Screws (Diamond)
- CP156 Clamping Screws
- CP159 Locating Bushings

Technical Information

Allowable Cutting Force & Workpiece Weight of
CLAMPING MODULES

How To Use

- Use [CP159] Locating Bushing for precise locating.
- Use only hex. socket-head cap screw just for fixing.

Mounting-Hole Dimension

Locating and Fixing

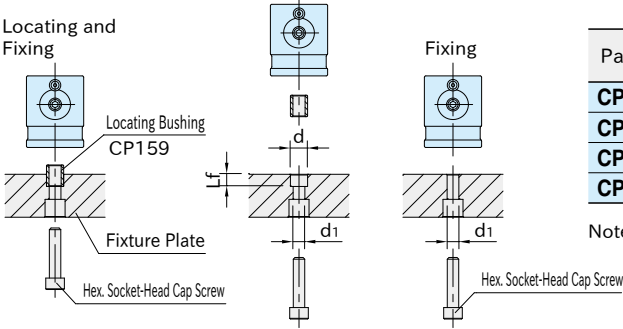

Part Number	d (H7)	Lf	d1 (+0.2 / 0)
CP152-06032	8	6.5	6
CP152-08050	12	8.5	8
CP152-12080	18	12.5	12
CP152-16100	22	16.5	16

Note: Only c'bored hole is required just for fixing.

Spacing Tolerance

Spacing tolerance for CP159 Locating Bushings should be ± 0.02 .

*) Spacing tolerance for hex. socket-head cap screw should be ± 0.1 .

Coupling with Other Clamping Modules

Can be coupled with each Clamping Module. (Locating Repeatability is $5 \mu\text{m}$)

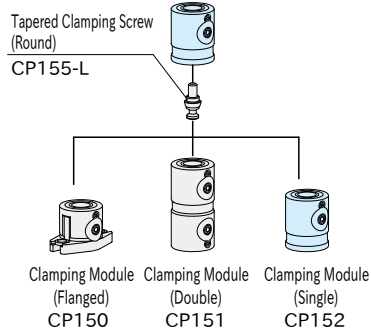
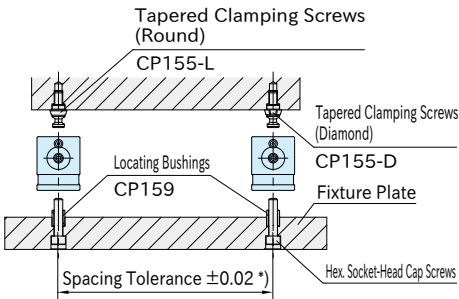

Tightening Order

Tighten the locking screws in order of 1 (Round Tapered Clamping Screw) → 2 (Diamond Tapered Clamping Screw) → 3 (Clamping Screw) → 4 (Clamping Screw).

Note: For [CP152]-06032, use 2 pieces of Round Tapered Clamping Screw.

Tighten these 2 screws in the same order to maintain the locating repeatability.

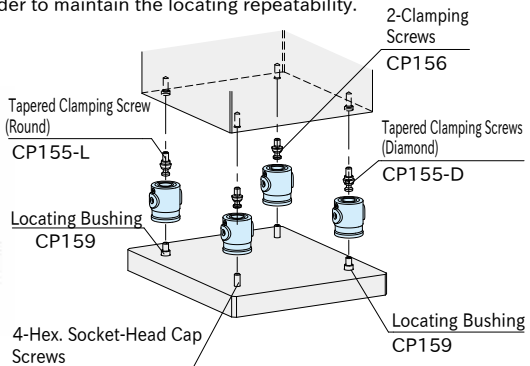
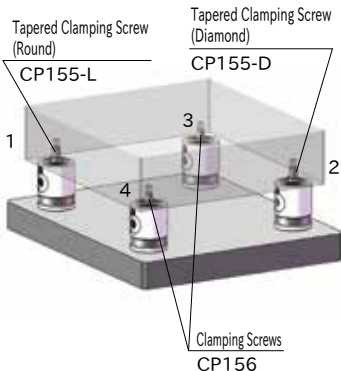

CP155-L

TAPERED CLAMPING SCREWS (Round)

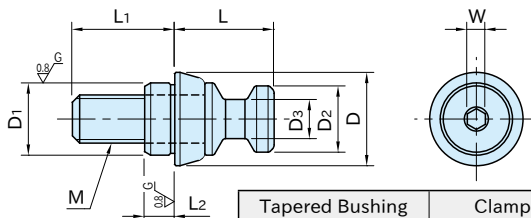

Tapered Bushing	Clamping Screw
S45C steel Black oxide finished Precision ground	SCM435 steel Quenched and tempered Black oxide finished

Part Number	M	D ₁ (g6)	L ₂	L ₁	D	L	D ₂	D ₃	W	Weight (g)	CLAMPING MODULES
CP155-06001L	M 6X1	8	5	13	11.5	10	8	4.8	2.5	6	CP150-06025, CP151-06050 CP152-06032
CP155-08061L	M 6X1	10	5	17	15.5	16.5	11	6.5	3	17	CP150-08040, CP151-08080 CP152-08050
CP155-08001L	M 8X1.25	12	5	17	24.5	25	16	9.5	5	20	CP150-12063, CP151-12125 CP152-12080
CP155-12081L	M 8X1.25	12	5	17	24.5	25	16	9.5	5	52	CP150-12063, CP151-12125 CP152-12080
CP155-12001L	M12X1.75	18	6	24	31.5	33	21	13	6	70	CP150-16080, CP151-16160 CP152-12080
CP155-16121L	M12X1.75	18	6	24	31.5	33	21	13	6	125	CP150-16080, CP151-16160 CP152-16100
CP155-16001L	M16X2	22	7.5	30	31.5	33	21	13	6	150	CP152-16100

CP155-D

TAPERED CLAMPING SCREWS (Diamond)

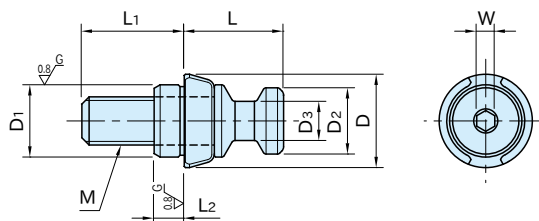

Tapered Bushing	Clamping Screw
S45C steel Black oxide finished Precision ground	SCM435 steel Quenched and tempered Black oxide finished

Part Number	M	D ₁ (g6)	L ₂	L ₁	D	L	D ₂	D ₃	W	Weight (g)	CLAMPING MODULES
CP155-08061D	M 6X1	10	5	17	15.5	16.5	11	6.5	3	17	CP150-08040, CP151-08080 CP152-08050
CP155-08001D	M 8X1.25	12	5	17	24.5	25	16	9.5	5	20	CP150-12063, CP151-12125 CP152-12080
CP155-12081D	M 8X1.25	12	5	17	24.5	25	16	9.5	5	51	CP150-12063, CP151-12125 CP152-12080
CP155-12001D	M12X1.75	18	6	24	31.5	33	21	13	6	70	CP150-16080, CP151-16160 CP152-12080
CP155-16121D	M12X1.75	18	6	24	31.5	33	21	13	6	123	CP150-16080, CP151-16160 CP152-16100
CP155-16001D	M16X2	22	7.5	30	31.5	33	21	13	6	150	CP152-16100

How To Use

Round Type

- Can be used for locating **CP151** Clamping Module (Double).
- Can be used for locating a workpiece with diamond type.

Diamond Type

- Can be used for locating a workpiece with round type.
- Fix the tapered bushing of diamond type after deciding the direction.

Note: For **CP150**-06025, **CP151**-06050 or **CP152**-06032, use 2 pieces of Round Type.

Spacing Tolerance

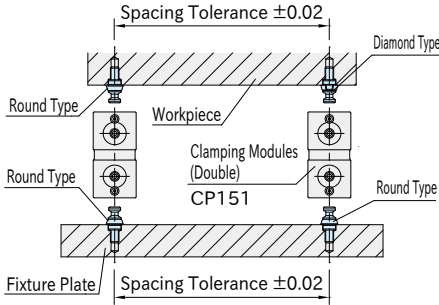

Mounting-Hole Dimension

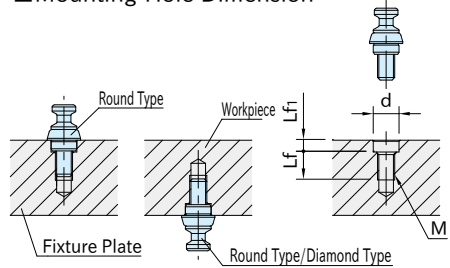

Size	d (H7)	Lf	Lf1	M
CP155-06001	8	9	5.5	M 6×1
CP155-08061	10	13	5.5	M 6×1
CP155-08001	12			M 8×1.25
CP155-12081	12	13	5.5	M 8×1.25
CP155-12001	18	19	6.5	M12×1.75
CP155-16121	18	19	6.5	M12×1.75
CP155-16001	22	23	8	M16×2

Application Example

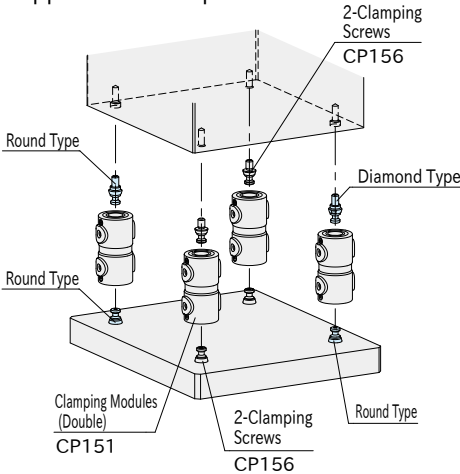

Coupling of Clamping Module (Single)

Round type can be used as a coupling for Clamping Module (Single).

⟨Locating Repeatability is 5 μm⟩

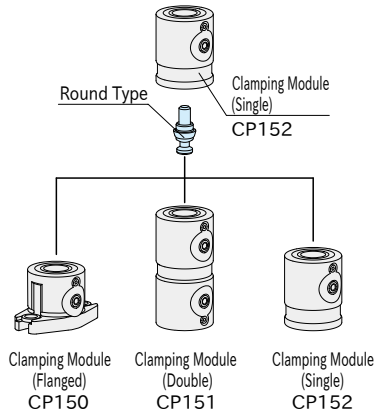

Related Product

- **CP150** Clamping Modules (Flanged)
- **CP151** Clamping Modules (Double)
- **CP152** Clamping Modules (Single)
- **CP156** Clamping Screws

CP156

CLAMPING SCREWS

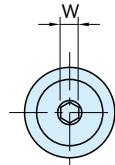
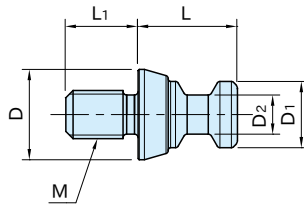

Body

SCM435 steel
Quenched and tempered
Black oxide finished

Part Number	M	L ₁	D	L	D ₁	D ₂	W	Weight (g)	CLAMPING MODULES
CP156-06001	M 6×1	8	11	10	8	4.8	2.5	5	CP150-06025, CP151-06050 CP152-06032
CP156-08061	M 6×1	9	15	16.5	11	6.5	3	13	CP150-08040, CP151-08080 CP152-08050
CP156-08001	M 8×1.25	12						16	
CP156-12081	M 8×1.25	12	24	25	16	9.5	5	46	CP150-12063, CP151-12125 CP152-12080
CP156-12001	M12×1.75	18						57	
CP156-16121	M12×1.75	18	31	33	21	13	6	108	CP150-16080, CP151-16160 CP152-16100
CP156-16001	M16×2	22						125	

How To Use

- Can be used for mounting [CP151](#) Clamping Module (Double) on the fixture plate.
- Can be installed on the workpiece.
- No locating function.
- Spacing tolerance of the tapped holes should be ± 0.2 .

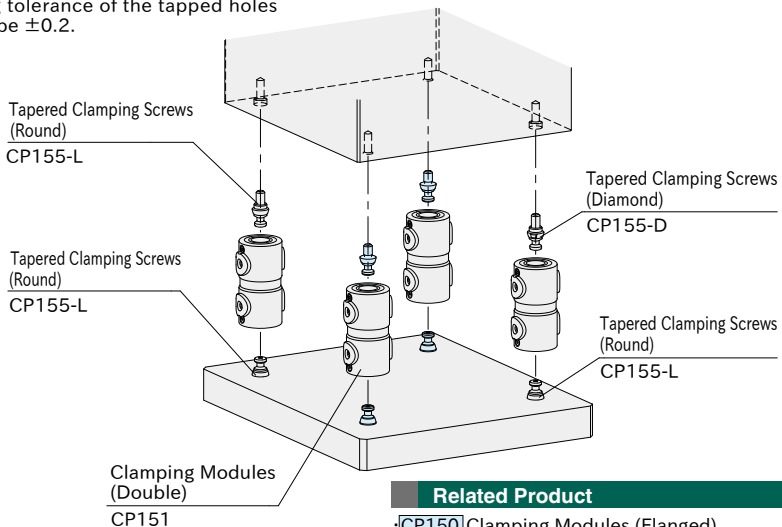

Related Product

- [CP150](#) Clamping Modules (Flanged)
- [CP151](#) Clamping Modules (Double)
- [CP152](#) Clamping Modules (Single)
- [CP155-L](#) Tapered Clamping Screws (Round)
- [CP155-D](#) Tapered Clamping Screws (Diamond)

Note

Contact us for customization.

CP157

TAPERED BUSHINGS



CP157-L
(Accurate)



CP157-S
(Standard)

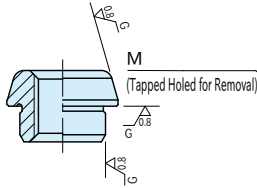

CP157-L
(Accurate)

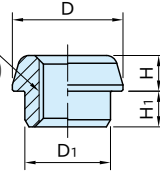

CP157-S
(Standard)

Body
S45C steel
Black oxide finished
Precision ground (only for Accurate type)

Accurate		Standard		D	H	H ₁	M	Weight (g)	CLAMPING MODULES
Part Number	D ₁ (g6)	Part Number	D ₁ (-0.02 / -0.05)						
CP157-06001L	8	CP157-06001S	8	11.5	4	5	M 6×1	4	CP150-06025
CP157-08001L	12	CP157-08001S	12	15.5	5	5	M 8×1.25	8	CP150-08040, CP160-08040*
CP157-12001L	18	CP157-12001S	18	24.5	8	6	M12×1.75	27	CP150-12063, CP160-12063*
CP157-16001L	22	CP157-16001S	22	31.5	10	7.5	M16×2	51	CP150-16080, CP160-16080*

How To Use

- Can be used for mounting **CP150** Clamping Module (Flanged) on the fixture plate.
- Use Accurate Type for precise locating of a clamping module.
- Use Standard Type for rough locating of a clamping module.

Mounting-Hole Dimension

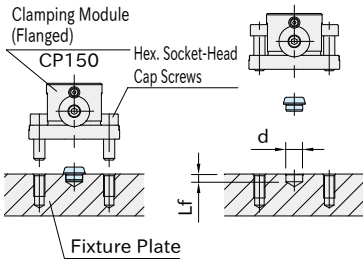

Size	d (H7)	Lf
06001	8	5.5
08001	12	5.5
12001	18	6.5
16001	22	8

Note: The tolerance of dimension "d" for Standard Type should be $^{+0.1}_{0}$.

Related Product

- **CP150** Clamping Modules (Flanged)
- **CP155-L** Tapered Clamping Screws (Round)
- **CP155-D** Tapered Clamping Screws (Diamond)
- **CP156** Clamping Screws
- **CP160** Clamping Modules (Hook)

Spacing Tolerance

Spacing tolerance for Accurate Type should be ± 0.02 .
*) Spacing tolerance for Standard Type should be ± 0.1 .

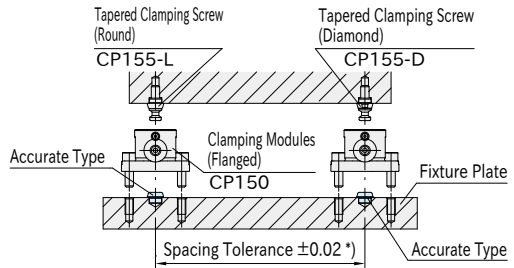

Application Example

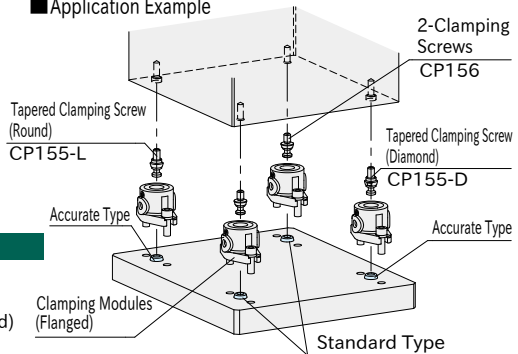

CP158

DOUBLE TAPERED CLAMPING PINS

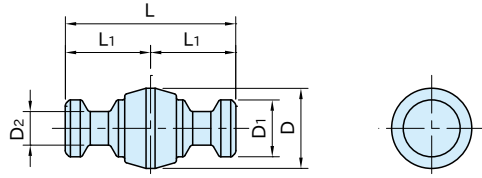

Body
SCM435 steel Quenched and tempered Black oxide finished

Part Number	D	L	D ₁	D ₂	L ₁	Weight (g)	CLAMPING MODULES
							CP158-08001
CP158-12001	24.5	50	16	9.5	25	85	CP150-12063, CP151-12125, CP152-12080
CP158-16001	31.5	66	21	13	33	190	CP150-16080, CP151-16160, CP152-16100

How To Use

Can be used as a coupling for CP151 Clamping Module (Double).
 <Locating Repeatability is 0.2>

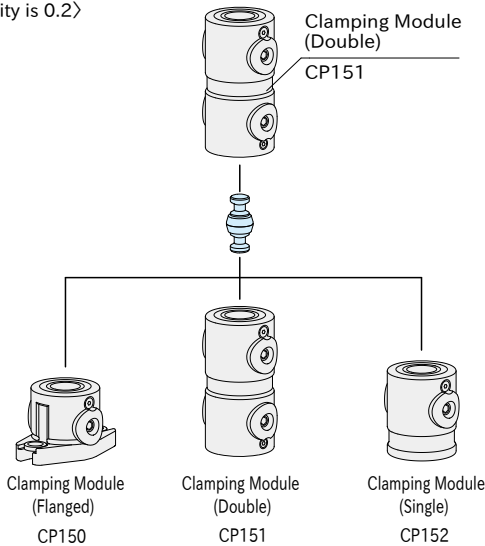

CP159

LOCATING BUSHINGS

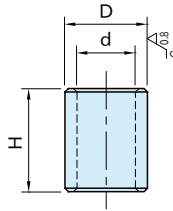

Body
SK95 steel
Quenched and tempered
Black oxide finished
Precision ground

Part Number	d	D (h6)	H	Weight (g)	CLAMPING MODULES
CP159-06001	6	8	11	2	CP152-06032
CP159-08001	8.5	12	15	7	CP152-08050
CP159-12001	12.5	18	22	22	CP152-12080
CP159-16001	16.5	22	28	35	CP152-16100

How To Use

Can be used for locating **CP152** Clamping Module (Single) on the fixture plate.

Mounting-Hole Dimension

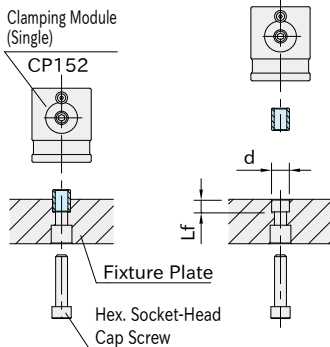

Part Number	d (H7)	Lf
CP159-06001	8	6.5
CP159-08001	12	8.5
CP159-12001	18	12.5
CP159-16001	22	16.5

Related Product

- **CP152** Clamping Modules (Single)
- **CP155-L** Tapered Clamping Screws (Round)
- **CP155-D** Tapered Clamping Screws (Diamond)
- **CP156** Clamping Screws

Spacing Tolerance

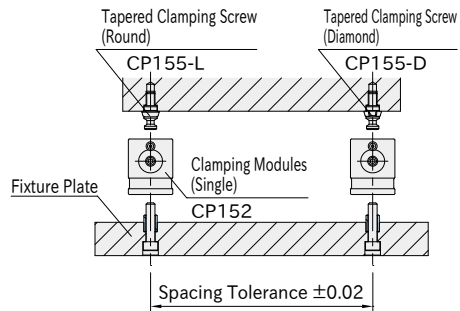

Application Example

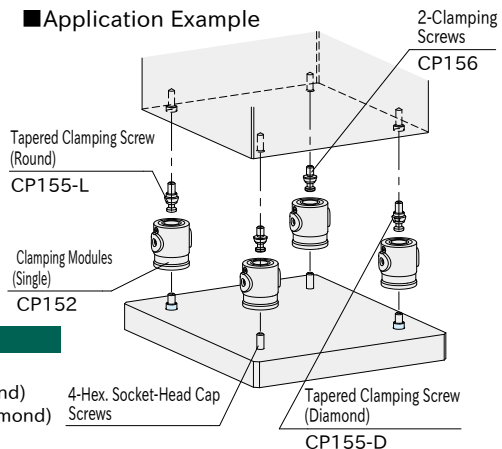



MODULAR PULL CLAMPING SYSTEM HOOK TYPE

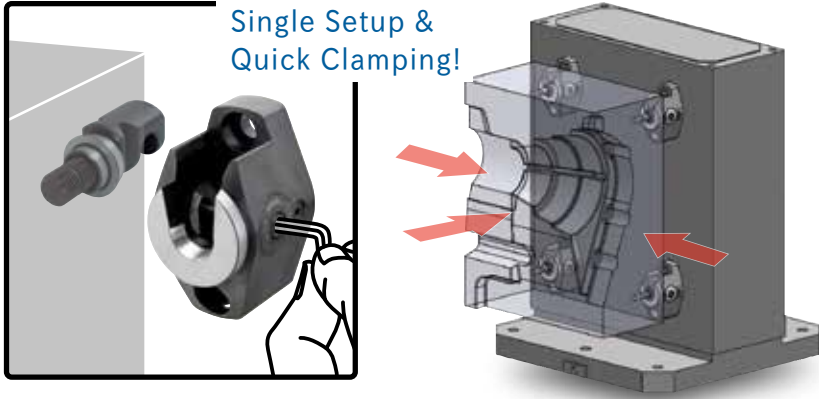

For Horizontal Machining Center MODULAR PULL CLAMPING SYSTEM HOOK TYPE

Hook-shaped clamping screws enable to hang the workpiece before clamping!
Quick and safety workpiece setup in vertical workholding.

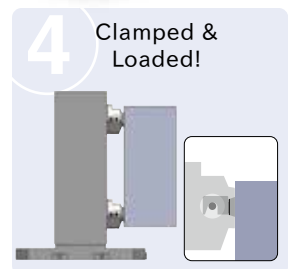
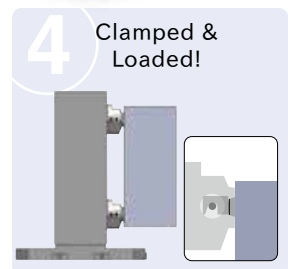
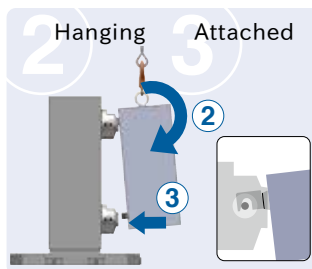
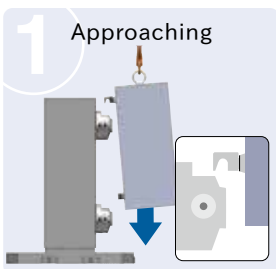
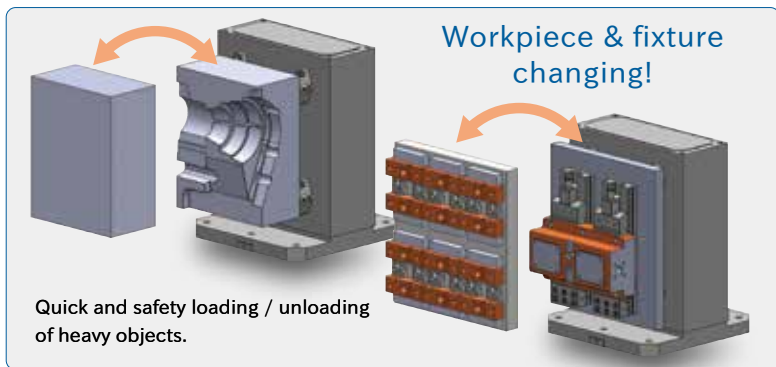

How To Use Modular Pull Clamping System Hook Type

Assembly Chart

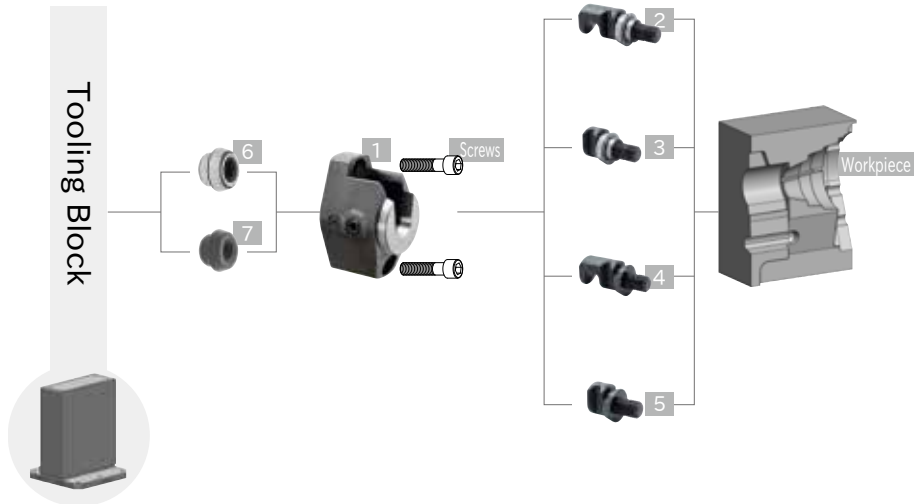

Clamping Modules

1 Hook



Part Number		Height (mm)	Clamping Force (kN)
CP160-08040R	CP160-08040L	40	8
CP160-12063R	CP160-12063L	63	15
CP160-16080R	CP160-16080L	80	25

Tapered Clamping Screws

2 With Hook



Part Number	Thread Size	Workpiece Locating Repeatability
CP165-08001LH	M 8	5 μ m
CP165-12001LH	M12	
CP165-16001LH	M16	

3 Without Hook



Part Number	Thread Size	Workpiece Locating Repeatability
CP165-08001L	M 8	5 μ m
CP165-12001L	M12	
CP165-16001L	M16	

Clamping Screws

4 With Hook



Part Number	Thread Size
CP166-08001H	M 8
CP166-12001H	M12
CP166-16001H	M16

5 Without Hook



Part Number	Thread Size
CP166-08001	M 8
CP166-12001	M12
CP166-16001	M16

Tapered Bushings

6 Accurate



Part Number	Clamping Module Locating Repeatability
CP157-08001L	5 μ m
CP157-12001L	
CP157-16001L	

7 Standard



Part Number	Clamping Module Locating Repeatability
CP157-08001S	0.1mm
CP157-12001S	
CP157-16001S	

Allowable Cutting Force & Workpiece Weight of CLAMPING MODULES (Hook)

Ensure the cutting force and the workpiece weight are within the allowable level.
 The values below are only the strength of the body of clamping modules.
 The rigidity of the whole fixtures and the workpiece are not considered.
 Use the values as a guide for setting appropriate machining conditions.

2 Modules

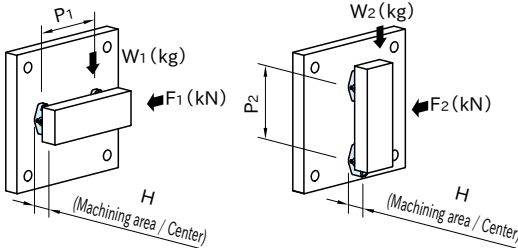

Note

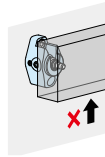

Heavy cutting force in the open direction may cause workpiece move.

Size	Allowable Cutting Force			Allowable Workpiece Weight		
	F ₁ (kN)	F ₂ (kN)	Max (kN)	W ₁ (kg)	W ₂ (kg)	Max (kg)
CP160-08040	$(0.24P_1 + 432)/H$	240/H	3.2	$240 \times 100/H$	$(0.24P_2 + 432) \times 100/H$	320
CP160-12063	$(0.50P_1 + 900)/H$	500/H	6	$500 \times 100/H$	$(0.50P_2 + 900) \times 100/H$	600
CP160-16080	$(1.00P_1 + 1800)/H$	1000/H	10	$1000 \times 100/H$	$(1.00P_2 + 1800) \times 100/H$	1000

4 Modules

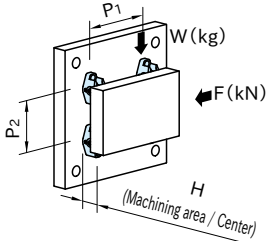

Caution

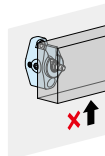

Heavy cutting force in the open direction may cause workpiece move.

Size	Allowable Cutting Force		Allowable Workpiece Weight	
	F (kN)	Max (kN)	W (kg)	Max (kg)
CP160-08040	$2 \times (0.24P_1 + 432)/H$	6.4	$2 \times (0.24P_2 + 432) \times 100/H$	640
CP160-12063	$2 \times (0.50P_1 + 900)/H$	12	$2 \times (0.50P_2 + 900) \times 100/H$	1200
CP160-16080	$2 \times (1.00P_1 + 1800)/H$	20	$2 \times (1.00P_2 + 1800) \times 100/H$	2000

Calculation Example

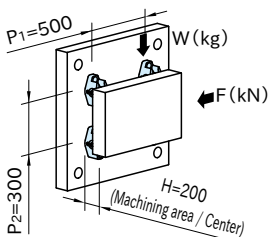

- 4 pcs of CP160-12063R/L (height 63mm)
- Pitch:
 $P_1 = 500\text{mm}$
 $P_2 = 300\text{mm}$
- Workpiece center: $H = 200\text{mm}$
- F direction cutting force: 5kN
- Workpiece weight: 600kg

$$\begin{aligned} <\text{Allowable Cutting Force } F> \\ F &= 2 \times (0.5 \times P_1 + 900) / H \\ &= 2 \times (0.5 \times 500 + 900) / 200 \\ &= 11.5\text{kN} \end{aligned}$$

*) Cutting force 5kN is within allowable value (11.5kN).

$$\begin{aligned} <\text{Allowable Workpiece Weight } W> \\ W &= 2 \times (0.5 \times P_2 + 900) \times 100 / H \\ &= 2 \times (0.5 \times 300 + 900) \times 100 / 200 \\ &= 1050\text{kg} \end{aligned}$$

*) Workpiece weight 600kg is within allowable value (1050kg).

CP160

CLAMPING MODULES (Hook)

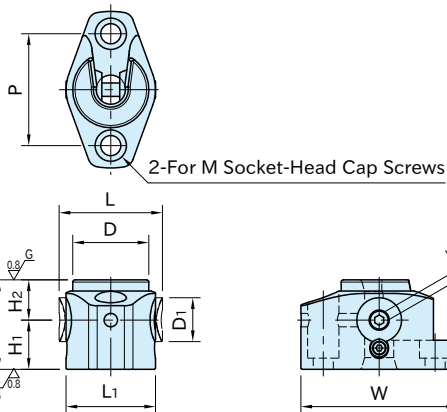

Note: The drawing shows CP160-R. The hex. socket for locking screw (W_1) is on the other side in CP160-L.

Body	Clamping Nut	Locking Screw
SCM440 steel Induction hardened Black oxide finished Precision ground	SCM440 steel Quenched and tempered Black oxide finished	SCM435 steel Quenched and tempered Black oxide finished

Part Number	D	H (± 0.01)	D ₁	L	H ₁	H ₂	W	L ₁	H ₃
CP160-08040R	34	40	20	46	22	18	70	40	13
CP160-08040L									
CP160-12063R	52	63	30	69	35	28	100	60	20
CP160-12063L									
CP160-16080R	70	80	40	93	44	36	140	80	26
CP160-16080L									

Part Number	M	P	H ₄	W ₁	Clamping Force (kN)	Allowable Screw Torque (N·m)	Weight (kg)
CP160-08040R	M 8	50	5	4	8	8	0.4
CP160-08040L							
CP160-12063R	M12	75	8	6	15	22	1.4
CP160-12063L							
CP160-16080R	M16	100	10	8	25	50	3.2
CP160-16080L							

Technical Information

Allowable Cutting Force & Workpiece Weight of CLAMPING MODULES (Hook)

Related Product

- [CP157](#) Tapered Bushings
- [CP165-LH](#) Tapered Clamping Screws (Hook)
- [CP165-L](#) Tapered Clamping Screws
- [CP166-H](#) Clamping Screws (Hook)
- [CP166](#) Clamping Screws

How To Use

- Use **CP157-L** Tapered Bushing (Accurate) for precise locating.
- Use **CP157-S** Tapered Bushing (Standard) for rough locating.

■ Mounting-Hole Dimension

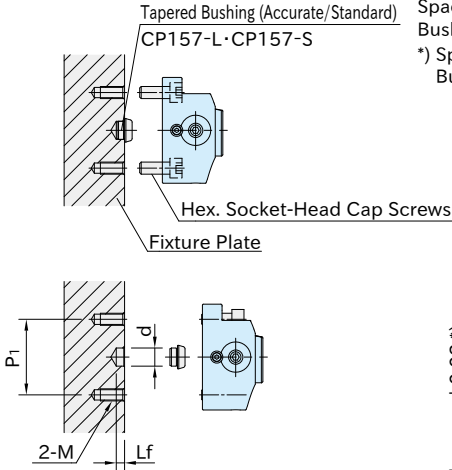

Size	d (H7)	Lf	M	P ₁
CP160-08040	12	5.5	M 8×1.25	50
CP160-12063	18	6.5	M12×1.75	75
CP160-16080	22	8	M16×2	100

Note: The tolerance of dimension "d" for Tapered Bushings (Standard) should be $^{+0.1}$.

■ Spacing Tolerance

Spacing tolerance should be ± 0.02 for Tapered Bushings (Accurate).

*) Spacing tolerance should be ± 0.1 for Tapered Bushings (Standard).

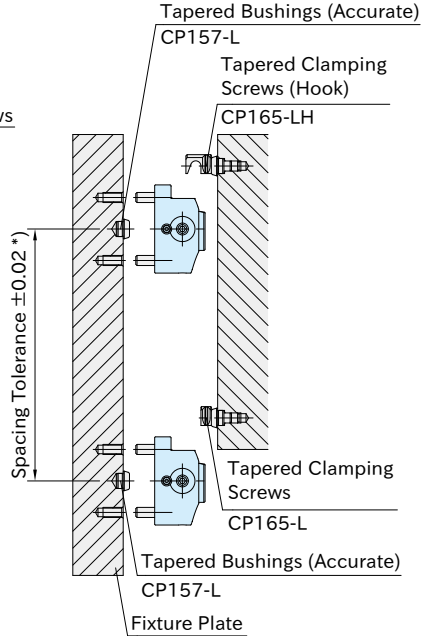

■ Layout

Use CP160-R for tightening from right side,
CP160-L for left side.

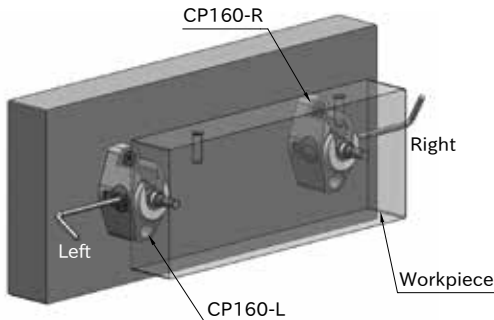

CP165-LH

TAPERED CLAMPING SCREWS (Hook)

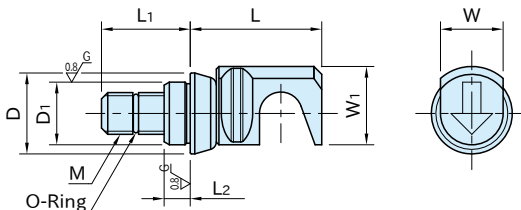

Tapered Bushing	Clamping Screw	O-Ring
S45C steel Black oxide finished Precision ground	SCM435 steel Quenched and tempered Black oxide finished	Nitrile rubber (NBR)

Part Number	M	D ₁ (g6)	L ₂	L ₁	D	L	W ₁	W	Proper O-Ring Size	Weight (g)	Proper Clamping Module
CP165-08001LH	M 8X1.25	12	5	17	15.5	25	15	12	SS050(CS1 /ID 5)	30	CP160-08040R,CP160-08040L
CP165-12001LH	M12X1.75	18	6	24	24.5	40	23.5	19	S 8 (CS1.5 /ID 7.5)	115	CP160-12063R,CP160-12063L
CP165-16001LH	M16X2	22	7.5	30	31.5	51	30	24	S 12 (CS1.5 /ID11.5)	235	CP160-16080R,CP160-16080L

Reference

Feature and How To Use in later page

CP165-L

TAPERED CLAMPING SCREWS

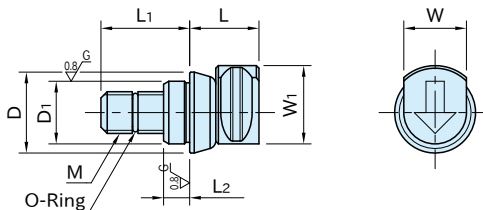

Tapered Bushing	Clamping Screw	O-Ring
S45C steel Black oxide finished Precision ground	SCM435 steel Quenched and tempered Black oxide finished	Nitrile rubber (NBR)

Part Number	M	D ₁ (g6)	L ₂	L ₁	D	L	W ₁	W	Proper O-Ring Size	Weight (g)	Proper Clamping Module
CP165-08001L	M 8X1.25	12	5	17	15.5	13	15	12	SS050(CS1 /ID 5)	22	CP160-08040R,CP160-08040L
CP165-12001L	M12X1.75	18	6	24	24.5	21.5	23.5	19	S 8 (CS1.5 /ID 7.5)	81	CP160-12063R,CP160-12063L
CP165-16001L	M16X2	22	7.5	30	31.5	27	30	24	S 12 (CS1.5 /ID11.5)	170	CP160-16080R,CP160-16080L

Reference

Feature and How To Use in later page

CP166-H

CLAMPING SCREWS (Hook)

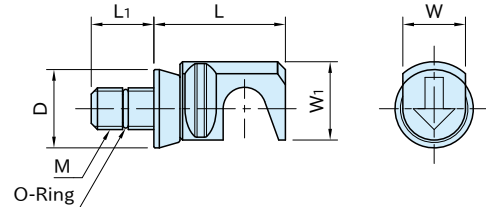

Tapered Bushing	Clamping Screw	O-Ring
S45C steel Black oxide finished	SCM435 steel Quenched and tempered Black oxide finished	Nitrile rubber (NBR)

Part Number	M	L ₁	D	L	W ₁	W	Proper O-Ring Size	Weight (g)	Proper Clamping Module
CP166-08001H	M 8×1.25	12	15	25	15	12	SS050(CS1 /ID 5)	26	CP160-08040R,CP160-08040L
CP166-12001H	M12×1.75	18	24	40	23.5	19	S 8 (CS1.5/ID 7.5)	103	CP160-12063R,CP160-12063L
CP166-16001H	M16×2	22	31	51	30	24	S 12 (CS1.5/ID11.5)	213	CP160-16080R,CP160-16080L

Reference

Feature and How To Use in later page

CP166

CLAMPING SCREWS

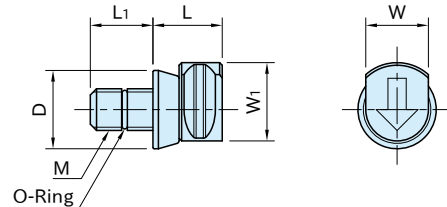

Tapered Bushing	Clamping Screw	O-Ring
S45C steel Black oxide finished	SCM435 steel Quenched and tempered Black oxide finished	Nitrile rubber (NBR)

Part Number	M	L ₁	D	L	W ₁	W	Proper O-Ring Size	Weight (g)	Proper Clamping Module
CP166-08001	M 8×1.25	12	15	13	15	12	SS050(CS1 /ID 5)	18	CP160-08040R,CP160-08040L
CP166-12001	M12×1.75	18	24	21.5	23.5	19	S 8 (CS1.5/ID 7.5)	69	CP160-12063R,CP160-12063L
CP166-16001	M16×2	22	31	27	30	24	S 12 (CS1.5/ID11.5)	147	CP160-16080R,CP160-16080L

Reference

Feature and How To Use in later page

Feature

- Each clamping screw has commercially available O-ring to prevent rotation and keep the direction of arrow marking.
- O-ring should be replaced by the customer when it is worn.

How To Use

Tapered Clamping Screws

Can be used for locating fixture plate or workpiece.

Clamping Screws

Can be used for just clamping.

■ Mounting-Hole Dimension

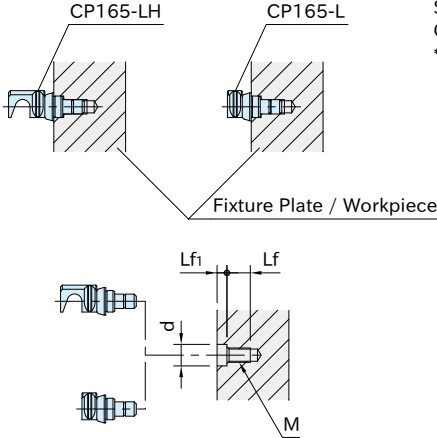

Size	d *)	Lf	Lf1	M
CP165-08001	12	13	5.5	M 8×1.25
CP165-12001	18	19	6.5	M12×1.75
CP165-16001	22	23	8	M16×2

*) • The hole tolerance should be $\begin{smallmatrix} 0.010 \\ 0.025 \end{smallmatrix}$ when Tapered Clamping Screws are always mounted on the fixture plate. Fixture plate and tapered bushing fit tightly and keep the repeatability without chip incursion.

• The hole tolerance should be H7 when mounting on workpiece. Tapered bushing can be easily mounted / removed.

■ Installation

1. Fully tighten the clamping screw on fixture plate or workpiece.

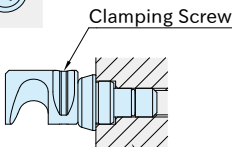

2. Turn the screw counterclockwise within one turn until the arrow marking points downward. (There is a gap between clamping screw and tapered bushing.)

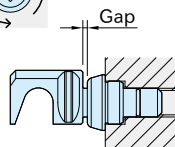

3. Install the clamping screws into the clamping modules.

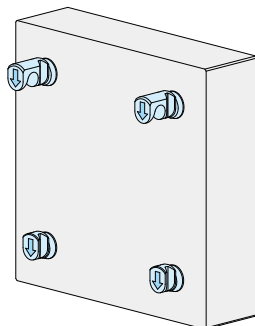

■ Spacing Tolerance

Spacing tolerance should be ± 0.02 for Tapered Clamping Screws.

**) Spacing tolerance should be ± 0.2 for Clamping Screws.

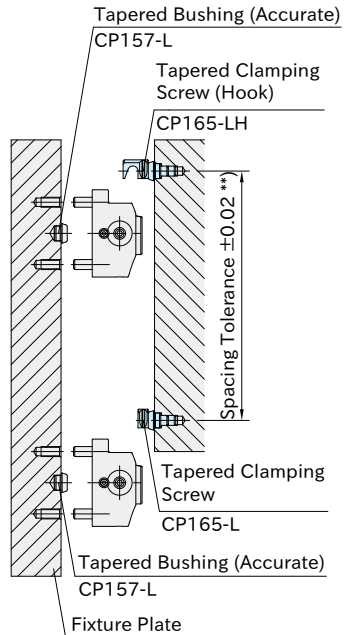

Note: Refer to the next page for the layout of the products.

Application Example

Tighten the hook type clamping screw firstly.
The first one becomes the reference.

The products should be positioned as shown below.

[CP165-LH](#) [CP165-L](#) Tapered Clamping Screws and [CP157-L](#) Tapered Bushings (Accurate) should be used together, and [CP166-H](#) [CP166](#) Clamping Screws and [CP157-S](#) Tapered Bushings (Standard) are also.

Note

Do not remove the hoists until the unit fully clamped.

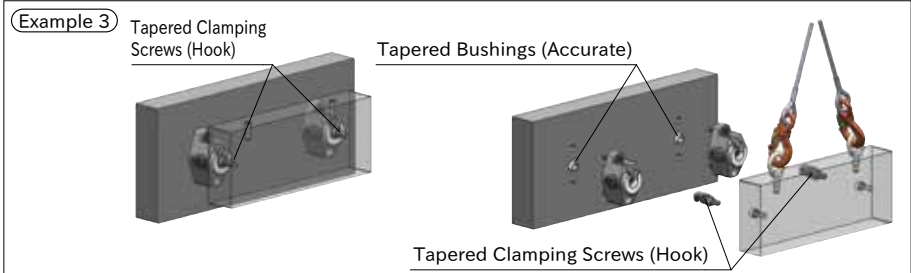
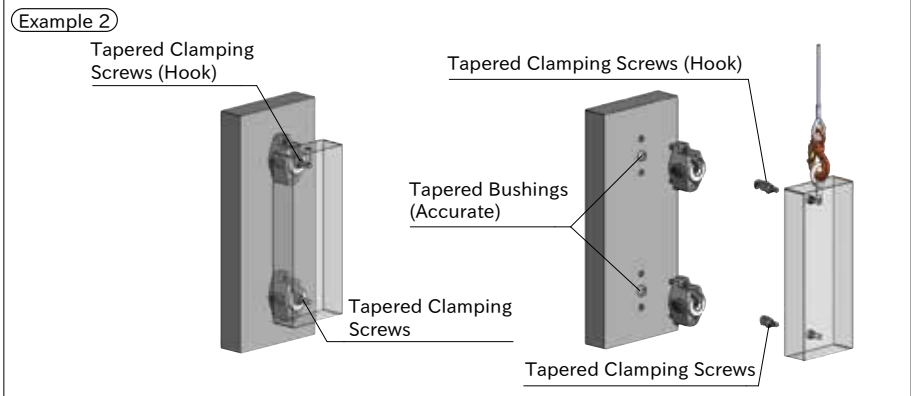
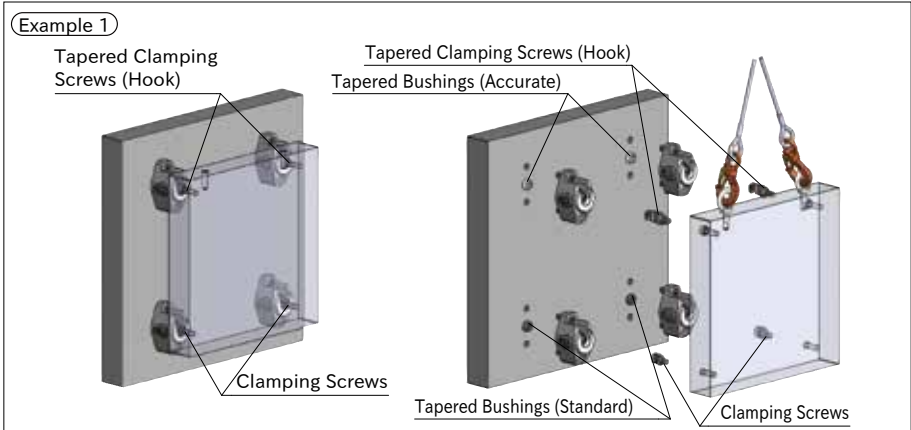

Note: Use [CP166-H](#) [CP166](#) Clamping Screws when locating of workpiece is not necessary.

Related Product

·[CP160](#) Clamping Modules (Hook)

·[CP165-LH](#) Tapered Clamping Screws (Hook)

·[CP165-L](#) Tapered Clamping Screws

·[CP166-H](#) Clamping Screws (Hook)

·[CP166](#) Clamping Screws

FORM HOLDING CLAMPS

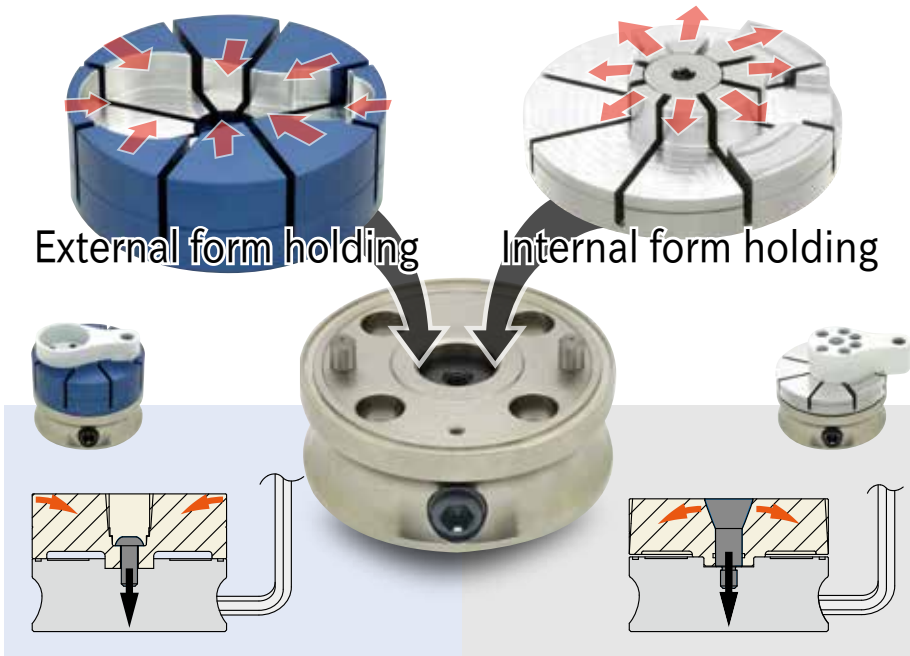

Clamp any shape! Hold on external / internal form!

FORM HOLDING CLAMPS

Form Holding Clamps with a machinable jaw are perfect for irregular-shaped workpieces. Simple workholding on external/internal form eliminates the need for custom fixtures.

Secure clamping for
odd shaped workpieces



Versatile workholding
by changing jaw



Quick clamping by
tightening cam cylinder



1 Prepare jaw

2 Machine jaw

3 Mount workpiece

4 Tighten cam cylinder

External



Internal



Application Example

Clamping Low Profile Workpiece

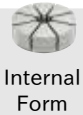
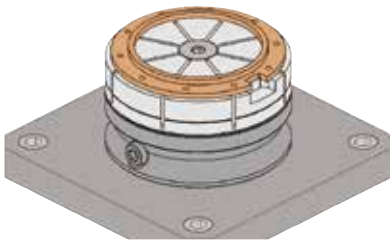

8 jaw sections distribute clamping force to workpiece for deformation prevention.

Note to control the tightening torque using adequate tools in reference to the data provided by the performance curve.

Multipul Workholding

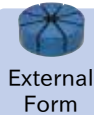

Small cylindrical body allows the multi-piece clamping in limited space.

Fixture for Temporal Job

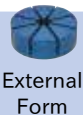
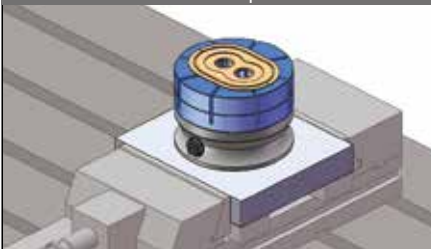

Can be mounted on the existing vise by attaching the clamp on plate.

Fixture for Turning Lathe

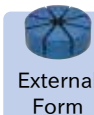
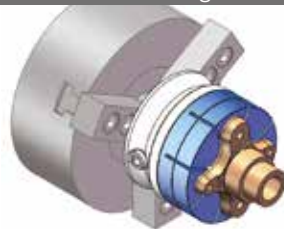

Can clamp odd shape that a chuck does not clamp.

CP122 Mounting-on-lathe Adapter is available.

CP125

FORM HOLDING CLAMPS



Note: Jaw is not included.

Body	Pull Cylinder	Cam Cylinder
S45C steel Electroless nickel plated	SCM415 steel Carburized-hardened Black oxide finish	SCM435 steel Quenched & tempered Black oxide finish

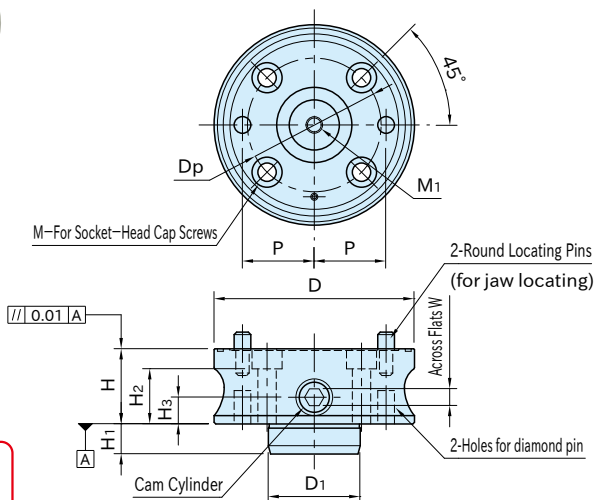

★Key Point

Can hold on external/
internal form.

Part Number	D	H (±0.01)	D ₁ (g6)	H ₁	M	H ₂	D _p	P (±0.02)	W	H ₃	M ₁
CP125-06501	65	35	28	12	M 6	27	42	22	8	12	M 8×1.25
CP125-09001	90	40	42	14	M 8	30	60	30		14	M10×1.5
CP125-12001	120	45	55	18	M10	33	80	43	10	16	
CP125-16001	160	50	63	24	M12	36	110	60		18	

Part Number	Allowable Screw Torque(N·m)	Weight (kg)	Proper Jaws					
			For External Form Holding			For Internal Form Holding		
			Part Number	Clamping Force(kN)	Clamping Stroke	Part Number	Clamping Force(kN)	Clamping Stroke
CP125-06501	15	0.8	CP126-06501	4.5	φ 0.3	CP127-06501	4.5	φ 0.3
CP125-09001	25	1.7	CP126-09001	7		CP127-09001	7	
CP125-12001	40	3.5	CP126-12001	10		CP127-12001	10	
CP125-16001		7.1	CP126-16001	12		CP127-16001		

Technical Information

- Part locating repeatability: ±0.03
- Jaw locating repeatability: ±0.02

Note

Do not tighten the cam cylinder without the workpiece set to prevent damage and deformation. Tightening with the torque beyond the allowable screw torque will lower the durability of the jaw.

Supplied With

- CP125-06501 : 1 pc. of Diamond Locating Pin (BJ722-06001)
- CP125-09001 : 1 pc. of Diamond Locating Pin (BJ722-08001)
- CP125-12001 : 1 pc. of Diamond Locating Pin (BJ722-10001)
- CP125-16001 : 1 pc. of Diamond Locating Pin (BJ722-12001)

Related Product

- CP126 Jaws for External Form Holding
- CP127 Jaws for Internal Form Holding
- BJ722 Diamond Locating Pin
- CP122 Mounting-on-lathe Adapters

Feature

Two optional jaws allow clamping a workpiece both on its external form and internal form.

JAW FOR EXTERNAL FORM HOLDING
CP126

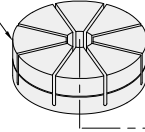

TAPERED SCREW FOR INTERNAL FORM HOLDING
CP127-B

JAW FOR INTERNAL FORM HOLDING
CP127

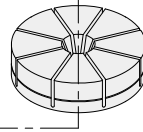

Note: CP125 does not include the jaw.

FORM HOLDING CLAMP
CP125

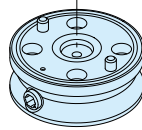

How To Use

Mounting Hole Dimension

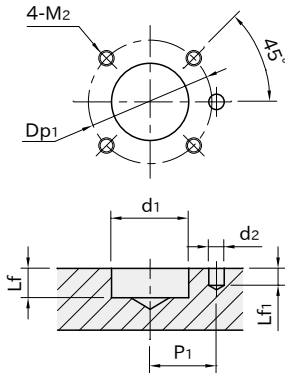

Part Number	d ₁ (H7)	Lf	d ₂ (G7)	Lf _i	P ₁ (±0.02)	M ₂	Dp ₁
CP125-06501	28	13	6	6	22	M 6×1	42
CP125-09001	42	15	8	8	30	M 8×1.25	60
CP125-12001	55	19	10	11	43	M10×1.5	80
CP125-16001	63	25	12	13	60	M12×1.75	110

Installation Instruction

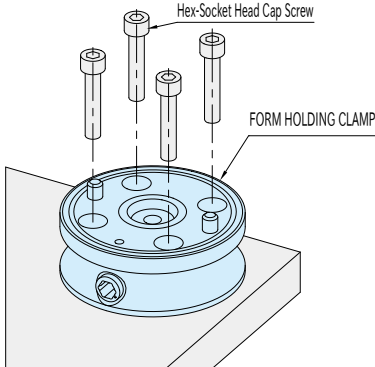

Insert an included diamond pin into the body for locating and secure the body to the fixture plate with 4 socket-head cap screws.

Note: Use either of the holes for diamond locating pin for your application.

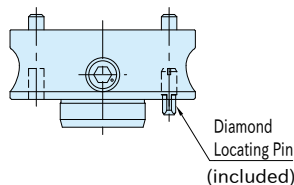

Dimension of Diamond Locating Pin

Part Number	Diameter
CP125-06501	φ 6h6
CP125-09001	φ 8h6
CP125-12001	φ 10h6
CP125-16001	φ 12h6

CP126

JAWS FOR EXTERNAL FORM HOLDING

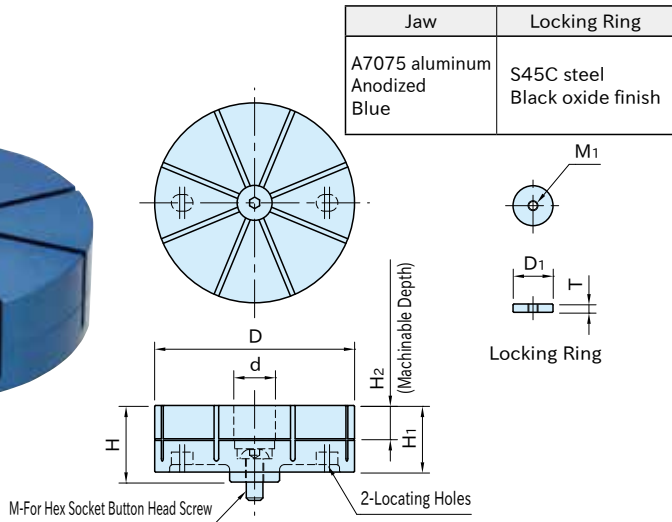
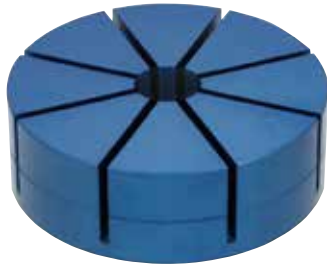

Part Number	D	d	H ₁	H ₂	M	H	M ₁	D ₁	T	Weight (kg)	Proper CP125 Clamps
CP126-06501	65	21	25	10	M 8×20L Across Flats 5	29	M5×0.8	20	4	0.2	CP125-06501
CP126-09001	90	25	35	15	M10×25L Across Flats 6	40	M6×1	24	5	0.5	CP125-09001
CP126-12001	120	25	40	20		1.1				CP125-12001	
CP126-16001	160	29	45	25	M12×25L Across Flats 8	52	M8×1.25	28	6	2.2	CP125-16001

Supplied With

- 1 pc. of O-ring
- 1 pc. of Locking Ring
- 1 pc. of Hex Socket Button Head Screw

Feature

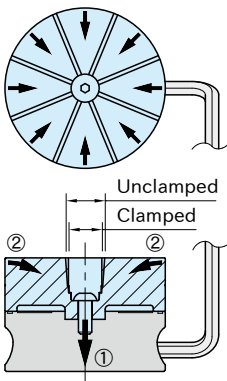

- The diaphragm clamping mechanism allows securely clamping a part with 8 jaw sections.
- 0.15mm clamping stroke of each jaw section is perfect for clamping of lost-wax parts, die-cast parts, extruded parts, solid-drawn parts, prefinished parts, etc.

- ① When the cam cylinder is tightened, the central bottom part of the jaw is pulled down.
- ② At the same time the 8 jaw sections tilt toward the center to clamp the external form of workpiece.

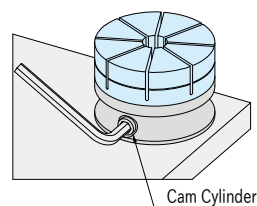

How To Use

1. Jaw Mounting

- Insert an O-ring to the groove on top surface of the Form Holding Clamp.
- Set a Jaw putting its locating holes onto the round locating pins and fix it with a hex socket button head screw.

Note: At jaw installation, ensure the cam cylinder is fully loosened by turning counterclockwise until it stops.

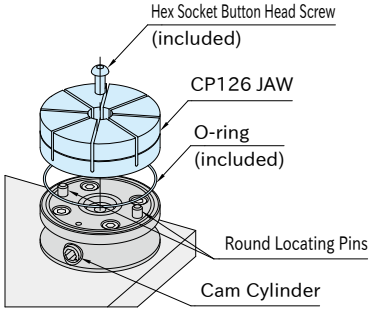

2. Jaw Machining

- 2-1. Set the locking ring in the jaw.
(Using a screw facilitates setting.)

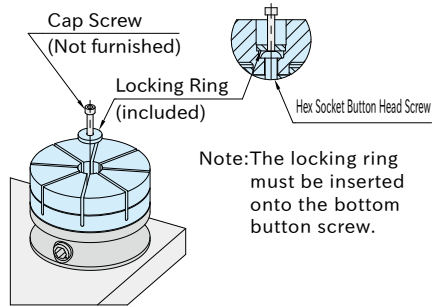

- 2-2. • Tighten the cam cylinder to clamp the locking ring. (Recommended Tightening Torque: 15N·m)
• After clamping the screw should be removed from the locking ring.

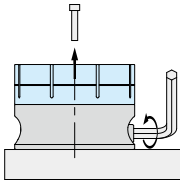

- 2-3. Machine the jaw to the contours of workpiece. (Do not machine the jaws beyond the machinable depth.)

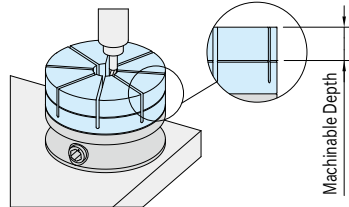

3. Workpiece Loading

- Loosen the cap screw to remove the locking ring.
- Load the workpiece and tighten the cam cylinder for clamping.

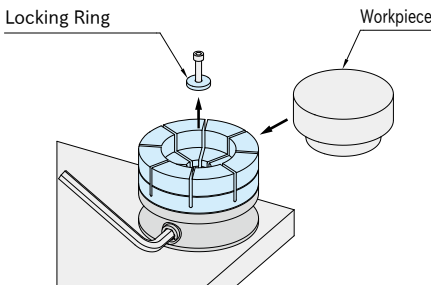

Performance Curve

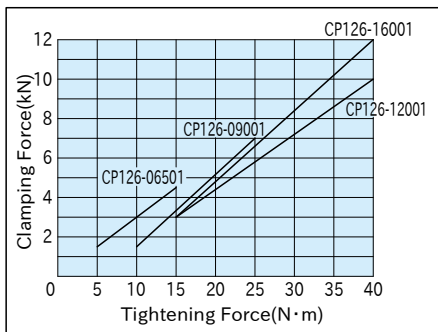

Note

Do not tighten the cam cylinder without the workpiece set to prevent damage and deformation. Tightening with the torque beyond the allowable screw torque will lower the durability of the jaw.

CP127

JAWS FOR INTERNAL FORM HOLDING

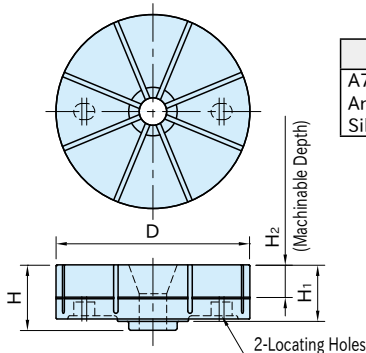

Jaw
A7075 aluminum
Anodized
Silver

Part Number	D	H ₁	H ₂	H	Weight (kg)	Proper	Proper
						CP125 Clamps	CP127-B Screws
CP127-06501	65	25	10	28.5	0.2	CP125-06501	CP127-06501B
CP127-09001	90	30	15	34.5	0.4	CP125-09001	CP127-09001B
CP127-12001	120	35	20	40.5	0.9	CP125-12001	CP127-12001B
CP127-16001	160	40	25	46.5	1.9	CP125-16001	CP127-16001B

Supplied With
1 pc. of O-ring

CP127-B

TAPERED SCREWS FOR INTERNAL FORM HOLDING

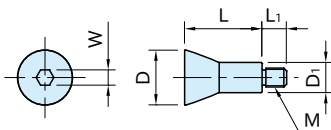

Body
SCM435 steel
Quenched and tempered
Electroless nickel plated

Part Number	D	L	M	L ₁	D ₁	W	Weight (g)	Proper CP127 Jaws
CP127-06501B	22.5	29	M 8x1.25	10	13.2	6	50	CP127-06501
CP127-09001B	27	35	M10x1.5	11	16	8	80	CP127-09001
CP127-12001B	29	41		13			100	CP127-12001
CP127-16001B	33	47	M12x1.75	14	18	10	150	CP127-16001

Feature

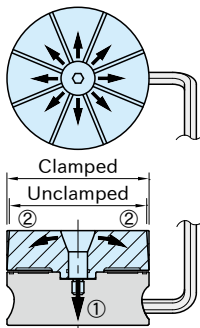

- The tapered screw expands the jaws towards eight directions to hold different irregularly-shaped workpieces securely.
- 0.15mm clamping stroke of each jaw section is perfect for clamping of lost-wax parts, die-cast parts, extruded parts, solid-drawn parts, prefinished parts, etc.

- ① When the cam cylinder is tightened, the tapered screw is pulled down.
- ② At the same time the 8 jaw sections expand to clamp the internal form of workpiece.

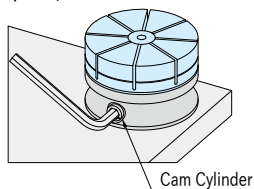

How To Use

1. Jaw Mounting

- Insert an O-ring to the groove on top surface of the Form Holding Clamp.
- Set a Jaw putting its locating holes onto the round locating pins and fix it with a tapered screw.

Note: At jaw installation, ensure the cam cylinder is fully loosened by turning counterclockwise until it stops.

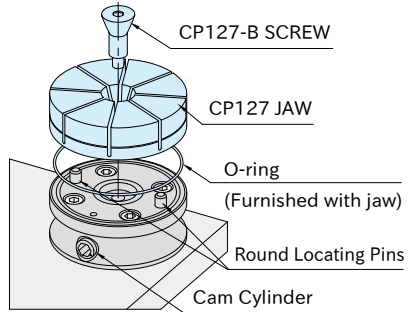

2. Jaw Machining

- 2-1. Loosen the cam cylinder fully and measure the dimension of the jaw for machining. Then tighten the cam cylinder until each jaw section expands 0.15mm.

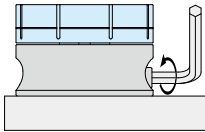

- 2-2. Machine the jaw to the contours of workpiece. (Do not machine the jaws beyond the machinable depth.)

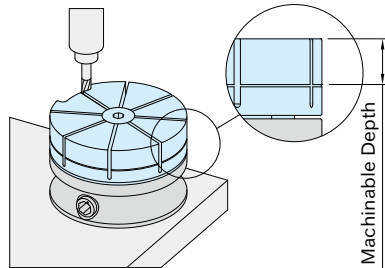

3. Workpiece Loading

After machining loosen the cam cylinder to set workpiece and tighten the cam cylinder again for clamping.

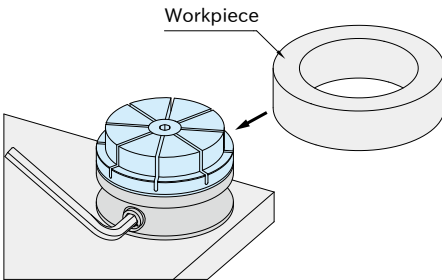

Performance Curve

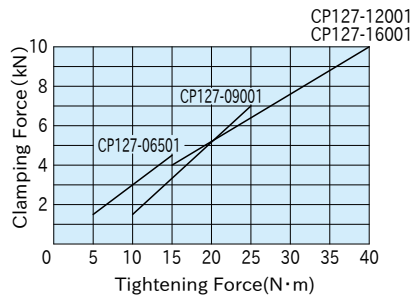

Note

Do not tighten the cam cylinder without the workpiece set to prevent damage and deformation. Tightening with the torque beyond the allowable screw torque will lower the durability of the jaw.

CP120

OD HOLDING CLAMPS

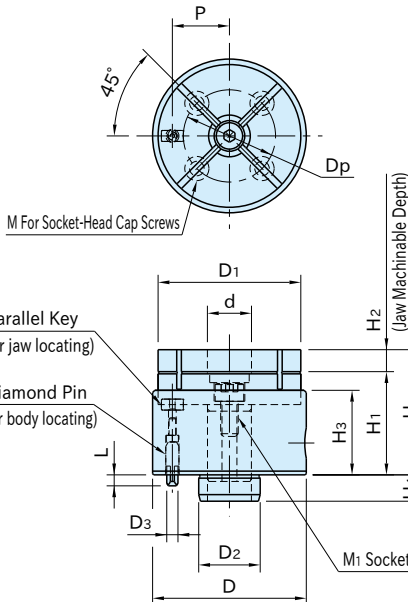

Body	Jaw
S45C steel Black oxide finish	A7075 aluminum Anodized Blue
Shaft / Locking Screw	Housing / Locking Ring
SCM435 steel Black oxide finish Quenched and tempered	S45C steel Black oxide finish

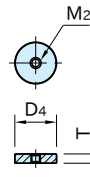

Locking Ring

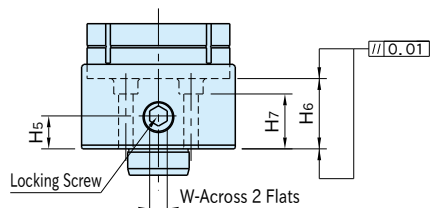

Part Number	D ₁	d	H	H ₂	D	H ₁	H ₃	H ₆ (±0.01)	D ₂ (g6)	H ₄	M	H ₇	D _p	D ₃ (h6)	L	P (±0.02)
CP120-06501	65	19	57	10	70	47	39	32	28	12	M6	25	42	6	5	26
CP120-09001	90	23	72	15	95	57	46	38	42	14	M8	28	60	8	7	36

Part Number	W	H ₅	M ₁	M ₂	D ₄	T	Clamping Force (kN)	Allowable Screw Torque (N·m)	Weight (kg)
CP120-06501	8	15	M 8X1.25-15L	M4X0.7	18	4	4	60	1.1
CP120-09001	10	17	M10X1.5 -20L	M5X0.8	22	6	6	100	2.6

Technical Information

- Part locating repeatability: ±0.03
- Jaw locating repeatability: ±0.02

Supplied With

- 1 of locking ring
- 1 of diamond pin
- 1 of socket-head cap screw

Note

- Do not tighten the clamp screw without the workpiece set to prevent damage and deformation.
- Do not machine the jaw beyond the machinable depth.

Related Product

- CP121 Jaws
- CP122 Mounting-on-lathe Adapters

Feature

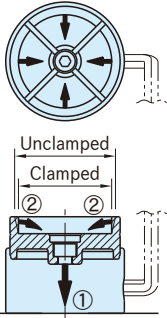

- When the locking screw is tightened, the central bottom part of the jaw is pulled down.
- At the same time the 4 jaw sections tilt toward the center to clamp the circumference of a part.

- The diaphragm clamping mechanism allows securely clamping a part with 4 jaw sections.
- Different irregularly-shaped parts can be clamped.
- 0.15mm clamping stroke of each jaw section is perfect for clamping of lost-wax parts, die-cast parts, extruded parts, solid-drawn parts, prefinished parts, etc.

How To Use

1. Body Mounting

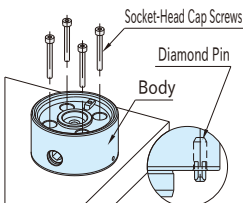

Insert an included diamond pin into the body for locating, and then secure the body to the fixture plate with 4 socket-head cap screws.

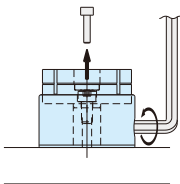

- Tighten the locking screw to clamp the locking ring. (Tighten with half of the allowable screw torque or more.) After clamping the screw, remove the screw from the locking ring.

2. Jaw Setting

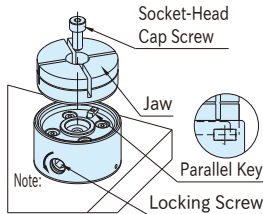

Engage the keyway on the bottom of the jaw with the parallel key on the top of the body, and then secure the jaw with an included cap screw. Note: At jaw installation, ensure the locking screw is fully loosened by turning it counterclockwise until it stops.

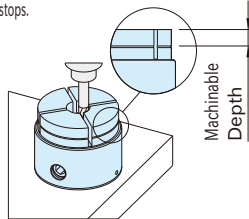

- Machine the jaw to the contours of workpiece.

3. Jaw Machining

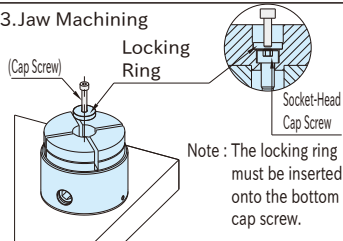

- Set the locking ring in the jaw. (using a cap screw facilitates setting)

4. Workpiece Loading

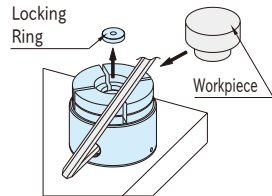

- Loosen the cap screw to remove the locking ring.
- Load the workpiece and tighten the clamping screw for clamping.

How To Install

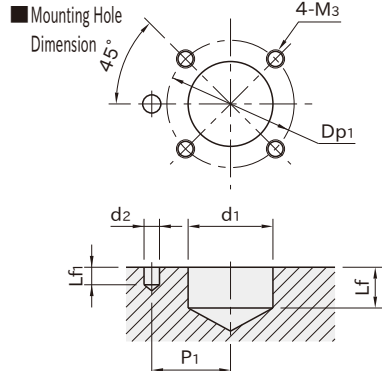

Part Number	d1 (H7)	Lf	d2 (G7)	Lf1	P1 (±0.02)	M3	Dp1
CP120-06501	28	13	6	6	26	M6×1	42
CP120-09001	42	15	8	8	36	M8×1.25	60

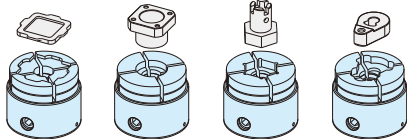

- Tightening the locking screw on the side of the body allows holding a part on its circumference.
- Machinable jaws allow clamping parts of various shapes.
- Ideal way to hold parts for machining on small-size machining centers, tapping centers, small-size 5-axis machines, CNC rotary tables, etc.

CP121

JAWS

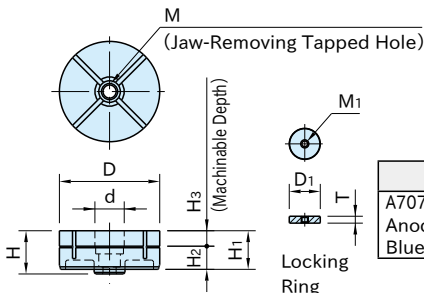
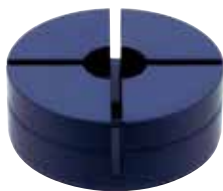

Jaw	Locking Ring
A7075 aluminum Anodized Blue	S45C steel Black oxide finish

Part Number	D	d	H ₁	H ₃	M	H	H ₂	M ₁	D ₁	T	Weight (g)	OD Holding Clamps	
CP121-06501	65	19	25	10	M10X1.5 (Prepared hole ϕ 8.5)	28	15	M4X0.7	18	4	170	CP120-06501	AMCH080-5W
CP121-09001	90	23	34	15	M12X1.75 (Prepared hole ϕ 10.2)	39	19	M5X0.8	22	6	470	CP120-09001	AMCH100-5W

Note
Jaw has lifecycle.

Feature

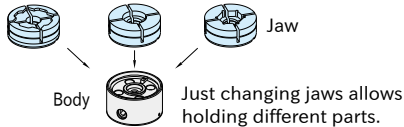

How to Remove Jaw
When it is hard to remove the jaw by hand, screw a bolt into the jaw-removing tapped hole to push it against the body, for easier removal.

CP122

MOUNTING-ON-LATHE ADAPTERS

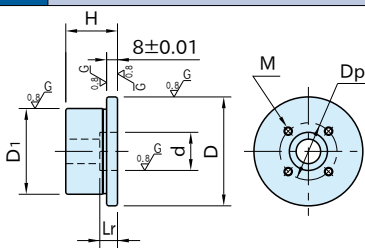

Body
SCM415 steel Black oxide finish Carburized-hardened

Part Number	d (H7)	L _r	D ₁ (± 0.01)	H	D	M	D _p	Weight (g)	Form Holding Clamps	OD Holding Clamps
CP122-06501	28	13	63	38	80	M6X1 Depth 12	42	910	CP125-06501	CP120-06501
CP122-09001	42	15	80	43	100	M8X1.25 Depth 16	60	1600	CP125-09001	CP120-09001

How To Use

Note : A diamond pin included in an OD Holding Clamp is NOT REQUIRED in this combination use.



CP124

OD HOLDING CLAMPS (Wedge Style/Square)



CP124-***01



CP124-***02

Body	Wedge
A6N01 aluminum Anodized Silver	SCM440 steel Black oxide finished Quenched & tempered

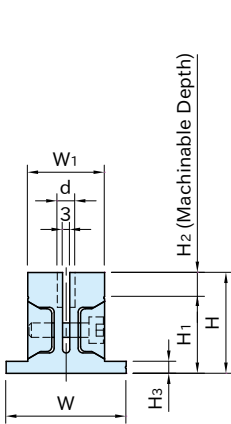

CP124-***01

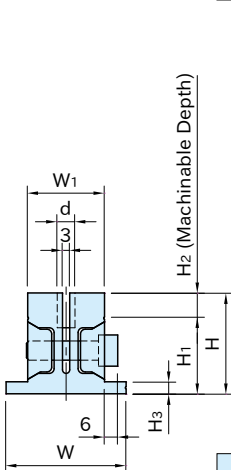
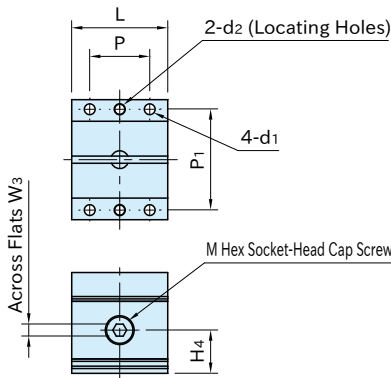

CP124-***02

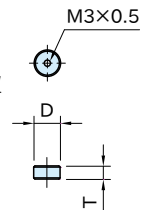
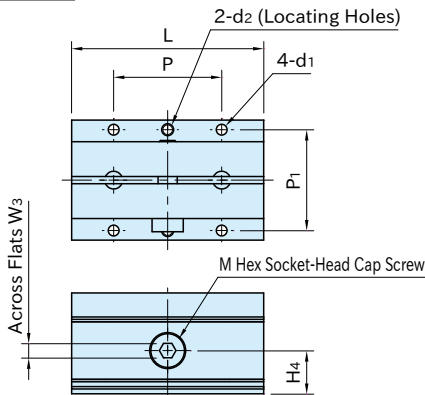

Locking Button

Part Number	W ₁	d	L	H	H ₂	W	H ₃	H ₁	d ₂ (H7)	d ₁	P	P ₁	M
CP124-03201	32	7.4	40	42	10	50	5	32	5	4.5	25	42	M 6×1 -25L
CP124-03202			80										M 8×1.25-30L
CP124-05001	50	11.4	50	63	15	72	7	48	6	5.5	30	62	M10×1.5 -40L
CP124-05002			100										M12×1.75-45L

Part Number	W ₃	H ₄	D	T	Clamping Force (kN)	Allowable Screw torque (N·m)	Weight (kg)
CP124-03201	5	18	7	3.5	2.5	7.5	0.22
CP124-03202	6					14	0.42
CP124-05001	8	27	11	5.5	5.5	26	0.62
CP124-05002	10					46	1.29

Technical Information

Locating Repeatability : ±0.08

Supplied With

- 1 of locking button for CP124-***01
- 2 of locking button for CP124-***02
- 2 of parallel pin(m6 tolerance)
- φ5×10L for CP124-***01
- φ6×15L for CP124-***02

Feature

- When the clamp screw is tightened, both jaws tilt toward the center to clamp the circumference of the workpiece.
- The clamping stroke is 0.5mm.
- Cutting the machinable jaw to the contour of workpiece allows holding different shapes.
- Simple and compact design permits multiple-parts holding arrangement.

How To Use

■ Mounting-Hole Dimension

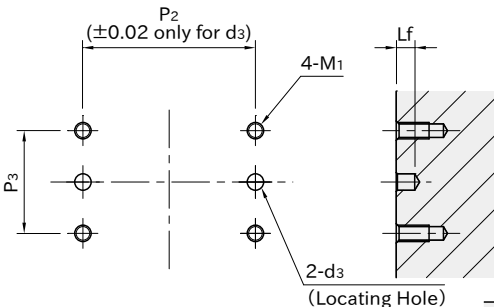

Use the included parallel pin for locating.

Note

- Do not tighten the clamp screw without the workpiece set to prevent damage and deformation.
- Do not machine the jaws beyond the machinable depth

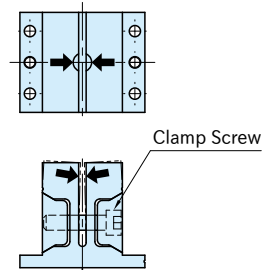

Part Number	d ₃ (H7)	L _f	M ₁	P ₂	P ₃
CP124-03201	5	5	M4×0.7	42	25
CP124-03202					45
CP124-05001	6	8	M5×0.8	62	30
CP124-05002					58

Continuing to next page

How to Machine Jaw

1. Setting the locking button

Insert the locking button into the jaw, and then tighten the clamp screw to fasten the locking button.
(Using a cap screw facilitates setting)

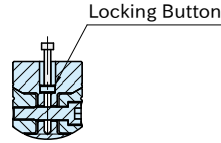
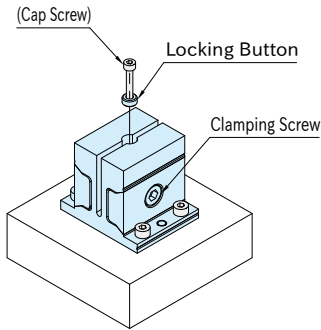

Note: The locking button must be inserted onto the bottom.

2. Machining the jaw

Cut the jaw to the contours of the workpiece.

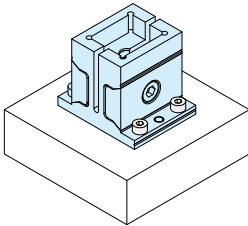

Note: Do not cut beyond the machinable depth.

3. Workpiece Loading

Loosen the clamp screw to remove the locking button. Load the workpiece and tighten the clamp screw for clamping.

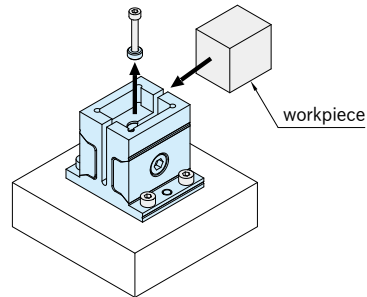

Application Example

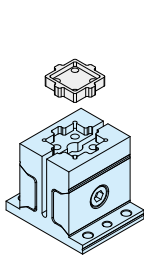

Single-station mode
on the short-type clamp

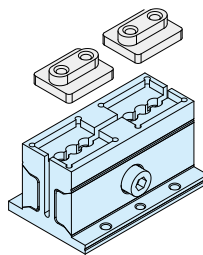

Dual-station mode
on the long-type clamp

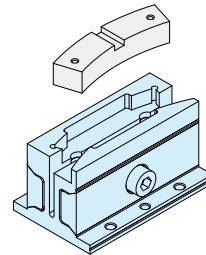

Single-station mode
on the long-type clamp



CP123

OD HOLDING CLAMPS (Wedge Style/Round)



Body	Wedge
S45C steel Black oxide finished	S45C steel Black oxide finished Quenched & tempered

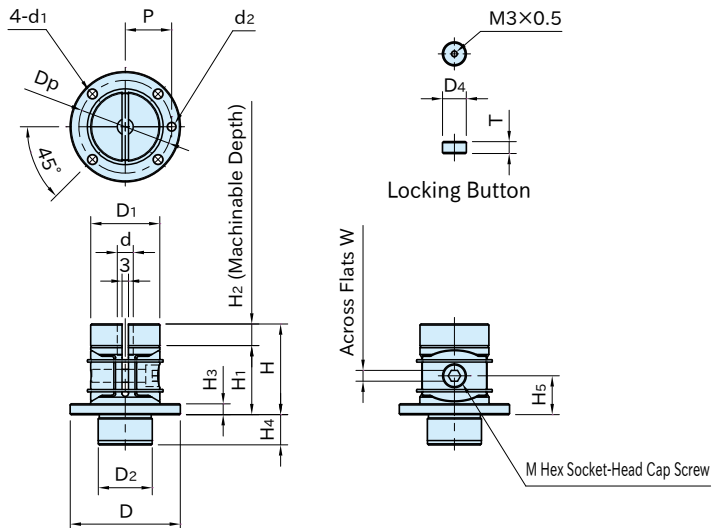

Part Number	D ₁	d	H	H ₂	D	H ₁	H ₃	D ₂ (g7)	H ₄	d ₁	D _p	d ₂	P
CP123-03201	32	7.4	42	10	51	32	5	25	14	4.5	43	5	21.5
CP123-05001	50	11.4	63	15	75	48	7	40	19	5.5	65	6	32.5

Part Number	M	W	H ₅	D ₄	T	Clamping Force (kN)	Allowable Screw Torque (N·m)	Weight (kg)
CP123-03201	M 6×1 -25L	5	18	7	3.5	3	9	0.33
CP123-05001	M10×1.5-35L	8	27	11	5.5	7	42	1.2

Technical Information

Part Locating Repeatability ±0.08

Supplied With

- 1 of locking button
- Spring pin
(φ 5×10L for CP123-03201)
(φ 6×14L for CP123-05001)

Note

- Do not tighten the clamp screw without the workpiece set to prevent damage and deformation.
- Do not machine the jaws beyond the machinable depth.

Feature

- When the clamp screw is tightened, both jaws tilt toward the center to clamp the circumference of the workpiece.
- The clamping stroke is 0.5mm.
- Cutting the machinable jaw to the contour of workpiece allows holding different shapes.
- Simple and compact design permits multiple-parts holding arrangement.

How To Use

■ Mouting-Hole Dimension

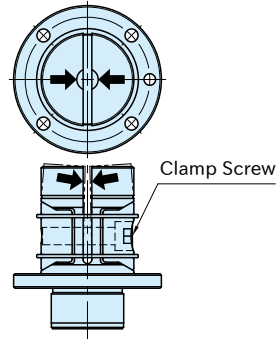
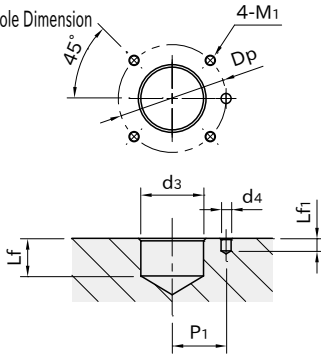

Part Number	d ₃ (H7)	L _f	d ₄ ($\begin{smallmatrix} +0.12 \\ 0 \end{smallmatrix}$)	L _{f1}	P ₁ (±0.05)	M ₁	D _p
CP123-03201	25	15	5	5	21.5	M4×0.7	43
CP123-05001	40	20	6	7	32.5	M5×0.8	65

■ How to Machine Jaw

1. Setting the locking button

Insert the locking button into the jaw, and then tighten the clamp screw to fasten the locking button. (Using a cap screw facilitates setting)

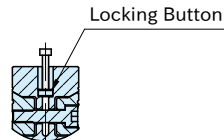
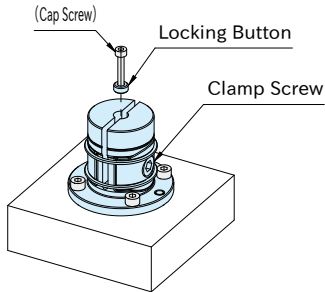

Note: The locking button must be inserted onto the bottom.

2. Machining the jaw

Cut the jaw to the contours of the part.

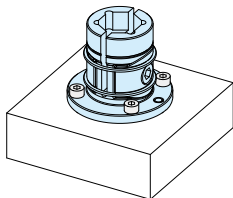

Note: Do not cut beyond the machinable depth.

3. Loading the part

Loosen the clamp screw to remove the locking button. Load the part and tighten the clamp screw for clamping.

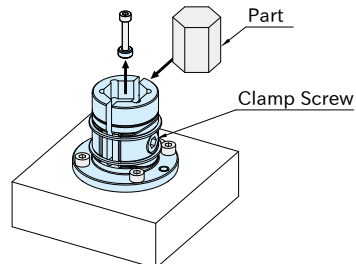

CP131

COMPACT ID HOLDING CLAMPS



CP131-A



CP131-B

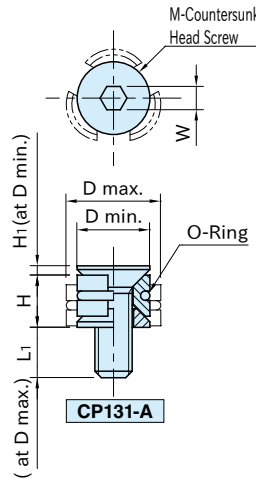

CP131-A

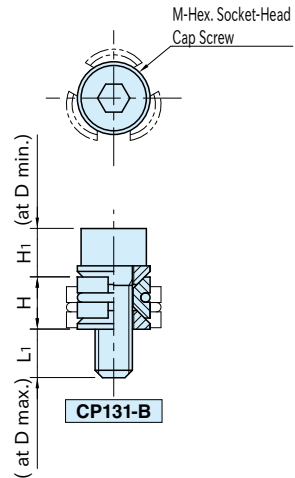

CP131-B

Jaw	Washer	O-Ring
SNCM439 steel Black oxide finished HRC33-39	SCM435 steel Black oxide finished	Fluoro rubber

Part Number	D		H		H ₁	M	L ₁	W
	min.	max.	D min.	D max.				
CP131-04001A	8	10.3	5.5	4.6	0.9	M4×0.7 -12L	7.3	2.5
CP131-05001A	10	12.3	6.4	5.6	1.1	M5×0.8 -15L	9.1	3
CP131-06001A	12	16.3	8.6	7	1.3	M6×1 -18L	11.2	4
CP131-08001A	16	22	11.5	9.4	1.6	M8×1.25-25L	16.2	5
CP131-04001B	8	10.3	5.5	4.6	5.1	M4×0.7 -12L	7.1	3
CP131-05001B	10	12.3	6.4	5.6	6.2	M5×0.8 -15L	9	4
CP131-06001B	12	16.3	8.6	7	7.9	M6×1 -18L	10.6	5
CP131-08001B	16	22	11.5	9.4	10.4	M8×1.25-25L	15.4	6

Part Number	Clamping Force (kN)	Allowable Screw Torque (N·m)	Weight (g)	Proper O-ring
CP131-04001A	0.9	2.1	3	SS050(CS1 /ID 5)
CP131-05001A	1.5	4.3	5	SS070(CS1 /ID 7)
CP131-06001A	2.1	7.3	9	S 8 (CS1.5 /ID 7.5)
CP131-08001A	4	18	22	S 12 (CS1.5 /ID11.5)
CP131-04001B	1.5	2.7	4	SS050(CS1 /ID 5)
CP131-05001B	2.5	5.4	7	SS070(CS1 /ID 7)
CP131-06001B	5	9.1	11	S 8 (CS1.5 /ID 7.5)
CP131-08001B	9	25	28	S 12 (CS1.5 /ID11.5)

Feature

- These clamps hold the inside diameter of the workpiece.
- The wedge construction allows powerfully clamping the workpiece.
- Long clamping stroke is ideal for holding as-cast or roughly-finished holes.

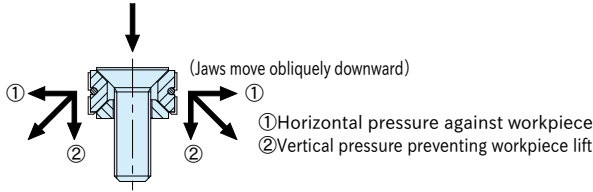

How To Use

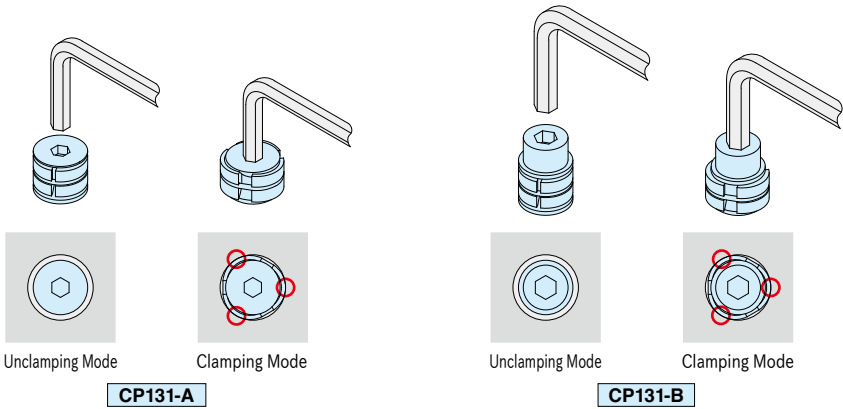

Note: The clamp makes a line contact with the workpiece at the clamping mode. This contact can mark the surface of the workpiece depending on its materials, and using these clamps for accurately finished holes is not recommended.

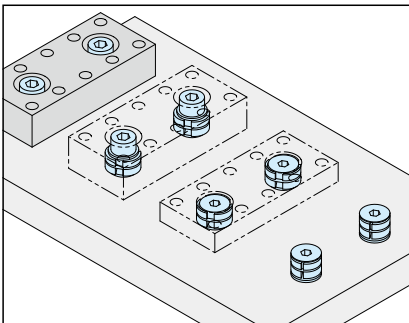

Example of application where two Compact ID Holding Clamps are used.

Note

For accurate locating, use these clamps with a locator as shown below.

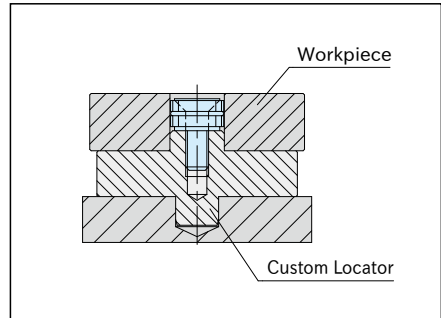

CP130

ID HOLDING CLAMPS

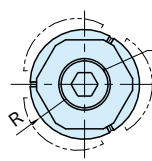
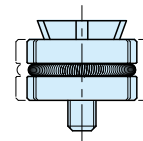
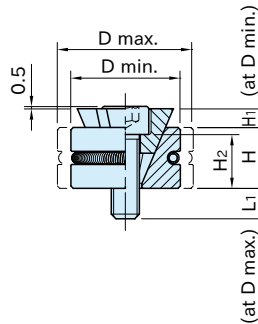
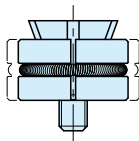
M-Hex. Socket-Head
Cap Screw

Body/Jaw	Spring
SKD61 steel Quenched & tempered Black oxide finished HRC47-53	SUS304 stainless steel

Part Number	D		H	H ₁	R	H ₂		L ₁ *)	M
	min.	max.				min.	max.		
CP130-04001	19.5	24	9	2.5	R 9.5	8	2.6	9.4	M4×12L
CP130-06001	23.5	29	13	4	R11.5	11.5	5	13	M6×18L
CP130-08001	28.5	36	17	5.5	R14	15	6	19	M8×25L

Part Number	Clamping Force (kN)	Allowable Screw Torque (N·m)	Weight (g)
CP130-04001	2	3.2	19
CP130-06001	5	10.5	43
CP130-08001	9	25	89

*) The stated values are only for use of the proper cap screws.

Feature

- These clamps hold the inside diameter of the workpiece.
- The wedge construction allows powerfully clamping the workpiece.
- Long clamping stroke is ideal for holding as-cast or roughly-finished holes.

How To Use

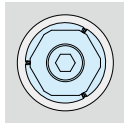
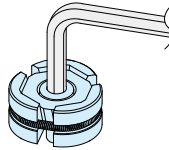
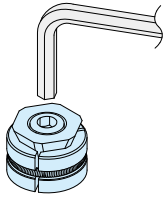

Unclamping Mode

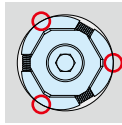

Clamping Mode

Note: The clamp makes a line contact with the workpiece at the clamping mode. This contact can mark the surface of the workpiece depending on its materials, and using these clamps for accurately finished holes is not recommended.

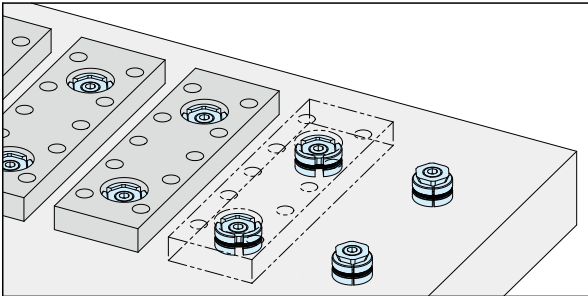

Example of application where two ID Holding Clamps are used.

Note

For accurate locating, use these clamps with a locator as shown below.

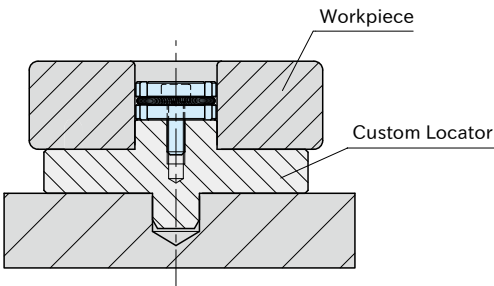

CP135

SPIRAL CAM CLAMPS



CP135-A



CP135

★Key Point

Space saving.
Long clamping stroke.

Spiral Cam Clamp	Clamping Plate
SCM440 steel Black oxide finished HRC33-39	SUS304CSP stainless steel

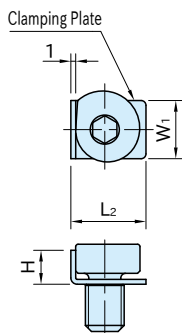

CP135-A

(With Clamping Plate)

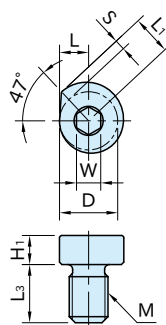

CP135

(Without Clamping Plate)

Part Number	S	L	L ₁	D	M	H ₁	L ₃	W	Allowable Screw Torque (N·m)	Clamping Force (kN)
CP135-06001	1.8	5	6.8	10	M 6×1	5	9	4	7.4	2.2
CP135-08001	2.2	6	8.2	12	M 8×1.25	6	12	5	18	4.7
CP135-10001	2.5	7	9.5	14	M10×1.5	7	15	6	35	7.9
CP135-12001	2.9	8	10.9	16	M12×1.75	8	18	8	60	14

CP135-A (With Clamping Plate)

Part Number	H	W ₁	L ₂	Clamping Plate	Weight (g)
CP135-06001A	6	10	13	CP135-06001P	7
CP135-08001A	7	12	15.5	CP135-08001P	13
CP135-10001A	8	14	18	CP135-10001P	21
CP135-12001A	9	16	20	CP135-12001P	33

CP135 (Without Clamping Plate)

Part Number	Weight (g)
CP135-06001	6
CP135-08001	11
CP135-10001	19
CP135-12001	30

CP135-L

SPIRAL CAM CLAMPS



One-Touch type is available.

Feature

- The spiral cam provides quick and powerful clamping.
- The simple design keeps cost low and the small size allows more workpieces per load.
- Clamping Plate avoids marring workpiece surfaces.

How To Use

■ Mounting Hole Dimension

With Clamping Plate

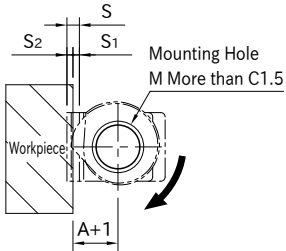

Without Clamping Plate

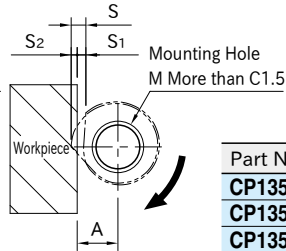

Part Number	A	S	S ₁	S ₂	M
CP135-06001	5.9	1.8	0.9	0.9	M 6X1
CP135-08001	7.1	2.2	1.1	1.1	M 8X1.25
CP135-10001	8.3	2.5	1.3	1.2	M10X1.5
CP135-12001	9.5	2.9	1.5	1.4	M12X1.75

Note: Dimension A and A+1 are the recommended distances between the mounting hole and the end of the workpiece.

Note

Tighten Spiral Cam Clamp fully and loosen it about one turn. Then mount a workpiece.

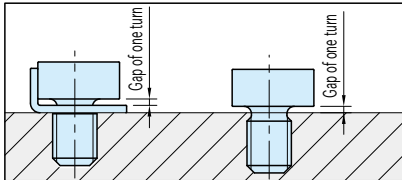

- Tighten clockwise to clamp the workpiece.
- Mount a stop on the right side of the workpiece.

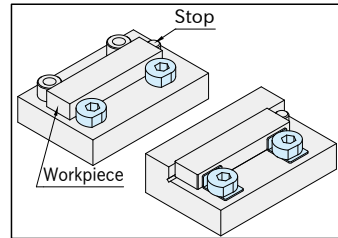

CP135-P

CLAMPING PLATES



Stainless Steel

IMA O

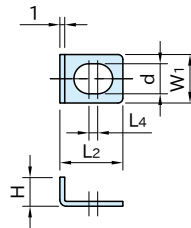
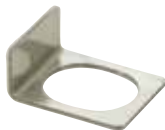

Clamping Plate

SUS304CSP
stainless steel

Part Number	H	W ₁	L ₂	d	L ₄	Weight (g)
CP135-06001P	6	10	13	6.2	1.8	1
CP135-08001P	7	12	15.5	8.2	2.2	2
CP135-10001P	8	14	18	10.2	2.6	2
CP135-12001P	9	16	20	12.2	2.9	3

BJ161

CAM CLAMPS

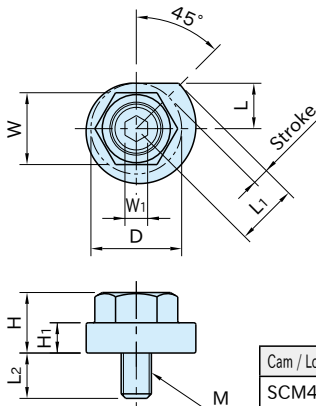

Cam / Locking Screw	Flanged Collar
SCM435 steel Quenched and tempered Black oxide finish	SK95 steel Quenched and tempered Black oxide finish

Part Number	Stroke	L	L ₁	D	H ₁	M	L ₂	H	W	W ₁
BJ161-08001	4.4	12	16.4	24	8	M 8×1.25	12	16	19	6
BJ161-10001	5.5	15	20.5	30	10	M10×1.5	15	20	24	8
BJ161-12001	6.2	17	23.2	34	12	M12×1.75	18	24	27	10

Part Number	Allowable Screw Torque (N·m)	Clamping Force (kN)	Weight (g)
BJ161-08001	50	5.2	55
BJ161-10001	75	8	110
BJ161-12001	90	9.3	185

Feature

- Allows loading and unloading a part faster.
- Compact design

How To Use

To install, lock the flanged collar into the cam using the locking screw and then tighten up the cam with a wrench.

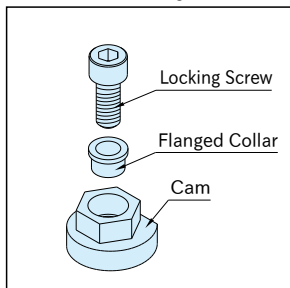

Parts Breakdown

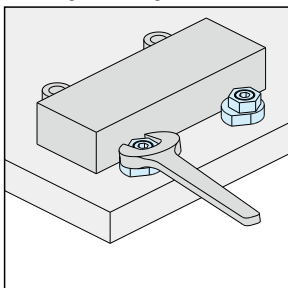

Provides positive clamping

BJ162

CAM EDGE CLAMPS



Body / Jaw	Cam
SCM440 steel Quenched and tempered Black oxide	SCM435 steel Quenched and tempered Black oxide

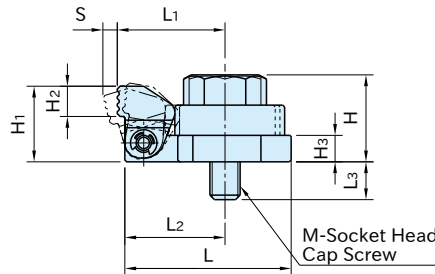
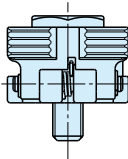
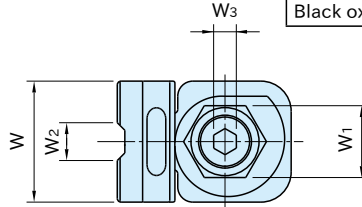

Part Number	H ₁	S	W	W ₂	H ₂	L ₁	L	L ₂	H ₃	M	L ₃	H	W ₁
BJ162-08001	20	4	32	10	8	28.5	44	26.5	7	M 8×1.25-30L	15	23	19
BJ162-10001	25	5	40	12	10	35	54	33	9	M10×1.5 -35L	16	29	24
BJ162-12001	30	5.5	46	14	12	39.5	62	37.5	11	M12×1.75-40L	17	35	27

Part Number	W ₃	Clamping Force (kN)	Allowable Screw Torque (N·m)	Weight (g)
BJ162-08001	6	3.5	45	160
BJ162-10001	8	5.5	55	310
BJ162-12001	10	7	70	490

How To Use

Secure the body and the flanged collar with a socket head cap screw, and then turn the the cam with a wrench to clamp a workpiece.

Related Product



One-Touch type is available.
[QLSC](#) CAM EDGE CLAMPS

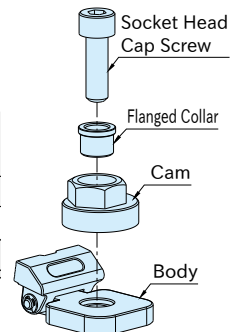
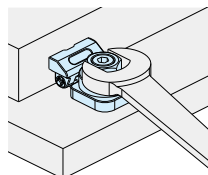

QLSCL

COMPACT LOW-PROFILE CAM EDGE CLAMPS



Body	Jaw / Cam
S45C steel Black oxide finished	SCM440 steel Black oxide finished HRC39-45

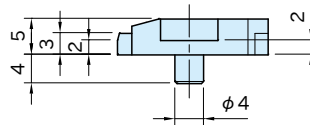
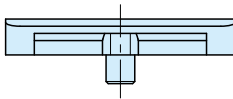
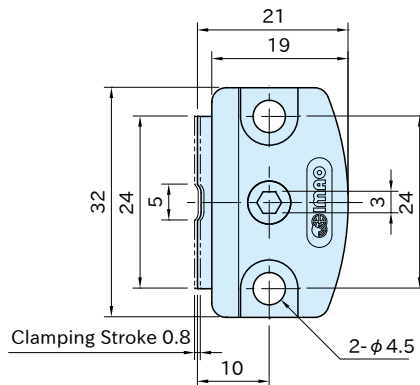

Part Number	Allowable Screw Torque (N·m)	Clamping Force (kN)	Weight (g)
QLSCL05NR	2.1	1.3	18

Feature

Designed to prevent part lift.

How To Use

- Low head cap screws do not project from the body.
- Turning the cam with a hex wrench allows the cam to project the jaw for clamping. When the cam is turned back for unclamping, the loaded spring lets the jaw return to the original position.

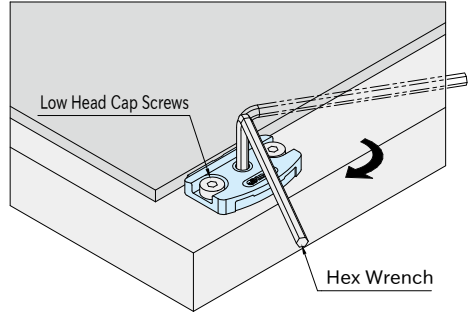

Mounting-Hole Dimension

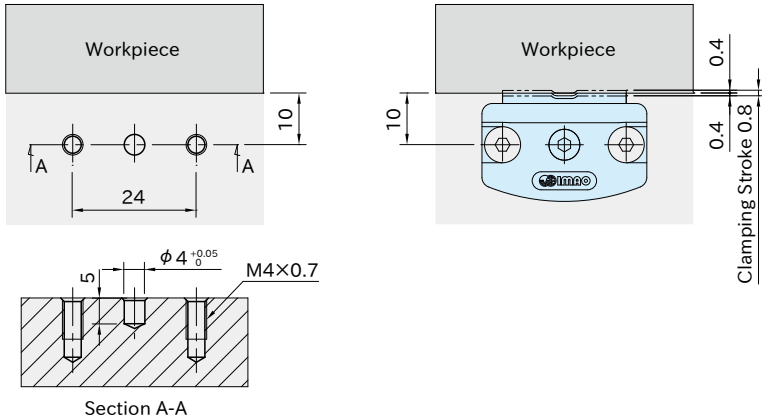

Note

Ensure that mounting surfaces are finished to $\sqrt[6.3]{6.3a}$ or better, without any scratches or dents.

Performance Curve

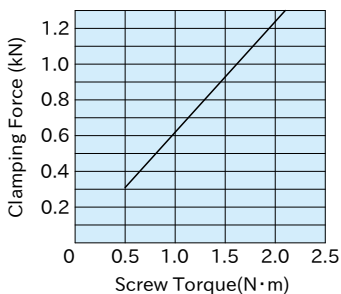

QLSCL-NR

LOW-PROFILE CAM EDGE CLAMPS



Body	Jaw / Cam
S45C steel Black oxide finish	SCM440 steel Quenched and tempered Black oxide finish

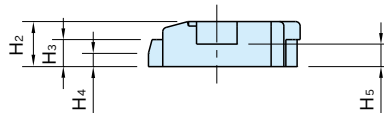
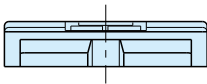
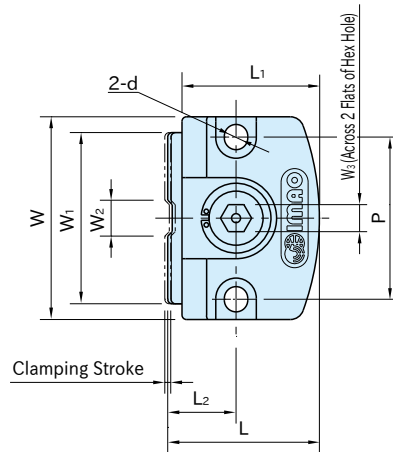

Part Number	Clamping Stroke	W ₁	W ₂	H ₃	H ₄	L ₂	W	L	H ₂	d	P	H ₅	L ₁	Clamping Mechanism
QLSCL10NR	1	38	8	6	3	15	45	33.5	10	5.2	36	5	30.5	Spiral Cam
QLSCL15NR	2	60	12	9	5	22	70	50	15	8.2	55	7	46	Cam Angle : 4°

Part Number	W ₃	Allowable Screw Torque (N·m)	Clamping Force (kN)	Weight (g)
QLSCL10NR	6	10	4	85
QLSCL15NR	10	27	6	290

Feature

Designed to prevent part lift.

How To Use

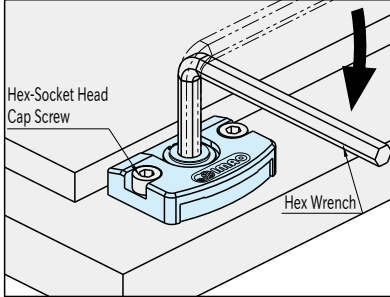

Turning the wrench allows the cam to project the jaw for clamping.

When the wrench is turned back for unclamping, the loaded spring lets the jaw return to the original position.

Performance Curve

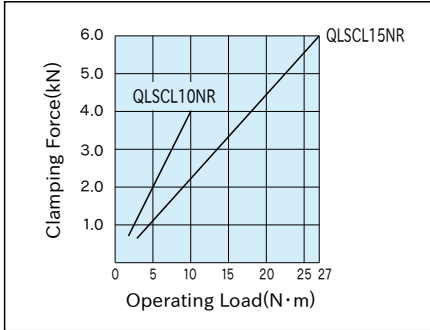

Note

Ensure that mounting surfaces are finished to $\sqrt{6.3}$ (6.3a) or better, without any scratches or dents.

QLSCL-R

LOW-PROFILE CAM EDGE CLAMPS



One-Touch type is available.

CP133

COMPACT TOE CLAMPS

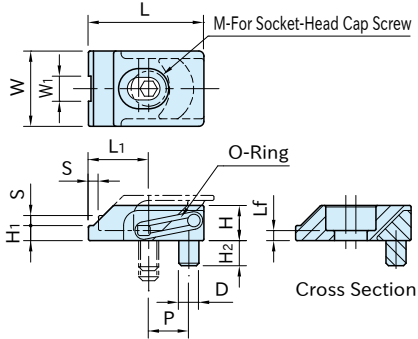

Body	O-Ring
SCM440 steel Black oxide finished HRC33-39	Fluoro rubber

Part Number	S	W	W ₁	H ₁	L ₁	P	D	H ₂	M	L _f	L	H
CP133-04007	2	15	5	3	12	8	4	5	M4	2	23	7
CP133-05009	2.5	19	7	4	14	10	5	6	M5	3	28	9

Part Number	Clamping Force (kN)	Allowable Screw Torque (N·m)	Weight (g)	Proper O-ring
CP133-04007	2	2.7	13	SS060(CS1 / ID6)
CP133-05009	3	5.4	27	S 8 (CS1.5 / ID7.5)

How To Use

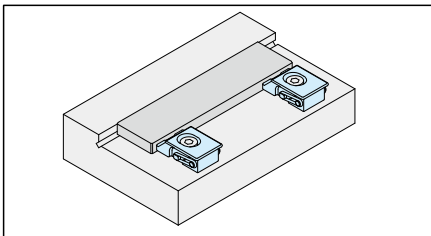

Feature

(Jaw moves obliquely downward)

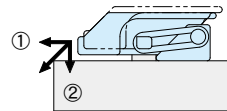

- ① Horizontal pressure against workpiece
- ② Vertical pressure preventing workpiece lift

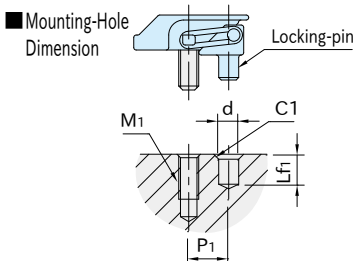

Drill a tapped hole and a locking-pin hole as specified below.

Part Number	M ₁	d (+0.3 / 0)	L _{f1}	P ₁
CP133-04007	M4	4	6	8
CP133-05009	M5	5	7	10

CP134

COMPACT SIDE CLAMPS

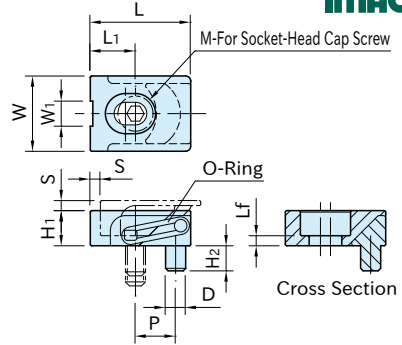

Body	O-Ring
SCM440 steel Black oxide finished HRC33-39	Fluoro rubber

Part Number	S	W	W _i	H ₁	L ₁	P	D	H ₂	M	L _f	L
CP134-04007	2	15	5	7	9	8	4	5	M4	2	20
CP134-05009	2.5	19	7	9	11	10	5	6	M5	3	25

Part Number	Clamping Force (kN)	Allowable Screw Torque (N·m)	Weight (g)	Proper O-ring
CP134-04007	2.5	2.7	13	SS060(CS1 / ID6)
CP134-05009	3.5	5.4	26	S 8 (CS1.5 / ID7.5)

How To Use

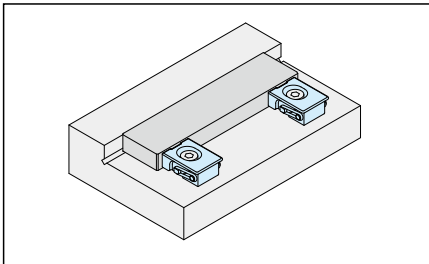

Feature

(Jaw moves obliquely downward)

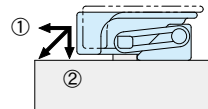

- ① Horizontal pressure against workpiece
- ② Vertical pressure preventing workpiece lift

Mounting-Hole Dimension

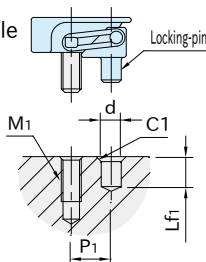

Drill a tapped hole and a locking-pin hole as specified below.

Part Number	M ₁	d _(+0.3/0)	L _{f1}	P ₁
CP134-04007	M4	4	6	8
CP134-05009	M5	5	7	10

CP106

TOE CLAMPS

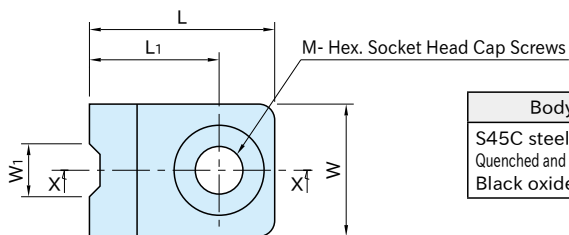

Body
S45C steel
Quenched and tempered
Black oxide finish

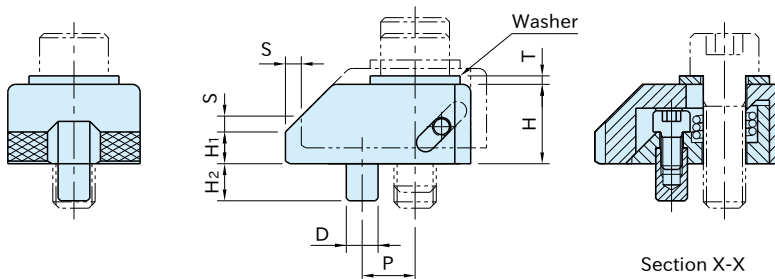

Part Number	S	W	W ₁	H ₁	L ₁	P	D (h7)	H ₂	M	L	H	T	Clamping Force(kN)	Allowable Screw Torque(N·m)	Weight (g)	
CP106-08015	3	25	10	6	24.5	10	6	7	M 8	8	35	15	1.6	5.6	20	100
CP106-10019	4	30	11	8	29	12			M10	43	19	2	6.8	40	185	
CP106-12023	5	35	12	9	37	16	10	10	M12	54	23	2.3	16	70	320	
CP106-16025	6	40	14	10	45	20			M16	65	25	3.2	22	110	520	

How To Use

Mounting-Hole Dimension

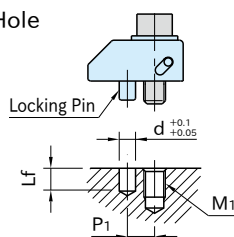

Part Number	M ₁	d	L _f	P ₁
CP106-08015	M 8	6	8	10
CP106-10019	M10		12	
CP106-12023	M12	8	11	16
CP106-16025	M16	10		20

Drill a tapped hole and a pin hole as specified on the above.

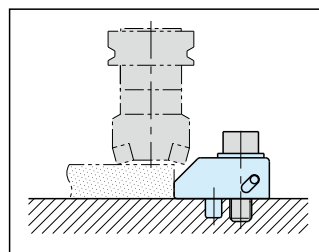

Supplied With

One flat washer

CP107

SIDE CLAMPS

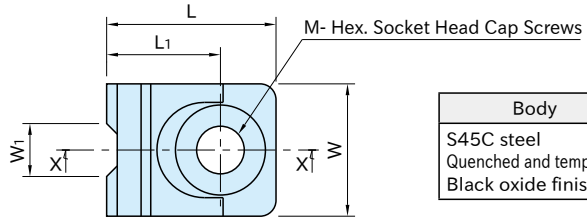

Body
S45C steel Quenched and tempered Black oxide finish

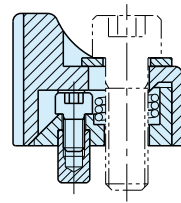
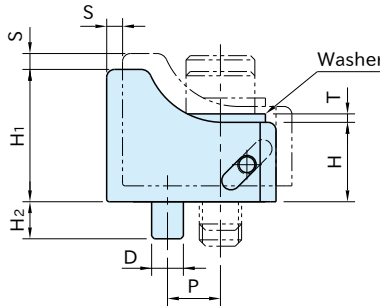
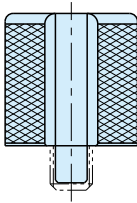

Section X-X

Part Number	S	W	W ₁	H ₁	L ₁	P	D (h7)	H ₂	M	L	H	T	Clamping Force(kN)	Allowable Screw Torque(N·m)	Weight (g)
CP107-08015	3	25	10	25	21.5	10	6	7	M 8	32	15	1.6	5.6	20	115
CP107-10019	4	30	11	32	26	12		7	M10	40	19	2	6.8	40	225
CP107-12023	5	35	12	38	33	16	10	10	M12	50	23	2.3	16	70	390
CP107-16025	6	40	14	45	40	20		10	M16	60	25	3.2	22	110	640

How To Use

Mounting-Hole Dimension

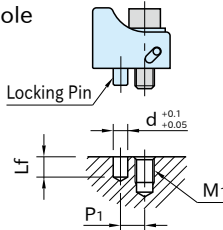

Part Number	M ₁	d	L _f	P ₁
CP107-08015	M 8	6	8	10
CP107-10019	M10		12	
CP107-12023	M12	8	11	16
CP107-16025	M16	10		20

Drill a tapped hole and a pin hole as specified on the above.

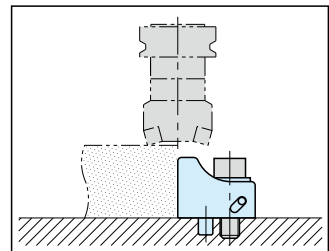

Supplied With

One flat washer

CP104

TOE CLAMPS



Serrated Nose



Smooth Nose

Body	Sliding Nose
SCM440 steel Quenched and tempered Black oxide finish	SCM440 steel Induction hardened (clamping face) Black oxide finish Precision ground (smooth nose)

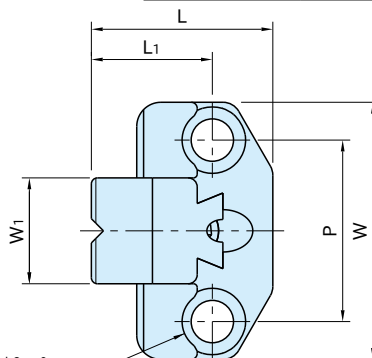

M-For Hex. Socket Head Cap Screws

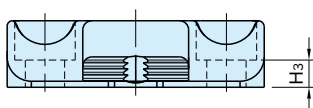

Serrated Nose

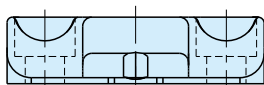
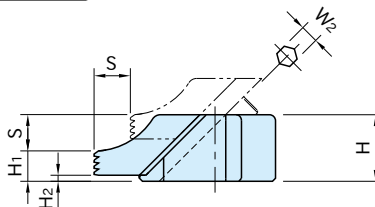

Smooth Nose

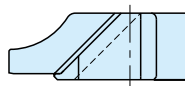

Nose	Part Number	S	W ₁	H ₁	H ₂	L ₁	W	L	M	H ₃	P	H	W ₂	Clamping Force(kN)	Allowable Screw Torque(N·m)	Weight (g)
Serrated	CP104-08016	7	25	7.5	1.5	25	65	39.5	M 8	7	45	16	4	4	8	160
	CP104-12022	12	35	10	2	40	85	60	M12	9	60	22	6	9	26	450
	CP104-16030	14	40	14		50	100	77	M16	13	70	30	8	17	60	900
Smooth	CP104-08116	7	25	7.5	1.5	25	65	39.5	M 8	7	45	16	4	4	8	160
	CP104-12122	12	35	10	2	40	85	60	M12	9	60	22	6	9	26	450
	CP104-16130	14	40	14		50	100	77	M16	13	70	30	8	17	60	900

Related Product

BJ101-02 Clamping Screws

CP105

SIDE CLAMPS



Serrated Nose



Smooth Nose

Body/Sliding Nose	Jaw
SCM440 steel Quenched and tempered Black oxide finish	SCM440 steel Quenched and tempered Black oxide finish Precision ground (smooth nose)

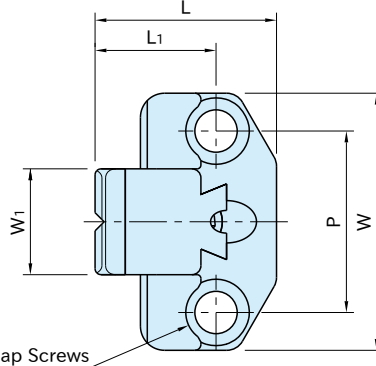

M-For Hex. Socket Head Cap Screws

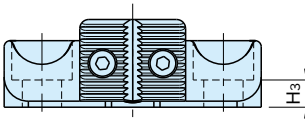

Serrated Jaw

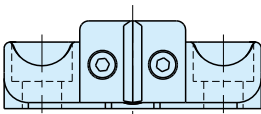
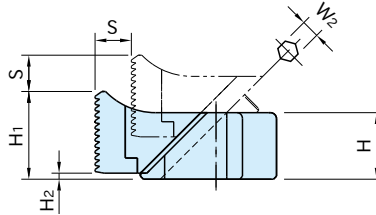

Smooth Jaw

Nose	Part Number	S	W ₁	H ₁	H ₂	L ₁	W	L	M	H ₃	P	H	W ₂	Clamping Force(kN)	Allowable Screw Torque(N·m)	Weight (g)
Serrated	CP105-08016	7	25	19.5	1.5	25	65	39.5	M 8	7	45	16	4	4	8	180
	CP105-12022	12	35	29	2	40	85	60	M12	9	60	22	6	9	26	500
	CP105-16030	14	40	38		50	100	77	M16	13	70	30	8	17	60	1010
Smooth	CP105-08116	7	25	19.5	1.5	25	65	39.5	M 8	7	45	16	4	4	8	180
	CP105-12122	12	35	29	2	40	85	60	M12	9	60	22	6	9	26	510
	CP105-16130	14	40	38		50	100	77	M16	13	70	30	8	17	60	1020

Related Product

BJ101-02 Clamping Screws

QLSCH-H

SIDE CLAMPS



★Key Point

Compact free vise that prevents lifting up of the part.

Body	Jaw	Shaft	Screw
S45C steel Black oxide finished	S45C steel Quenched & tempered Black oxide finished Precision ground	SCM440 steel Black oxide finished	SCM435 steel Quenched & tempered Black oxide finished

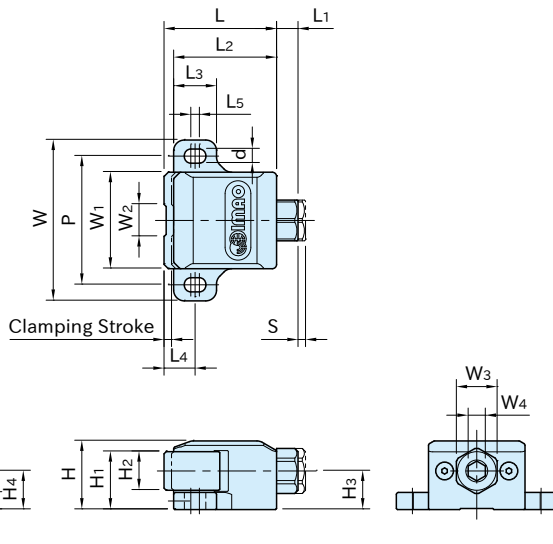

M1 Hex-Socket Setscrew

Part Number	Clamping Stroke	W ₁	W ₂	H ₁	H ₂	M	P ₁	H ₄	L ₄	W	L ₃	H ₅	d	L ₅
QLSCH32H	3	45	15	27	18	M4×0.7 Depth 6	30	18	14	75	20	8	6.6	3
QLSCH40H	4	60	20	33	22	M5×0.8 Depth 8	40	22	19	100	26	10	8.6	4

Part Number	P	H	L	L ₂	L ₁	H ₃	S	W ₃	W ₄	M ₁	Allowable Screw Torque(N·m)	Clamping Force(kN)	Weight (g)
QLSCH32H	60	32	52	48	10	18	3	19	8	M4×0.7-6L	25	9	560
QLSCH40H	80	40	69	63	13	22	4	24	10	M5×0.8-8L	50	14	1240

Feature

- A screw type clamping mechanism provides long clamping stroke and firm clamping.
- Precision-ground jaw is perfect for clamping the workpiece on its finished surface.
- In clamping, the jaw provides downward force to prevent part lift.

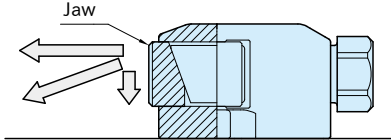

Performance Curve

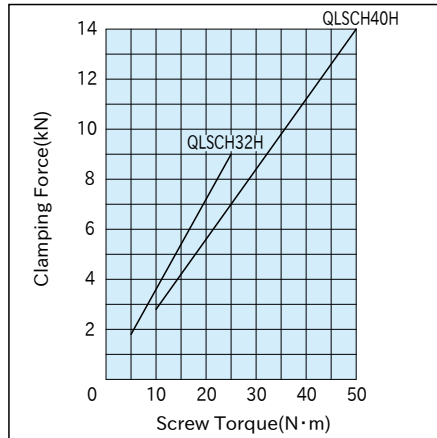

How To Use

- Can be clamped with both of hex wrench and open-end wrench.

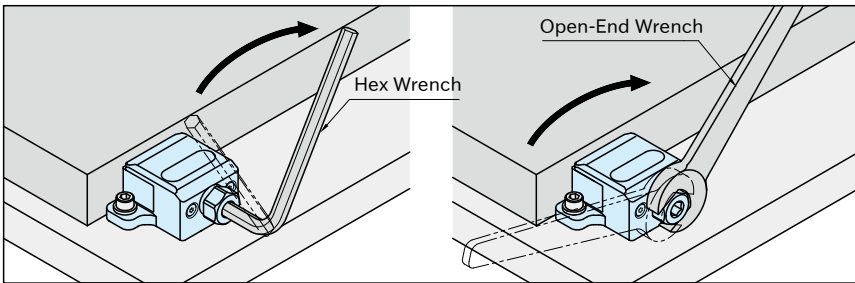

- The locking screw must be screwed onto the hex socket-head cap screw to prevent the body sliding backwards when clamping.

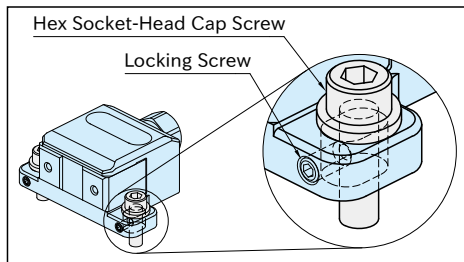

QLSCH

CAM EDGE CLAMPS



One-Touch type is available.

CP100

SIDE CLAMPS



Body / Arm	Jaw	Support Screw
S45C steel Quenched and tempered Black oxide finish	SKH51 steel Quenched and tempered Black oxide finish	S45C steel Induction hardened (Ball head part)

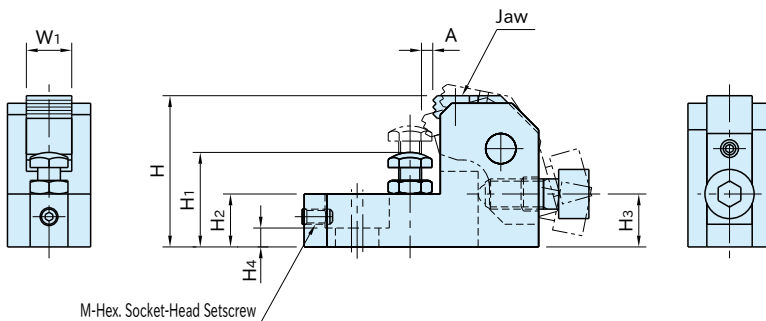
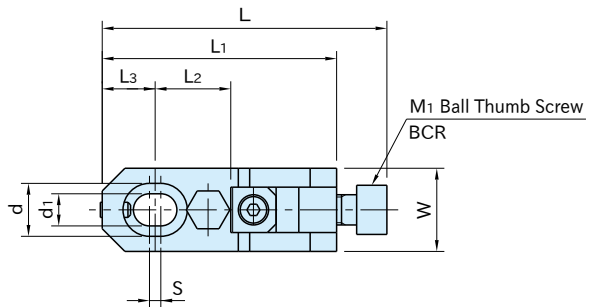

Part Number	A	W ₁	L ₂	L ₃	H	H ₁	W	L	L ₁	d ₁	d	S	H ₂	H ₄
CP100-08040	3	12	20	14	40	25~32	22	75.5	62	8.5	14	3	14	5
CP100-10050	3.7	16	25	18	50	32~40	25	95	78	11	17.5	4	18	7
CP100-12060	4.5	20	30	21	60	40~48	32	113	93	13	20	5	21	8
CP100-16080	6	25	40	28	80	50~65	38	151	124	17	26	6	27	10

Part Number	M	M ₁	H ₃	Clamping Force(kN)	Allowable Screw Torque(N·m)	Weight (kg)	Proper Jaws
CP100-08040	M4×0.7 - 8L	M 8×1.25-20L	14	9	15	0.23	HSE-9126-SS
CP100-10050	M5×0.8 -10L	M10×1.5 -25L	17.5	15	30	0.41	HSE-9166-SS
CP100-12060	M6×1 -12L	M12×1.75-30L	21	25	65	0.75	HSE-9200-SS
CP100-16080	M8×1.25-16L	M16×2 -40L	28	38	100	1.57	HSE-9250-SS

How To Use

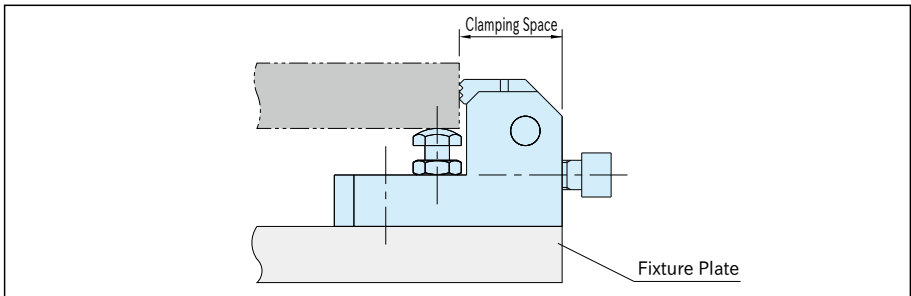

Smaller clamping space allows clamping a larger workpiece.

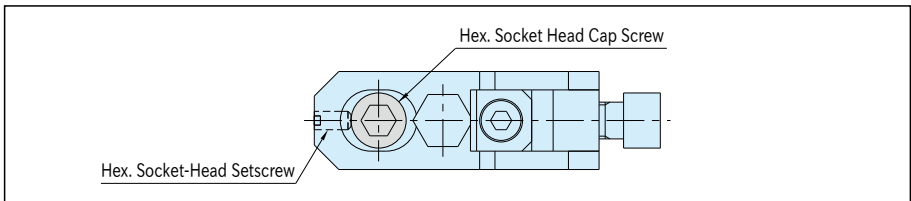

The hex. socket-head setscrew works to prevent the clamp from sliding back if screwed in until it contacts the cap screw.

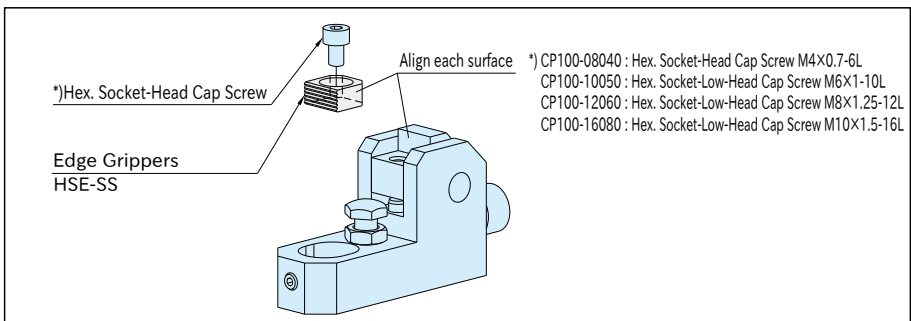

Jaw is replaceable.

For installing, use a hex.socket-head cap screw. Fit the jaw onto a pocket of the side clamp arm.

CP101

SIDE CLAMPS



Body	Arm	Jaw
S45C steel Black oxide finish	S45C steel Quenched and tempered Black oxide finish	SKH51 steel Quenched and tempered Black oxide finish

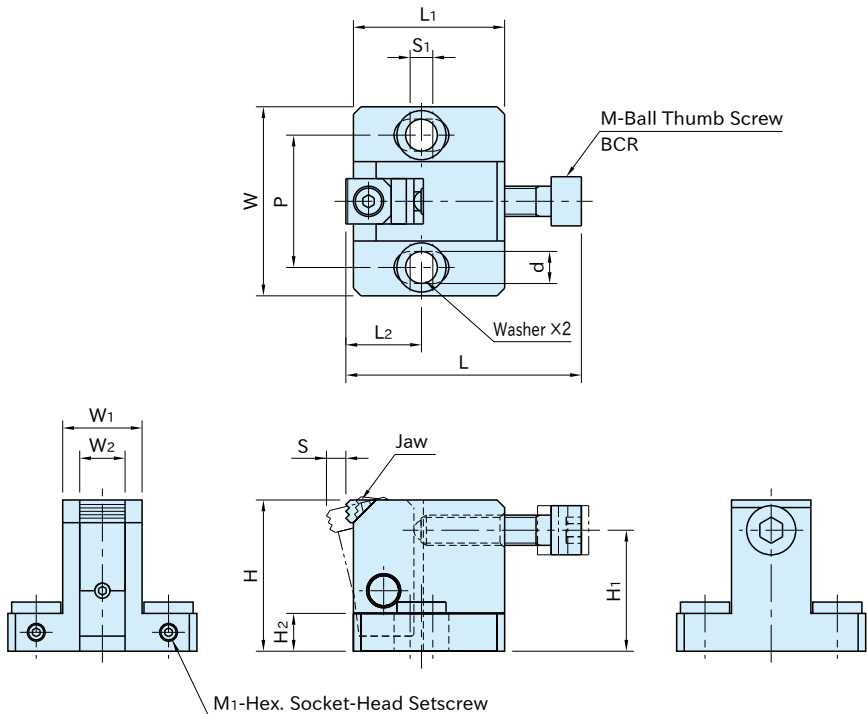

Part Number	S	W ₂	L ₂	H	W	L	W ₁	L ₁	d	S ₁	H ₂	P	M ₁
CP101-08040	5.3	12	20	40	50	62.5	21	40	8.5	6	10	35	M4×0.7-10L
CP101-10050	7.1	16	25	50	65	74	27	50	11	8	12	45	M4×0.7-12L
CP101-12060	8	20	30	60	70	91	31	60	13	10	15	50	M5×0.8-15L
CP101-16080	10.2	25	40	80	90	115	39	80	17	15	20	65	M6×1 -20L

Part Number	M	H ₁	Clamping Force(kN)	Allowable Screw Torque(N·m)	Weight (kg)	Proper Jaws
CP101-08040	M 8×1.25-35L	32	15	25	0.33	HSE-9126-SS
CP101-10050	M10×1.5 -40L	40	27	50	0.66	HSE-9166-SS
CP101-12060	M12×1.75-50L	48	38	90	1.06	HSE-9200-SS
CP101-16080	M16×2 -60L	64	46	130	2.38	HSE-9250-SS

How To Use

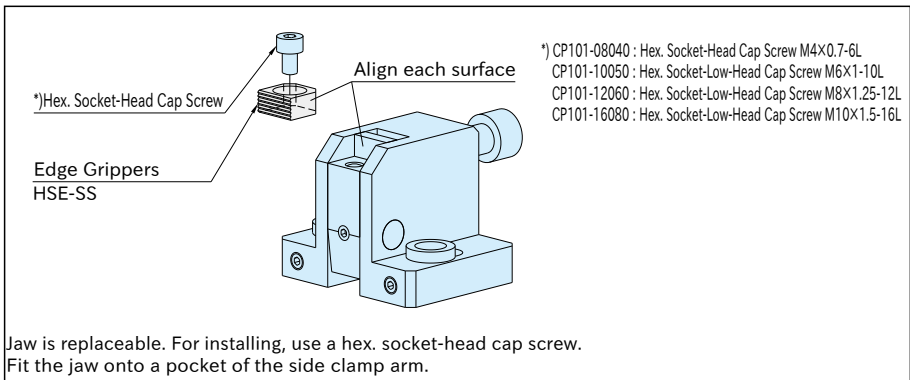
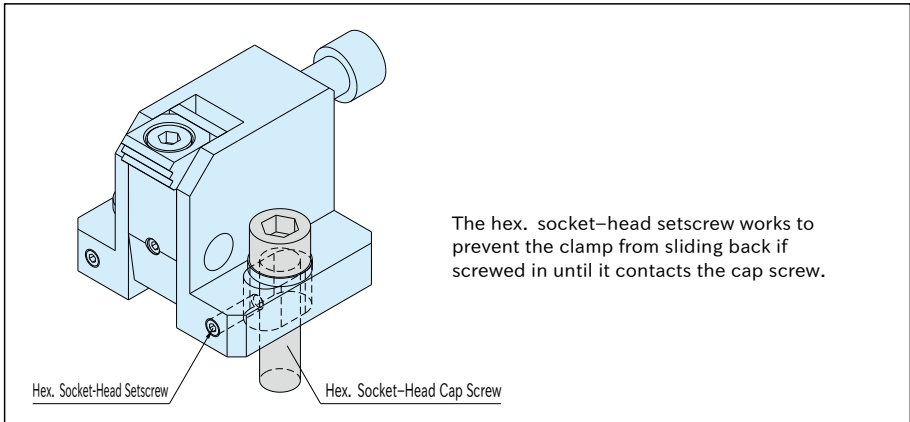

Supplied With

Two flat washers

CP102

WIDE-JAW SIDE CLAMPS



Body	Arm	Jaw
S45C steel Black oxide finish	S45C steel Quenched and tempered Black oxide finish	SKH51 steel Quenched and tempered Black oxide finish

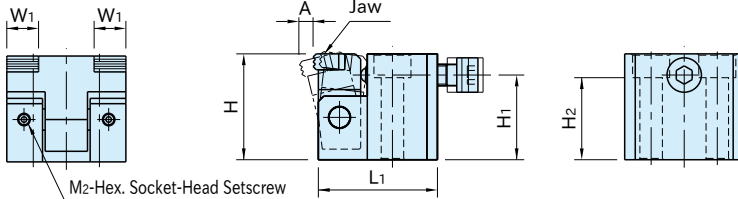
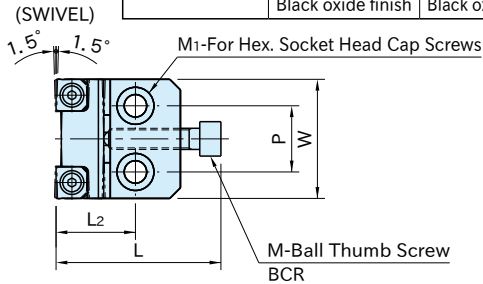

Part Number	A	W ₁	L ₂	H	W	L	L ₁	M ₁	H ₂	P	M ₂	M	H ₁	Clamping Force(kN)
CP102-08040	5.3	12	30	40	45	62.5	45	M 8	31	25	M4x0.7-4L	M 8X1.25-35L	32	15
CP102-10050	7.1	16	40	50	55	74	55	M10	39	30		M10X1.5 -40L	40	27
CP102-12060	8	20	45	60	65	91	65	M12	47	35		M5x0.8-5L	M12X1.75-50L	48

Part Number	Allowable Screw Torque (N·m)	Weight (kg)	Proper Jaws
CP102-08040	25	0.55	HSE-9126-SS
CP102-10050	50	1	HSE-9166-SS
CP102-12060	90	1.69	HSE-9200-SS

*) Hex. Socket-Head Cap Screw

Edge Grippers HSE-SS

*) CP102-08040 : Hex. Socket-Head Cap Screw M4X0.7-6L
 CP102-10050 : Hex. Socket-Low-Head Cap Screw M6X1-10L
 CP102-12060 : Hex. Socket-Low-Head Cap Screw M8X1.25-12L

How To Use

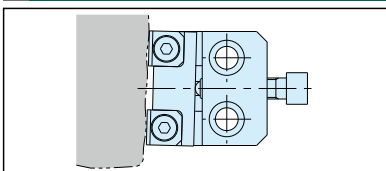

The jaw swivels to fit an unmachined surface of the workpiece.

Jaw is replaceable. For installing, use a hex. socket-head cap screw. Fit the jaw onto a pocket of the side clamp arm.

CP132

COMPACT WEDGE CLAMPS

CP132-A

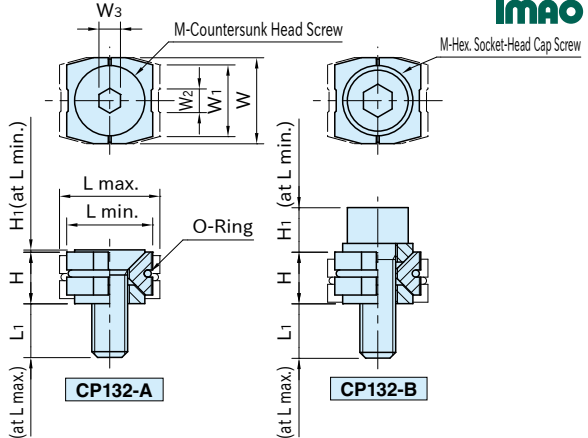
CP132-B

★Key Point

Can clamp 2 workpieces in small space.

Jaw	Washer	O-Ring
SNCM439 steel Black oxide finished HRC33-39	SCM435 steel Black oxide finished	Fluoro rubber

Part Number	L		W	H		W ₁	W ₂	H ₁	M	L ₁	W ₃
	min.	max.		L min.	L max.						
CP132-05001A	12	14	12	7.2	6.2	10	3.3	0.3	M5×0.8 -15L	9.5	3
CP132-06001A	15	17	14.8	8.5	7.5	12	4	0.2	M6×1 -16L	9.3	4
CP132-08001A	18.5	21.5	18.4	11.4	9.9	16	5.3	0.4	M8×1.25-20L	11.3	5
CP132-05001B	12	14	12	7.2	6.2	10	3.3	6.2	M5×0.8 -16L	9.6	4
CP132-06001B	15	17	14.8	8.5	7.5	12	4	7.3	M6×1 -18L	10.2	5
CP132-08001B	18.5	21.5	18.4	11.4	9.9	16	5.3	9.8	M8×1.25-25L	14.9	6

Part Number	Clamping Force (kN)	Allowable Screw Torque (N·m)	Weight (g)	Proper O-ring
CP132-05001A	2	4.3	8	SS080(CS1 / ID 8)
CP132-06001A	3.5	7.3	13	S 12 (CS1.5 / ID11.5)
CP132-08001A	5	18	27	S 14 (CS1.5 / ID13.5)
CP132-05001B	3	5.4	9	SS080(CS1 / ID 8)
CP132-06001B	4.5	9.1	17	S 12 (CS1.5 / ID11.5)
CP132-08001B	9	22	30	S 14 (CS1.5 / ID13.5)

Feature

- The wedge construction allows powerfully clamping the workpiece.
- Can hold two workpieces with equilateral clamping action by using a hex wrench.

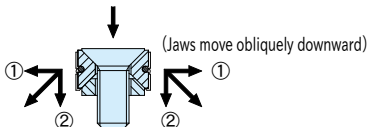

- ① Horizontal pressure against workpiece
- ② Vertical pressure preventing workpiece lift

How To Use

Compact design allows to utilize machining area and clamp multiple workpieces.

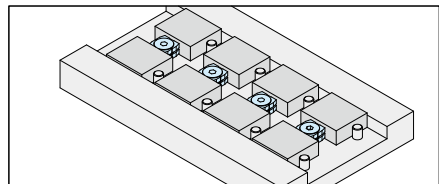

QLSWC

SWING CLAMPS FOR TORQUE CONTROL



Base/Washer/Flange Nut/Clamping Spindle	Body
S45C steel Quenched and tempered Black oxide finish	SCM440 steel Quenched and tempered Black oxide finish

Feature

- Designed for clamping-force control with a torque wrench.
- Screw-locking mechanism allows for longer clamping stroke and greater clamping force than a cam-locking mechanism.

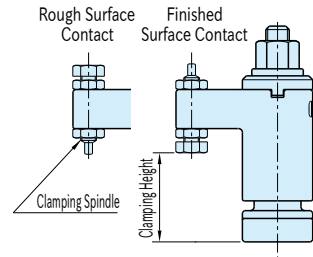
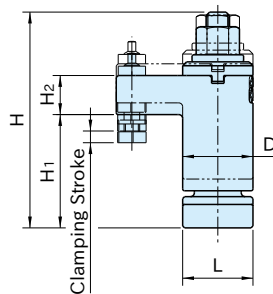
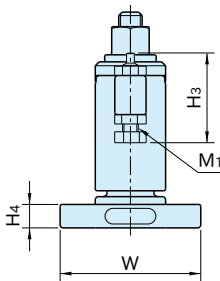
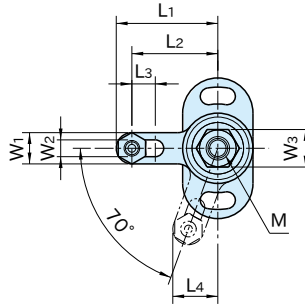
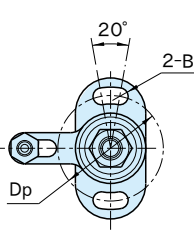

Part Number	Clamping Height *)				Clamping Stroke	L ₂	L ₃	L ₁	L ₄	W	L	H ₄	B	Dp
	Finished Surface Contact		Rough Surface Contact											
	Min.	Max.	Min.	Max.										
QLSWC-0618	21.8 (21.8~24.8)	23.8 (23.8~26.8)	21.4 (21.4~24.4)	23.4 (23.4~26.4)	3	22	6	26	11.5	36	18	6	4.3	27
QLSWC-0823	30.3 (30.3~34.3)	32.3 (32.3~36.3)	31.2 (31.2~35.2)	33.2 (33.2~37.2)	4	30	8	35	15.3	45	23	8	5.3	34
QLSWC-1030	30.5 (30.5~34.5)	37 (37~41)	31.5 (31.5~35.5)	38 (38~42)										
QLSWC-1240	34.5 (34.5~39.5)	44 (44~49)	37 (37~42)	46.5 (46.5~51.5)	5	45		55	25.4	85	40	15	10.5	64

*) Clamping height can be adjusted. The parenthesised values denote clamping height range.

Part Number	H	D	W ₁	W ₂	H ₂	H ₁	M ₁	H ₃	W ₃	M	Clamping Force(kN)	Allowable Screw Torque(N·m)	Weight (g)
QLSWC-0618	56.5	18	8	4.3	10	29	M 4×0.7	22.8	10	M 6×1	2.3	6	94
QLSWC-0823	73.5	23	10	5.3	14	39	M 5×0.8	28.5	13	M 8×1.25	3.6	10.5	210
QLSWC-1030	91	30	16	8.4	18	48	M 8×1.25	45.5	17	M10×1.5	6	30	515
QLSWC-1240	114	40	20	10.4	22	58	M10×1.5	57	19	M12×1.75	7.5	45	1100

How To Use

How to Operate

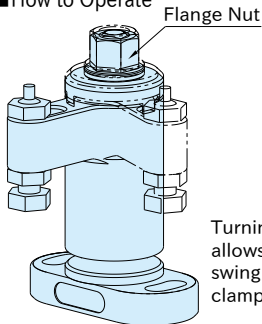

Turning the flange nut allows the clamp arm to swing into position for clamping.

Performance Curve

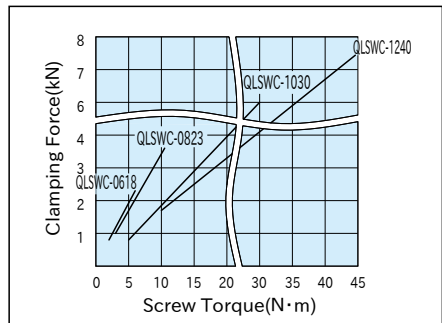

Note

Do not use a power tool (impact wrench etc.) to turn the flange nut, for damage prevention.

QLSWC

SWING CLAMPS WITH ADJUSTABLE HANDLE



One-Touch type is available.

PTSW1

SWING CLAMPS (Quick-Acting)



Without Clamp Arm

Body / Clamp-Arm Holder / Hex. Head	Clamp Arm
SCM440 steel Quenched and tempered Black oxide finish	S45C steel Quenched and tempered Black oxide finish

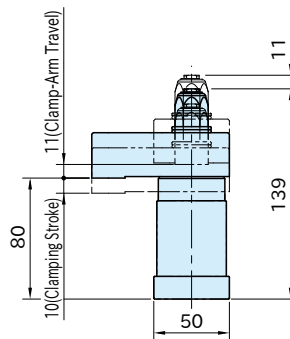
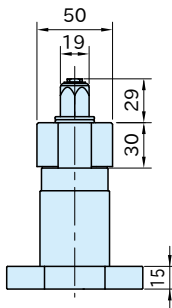
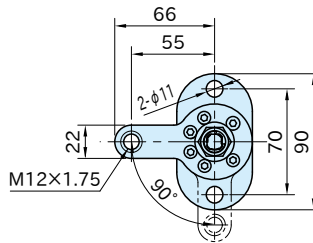

Feature

- The clamp arm swings in swift response to the turning speed of an impact wrench, for quick clamping.
- A short clamp-arm travel allows quick clamping.

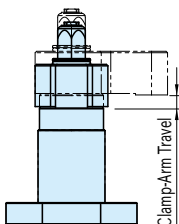

Note: For robotized production lines, use Spiral-Acting Swing Clamps.

■ With Clamp Arm

Part Number	Clamping Force(kN)	Allowable Screw Torque (N·m)	Clamping Direction	Weight (kg)
PTSW1-12R	6	28	CW	1.6

■ Without Clamp Arm

Part Number	Clamping Force(kN)	Allowable Screw Torque (N·m)	Clamping Direction	Weight (kg)
PTSW1-12NR	6	28	CW	1.2

Note: If you prepare a custom clamp arm, contact us for the dimensional information on its mounting section.
Note that custom clamp arms made by yourselves may cause clamping force to be increased or decreased.



How To Use

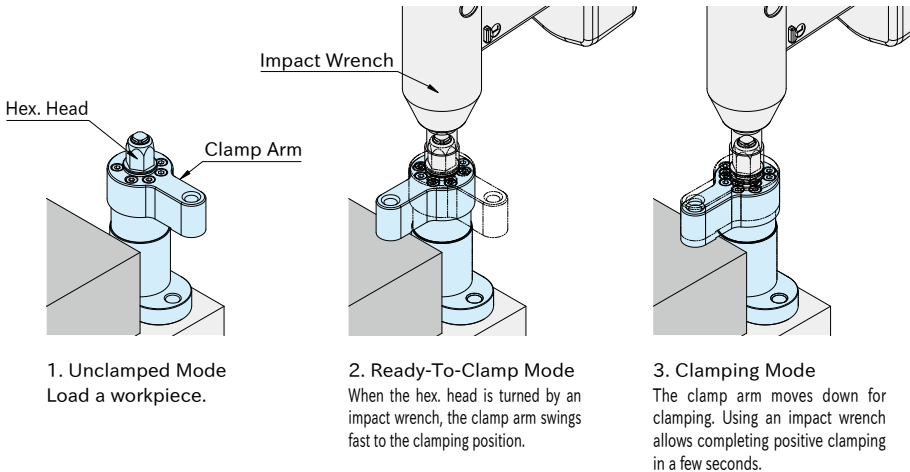

Note

- Do not use applying higher torque than allowable for a long period of time, to avoid damage. Using a torque-settable impact wrench is recommended.
- Use **PTSW2** in robotized production lines.

PTSW2

SWING CLAMPS (Spiral-Acting)



Without Clamp Arm

Body / Clamp-Arm Holder / Hex. Head	Clamp Arm
SCM440 steel Quenched and tempered Black oxide finish	S45C steel Quenched and tempered Black oxide finish

Counterclockwise Clamping

Clockwise Clamping

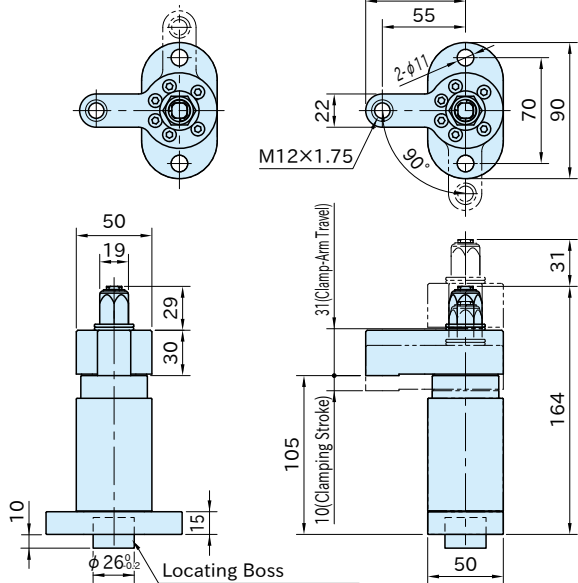

Note: Use when locating clamps is required in the robotized production line.

Feature

The inside spiral groove allows the clamp arm to swing positively.

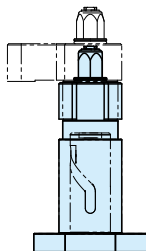

■ With Clamp Arm

Part Number	Clamping Force (kN)	Allowable Screw Torque (N·m)	Clamping Direction	Weight (kg)
PTSW2-12R	6	28	CW	2
PTSW2-12L			CCW	

■ Without Clamp Arm

Part Number	Clamping Force (kN)	Allowable Screw Torque (N·m)	Clamping Direction	Weight (kg)
PTSW2-12NR	6	28	CW	1.6
PTSW2-12NL			CCW	

Note: If you prepare a custom clamp arm, contact us for the dimensional information on its mounting section. Note that custom clamp arms made by yourselves may cause clamping force to be increased or decreased.



How To Use

Hex. Head

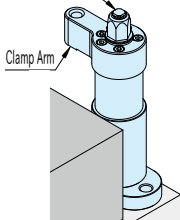

1. Unclamped Mode
Load or unload a workpiece.

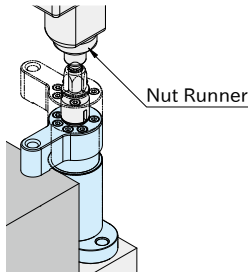

2. Ready-To-Clamp Mode
When the hex. head is turned by a nut runner, the clamp arm swings fast to the clamping position.

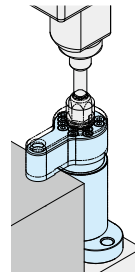

3. Clamping Mode
The clamp arm moves down for clamping. Using a nut runner allows completing positive clamping in a few seconds.

Note

A torque-settable impact wrench may also be used to operate these clamps.

PTPD

BLOCK PULL CLAMPS



Body	Contact Pad	Locating Bushing
S45C steel Black oxide finish	SCM440 steel Quenched and tempered Black oxide finish	SCM435 steel Quenched and tempered Black oxide finish

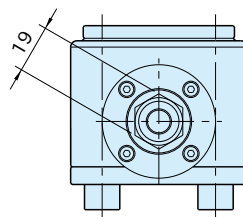
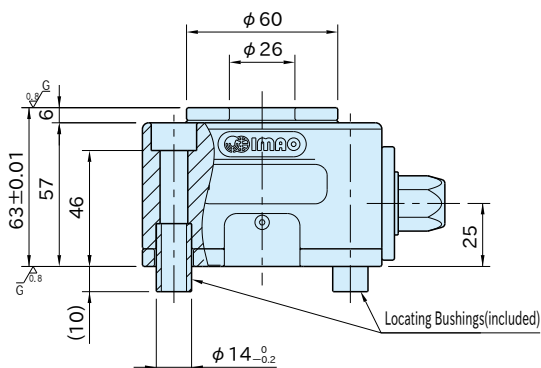
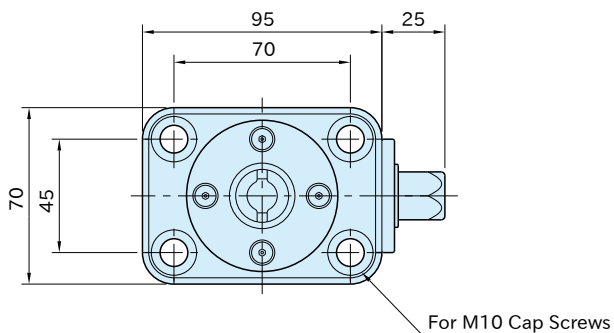

Part Number	Weight (kg)
PTPD12	2.3

Options of Operating Tool	Clamping Force (kN)	Allowable Screw Torque (N·m)
Spanner or Socket Wrench	12	40
Nut Runner (for robotization)		
Impact Wrench	6	20

Note

Do not use applying a greater torque than allowable for a long period of time, to avoid damage. When an impact wrench is used, the torque-settable type is recommended.

Related Product

PTPD-M Clamping Screws

Feature

Clamp the workpiece from bottom.

■ Ideal for 5-Axis Machining

Block Pull Clamps mount under a workpiece making its surfaces to be machined fully open for the cutting tool. This allows completing multiple machining processes at a time.

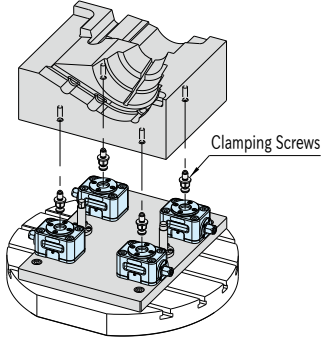

■ Better Workability

Block Pull Clamps allow fastening a workpiece easily, unlike the conventional method of fastening with hexagon head screws from below.

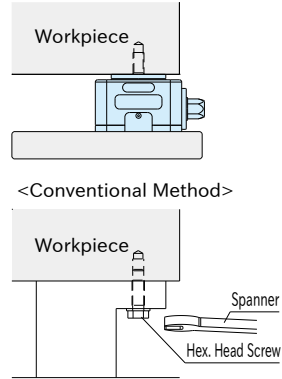

How To Use

In addition to tightening with wrench, this clamp can be operated with nut runner for automation and impact wrench for lower workload.

■ Spacing Between Two Clamping-Screw Holes

Locating repeatability in using Block Pull Clamps alone is ± 0.3 .

Note: Install locating pins for better accuracy, as shown above.

*) To remove metal chips in the mechanism, take off the side covers and blow air from above.

PTPD-M

CLAMPING SCREWS for BLOCK PULL CLAMPS

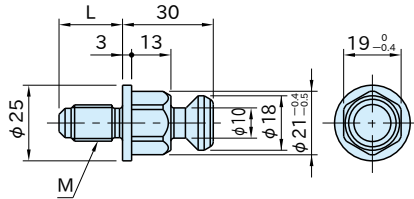

Body

SCM435 steel
Quenched and tempered
Black oxide finish

Part Number	M	L	Weight (g)	Proper Block Pull Clamp
PTPD12-M10	M10×1.5	18	69	PTPD12
PTPD12-M12	M12×1.75	21	75	
PTPD12-M16	M16×2	28	98	

BJ132

HOOK CLAMPS

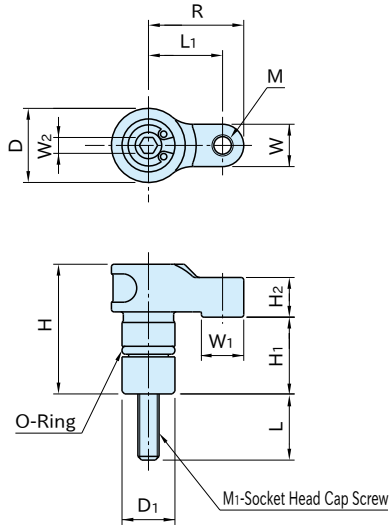

Body
SCM440 steel
Quenched and tempered
Black oxide

Part Number	W ₁	M	L ₁	R	D ₁ (^{-0.021} / _{-0.10})	H ₁	M ₁	L	H	D	W	H ₂	W ₂
BJ132-04018	8	M4×0.7	14	18	10	14.5	M4×0.7-30L	12.5	24.5	14	8	7.5	3
BJ132-06022	10	M5×0.8	17	22	12	17.5	M6×1 -35L	13.5	30.5	16	10	9.5	5

Part Number	Clamping Force (kN)	Allowable Screw Torque (N·m)	Weight (g)
BJ132-04018	2	2.7	25
BJ132-06022	3.5	7	45

Feature

- Compact design for applications in limited space
- **BJ530** Hook-Clamp Holders are available.
- Clamp that is designed to move up and down in conjunction with the tightening screw, for prevention of galling.

How To Use

Instead of being used with Hook-Clamp Holders, these Hook Clamps can be plugged into a custom block with receiving holes as specified on the right.

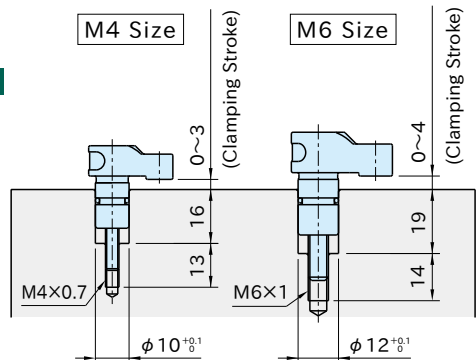
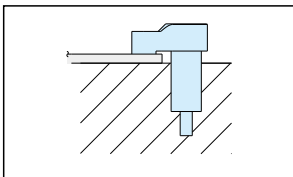

BJ132-A

HOOK-CLAMP ASSEMBLIES

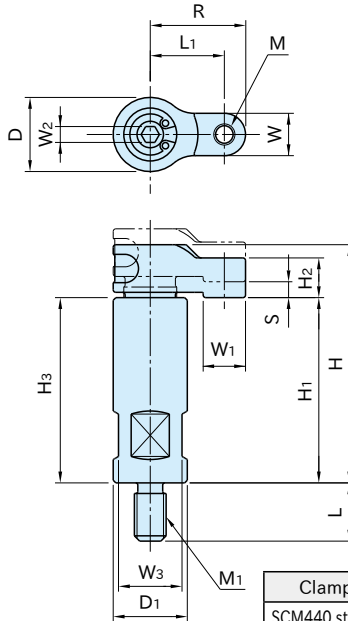

Clamp Body	Holder
SCM440 steel Quenched and tempered Black oxide finished	S45C steel Quenched and tempered Black oxide finished

Part Number	H ₁	S (Clamping Stroke)	W ₁	M	L ₁	R	D ₁	H ₃	M ₁	L	H	D	W	H ₂	W ₂	W ₃
BJ132-04018A	35	3	8	M4×0.7	14	18	14	35	M6×1	11	45	14	8	7.5	3	12
BJ132-06022A	40	4	10	M5×0.8	17	22	16	40	M8×1.25	14	53	16	10	9.5	5	13

Part Number	Clamping Force (kN)	Allowable Screw Torque (N·m)	Weight (g)
BJ132-04018A	2	2.7	55
BJ132-06022A	3.5	7	90

Feature

The hook clamp is designed to move up and down in conjunction with the tightening screw, for prevention of galling in the hook-clamp holder.

How To Use

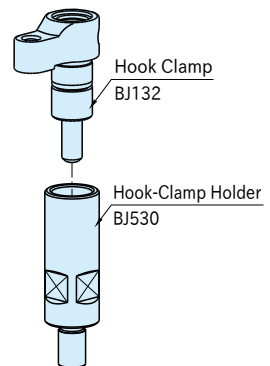
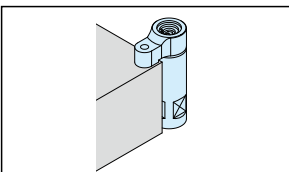

BJ132-B

HOOK-CLAMP ASSEMBLIES WITH FLANGED HOLDER

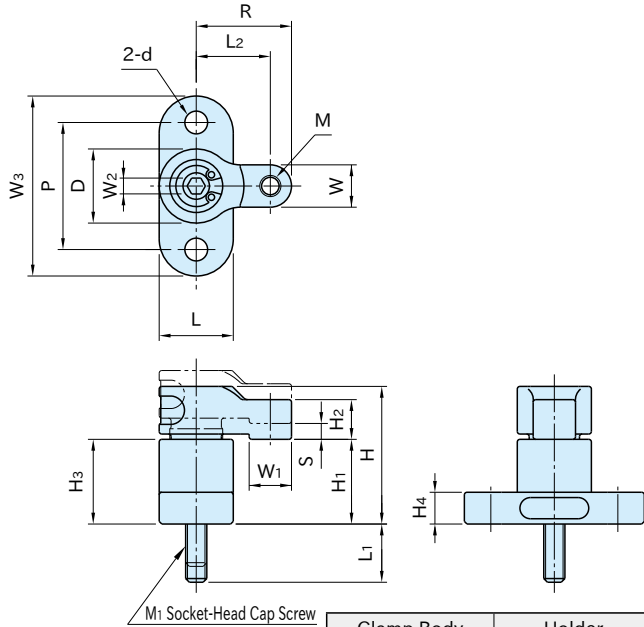

Clamp Body	Holder
SCM440 steel	S45C steel
Quenched and tempered	Quenched and tempered
Black oxide finished	Black oxide finished

Part Number	H ₁	S (Clamping Stroke)	W ₁	M	L ₂	R	W ₃	L	M ₁	L ₁ (max)	d	H ₄	P	H	H ₃	D	W	H ₂	W ₂
BJ132-04018B	16	3	8	M4×0.7	14	18	34	14	M4×0.7-30L	11	4.3	6	24	26	16	14	8	7.5	3
BJ132-06022B	19	4	10	M5×0.8	17	22	40	16	M6×1 -35L	12	5.3	8	28	32	19	16	10	9.5	5

Part Number	Clamping Force (kN)	Allowable Screw Torque (N·m)	Weight (g)
BJ132-04018B	2	2.7	45
BJ132-06022B	3.5	7	75

Feature

- Ideal for low height clamping.
- The hook clamp is designed to move up and down in conjunction with the tightening screw, for prevention of galling in the hook-clamp holder.

Part Number	M ₂	M ₃	P ₂
BJ132-04018B	M4×0.7 Depth 13	M4×0.7	24
BJ132-06022B	M6×1 Depth 14	M5×0.8	28

How To Use

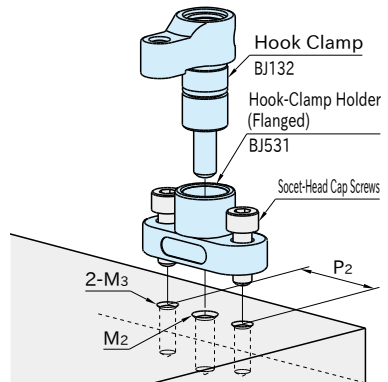

BJ130

HOOK CLAMPS



M8 Size



M10-M16 Sizes

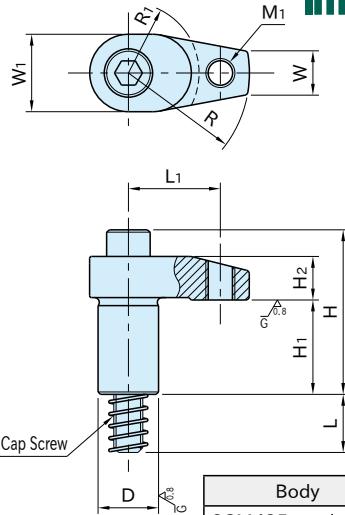

M- Socket-Head Cap Screw

Body
SCM435 steel
Quenched & tempered
Black oxide finished
Precision ground

Related Product

BJ530 Hook-Clamp Holders

How To Use

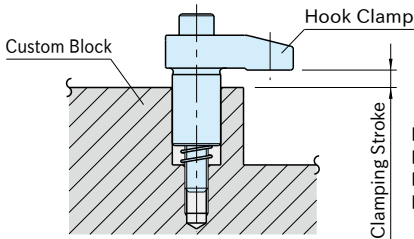

- BJ130-08***(M 8 size) : 10mm
- BJ130-10***(M10 size) : 12mm
- BJ130-12***(M12 size) : 15mm
- BJ130-16***(M16 size) : 15mm

■ Machining Instruction for Custom Blocks

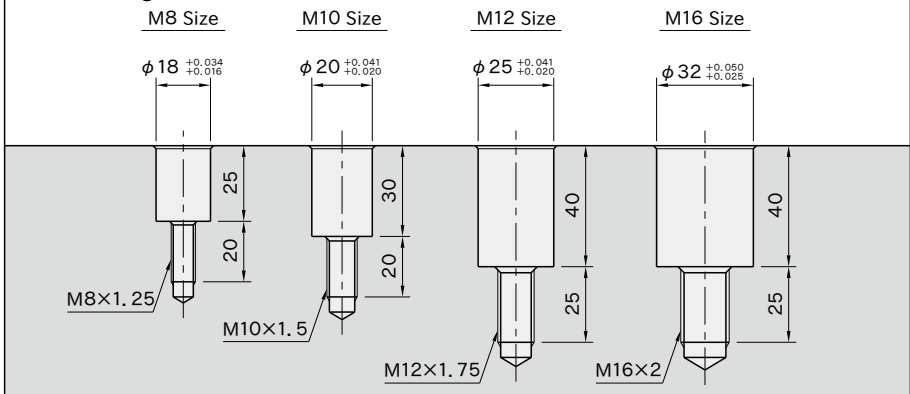

Hook Clamps can be plugged directly into custom blocks with receiving holes as specified above.

Part Number	R	R ₁	M ₁	L ₁	D (h7)	H ₁	M	L	H						
BJ130-08020	20	15	—	—	18	23	M 8×1.25-50L	21	37						
BJ130-08025	25														
BJ130-08030	30														
BJ130-10030	30	20	—	—	20	30	M10×1.5 -65L	21	54						
BJ130-10040	40	25													
BJ130-12040	40	25								—	—	25	39	M12×1.75-80L	26
BJ130-12050	50														
BJ130-12060	60														
BJ130-12140	40		M12×1.75	31	26	66									
BJ130-12150	50			38											
BJ130-12160	60			46			24	68							
BJ130-16040	40			25					—						
BJ130-16050	50														
BJ130-16060	60														
BJ130-16150	50	M12×1.75	38												
BJ130-16160	60		46												

Part Number	W ₁	W	H ₂	Clamping Force(kN)	Allowable Screw Torque(N·m *)	Weight (g)	
BJ130-08020	22	10	12	15	38	90	
BJ130-08025				12	33	100	
BJ130-08030				10	30	105	
BJ130-10030	25	12	15	13	38	165	
BJ130-10040				10	32	180	
BJ130-12040	32	18	16	18	60	305	
BJ130-12050				14	50	360	
BJ130-12060			12	46	380		
BJ130-12140			16	18	60	295	
BJ130-12150				18	14	50	350
BJ130-12160					12	46	370
BJ130-16040			36	22	21	38	170
BJ130-16050	31	150				580	
BJ130-16060	26	130				625	
BJ130-16150	31	150				565	
BJ130-16160	26	130				610	

*) Values for use in conjunction with custom holder blocks.

For use in conjunction with [BJ530](#) Hook-Clamp Holders, apply allowable screw torques given on the [BJ530](#) page.

Note

Please put grease on sliding surface to prevent galling when using in dry condition.

BJ130-A

HOOK-CLAMP ASSEMBLIES



M8 Size



M12 Size

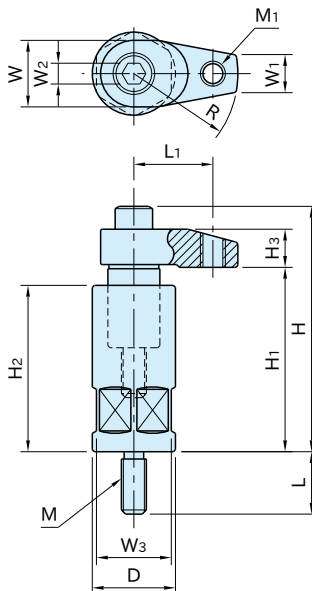

Clamp Body
SCM435 steel
Quenched and tempered
Black oxide finish
Precision ground
Holder
S45C steel
Black oxide finish

Part Number	H ₁	M ₁	L ₁	R	D	H ₂	M	L	H
BJ130-08020A1	55~65	—	—	20	24	55	M 8x1.25	19	69~ 79
BJ130-08025A1				25					
BJ130-08030A1				30					
BJ130-10030A1	63~75	—	—	30	32	63	M12x1.75	30	87~ 99
BJ130-10030A2	80~92					80			104~116
BJ130-10040A1	63~75			63		87~ 99			
BJ130-10040A2	80~92			80		104~116			

Part Number	W	W ₁	H ₃	W ₂	W ₃	Clamping Force(kN)	Allowable Screw Torque(N·m)	Weight (kg)
BJ130-08020A1	22	10	12	6	22	12	30	0.23
BJ130-08025A1						11		0.24
BJ130-08030A1						10		0.25
BJ130-10030A1	25	12	15	8	30	13	38	0.60
BJ130-10030A2						10		0.70
BJ130-10040A1						10	32	0.61
BJ130-10040A2						10		0.71

Related Product

Use [BJ600](#) Cylindrical Risers for additional height.

Note

Please put grease on sliding surface to prevent galling when using in dry condition.

How To Use

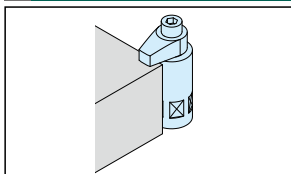

Part Number	H ₁	M ₁	L ₁	R	D	H ₂	M	L	H						
BJ130-12040A1	80~95	—	—	40	40	80	M12x1.75	30	107~122						
BJ130-12040A2	100~115					100			127~142						
BJ130-12050A1	80~95					80			109~124						
BJ130-12050A2	100~115					100			129~144						
BJ130-12060A1	80~95					80			109~124						
BJ130-12060A2	100~115					100			129~144						
BJ130-12140A1	80~95			M12x1.75		31			40	80	107~122				
BJ130-12140A2	100~115									100	127~142				
BJ130-12150A1	80~95									38	50	80	109~124		
BJ130-12150A2	100~115											100	129~144		
BJ130-12160A1	80~95											46	60	80	109~124
BJ130-12160A2	100~115													100	129~144
BJ130-16040A1	80~95	—	—		40	80	M16x2	30	116~131						
BJ130-16040A2	100~115					100			136~151						
BJ130-16050A1	80~95					50			50	80	116~131				
BJ130-16050A2	100~115									100	136~151				
BJ130-16060A1	80~95									60	60	80	116~131		
BJ130-16060A2	100~115											100	136~151		
BJ130-16150A1	80~95			M12x1.75	38							50	80	116~131	
BJ130-16150A2	100~115												100	136~151	
BJ130-16160A1	80~95					46			60				80	116~131	
BJ130-16160A2	100~115												100	136~151	

Part Number	W	W ₁	H ₃	W ₂	W ₃	Clamping Force (kN)	Allowable Screw Torque (N·m)	Weight (kg)				
BJ130-12040A1	32	18	16	10	36	15	50	1.36				
BJ130-12040A2						1.56						
BJ130-12050A1						18		14	1.39			
BJ130-12050A2									1.59			
BJ130-12060A1									12	46	1.43	
BJ130-12060A2											1.63	
BJ130-12140A1			50				50				1.36	
BJ130-12140A2											1.56	
BJ130-12150A1						14		50			1.39	
BJ130-12150A2											1.59	
BJ130-12160A1									12	46	1.43	
BJ130-12160A2											1.63	
BJ130-16040A1	36	22	21	14	46		18				2.11	
BJ130-16040A2							2.42					
BJ130-16050A1						16.5	80	2.16				
BJ130-16050A2								2.47				
BJ130-16060A1								16	80	2.22		
BJ130-16060A2										2.53		
BJ130-16150A1										16.5	80	2.16
BJ130-16150A2												2.47
BJ130-16160A1						16	80					2.22
BJ130-16160A2												2.53

BJ130-B1

HOOK-CLAMP ASSEMBLIES (Flanged)

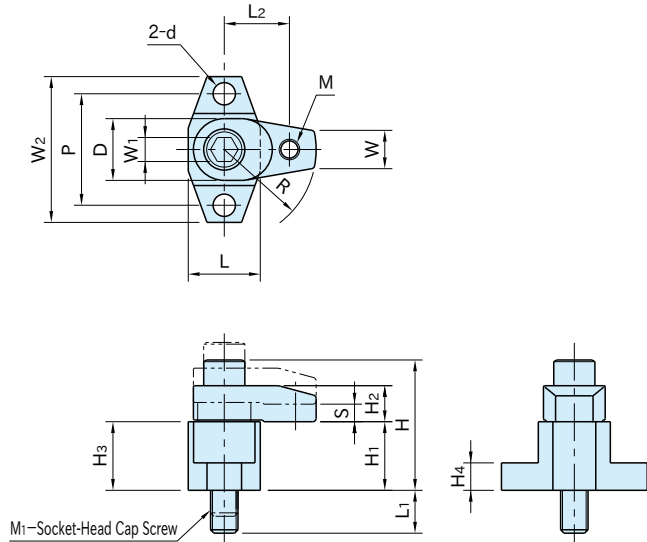

Clamp Body	Holder
SCM435 steel Quenched and tempered Black oxide finish Precision ground	S45C steel Black oxide finish

Part Number	H ₁	S (Clamping Stroke)	M	L ₂	R	W ₂	L	M ₁	L ₁ (max)	d	H ₄	P
BJ130-08020B1	25	10	—	—	20	50	24	M 8×1.25-50L	19	6.6	10	38
25												
30												
BJ130-08030B1	30	12	—	—	30	60	28	M10×1.5 -65L	21	9	12	45
30												
40												

Part Number	H	H ₃	D	W	H ₂	W ₁	Clamping Force(kN)	Allowable Screw Torque(N·m)	Weight (g)
BJ130-08020B1	39	25	22	10	12	6	15	38	175
12							33	185	
10							30	190	
BJ130-10030B1	54	30	25	12	15	8	13	38	315
10							32	330	

Part Number	H ₁	S (Clamping Stroke)	M	L ₂	R	W ₂	L	M ₁	L ₁ (max)	d	H ₄	P		
BJ130-12040B1	40	15	—	—	40	75	35	M12×1.75-80L	25	11	14	55		
BJ130-12050B1					50				23					
BJ130-12060B1					60				25					
BJ130-12140B1					31				40				23	
BJ130-12150B1					38				50					
BJ130-12160B1					46				60					
BJ130-16040B1	40	15	—	—	40	85	42	M16×2 -85L	25	13	16	65		
BJ130-16050B1					50									
BJ130-16060B1					60									
BJ130-16150B1					38								50	
BJ130-16160B1					46								60	

Part Number	H	H ₃	D	W	H ₂	W ₁	Clamping Force(kN)	Allowable Screw Torque(N·m)	Weight (g)
BJ130-12040B1	67	40	32	18	16	10	18	60	595
BJ130-12050B1	69				18		50	650	
BJ130-12060B1	67				16		46	675	
BJ130-12140B1	67				18		60	585	
BJ130-12150B1	69				14		50	640	
BJ130-12160B1	69				12		46	665	
BJ130-16040B1	76	40	36	22	21	14	38	170	930
BJ130-16050B1							31	150	980
BJ130-16060B1							26	130	1025
BJ130-16150B1							31	150	965
BJ130-16160B1							26	130	1010

Feature

Perfect for low-height clamping.

Note

Please put grease on sliding surface to prevent galling when using in dry condition.

How To Use

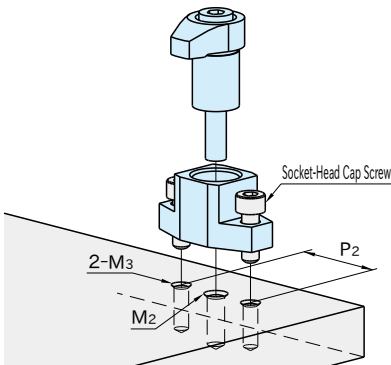

Part Number	M ₂	M ₃	P ₂
BJ130-08020B1	M 8×1.25 Depth 20	M 6×1	38
BJ130-08025B1			
BJ130-08030B1			
BJ130-10030B1	M10×1.5 Depth 21	M 8×1.25	45
BJ130-10040B1			
BJ130-12040B1	M12×1.75 Depth 25	M10×1.5	55
BJ130-12050B1			
BJ130-12060B1			
BJ130-12140B1			
BJ130-12150B1			
BJ130-12160B1			
BJ130-16040B1	M16×2 Depth 25	M12×1.75	65
BJ130-16050B1			
BJ130-16060B1			
BJ130-16150B1			
BJ130-16160B1			

BJ530

HOOK-CLAMP HOLDERS

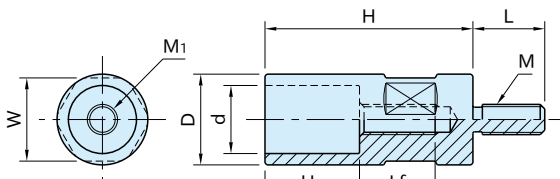

BJ530-04

BJ530-08

BJ530-10

BJ530-06

BJ530-12

BJ530-16

Body
S45C steel
Black oxide finish

Part Number	H	D	d*)	H ₁	M ₁	L _f	M	L	W	Allowable Screw Torque(N·m)	Weight (g)
BJ530-04035	35	14	10	16	M 4×0.7	13	M 6×1	11	12	2.7	30
BJ530-06040	40	16	12	19	M 6×1	14	M 8×1.25	14	13	7	45
BJ530-08055	55	24	18	25	M 8×1.25	20	M 8×1.25	19	22	30	140
BJ530-10063	63	32	20	30	M10×1.5	21	M12×1.75	30	30	38 (32 ^{**})	400
BJ530-10080	80					23					500
BJ530-12080	80	40	25	40	M12×1.75	25	M12×1.75	30	36	50 (46 ^{***})	600
BJ530-12100	100										800
BJ530-16080	80	50	32	40	M16×2	25	M16×2	30	46	80	930
BJ530-16100	100										1230

*) Tolerances of d Diameter

BJ530-04 | BJ530-06 : $^{+0.1}$

BJ530-08 | BJ530-10 | BJ530-12 | BJ530-16 : F7

**) The value to use with BJ130-10040.

***) The value to use with BJ130-12060 or BJ130-12160.

Note

The above screw torque values are effective for installation of BJ130 | BJ132 Hook Clamps.

How To Use

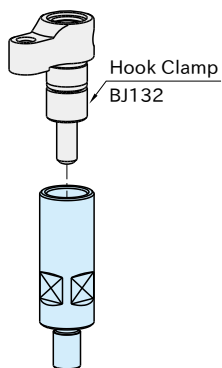
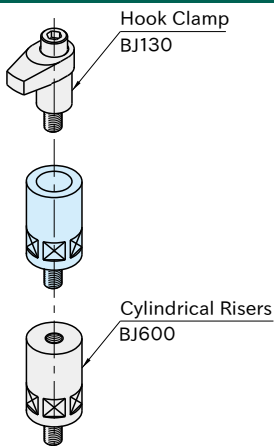

BJ531

HOOK-CLAMP HOLDERS (Flanged)

BJ531 -04016, 06019

BJ531 -08025~16040

Type	Body
BJ531 -04016, 06019	S45C steel Quenched and tempered Black oxide finish
BJ531 -08025~16040	S45C steel Black oxide finish

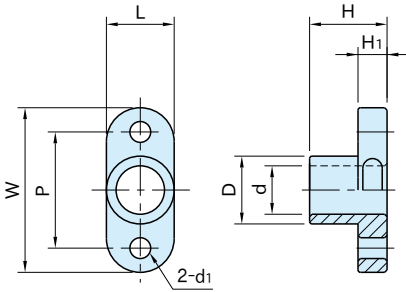
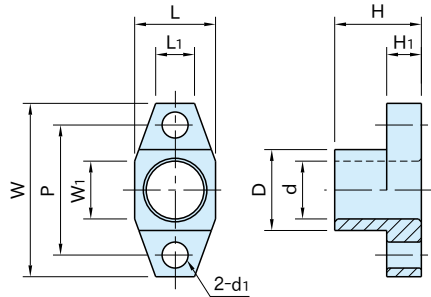
BJ531 -04016, 06019

BJ531 -08025~16040

Part Number	H	W	L	d *)	d ₁	H ₁	P	D	W ₁	L ₁	Weight (g)
BJ531-04016	16	34	14	10	4.3	6	24	14	—	—	20
BJ531-06019	19	40	16	12	5.3	8	28	16	—	—	30
BJ531-08025	25	50	24	18	6.6	10	38	24	15	11.3	85
BJ531-10030	30	60	28	20	9	12	45	28	20	13.4	150
BJ531-12040	40	75	35	25	11	14	55	35		15	290
BJ531-16040		85	42	32	13	16	65	42		25	20.2

*) Tolerance of d Diameter **BJ531-04016** **BJ531-06019** : $+0.1$
BJ531-08025 **BJ531-10030** **BJ531-12040** **BJ531-16040** : F7

Feature

Suitable for low-height clamping.

How To Use

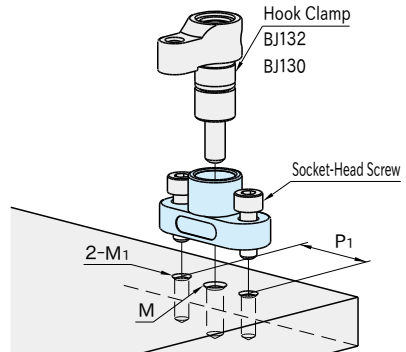

Part Number	M	M ₁	P ₁
BJ531-04016	M 4×0.7 Depth 13	M 4×0.7	24
BJ531-06019	M 6×1 Depth 14	M 5×0.8	28
BJ531-08025	M 8×1.25 Depth 20	M 6×1	38
BJ531-10030	M10×1.5 Depth 21	M 8×1.25	45
BJ531-12040	M12×1.75 Depth 25	M10×1.5	55
BJ531-16040	M16×2 Depth 25	M12×1.75	65

BJ131

HOOK CLAMPS

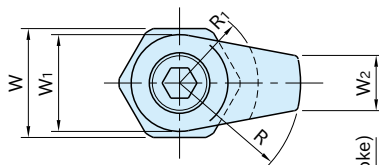

M1 Hex.Socket-Head
Cap Screw

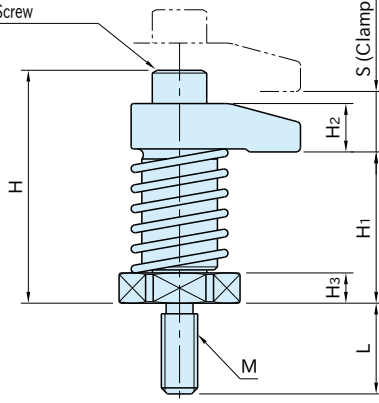

Body
SCM435 steel
Heat treated
Black oxide finish
Precision ground

Part Number	H ₁	S	R	R ₁	M	L	H	W ₁	W ₂	H ₂	W
BJ131-08020	35	10	20	15	M 8×1.25	19	49	22	10	12	22
BJ131-08025			25								
BJ131-08030			30	15 *)							
BJ131-08120	45	10	20	15	M 8×1.25	19	59	22	10	12	22
BJ131-08125			25								
BJ131-08130			30	15 *)							
BJ131-12040	50	15	40	26	M12×1.75	30	77	32	18	16	36
BJ131-12050			50				79			16	
BJ131-12060			60				92			16	
BJ131-12140	65	15	40	26	M12×1.75	30	94	32	18	16	36
BJ131-12150			50							18	
BJ131-12160			60								
BJ131-16040	50	15	40	26	M16×2	30	86	36	22	21	36
BJ131-16050			50								
BJ131-16060			60								
BJ131-16140	65	15	40	26	M16×2	30	101	36	22	21	36
BJ131-16150			50								
BJ131-16160			60								

*) The center of R₁ is located in 5mm outside from the center of the body.

Part Number	H ₃	M ₁	Clamping Force(kN)	Allowable Screw Torque(N·m)	Weight (g)		
BJ131-08020	6	M 8×1.25-30L	7.9	20	125		
BJ131-08025			7.3		130		
BJ131-08030			6.7		135		
BJ131-08120			7.9		160		
BJ131-08125			7.3		165		
BJ131-08130			6.7		170		
BJ131-12040	10	M12×1.75-45L	13.5	45	450		
BJ131-12050			12.6		480		
BJ131-12060			11.7		520		
BJ131-12140	25	M12×1.75-45L	13.5	45	600		
BJ131-12150			12.6		630		
BJ131-12160			11.7		670		
BJ131-16040	10	M16×2 -55L	13.4	60	630		
BJ131-16050			12.4		680		
BJ131-16060			12		740		
BJ131-16140			13.4		780		
BJ131-16150			25		M16×2 -55L	12.4	830
BJ131-16160						12	890

Related Product

BJ600 Cylindrical Risers are available for additional height.

How To Use

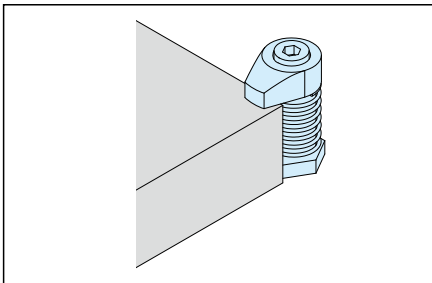

Note

Please put grease on sliding surface to prevent galling when using in dry condition.

