

Gebrauchsanleitung Instructions for use Instructions d'utilisation

CORVARA S 390

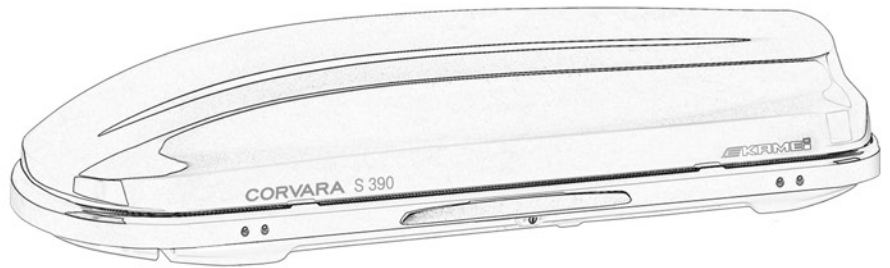

CORVARA S 475



OYSTER 450

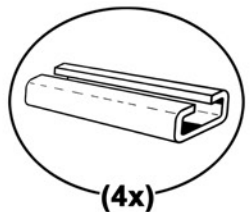
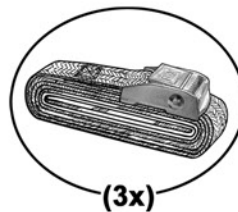
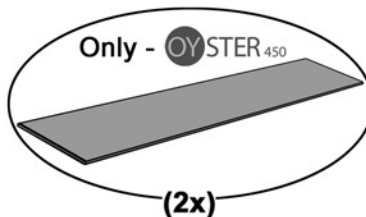
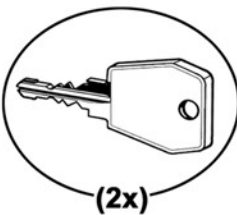

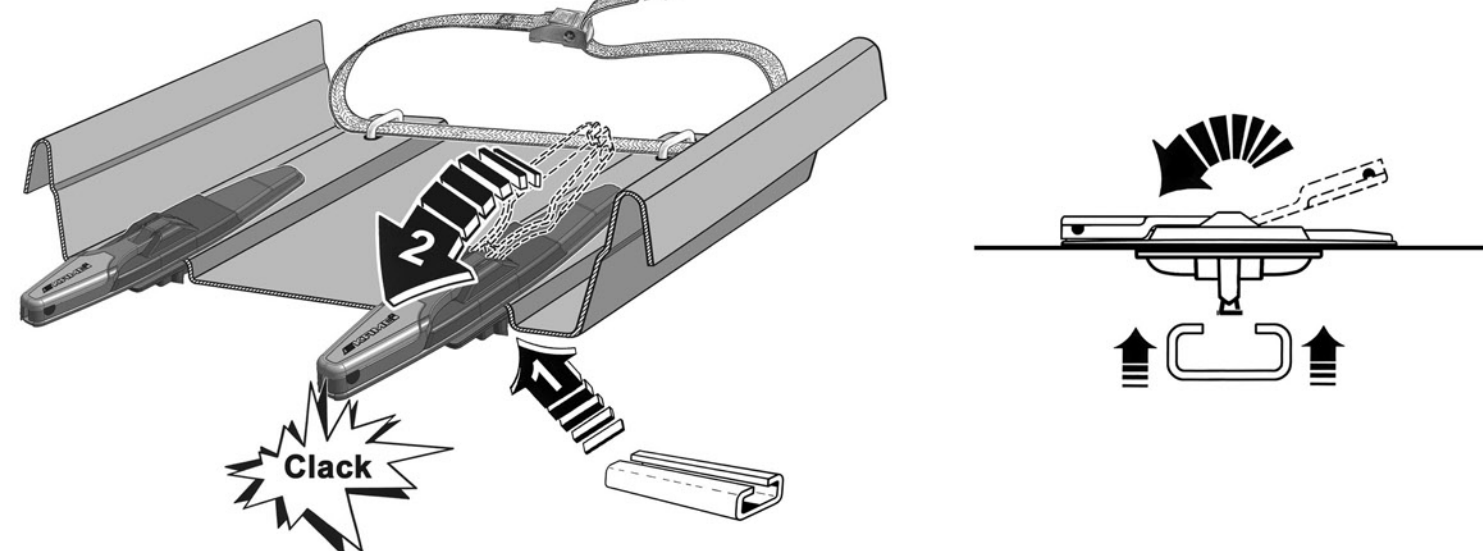
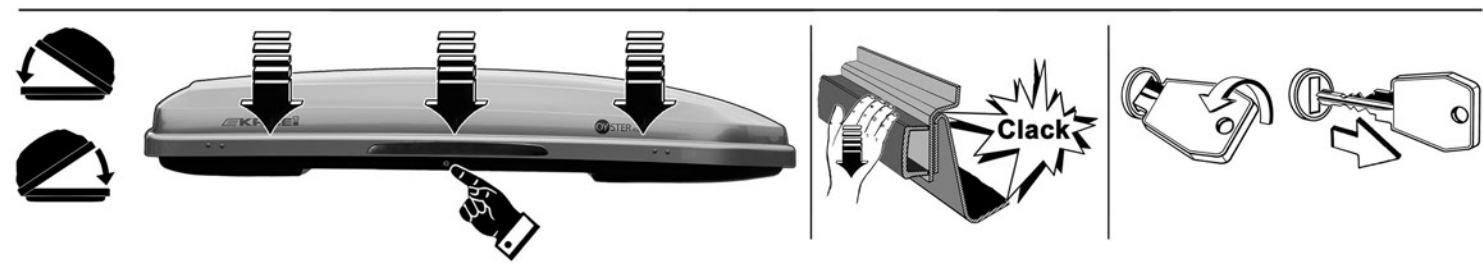
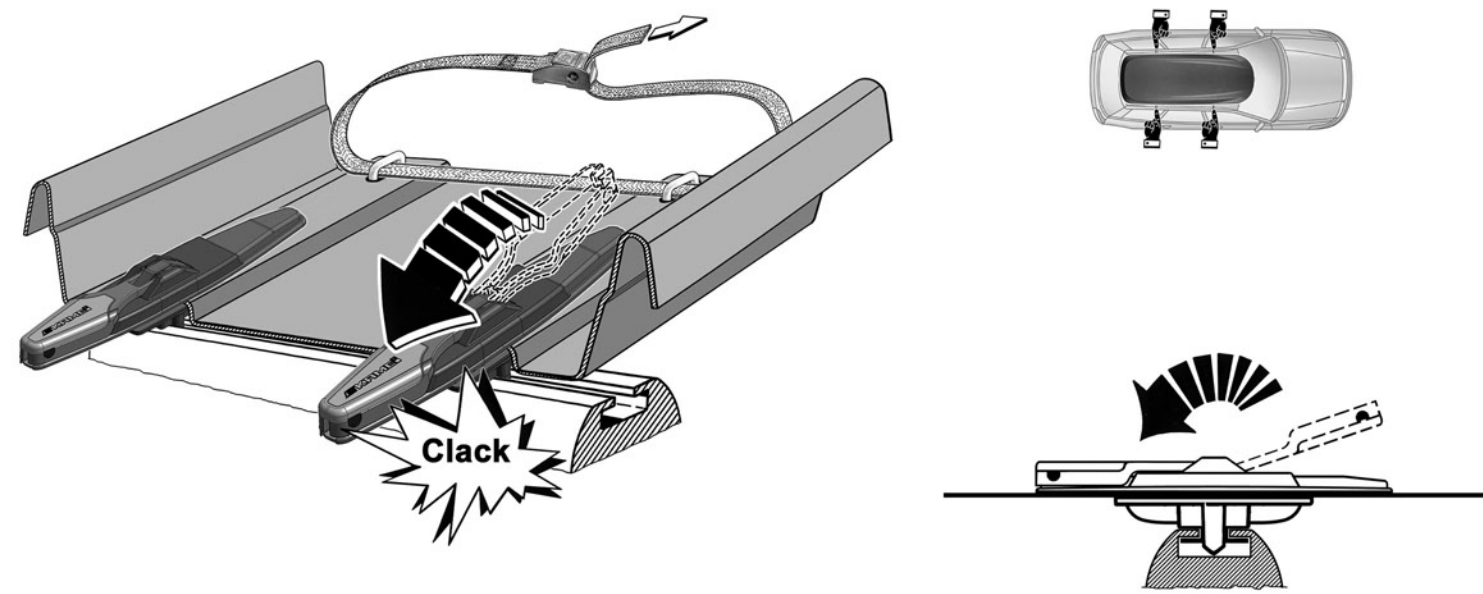
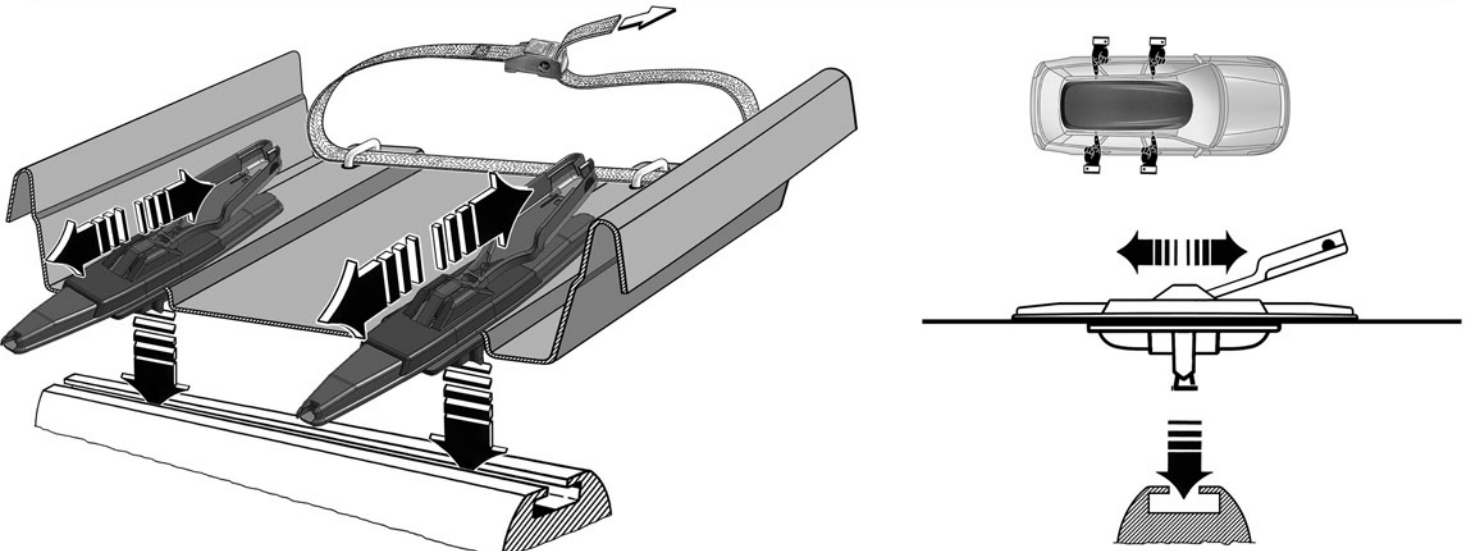
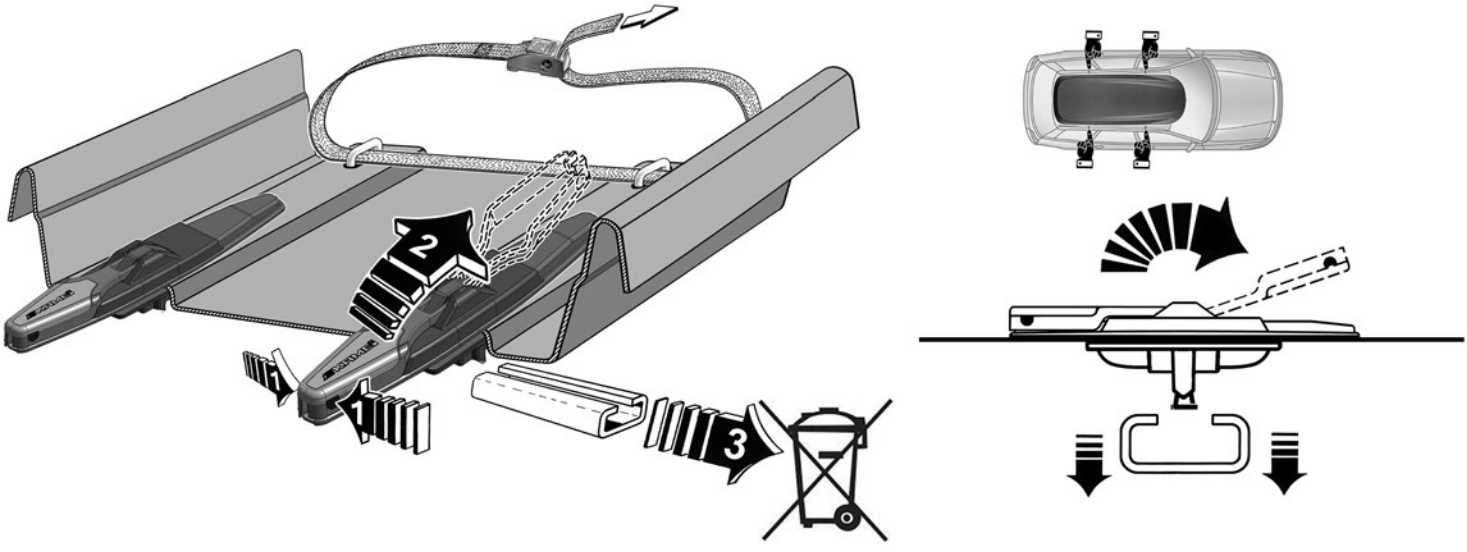
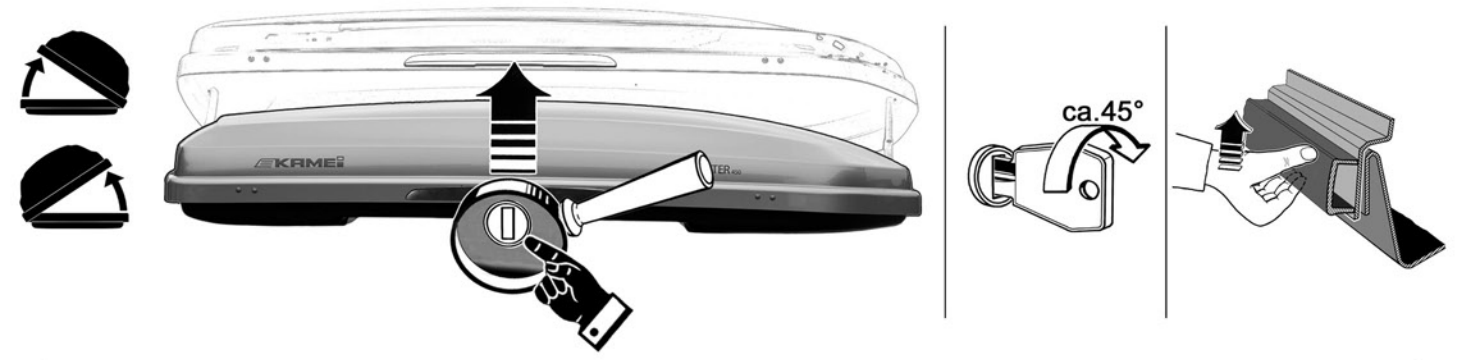
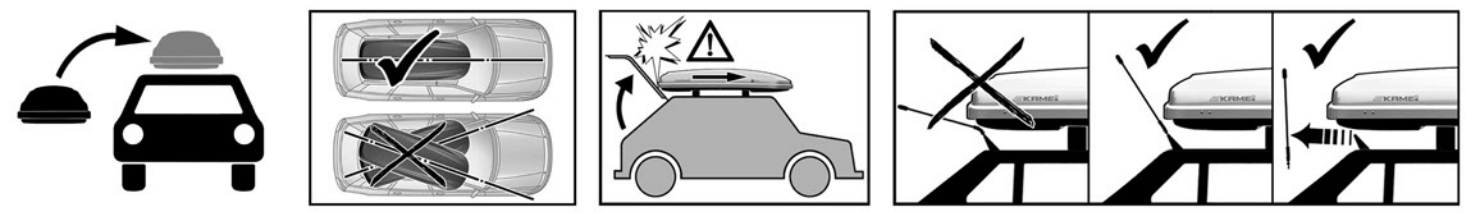
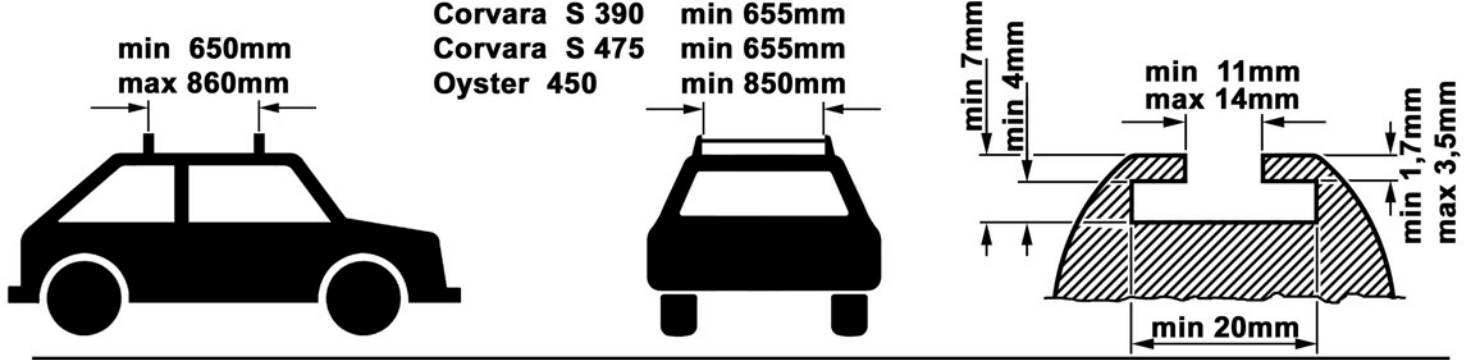

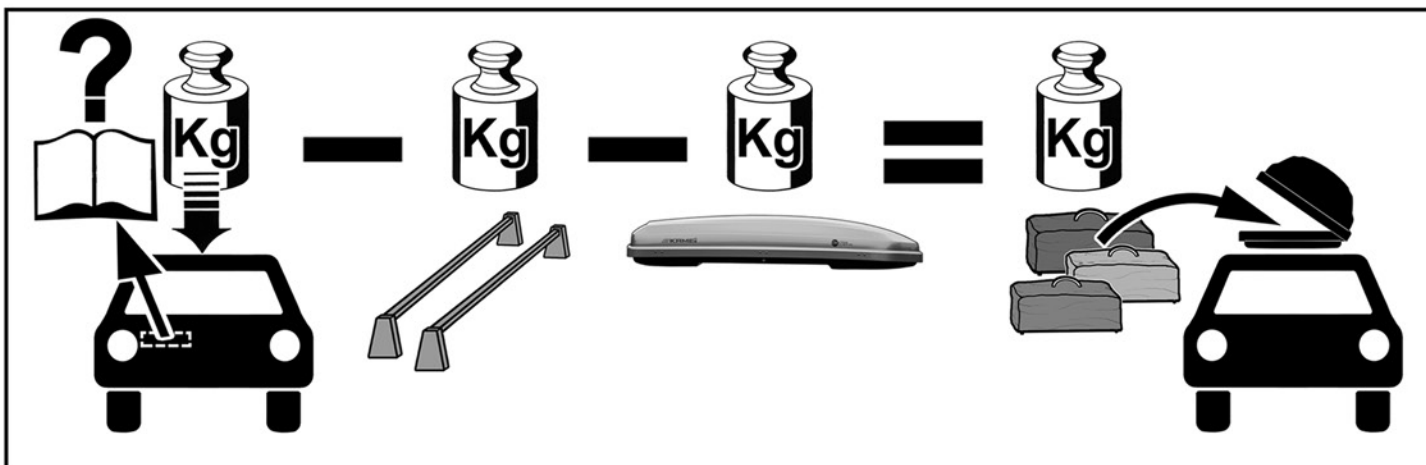
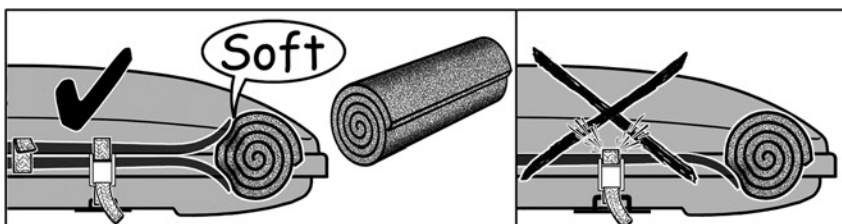
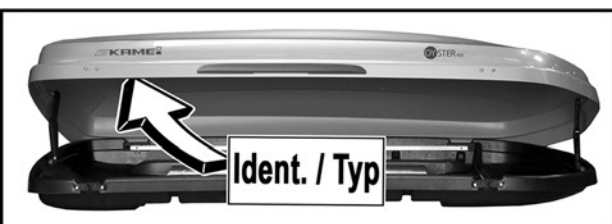
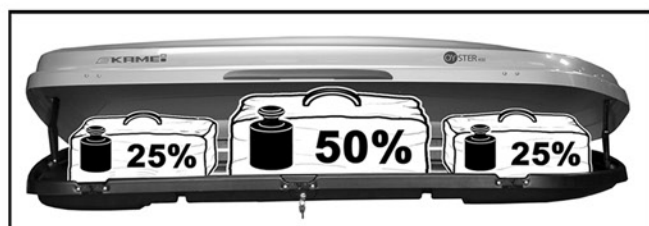
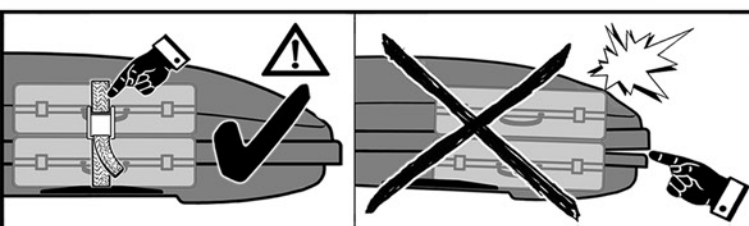
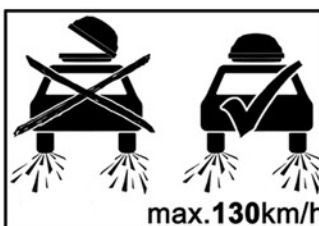
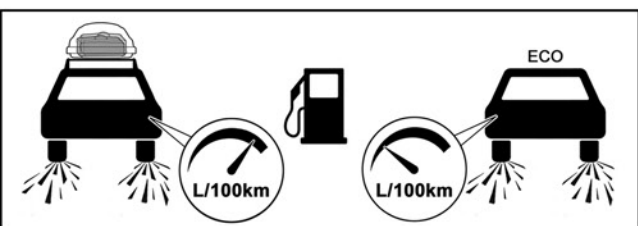
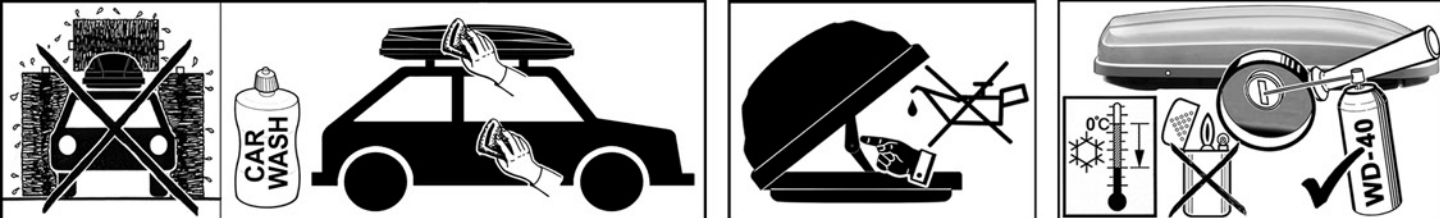

Dachcontainer Typ 81200

Haupt-Verkaufsbezeichnung Auch andere Verkaufsbezeichnungen sind genehmigt	Maße			Volumen Schüttgut Liter	Gewichte		
	Länge cm	Breite cm	Höhe cm		Eigengewicht kg	zulässige Tragfähigkeit kg	Maximalgewicht beladen kg
CORVARA S 390	190	75	43	390	16	75	91
CORVARA S 475	230	75	41	475	19	75	94
OYSTER 450	206	95	36	450	22	75	97

Hersteller: KAMEI GmbH & Co. KG
www.kamei.de

Heinrichswinkel 2 D-38448 Wolfsburg
Tel. 0180 - 526 34 46 36 12 ct/min