

GENERAL CATALOGUE

TECH PORCELAIN

lAnd
PORCELANICO

GENERAL CATALOGUE 2017

INDEX INDICE . ÍNDICE

Pag	COLLECTIONS COLLEZIONI. COLECCIONES
126	AUSTRAL
110	AZULCASCAIS
118	CELTIC
60	CIVIC
202	DAGON
164	GALLERY + SLIM
188	GALLERY WALL
198	ISMO
204	JAMTLAND
203	JERUSALEM
68	KANKARE ^{new}
134	LEGNO + SLIM
80	MATTER + SLIM
158	MENSA
28	MIDLAND ^{new}
16	NOUVEAU
200	ORIGIN
96	PIETRA SERENA
40	PORTLAND + SLIM
4	RAMBLA ^{new}
148	ROOTS
205	COMPLEMENTS

Pag	CONTENTS CONTENUTI. CONTENIDOS
218	CERTIFICATES CERTIFICAZIONI.CERTIFICADOS
219	ENVIRONMENTAL INFORMATION BILANCIO ECOLOGICO.EQUILIBRIO ECOLÓGICO
220	GUIDELINES: INSTALLATION AND MAINTENANCE CONSIGLI PER LA POSA E PULIZIA.CONSEJOS DE COLOCACIÓN Y LIMPIEZA.
223	PACKING LIST IMBALLAGIO.LISTA DE EMBALAJE
217	SLIP RESISTANCE PROPRIETÀ ANTISCIVOLO.PROPIEDADES ANTIDESLIZAMIENTO
206	SPECIAL PIECES PEZZI SPECIALI.PIEZAS ESPECIALES
212	TECHNICAL SOLUTIONS. SOLUZIONI TECNICHE. SOLUCIONES TÉCNICAS
212	FAÇADES.FACCIATE.FACHADAS
214	RAISED FLOORS.PAVIMENTI SOPRAELEVATI.PAVIMENTO SOBREELEVADO
222	DIGITAL PRINTING.STAMPA DIGITALE.IMPRESIÓN DIGITAL
222	WATER JET CUTTING.TAGLIO A GETTO D'AQUA.CORTE DE AGUA
208	3D CONCEPT PEZZI TRIDIMENSIONALE. PIEZAS TRIDIMENSIONALES

PRODUCT INDEX

INDICE DEI PRODOTTI. ÍNDICE DE PRODUCTO

CONCEPTS
CONCEPTOS

PAGE
PAGINA

COLLECTIONS
COLLEZIONI. COLECCIONES

COLOURS
COLORI. COLORES

FINISHES
FINITURE. ACABADOS

CONCEPTS	PAGE	COLLECTIONS	COLOURS	FINISHES
CONCEPTOS	PAGINA	COLLEZIONI. COLECCIONES	COLORI. COLORES	FINITURE. ACABADOS
ENCAUSTIC tech	04	RAMBLA ^{new}	ivory abyss alchemy clip random	natural
	16	NOUVEAU	ivory light dark random inox	natural lappato
CONCRETE tech	28	MIDLAND ^{new}	ivory vison grey	natural corrugato
	40	PORTLAND + SLIM	ivory vison grey	natural lappato slim natural hexagon
	60	CIVIC	ivory grey antracita	natural
	200	ORIGIN	marfil crema gris savanna antracita	natural lappato
STONE tech	68	KANKARE ^{new}	ivory vison grey	natural
	80	MATTER + SLIM	ivory grey	natural slim natural square
	96	PIETRA SERENA	ivory beige moss graphite	natural lappato filosega rigato bocciardato
	110	AZULCASCAIS	ivory moss graphite	natural lappato strutturato
	203	JERUSALEM	ivory vison grey	natural
	118	CELTIC	olive black	estrutturato
	126	AUSTRAL	ivory copper antracita	estrutturato
	204	JAMTLAND	ivory graphite	natural lappato
	202	DAGON	marfil beige siena vison savanna	natural lappato
	WOOD tech	134	LEGNO + SLIM	ice noce titanium
148		ROOTS	white maple oak	estrutturato
158		MENSA	savanna graphite	natural non slip
198		ISMO	marfil beige moka antracita	natural lappato
COLOUR wall tech	164	GALLERY + SLIM	white yellow lime orange blue red black	pulido satinado righe slim natural hexagon square
	188	GALLERY WALL	white lime orange blue red black	brillo mate

FORMATS
FORMATI. FORMATOS

SPECIAL PIECES
PEZZI SPECIALI. PIEZAS ESPECIALES



PAGE
PAGINA

			CLASE 2 R10 natural	04
			CLASE 1 R10 natural	16
			CLASE 1 R9 natural CLASE 3 R11 corrugato	28
slim		slim	CLASE 1 R9 natural CLASE 2 R10 lappato	40
			CLASE 1 R9 natural	60
			CLASE 1 R9 natural / lappato	200
			CLASE 1 R9 natural CLASE 3 R10 non-slip	68
slim		slim	CLASE 1 R9 natural CLASE 2 R10 lappato	80
			CLASE 1 R9 natural CLASE 3 R11 filosega / rigato CLASE 2 R10 bocciardato	96
			CLASE 1 R10 natural CLASE 3 R12 strutturado	110
			CLASE 1 R9 natural	203
			CLASE 1 R9 natural	118
			CLASE 1 R9 natural	126
			CLASE 1 R9 natural	204
 <small>Kefren Micerino</small>			CLASE 1 R9 natural / lappato	202
slim			CLASE 1 R10 natural	134
			CLASE 3 R11 natural	148
			CLASE 1 R9 natural CLASE 3 R11 non-slip	158
			CLASE 1 R9 natural / lappato	198
slim		slim	CLASE 1 R9 mate	164
				188

RAMBLA



ENCAUSTIC



* Rambla random natural. Content of recycled material.

FORMATS.FORMATI.FORMATOS



30X30
29,75x29,75 cm - 11.71"x11.71"

SPECIAL PIECES.PEZZI SPECIALI.PIEZAS ESPECIALES



30X30 mosaico 5x5
29,75x29,75 cm - 11.71"x11.71"



Rodapié 7,5x30
7,3x29,75 cm - 2.92"x11.71"

THICKNESS.SPESSORE.ESPESORES

 1 cm approx. / 0.39" approx.

COLOURS COLORI COLORES



Ivory

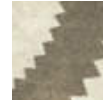

Abyss



Alchemy



Clip



Random

FINISHES FINITURI ACABADOS



Natural

RAMBLA

RAMBLA **abyss**

PLAIN TILES.BASE.BASES



Rambla abyss natural
29,75x29,75 cm - 11.71"x11.71"
G-6286



Rambla ivory natural
29,75x29,75 cm - 11.71"x11.71"
G-6286

CLASE 2 | **R10****

UNE - ENV 12633

DCOF>0.42

ANSI A 137.1 - 2012

** For projects check technical information with our commercial network.
Para proyectos obtenga información técnica a través de nuestra red comercial.

SPECIAL PIECES.PEZZI SPECIALI. PIEZAS ESPECIALES



**Rambla ivory natural
mosaico 5x5**
29,75x29,75 cm - 11.71"x11.71"
G-6666



Rambla ivory natural rodapié
7,3x29,75 cm - 2.92"x11.71"
G-5065





RAMBLA

Rambla Abyss Natural 29,75x29,75 cm

RAMBLA **alchemy**

PLAIN TILES.BASE.BASES



Rambla alchemy natural
29,75x29,75 cm - 11.71"x11.71"
G-6286



Rambla ivory natural
29,75x29,75 cm - 11.71"x11.71"
G-6286

CLASE 2 | **R10****

UNE - ENV 12633

DCOF>0.42

ANSI A 137.1 - 2012

** For projects check technical information with our commercial network.
Para proyectos obtenga información técnica a través de nuestra red comercial.

SPECIAL PIECES.PEZZI SPECIALI. PIEZAS ESPECIALES



Rambla ivory natural mosaico 5x5
29,75x29,75 cm - 11.71"x11.71"
G-6666



Rambla ivory natural rodapié
7,3x29,75 cm - 2.92"x11.71"
G-5065





RAMBLA

Rambla Alchemy Natural 29,75x29,75 cm

RAMBLA clip

PLAIN TILES.BASE.BASES



Rambla clip natural
29,75x29,75 cm - 11.71"x11.71"
G-6286



Rambla ivory natural
29,75x29,75 cm - 11.71"x11.71"
G-6286

CLASE 2 | **R10****
UNE - ENV 12633

DCOF>0.42
ANSI A 137.1 - 2012

** For projects check technical information with our commercial network.
Para proyectos obtenga información técnica a través de nuestra red comercial.

SPECIAL PIECES.PEZZI SPECIALI. PIEZAS ESPECIALES



Rambla ivory natural mosaico 5x5
29,75x29,75 cm - 11.71"x11.71"
G-6666



Rambla ivory natural rodapié
7,3x29,75 cm - 2.92"x11.71"
G-5065





RAMBLA

Rambla Clip Natural 29,75x29,75 cm

RAMBLA random

PLAIN TILES.BASE.BASES

CLASE 2 **R10** **DCOF>0.42**
 UNE - ENV 12633 DIN 51130 ANSI A 137.1 - 2012



Rambla random natural*
 29,75x29,75 cm - 11.71"x11.71"
G-6286



Rambla ivory natural
 29,75x29,75 cm - 11.71"x11.71"
G-6286

***13 DIFFERENT ALEATORY PATTERNS.**
***13 DECORACIONES DIFERENTES ALEATORIAS**

** For projects check technical information with our commercial network.
 ** Para proyectos obtenga información técnica a través de nuestra red comercial.

SPECIAL PIECES. PEZZI SPECIALI.PIEZAS ESPECIALES



Rambla random nat
mosaico 5x5
 29,75x29,75 cm
G-6666

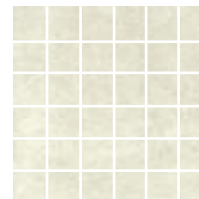

Rambla ivory natural
mosaico 5x5
 29,75x29,75 cm - 11.71"x11.71"
G-6666

















Rambla ivory natural rodapié
 7,3x29,75 cm - 2.92"x11.71"
G-5065



RAMBLA

Rambla Random Natural 29,75x29,75 cm

TECHNICAL CHARACTERISTICS. CARATTERISTICHE TECNICHE. CARACTERÍSTICAS TÉCNICAS

MEASUREMENTS AND SURFACES APPEARANCE / DIMENSIONI E ASPETTO SUPERFICIALE / MEDIDAS Y ASPECTO SUPERFICIAL / MASSEN UND AUSSEHEN DER OBERFLÄCHE		STANDARD TEST METHOD METODO DELLA NORMA MÉTODO DE ENSAYO STANDARD TEST METHOD	STANDARD PRESCRIBED VALUES VALORE PRESCRITTO VALORES STANDARD NORMA STANDARDWERTE	RAMBLA collection
 Length and width. <i>Lunghezza e larghezza.</i> Longitud y anchura. Länge und Breite		ISO 10545-2	± 0,6% max.	± 0,1% *
 Orthogonality. <i>Ortogonalità.</i> Ortogonalidad. Rechtwinkligkeit		ISO 10545-2	± 0,6% max.	± 0,2% *
 Straightness of sides. <i>Rettilinearità dei lati.</i> Rectitud de lados. Kantengeradigkeit		ISO 10545-2	± 0,5% max.	± 0,2% *
 Surfaces flatness. <i>Planarità.</i> Planitud. Ebenflächigkeit		ISO 10545-2	± 0,5% max.	± 0,2% *
PHYSICAL PROPERTIES / PROPIETÀ FISICHE / PROPIEDADES FÍSICAS / PHYSIKALISCHE EIGENSCHAFTEN				
 Water absorption. <i>Assorbimento d'acqua.</i> Absorción de agua. Wasseraufnahme		ISO 10545-3	≤ 0,5%	≤ 0,1%
 Breaking strength, in N. <i>Carico di rottura, in N.</i> Carga de rotura, en N. Bruchlast, in N	thickness > 7,5 mm spessore > 7,5 mm grösor > 7,5 mm	ISO 10545-4	1300 N	≥ 2400 N *
 Modulus of rupture. <i>Resistenza alla flessione.</i> Resistencia a la flexión. Biegefestigkeit		ISO 10545-4	≥ 35 N/mm ²	56 N/mm ² *
 Resistance to deep abrasion. <i>Resistenza all'abrasione profonda.</i> Resistencia a la abrasión profunda. Tiefverschleissbeständigkeit		ISO 10545-6	≤ 175 mm ³	115 mm ³ *
 Resistance to thermal shock. <i>Resistenza agli sbalzi termici.</i> Resistencia al choque térmico. Temperaturwechselbeständigkeit		ISO 10545-9	No surface defects should be visible <i>Non deve presentare difetti visibili</i> No debe presentar defectos superficiales visibles	Resistant. Resistente. Resistente
 Frost resistance. <i>Resistenza al gelo.</i> Resistencia a la helada. Frostbeständigkeit		ISO 10545-12	No surface defects or cracks should be visible <i>Non deve presentare difetti visibili</i> No debe presentar defectos ni grietas superficiales visibles	Frost Resistance <i>Antighiaccio</i> Resistente a la Helada
 Coefficient of friction. <i>Resistenza allo scivolamento.</i> Coeficiente de fricción. Rutschfestigkeit		DIN 51130 UNE - ENV 12633	WET TEST/ENSAYO EN HÚMEDO DRY TEST/ENSAYO EN SECO	R10** Clase I *** DCOF - ANSIA 137.1-2012 > 0.42
 Colour resistance to light. <i>Resistenza dei colori alla luce.</i> Resistencia del color a la luz. Lichtbeständigkeit der Farben		DIN 51094	There should be no colour variations <i>Non deve presentare difetti visibili</i> No debe presentar variaciones de color	No alterations in colour and shine <i>Non presentar alterazioni di colori e lucidità</i> No presentar variaciones de color y brillo
CHEMICAL PROPERTIES / PROPIETÀ CHIMICHE / PROPIEDADES QUÍMICAS / CHEMISCHEN EIGENSCHAFTEN				
 Chemical resistance. <i>Resistenza agli agenti chimici.</i> Resistencia química. Chemikalienbeständigkeit		ISO 10545-13	Resistance to household cleaning products and swimming-pools salts. <i>Resistencia a productos domésticos y sales para piscinas.</i>	Min. UB
 Resistance to staining. <i>Resistenza alle macchie.</i> Resistencia a las manchas. Fleckenbeständigkeit		ISO 10545-14	≥ 3	5 *

*Natural finish. The Lab values are the average of different production consignments. For further detail information, please check with our commercial network. /

I valori dichiarati sono ottenuti da una media di prove effettuate su diverse produzioni. Per avere informazioni dettagliate consultare la rete commerciale /

Los valores declarados son el promedio obtenido a través de ensayos de diferentes producciones. Para la obtención de una información detallada consultar a la red comercial.

** Tested in Natural finish. For projects check technical information with our commercial networks. /

Per progetti ottenere informazioni tecniche attraverso la nostra rete commerciale. / Para proyectos obtenga información técnica a través de nuestra red comercial.

*** Tested in Natural finish. (It depends on the consignment) Test realized in internal laboratory. / Prova effettuata in laboratorio interno. / Ensayo realizado en laboratorio interno.

**** Dry Test, according to document DA DB-SUA/3 (Código Técnico de la Edificación) M° de Fomento.

Ensayo realizado, según documento DA DB-SUA/3 (Código Técnico de la Edificación) M° de Fomento



RAMBLA

Rambla Random Natural 29,75x29,75 cm

NOUVEAU



ENCAUSTIC



VINEYARD HOTEL
Cape Town. (South Africa)



WINE BOUTIQUE
San José. (Costa Rica)

* Nouveau random grey natural. Content of recycled material.

FORMATS.FORMATI.FORMATOS



30X30
29,75x29,75 cm - 11.71"x11.71"

SPECIAL PIECES.PEZZI SPECIALI.PIEZAS ESPECIALES



30X30 mosaico 5x5
29,75x29,75 cm - 11.71"x11.71"



Rodapié 7,5x30
7,3x29,75 cm - 2.92"x11.71"

THICKNESS.SPESSORE.ESPESORES

± 1 cm approx. / 0.39" approx.

COLOURS COLORI COLORES



Ivory



Light



Dark



Random



Inox

FINISHES FINITURI ACABADOS



Natural



Lappato

NOUVEAU

NOUVEAU random grey

PLAIN TILES.BASE.BASES



Nouveau random grey natural*

29,75x29,75 cm - 11.71"x11.71"

G-6286

***30 DIFFERENT ALEATORY PATTERNS.**

30 DECORACIONES DIFERENTES ALEATORIAS

CLASE 1 | **R10****

UNE - ENV 12633 | DIN 51130

DCOF>0.42

ANSI A 137.1 - 2012

** For projects check technical information with our commercial network.
Para proyectos obtenga información técnica a través de nuestra red comercial.



Nouveau Ivory natural

29,75x29,75 cm - 11.71"x11.71"

G-6286

SPECIAL PIECES.
PEZZI SPECIALI. PIEZAS ESPECIALES



**Nouveau random grey nat
mosaico 5x5**
29,75x29,75 cm
G-6666



**Nouveau ivory natural
mosaico 5x5**
29,75x29,75 cm - 11.71"x11.71"
G-6666



Nouveau ivory natural rodapié
7,3x29,75 cm - 2.92"x11.71"
G-5065



Nouveau Random Grey Natural 29,75x29,75 cm

NOUVEAU dark grey

PLAIN TILES.BASE.BASES



Nouveau dark grey natural

29,75x29,75 cm - 11.71"x11.71"

G-6286



Nouveau ivory natural

29,75x29,75 cm - 11.71"x11.71"

G-6286

CLASE 1

UNE - ENV 12633

R10**

DIN 51130

DCOF>0.42

ANSI A 137.1 - 2012

** For projects check technical information with our commercial network.
Para proyectos obtenga información técnica a través de nuestra red comercial.

SPECIAL PIECES.PEZZI SPECIALI. PIEZAS ESPECIALES



**Nouveau ivory natural
mosaico 5x5**

29,75x29,75 cm - 11.71"x11.71"

G-6666



Nouveau ivory natural rodapié

7,3x29,75 cm - 2.92"x11.71"

G-5065





NOUVEAU

Nouveau Dark Grey Natural_ Ivory Natural 29,75x29,75 cm

NOUVEAU light grey

PLAIN TILES.BASE.BASES



Nouveau light grey natural
29,75x29,75 cm - 11.71"x11.71"
G-6286



Nouveau ivory natural
29,75x29,75 cm - 11.71"x11.71"
G-6286

CLASE 1

UNE - ENV 12633

R10**

DIN 51130

DCOF>0.42

ANSI A 137.1 - 2012

** For projects check technical information with our commercial network.
Para proyectos obtenga información técnica a través de nuestra red comercial.

SPECIAL PIECES.PEZZI SPECIALI. PIEZAS ESPECIALES

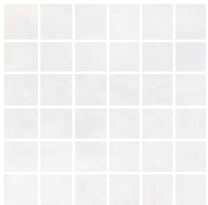

Nouveau ivory natural mosaico 5x5
29,75x29,75 cm - 11.71"x11.71"
G-6666



Nouveau ivory natural rodapié
7,3x29,75 cm - 2.92"x11.71"
G-5065





NOUVEAU

Nouveau Light Grey Natural_Ivory Natural 29,75x29,75 cm

NOUVEAU random inox

PLAIN TILES.BASE.BASES

CLASE 1

UNE - ENV 12633

DCOF>0.42

ANSI A 137.1 - 2012

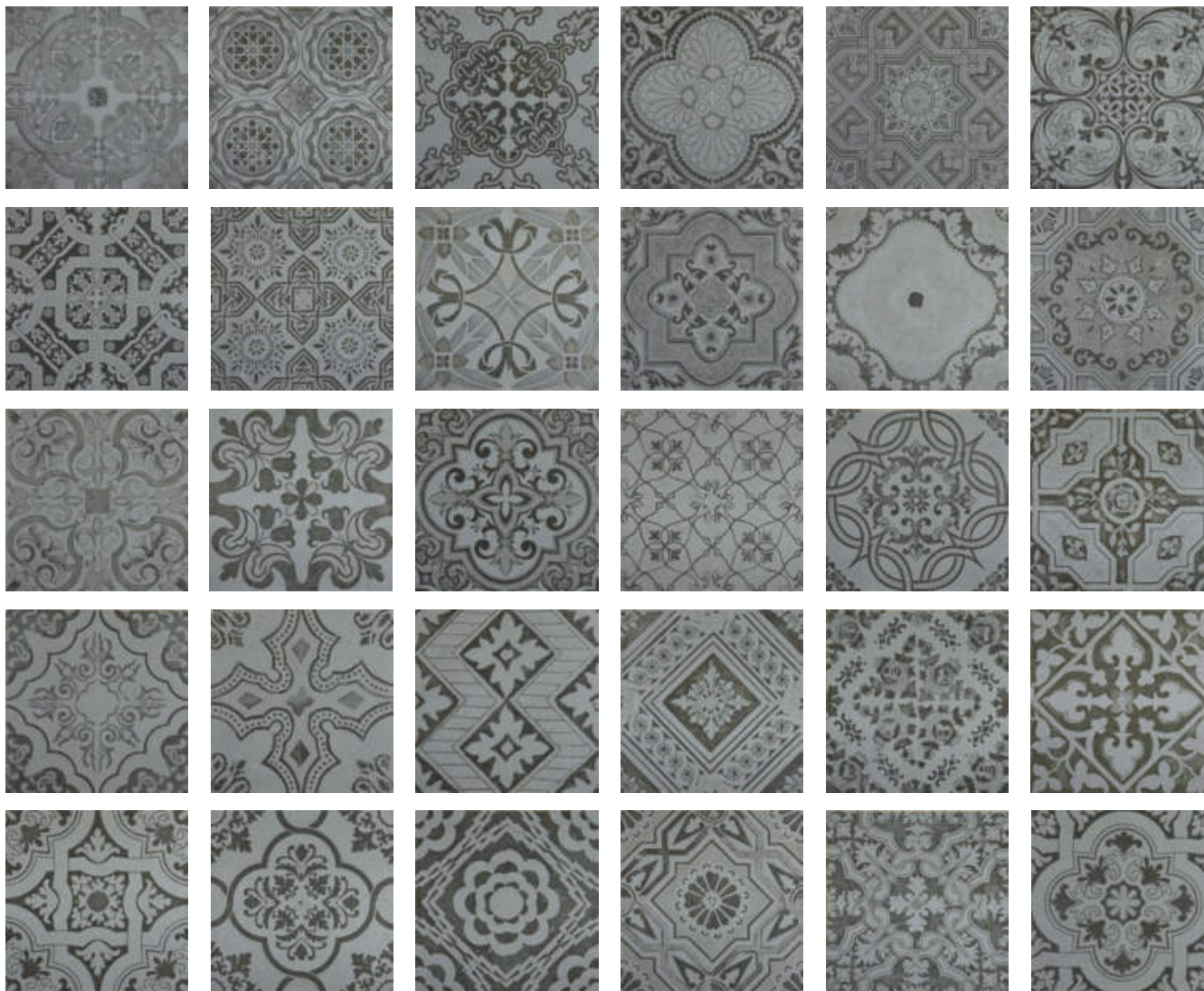

Nouveau iandom inox lappato*

29,75x29,75 cm - 11.71"x11.71"

6-6372















***30 DIFFERENT ALEATORY PATTERNS.**
30 DECORACIONES DIFERENTES ALEATORIAS



NOUVEAU

Nouveau Random Inox Lappato 29,75x29,75 cm

TECHNICAL CHARACTERISTICS. CARATTERISTICHE TECNICHE. CARACTERÍSTICAS TÉCNICAS

MEASUREMENTS AND SURFACES APPEARANCE / DIMENSIONI E ASPETTO SUPERFICIALE / MEDIDAS Y ASPECTO SUPERFICIAL / MASSEN UND AUSSEHEN DER OBERFLÄCHE		STANDARD TEST METHOD METODO DELLA NORMA MÉTODICO DE ENSAYO STANDARD TEST METHOD	STANDARD PRESCRIBED VALUES VALORE PRESCRITTO VALORES STANDARD NORMA STANDARDWERTE	NOUVEAU collection *
 Length and width. <i>Lunghezza e larghezza.</i> Longitud y anchura. Länge und Breite		ISO 10545-2	± 0,6% max.	± 0,1% *
 Orthogonality. <i>Ortogonalità.</i> Ortogonalidad. Rechtwinkligkeit		ISO 10545-2	± 0,6% max.	± 0,2% *
 Straightness of sides. <i>Rettilinearità dei lati.</i> Rectitud de lados. Kantengeradigkeit		ISO 10545-2	± 0,5% max.	± 0,2% *
 Surfaces flatness. <i>Planarità.</i> Planitud. Ebenföchigkeit		ISO 10545-2	± 0,5% max.	± 0,2% *
PHYSICAL PROPERTIES / PROPIETÀ FISICHE / PROPIEDADES FÍSICAS / PHYSIKALISCHE EIGENSCHAFTEN				
 Water absorption. <i>Assorbimento d'acqua.</i> Absorción de agua. Wasseraufnahme		ISO 10545-3	≤ 0,5%	≤ 0,1%
 Breaking strength, in N. <i>Carico di rottura, en N.</i> Carga de rotura, en N. Bruchlast, in N	thickness>7,5 mm spessore>7,5 mm grosor>7,5 mm	ISO 10545-4	1300 N	≥ 2400 N *
 Modulus of rupture. <i>Resistenza alla flessione.</i> Resistencia a la flexión. Biegefestigkeit		ISO 10545-4	≥ 35 N/mm ²	56 N/mm ² *
 Resistance to deep abrasion. <i>Resistenza all'abrasione profonda.</i> Resistencia a la abrasión profunda. Tiefverschleissbeständigkeit		ISO 10545-6	≤ 175 mm ³	115 mm ³ *
 Resistance to thermal shock. <i>Resistenza agli sbalzi termici.</i> Resistencia al choque térmico. Temperaturwechselbeständigkeit		ISO 10545-9	No surface defects should be visible <i>Non deve presentare difetti visibili</i> No debe presentar defectos superficiales visibles	Resistant. <i>Resistente. Resistente</i>
 Frost resistance. <i>Resistenza al gelo.</i> Resistencia a la helada. Frostbeständigkeit		ISO 10545-12	No surface defects or cracks should be visible <i>Non deve presentare difetti visibili</i> No debe presentar defectos ni grietas superficiales visibles	Frost Resistance <i>Antighiaccio</i> Resistente a la Helada
 Coefficient of friction. <i>Resistenza allo scivolamento.</i> Coeficiente de fricción. Rutschfestigkeit		DIN 51130 UNE - ENV 12633	WET TEST/ENSAYO EN HÚMEDO DRY TEST/ENSAYO EN SECO	R10** Clase I *** Clase 3 **** DCOF - ANSIA 137.1-2012 > 42
 Colour resistance to light. <i>Resistenza dei colori alla luce.</i> Resistencia del color a la luz. Lichtbeständigkeit der Farben		DIN 51094	There should be no colour variations <i>Non deve presentare difetti visibili</i> No debe presentar variaciones de color	No alterations in colour and shine <i>Non presenta alterazioni di colori e lucentezza</i> No presenta variaciones de color y brillo
CHEMICAL PROPERTIES / PROPIETÀ CHIMICHE / PROPIEDADES QUÍMICAS / CHEMISCHEN EIGENSCHAFTEN				
 Chemical resistance. <i>Resistenza agli agenti chimici.</i> Resistencia química. Chemikalienbeständigkeit		ISO 10545-13	Resistance to household cleaning products and swimming pools salts. <i>Resistencia a productos de limpieza y sales para piscinas.</i>	Min. UB
 Resistance to staining. <i>Resistenza alle macchie.</i> Resistencia a las manchas. Fleckenbeständigkeit		ISO 10545-14	≥ 3	5 *

*Natural finish. The Land values are the average of different production consignments. For further detail information, please check with our commercial network. /

I valori dichiarati sono ottenuti da una media di prove effettuate su diverse produzioni. Per avere informazioni dettagliate consultare la rete commerciale /

Los valores declarados son el promedio obtenido a través de ensayos de diferentes producciones. Para la obtención de una información detallada consultar a la red comercial.

** Tested in Natural finish. For projects check technical information with our commercial networks. /

Per progetti ottenere informazioni tecniche attraverso la nostra rete commerciale. / Para proyectos obtenga información técnica a través de nuestra red comercial.

*** Clase I - Tested in Natural finish. (It depends on the consignment) Test realized in internal laboratory. / Prova effettuata in laboratorio interno. / Ensayo realizado en laboratorio interno.

**** Dry Test, according to document DA DB-SUA/3 (Código Técnico de la Edificación) M° de Fomento. Test done in Nouveau Random Grey 30x30 on October 2014.

Ensayo realizado, según documento DA DB-SUA/3 (Código Técnico de la edificación) M° de Fomento, sobre el producto Nouveau Random Grey 30x30 a fecha octubre 2014



NOUVEAU

Nouveau Dark Grey 29,75x29,75 cm - Legno Ice 14,74x89,46 cm

MIDLAND



STONE



* Midland ivory natural. Content of recycled material. Contenido de material reciclado.

FORMATS.FORMATI.FORMATOS



60X120
59,55x119,3 cm - 23.45"x46.97"



60X60
59,55x59,55 cm - 23.45"x23.45"



30X60
29,75x59,55 cm - 11.71"x23.45"

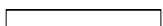

7,5X60
7,3x59,55 cm - 2.87"x23.45"

SPECIAL PIECES.PEZZI SPECIALI.PIEZAS ESPECIALES

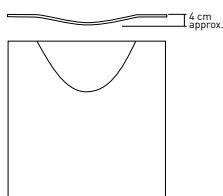

60x120 Bag*
59,55x119,30 cm - 23.45"x46.96"
60X60 Bag*
59,55x59,55 cm - 23.45"x23.45"
30X60 Bag*
29,75x59,55 cm - 11.71"x23.45"

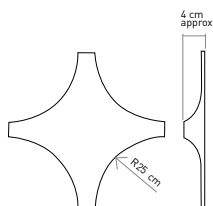

60X60 Star*
59,55x58,88 cm - 23.45"x23.18"

+ INFO pag. 210

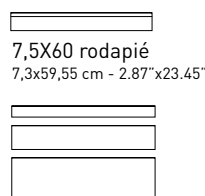

7,5X60 rodapié
7,3x59,55 cm - 2.87"x23.45"

15X60 - 10X60 - 5X60 multiformat natural*
14,75x59,55 cm - 5.87"x23.45"
9,72x59,55 cm - 3.83"x 23.45"
4,84x59,55 cm - 1.90"x23.45"

*The box contains 5 pieces from each of the formats.
cada caja contiene 5 piezas de cada formato.



30X30 mosaico 5x5
29,75x29,75 cm - 11.71"x11.71"



30X30 mosaico 5x5 Multex
29,75x29,75 cm - 11.71"x11.71"



30X30 mosaico 3D
28,5x28,5 cm 11.22"x11.22"

THICKNESS.SPESSORE.ESPESORES

≡ 0,74 cm / 0.29" approx.

COLOURS COLORI COLORES



Ivory

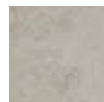

Grey



Vison

FINISHES FINITURI ACABADOS



Natural



Corrugato

PLAIN TILES.BASE.BASES



Midland ivory natural
119,30x 59,55 cm - 46.96" x 23.45"
G-6372



Midland ivory natural
59,55 x 59,55 cm - 23.45" x 23.45"
G-6224



Midland ivory natural
29,75 x 59,55 cm - 11.71" x 23.45"
G-6194

Natural	CLASE 1	R9
	UNE - ENV 12633	DIN 51130
	DCOF>0.42	
	ANSI A 137.1 - 2012	
Corrugato	CLASE 3	R11
	UNE - ENV 12633	DIN 51130

SPECIAL PIECES. PEZZI SPECIALI. PIEZAS ESPECIALES



Midland ivory corrugato
29,75 x 59,55 cm - 11.71" x 23.45"
G-6234



Midland ivory natural multiformato
4,84x59,55_9,72x59,55_14,75x59,55 cm
1.90"x23.45"_3.82"x23.45"_5.80"x23.45"
G-6346



Midland ivory rodapié-60
7,3 x 59,55 cm - 2.87" x 23.45"
G-5091



Midland ivory natural lista 60
7,3 x 59,55 cm - 2.87" x 23.45"
G-5087

* Midland mosaico 3D contains approximately 12'3 pieces/m²
* Midland mosaico 3D contiene aproximadamente 12,3 piezas/m²



MIDLAND

Midland Ivory Natural 59,55x119,30 cm_Midland Ivory Mosaico 3D 28,5x28,5 cm

PLAIN TILES.BASE.BASES



Midland grey natural
119,30x 59,55 cm - 46.96" x 23.45"
G-6372



Midland grey natural
59,55 x 59,55 cm - 23.45" x 23.45"
G-6224



Midland grey natural
29,75 x 59,55 cm - 11.71" x 23.45"
G-6194

Natural	CLASE 1	R9
	UNE - ENV 12633	DIN 51130
	DCOF>0.42	
	ANSI A 137.1 - 2012	
Corrugato	CLASE 3	R11
	UNE - ENV 12633	DIN 51130

SPECIAL PIECES. PEZZI SPECIALI. PIEZAS ESPECIALES



Midland grey corrugato
29,75 x 59,55 cm - 11.71" x 23.45"
G-6234



Midland grey natural multiformato
4,84x59,55_9,72x59,55_14,75x59,55 cm
1.90"x23.45" _3.82"x23.45" _5.80"x23.45"
G-6346

* Midland mosaico 3D contains approximately 12,3 pieces/m²
* Midland mosaico 3D contiene aproximadamente 12,3 piezas/m²



Midland grey rodapié-60
7,3 x 59,55 cm - 2.87" x 23.45"
G-5091



Midland grey natural lista 60
7,3 x 59,55 cm - 2.87" x 23.45"
G-5087



MIDLAND

Midland Grey Natural 59,55x119,30 cm

PLAIN TILES.BASE.BASES



Midland vison natural
119,30x 59,55 cm - 46.96" x 23.45"
G-6372



Midland vison natural
59,55 x 59,55 cm - 23.45" x 23.45"
G-6224



Midland vison natural
29,75 x 59,55 cm - 11.71" x 23.45"
G-6194

Natural	CLASE 1	R9
	UNE - ENV 12633	DIN 51130
	DCOF>0.42	ANSI A 137.1 - 2012
Corrugato	CLASE 3	R11
	UNE - ENV 12633	DIN 51130

SPECIAL PIECES. PEZZI SPECIALI. PIEZAS ESPECIALES



Midland vison corrugato
29,75 x 59,55 cm - 11.71" x 23.45"
G-6234



Midland vison natural multiformato
4,84x59,55_9,72x59,55_14,75x59,55 cm
1.90"x23.45" _3.82"x23.45" _5.80"x23.45"
G-6346

* Midland mosaico 3D contains approximately 12'3 pieces/m²
* Midland mosaico 3D contiene aproximadamente 12,3 piezas/m²



Midland vison rodapié-60
7,3 x 59,55 cm - 2.87" x 23.45"
G-5091



Midland vison natural lista 60
7,3 x 59,55 cm - 2.87" x 23.45"
G-5087



MIDLAND

Midland Vison Natural 59,55x59,55 cm

MIDLAND

SPECIAL PIECES.

PEZZI SPECIALI. PIEZAS ESPECIALES

Natural	CLASE 1	R9
	UNE - ENV 12633	DIN 51130
	DCOF>0.42	
	ANSI A 137.1 - 2012	
Corrugato	CLASE 3	R11
	UNE - ENV 12633	DIN 51130



Midland grey mosaico 3D*
28,5x28,5 - 11.22" x 11.22"
G-5187



Midland grey-gold mos. 3D
28,5x28,5 - 11.22" x 11.22"
G-5211



Midland grey-silver mos. 3D
28,5x28,5 - 11.22" x 11.22"
G-5211



Midland vison mosaico 3D*
28,5x28,5 - 11.22" x 11.22"
G-5187



Midland vison-gold mos. 3D
28,5x28,5 - 11.22" x 11.22"
G-5211



Midland vison-silver mos. 3D
28,5x28,5 - 11.22" x 11.22"
G-5211



Midland grey mosaico 5x5
29,75x29,75 cm - 11.71" x 11.71"
G-6644



Midland grey mosaico 5x5
29,75x29,75 cm - 11.71" x 11.71"
G-6666



Midland vison mosaico 5x5
29,75x29,75 cm - 11.71" x 11.71"
G-6644

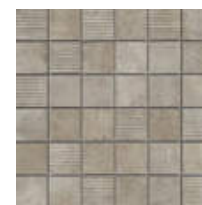

Midland vison mosaico 5x5
29,75x29,75 cm - 11.71" x 11.71"
G-6666



Midland ivory mosaico 3D*
28,5x28,5 - 11.22" x 11.22"
G-5187



Midland ivory-gold mos. 3D
28,5x28,5 - 11.22" x 11.22"
G-5211



Midland ivory-silver mos. 3D
28,5x28,5 - 11.22" x 11.22"
G-5211



Midland ivory mosaico 5x5
29,75x29,75 cm - 11.71" x 11.71"
G-6644



Midland ivory mosaico 5x5
29,75x29,75 cm - 11.71" x 11.71"
G-6666

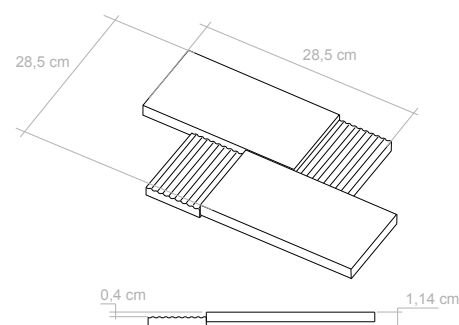

PVD Physical Vapor Deposition (PVD)

Pvd is a field in the application of nanotechnology. The process consists of depositing layers of atoms, inside a vacuum chamber, to a solid surface. The layering is produced by the condensation of a vaporized metal (such as gold, titanium, platinum etc.) over the selected surface. Advantages: High resistance to abrasion and scratches; much higher than metals applied by firing. As a general rule, any non-aggressive, pH neutral product have to be used. Do not mix pieces from different lots.

El PVD es uno de los campos de aplicación de la nanotecnología. El proceso consiste en depositar capas de átomos, en una cámara de alto vacío, sobre una superficie sólida. El recubrimiento se produce por la condensación de un metal vaporizado, oro, titanio, platino, etc, sobre el material a recubrir. Ventajas: Mayor resistencia al rayado y a la abrasión que los metales aplicados por cocción. Para la limpieza de estos materiales deben utilizarse productos no agresivos con pH neutro. No mezclar piezas de diferentes lotes.

SPECIAL PIECES.
PEZZI SPECIALI. PIEZAS ESPECIALES



Midland gold corrugato lappato

29,75 x 59,55 cm - 11.71" x 23.45"

G-5401



Midland silver corrugato lappato

29,75 x 59,55 cm - 11.71" x 23.45"

G-5401



Midland copper corrugato lappato

29,75 x 59,55 cm - 11.71" x 23.45"

G-5431

STEPS.
GRADINI.PELDAÑOS















SIMPLE 

			natural
peldaño simple-120	(60x120 cm)		5519
peldaño simple	(60x60 cm)		5281
peldaño simple-60	(30x60 cm)		5171
peldaño simple-60 Corrugato	(30x60 cm)		5171
peldaño Ang	(60x60 cm)		5299
peldaño Ang	(30x60 cm)		5187
peldaño Ang Corrugato	(30x60 cm)		5187

GRADONE 

			natural
peldaño Gradone.-120	(60x120 cm)		5795
peldaño Gradone	(60x60 cm)		5559
peldaño Gradone-60	(30x60 cm)		5559
peldaño Grad.-60 Corrugato	(30x60 cm)		5559
peldaño Grad.Ang	(60x120 cm)		5815
peldaño Grad.Ang	(60x60 cm)		5609
peldaño Grad.Ang	(30x60 cm)		5609
peldaño Grad.Ang Corrug.	(30x60 cm)		5609

TECHNICAL CHARACTERISTICS. CARATTERÍSTICAS TÉCNICAS

MEASUREMENTS AND SURFACES APPEARANCE MEDIDAS Y ASPECTO SUPERFICIAL		STANDARD TEST METHOD STANDARD TEST METHOD	STANDARD PRESCRIBED VALUES STANDARDWERTE	MIDLAND collection 7mm
	Length and width. Lunghezza e larghezza. Longitud y anchura. Länge und Breite	ISO 10545-2	± 0,6% max.	± 0,1%*
	Orthogonality. Ortogonalità. Ortogonalidad. Rechtwinkligkeit	ISO 10545-2	± 0,6% max.	± 0,2%*
	Straightness of sides. Rettilinearità dei lati. Rectitud de lados. Kantengeradigkeit	ISO 10545-2	± 0,5% max.	± 0,2%*
	Surfaces flatness. Planarità. Planitud. Ebenflächigkeit	ISO 10545-2	± 0,5% max.	± 0,2%*
PHYSICAL PROPERTIES / PROPIEDADES FÍSICAS				
	Water absorption. Assorbimento d' acqua. Absorción de agua. Wasseraufnahme	ISO 10545-3	≤ 0,5%	0,1%
	Breaking strength, in N. Carico di rottura, en N. Carga de rotura, en N. Bruchlast, in N	ISO 10545-4	≥ 700 N	1500 N*
	Modulus of rupture Resistenza alla flessione. Resistencia a la flexión. Biegefestigkeit	ISO 10545-4	≥ 35 N/mm ²	45 N/mm ² *
	Resistance to deep abrasion. Resistenza all' abrasione profonda. Resistencia a la abrasión profunda. Tiefverschleissbeständigkeit	ISO 10545-6	≤ 175 mm ³	116 mm ³ *
	Resistance to thermal shock. Resistenza agli sbalzi termici. Resistencia al choque térmico. Temperaturwechselbeständigkeit	ISO 10545-9	No surface defects should be visible Non deve presentare difetti visibili No debe presentar defectos superficiales visibles	Resistant. Resistente. Resistente
	Frost resistance. Resistenza al gelo. Resistencia a la helada. Frostbeständigkeit	ISO 10545-12	No surface defects or cracks should be visible Non deve presentare difetti visibili No debe presentar defectos ni grietas superficiales visibles	Frost Resistant Antighiaccio Resistente a la Helada
	Coefficient of friction. Resistenza allo scivolamento. Coeficiente de fricción. Rutschfestigkeit	UNE - ENV 12633	WET TEST / ENSAYO EN HÚMEDO DRY TEST / ENSAYO EN SECO	CLASE 1 ** CLASE 3 ** CLASE 3 *** DCOF - ANSIA 137.1-2012 > 42
	Colour resistance to light. Resistenza dei colori alla luce. Resistencia del color a la luz. Lichtbeständigkeit der Farben	DIN 51094	There should be no colour variations Non deve presentare difetti visibili No debe presentar variaciones de color	No alterations in colour and shine Non presenta alterazioni di colori e lucentezza No presenta variaciones de color y brillo
CHEMICAL PROPERTIES / PROPIEDADES QUÍMICAS				
	Chemical resistance. Resistenza agli agenti chimici. Resistencia química. Chemikalienbeständigkeit	ISO 10545-13	Resistance to household cleaning products and swimmingpools salts. Resistencia a productos domésticos y sales para piscinas.	Min. UB
	Resistance to staining. Resistenza alle macchie. Resistencia a las manchas. Fleckenbeständigkeit	ISO 10545-14	≥ 3	5

* The Land values are the average of different production consignments. For further detail information, please check with our commercial network.
Los valores declarados son el promedio obtenido a través de ensayos de diferentes producciones. Para la obtención de una información detallada consultar a la red comercial.
For projects check technical information with our commercial networks. / Para proyectos obtenga información técnica a través de nuestra red comercial.

** Class 1 - Tested in MIDLAND Gey Natural 30x60 (It depends on the consignment) Test realized in internal laboratory on September 2015.
Clase 1 - Sobre el MIDLAND Grey Natural 30x60 .Ensayo realizado en laboratorio interno en Septiembre 2015.
Class 3 - Tested in MIDLAND Gey Corrugato 30x60 (It depends on the consignment) Test realized in internal laboratory Grey Corrugato 30x60 on September 2015.
Clase 3 - Sobre el MIDLAND Grey Corrugato 30x60 .Ensayo realizado en laboratorio interno en Septiembre 2015.
Class 1 - Tested in MIDLAND Gey Natural 30x60 (It depends on the consignment) Test realized in internal laboratory Grey Corrugato 30x60 on October 2014.
Clase 1 - Sobre el MIDLAND Grey Natural 30x60 .Ensayo realizado en laboratorio

*** Dry Test, according to document DA DB-SUA/3 (Código Técnico de la Edificación) M^o de Fomento. Test done in MIDLAND Grey Corrugato 30x60 on October 2015.
Ensayo en seco, realizado según documento DA DB-SUA/3 (Código Técnico de la edificación) M^o de Fomento, sobre el producto MIDLAND Grey Corrugato 30x60 a fecha octubre 2015

3Dimensional

SPECIAL PIECES. PEZZI SPECIALI. PIEZAS ESPECIALES

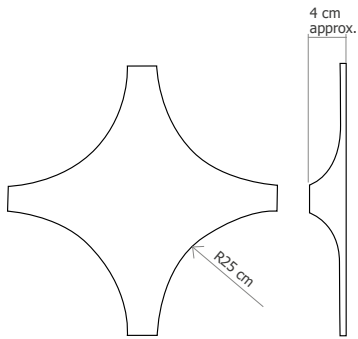

STAR*

59,55x58,88 cm

- Midland Star 59,55x58,88 cm **G-5599**

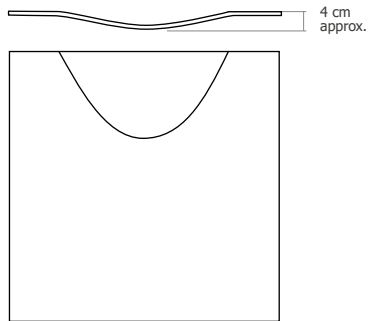

BAG*

59,55x119,30 cm / 59,55x59,55 cm / 29,75x59,55 cm

- Midland Bag 59,55x119,30 cm * **G-5735**
- Midland Bag 59,55x59,55 cm * **G-5449**
- Midland Bag 29,75x59,55 cm * **G-5299**

* Available in all colours from Midland collection.
Disponible en todos los colores de la colección Midland.

This is a natural product made through a handmade process, therefore, its possible shade or size variations must be considered as typical features of the material and they will not be admitted in a claim.

Este es un producto natural fabricado artesanalmente, por lo que posibles variaciones de tono o dimensión deben considerarse propias del material y no será objeto de reclamación.

• INFO pag. 208

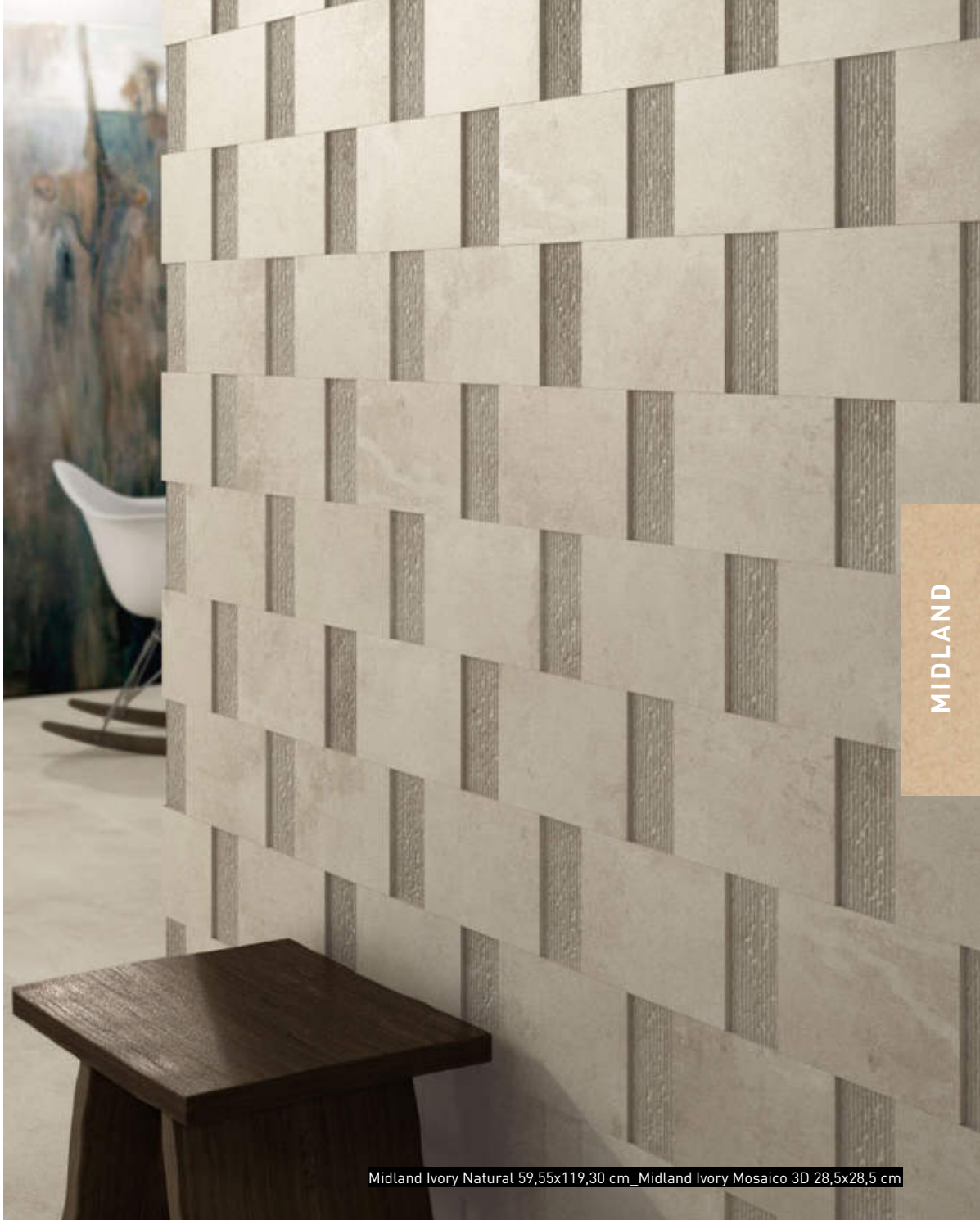

MIDLAND

Midland Ivory Natural 59,55x119,30 cm_Midland Ivory Mosaico 3D 28,5x28,5 cm

PORTLAND



CONCRETE



* Portland ivory natural. Content of recycled material.

FORMATS.FORMATI.FORMATOS

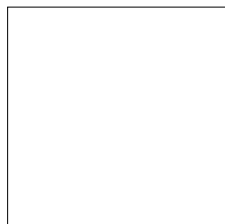

90X90
89,46x89,46 cm - 35.22"x35.22"



60X60
59,55x59,55 cm - 23.45"x23.45"

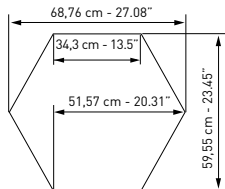

Hexagonal
59,55x51,57 cm 23.45"x20.31"



30X60
29,75x59,55 cm - 11.71"x23.45"

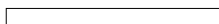

7,5X90
7,3x89,46 cm - 2.87"x35.22"

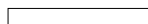

7,5X60
7,3x59,55 cm - 2.87"x23.45"

SPECIAL PIECES.PEZZI SPECIALI.PIEZAS ESPECIALES

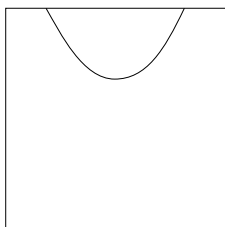

90X90 Bag*
89,46x89,46 cm - 35.22"x35.22"
60X60 Bag*
59,55x59,55 cm - 23.45"x23.45"

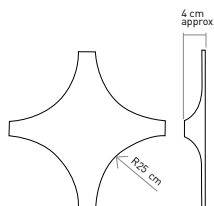

60X60 Star*
59,55x58,88 cm - 23.45"x23.18"
+ INFO pag. 210

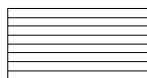

30X60 preincisión 3,5x60
29,75x59,55 cm - 11.71"x23.45"



30X30 mosaico 3,5x3,5
29,75x29,75 cm - 11.71"x11.71"



27,20X23,50 mosaico hexagonal 3D
27,20x23,50 cm - 10.71"x9.29"

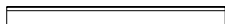

7,5X90 rodapié
7,3x89,46 cm - 2.87"x35.22"

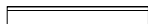

7,5X60 rodapié
7,3x59,55 cm - 2.87"x23.45"

THICKNESS.SPESORE.ESPESORES

- ≡ 1,19 cm / 0.47" approx.
- ≡ 1,03 cm / 0.40" approx.

90x90 cm FORMAT
60x60 cm / 30x60 cm FORMATS

COLOURS COLORI COLORES



Ivory



Vison



Grey

FINISHES FINITURI ACABADOS



Natural



Lappato

PORTLAND

PORTLAND ivory

PLAIN TILES.BASE.BASES



Portland ivory natural

89,46 x 89,46 cm - 35.22" x 35.22"

G-6526



Portland ivory natural listelo

7,3 x 89,46 cm - 2.87" x 35.22"

G-5155



Portland ivory natural / lappato listelo

7,3 x 59,55 cm - 2.87" x 23.45"

G-5087 / 5091

Portland lappato

CLASE 2

UNE - ENV 12633

R10

DIN 51130

Portland natural

CLASE 1

UNE - ENV 12633

DCOF>0.42

ANSI A 137.1 - 2012



Portland ivory natural / lappato

59,55 x 59,55 cm - 23.45" x 23.45"

G-6286 / 6330



Portland ivory natural / lappato

29,75 x 59,55 cm - 11.71" x 23.45"

G-6218 / 6254

COMPLEMENTS.COMPLEMENTI. COMPLEMENTOS



Byte white / moss / red / black lista 60*

1,5 x 59,55 cm - 0.59" x 23.45"

G-5100

Fusion natural lista 60*

1 x 59,55 cm - 0.39" x 23.45"

G-5049

Fusion graffiato lista 60

1,5 x 59,55 cm - 0.59" x 23.45"

G-5069

* recommended only for walls



Portland ivory lappato hexagonal

59,55 x 51,57 cm - 23.45" x 20.31"

G-6478

* 3 mm joint are recommended for hexagonal sizes.

Para formatos hexagonales se recomienda una junta de separación de 3 mm.

STEPS.GRADINI.PELDAÑOS

		natural	lappato
SIMPLE	peldaño simple-30 (30x60 cm)	5171	5171
	peldaño simple-60 (30x60 cm)	5171	5171
	peldaño simple áng. (30x60 cm)	5187	5187
	peldaño simple-60 (60x60 cm)	5281	5281
	peldaño simple áng. (60x60 cm)	5299	5299
	peldaño simple hexagonal	-	5355
GRADONE	peldaño simple 2 hexagonal	-	5281
	peldaño simple-90 (90x90 cm)	5585	-
	peldaño simple áng. (90x90 cm)	5609	-
	peldaño grad-30 (30x60 cm)	5559	5559
	peldaño grad-60 (30x60 cm)	5559	5559
	peldaño grad. áng (30x60 cm)	5609	5609
STEP	peldaño grad-60 (60x60 cm)	5559	5559
	peldaño grad. áng (60x60 cm)	5609	5609
	peldaño grad. hexagonal	-	5543
	peldaño grad. 2 hexagonal	-	5559
	peldaño grad. 90 (90x90 cm)	5779	-
	peldaño grad. áng. (90x90 cm)	5829	-
STEP	step-60 (30x60 cm)	5559	5559
	step 90 (90x90 cm)	5779	-

+ INFO pag. 207.

SPECIAL PIECES. PEZZI SPECIALI. PIEZAS ESPECIALES



Portland ivory lappato preicisión 3,5x60
29,75 x 59,55 cm - 11.71" x 23.45"
G-6486



Portland ivory natural mosaico 3,5x3,5
29,75 x 29,75 cm - 11.71" x 11.71"
G-6756

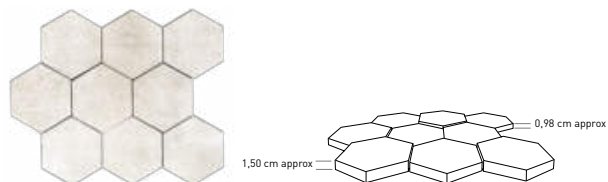

Portland ivory lappato mosaico hexagonal 3D
27,20 x 23,50 cm - 10.71" x 9.29"
G-5211



Portland ivory natural rodapié 90
7,3 x 89,46 cm - 2.87" x 35.22"
G-5163



Portland ivory natural / lappato rodapié 60
7,3 x 59,55 cm - 2.87" x 23.45"
G-5097 / G-5100



Portland Ivory Lappato Hexagonal 59,55x51,57 cm

PORTLAND grey

PLAIN TILES.BASE.BASES



Portland grey natural
89,46 x 89,46 cm - 35.22" x 35.22"
G-6526



Portland grey natural listelo
7,3 x 89,46 cm - 2.87" x 35.22"
G-5155



Portland grey natural / lappato listelo
7,3 x 59,55 cm - 2.87" x 23.45"
G-5087 / 5091

Portland lappato **CLASE 2** **R10**
UNE - ENV 12633 DIN 51130

Portland natural **CLASE 1** **DCOF>0.42**
UNE - ENV 12633 ANSI A 137.1 - 2012



Portland grey natural / lappato
59,55 x 59,55 cm - 23.45" x 23.45"
G-6286 / 6330



Portland grey natural / lappato
29,75 x 59,55 cm - 11.71" x 23.45"
G-6218 / 6254

COMPLEMENTS.COMPLEMENTI. COMPLEMENTOS



Byte white / moss / red / black lista 60*
1,5 x 59,55 cm - 0.59" x 23.45" G-5100



Fusion natural lista 60*
1 x 59,55 cm - 0.39" x 23.45" G-5049



Fusion graffiato lista 60
1,5 x 59,55 cm - 0.59" x 23.45" G-5069

* recommended only for walls



Portland grey lappato hexagonal
59,55 x 51,57 cm - 23.45" x 20.31"
G-6478

* 3 mm joint are recommended for hexagonal sizes.
Para formatos hexagonales se recomienda una junta de separación de 3 mm.

STEPS.GRADINI.PELDAÑOS

		natural	lappato
SIMPLE	peldaño simple-30 (30x60 cm)	5171	5171
	peldaño simple-60 (30x60 cm)	5171	5171
	peldaño simple áng. (30x60 cm)	5187	5187
	peldaño simple-60 (60x60 cm)	5281	5281
	peldaño simple áng. (60x60 cm)	5299	5299
	peldaño simple hexagonal	-	5355
GRADONE	peldaño simple 2 hexagonal	-	5281
	peldaño simple-90 (90x90 cm)	5585	-
	peldaño simple áng. (90x90 cm)	5609	-
	peldaño grad-30 (30x60 cm)	5559	5559
	peldaño grad-60 (30x60 cm)	5559	5559
	peldaño grad. áng (30x60 cm)	5609	5609
STEP	peldaño grad-60 (60x60 cm)	5609	5609
	peldaño grad. hexagonal	-	5543
	peldaño grad. 2 hexagonal	-	5559
	peldaño grad. 90 (90x90 cm)	5779	-
	peldaño grad. áng. (90x90 cm)	5829	-
	step-60 (30x60 cm)	5559	5559
step 90 (90x90 cm)	5779	-	

+ INFO pag. 207.

SPECIAL PIECES. PEZZI SPECIALI. PIEZAS ESPECIALES



Portland grey lappato preincisión 3,5x60
29,75 x 59,55 cm - 11.71" x 23.45"
G-6486

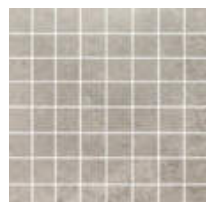

Portland grey natural mosaico 3,5x3,5
29,75 x 29,75 cm - 11.71" x 11.71"
G-6756

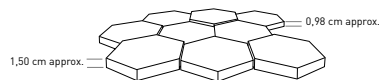

Portland grey lappato mosaico hexagonal 3D
27,20 x 23,50 cm - 10.71" x 9.29"
G-5211



Portland grey natural rodapié 90
7,3 x 89,46 cm - 2.87" x 35.22"
G-5163



Portland grey natural / lappato rodapié 60
7,3 x 59,55 cm - 2.87" x 23.45"
G-5097 / G-5100



PORTLAND **vison**

PLAIN TILES.BASE.BASES



Portland vison natural
89,46 x 89,46 cm - 35.22" x 35.22"
G-6526



Portland vison natural listelo
7,3 x 89,46 cm - 2.87" x 35.22"
G-5155



Portland vison natural / lappato listelo
7,3 x 59,55 cm - 2.87" x 23.45"
G-5087 / 5091

Portland lappato **CLASE 2** **R10**
UNE - ENV 12633 DIN 51130

Portland natural **CLASE 1** **DCOF>0.42**
UNE - ENV 12633 ANSI A 137.1 - 2012



Portland vison natural / lappato
59,55 x 59,55 cm - 23.45" x 23.45"
G-6286 / 6330



Portland vison natural / lappato
29,75 x 59,55 cm - 11.71" x 23.45"
G-6218 / 6254

COMPLEMENTS.COMPLEMENTI. COMPLEMENTOS

Byte white / moss / red / black lista 60*
1,5 x 59,55 cm - 0.59" x 23.45" G-5100

Fusion natural lista 60*
1 x 59,55 cm - 0.39" x 23.45" G-5049

Fusion graffiato lista 60
1,5 x 59,55 cm - 0.59" x 23.45" G-5069

* recommended only for walls



Portland vison lappato hexagonal
59,55 x 51,57 cm - 23.45" x 20.31"
G-6478

* 3 mm joint are recommended for hexagonal sizes.
Para formatos hexagonales se recomienda una junta de separación de 3 mm.

STEPS.GRADINI.PELDAÑOS

		natural lappato	
SIMPLE	peldaño simple-30 [30x60 cm]	5171	5171
	peldaño simple-60 [30x60 cm]	5171	5171
	peldaño simple áng. [30x60 cm]	5187	5187
	peldaño simple-60 [60x60 cm]	5281	5281
	peldaño simple áng. [60x60 cm]	5299	5299
	peldaño simple hexagonal	-	5355
GRADONE	peldaño simple 2 hexagonal	-	5281
	peldaño simple-90 [90x90 cm]	5585	-
	peldaño simple áng. [90x90 cm]	5609	-
	peldaño grad-30 [30x60 cm]	5559	5559
	peldaño grad-60 [30x60 cm]	5559	5559
	peldaño grad. áng [30x60 cm]	5609	5609
STEP	peldaño grad-60 [60x60 cm]	5559	5559
	peldaño grad. áng [60x60 cm]	5609	5609
	peldaño grad. hexagonal	-	5543
	peldaño grad. 2 hexagonal	-	5559
	peldaño grad. 90 [90x90 cm]	5779	-
	peldaño grad. áng. [90x90 cm]	5829	-
STEP	step-60 [30x60 cm]	5559	5559
	step 90 [90x90 cm]	5779	-

+ INFO pag. 207.

SPECIAL PIECES. PEZZI SPECIALI. PIEZAS ESPECIALES



Portland vison lappato preicisión 3,5x60
29,75 x 59,55 cm - 11.71" x 23.45"
G-6486



Portland vison natural mosaico 3,5x3,5
29,75 x 29,75 cm - 11.71" x 11.71"
G-6756

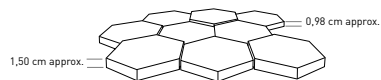

Portland vison lappato mosaico hexagonal 3D
27,20 x 23,50 cm - 10.71" x 9.29"
G-5211



Portland vison natural rodapié 90
7,3 x 89,46 cm - 2.87" x 35.22"
G-5163





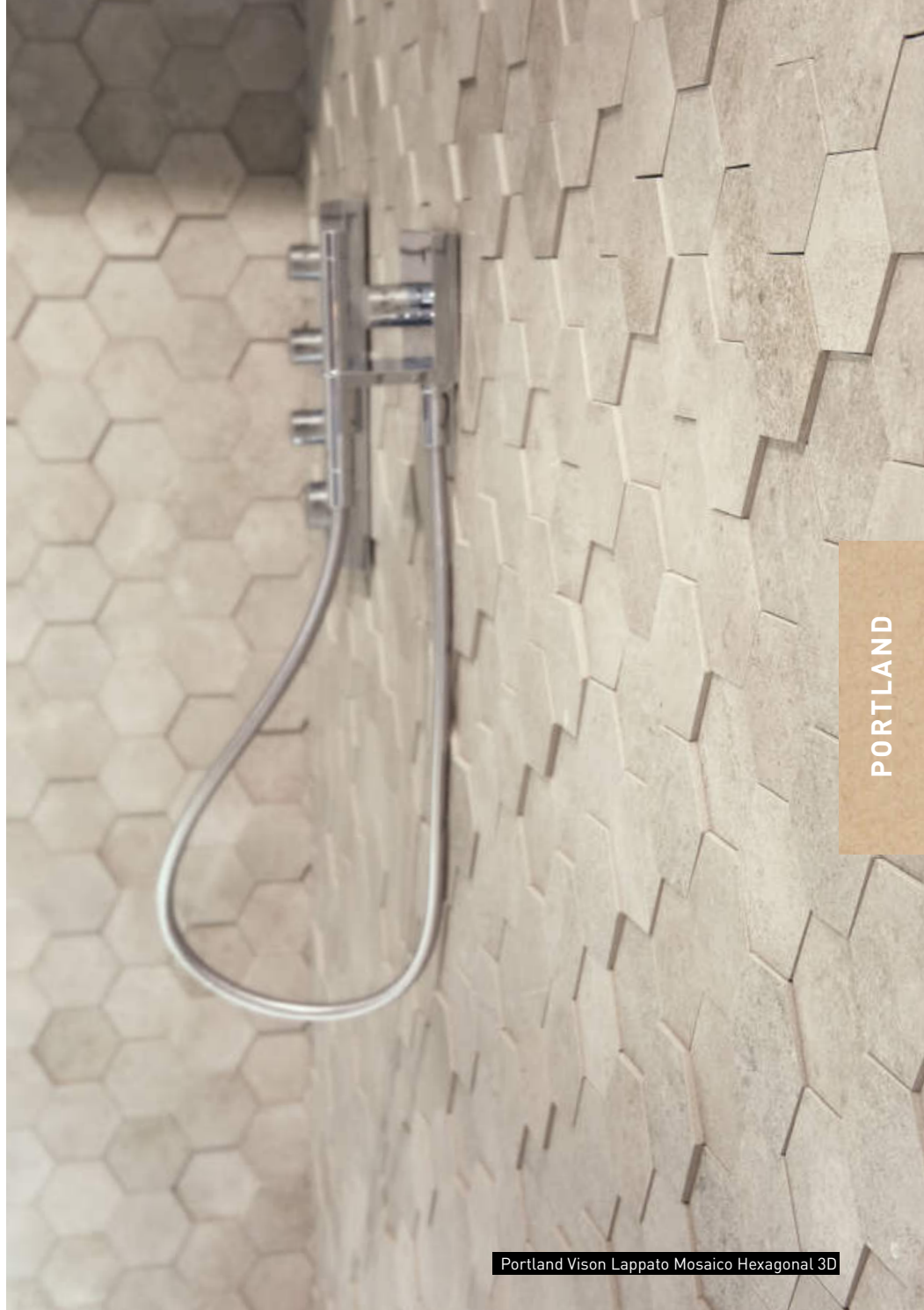











Portland vison natural / lappato rodapié 60
7,3 x 59,55 cm - 2.87" x 23.45"
G-5097 / G-5100



PORTLAND

Portland Vison Lappato Mosaico Hexagonal 3D

TECHNICAL CHARACTERISTICS. CARATTERISTICHE TECNICHE. CARACTERÍSTICAS TÉCNICAS

MEASUREMENTS AND SURFACES APPEARANCE / DIMENSIONI E ASPETTO SUPERFICIALE / MEDIDAS Y ASPECTO SUPERFICIAL / MASSEN UND AUSSEHEN DER OBERFLÄCHE		STANDARD TEST METHOD METODO DELLA NORMA METODO DE ENSAYO STANDARD TEST METHOD	STANDARD PRESCRIBED VALUES VALORE PRESCRITTO VALORES STANDARD NORMA STANDARDWERTE	PORTLAND collection *
 Length and width. <i>Lunghezza e larghezza.</i> Longitud y anchura. Länge und Breite		ISO 10545-2	± 0,6% max.	± 0,1%
 Thickness. <i>Spessore.</i> Grosor. Stärke		ISO 10545-2	± 5% max.	± 2%
 90° Orthogonality. <i>Ortogonalità.</i> Ortogonalidad. Rechtwinkligkeit		ISO 10545-2	± 0,6% max.	± 0,2%
 Straightness of sides. <i>Rettilinearità dei lati.</i> Rectitud de lados. Kantengeradigkeit		ISO 10545-2	± 0,5% max.	± 0,2%
 Surfaces flatness. <i>Planarità.</i> Planitud. Ebenföchigkeit		ISO 10545-2	± 0,5% max.	± 0,2%
PHYSICAL PROPERTIES / PROPIETÀ FISICHE / PROPIEDADES FÍSICAS / PHYSIKALISCHE EIGENSCHAFTEN				
 Water absorption. <i>Assorbimento d' acqua.</i> Absorción de agua. Wasseraufnahme		ISO 10545-3	≤ 0,5%	≤ 0,1%
 Breaking strength, in N. <i>Carico di rottura, en N.</i> Carga de rotura, en N. Bruchlast, in N	thickness > 7,5 mm spessore > 7,5 mm grosor > 7,5 mm	ISO 10545-4	≥ 1300 N	2400 N *
 Modulus of rupture. <i>Resistenza alla flessione.</i> Resistencia a la flexión. Biegefestigkeit		ISO 10545-4	≥ 35 N/mm ²	56 N/mm ² *
 Resistance to deep abrasion. <i>Resistenza all' abrasione profonda.</i> Resistencia a la abrasión profunda. Tiefverschleissbeständigkeit		ISO 10545-6	≤ 175 mm ³	115 mm ³ *
 Resistance to thermal shock. <i>Resistenza agli sbalzi termici.</i> Resistencia al choque térmico. Temperaturwechselbeständigkeit		ISO 10545-9	No surface defects should be visible Non deve presentare difetti visibili No debe presentar defectos superficiales visibles	Resistant. Resistente. Resistente
 Frost resistance. <i>Resistenza al gelo.</i> Resistencia a la helada. Frostbeständigkeit		ISO 10545-12	No surface defects or cracks should be visible Non deve presentare difetti visibili No debe presentar defectos ni grietas superficiales visibles	Frost Resistant Antighiaccio Resistente a la Helada
 Coefficient of friction. <i>Resistenza allo scivolamento.</i> Coeficiente de fricción. Rutschfestigkeit		DIN 51130 UNE - ENV 12633	WET TEST/ENSAYO EN HÚMEDO DRY TEST/ENSAYO EN SECO	R10 ** Clase 1 *** - Clase 2 **** - Clase 3***** DCOF - ANSI A 137.1-2012 > 0.42
 Colour resistance to light. <i>Resistenza dei colori alla luce.</i> Resistencia del color a la luz. Lichtbeständigkeit der Farben		DIN 51094	There should be no colour variations Non deve presentare difetti visibili No debe presentar variaciones de color	No alterations to colour and shine Non presenta alterazioni di colori e lucentezza No presenta variaciones de color y brillo
CHEMICAL PROPERTIES / PROPIETÀ CHIMICHE / PROPIEDADES QUÍMICAS / CHEMISCHEN EIGENSCHAFTEN				
 Chemical resistance. <i>Resistenza agli agenti chimici.</i> Resistencia química. Chemikalienbeständigkeit		ISO 10545-13	Resistance to household cleaning products and swimming pools salts. Resistencia a productos domésticos y sales para piscinas	Min. UB
 Resistance to staining. <i>Resistenza alle macchie.</i> Resistencia a las manchas. Fleckenbeständigkeit		ISO 10545-14	≥ 3	5

*The Land values are the average of different production consignments. For further detail information, please check with our commercial network. / I valori dichiarati sono ottenuti da una media di prove effettuate su diverse produzioni. Per avere informazioni dettagliate consultare la rete commerciale / Los valores declarados son el promedio obtenido a través de ensayos de diferentes producciones. Para la obtención de una información detallada consultar a la red comercial.

** R10 - Test done in PORTLAND GREY LAPPATO 30x60 on September 2011. (batch 07-09-2011)

*** Clase 1 - Tested in natural finish (It depends on the consignment) Test realized in internal laboratory / Provare realizzato in laboratorio interno / Ensayo realizado en laboratorio interno.

**** Clase 2 - Tested in lappato finish (It depends on the consignment) Test realized in internal laboratory / Provare realizzato in laboratorio interno / Ensayo realizado en laboratorio interno.

***** Dry Test, according to document DA DB-SUA/3 (Código Técnico de la Edificación) M° de Fomento. Test done in PORTLAND GREY NATURAL 30x60 on May 2012.

Ensayo realizado, según documento DA DB-SUA/3 (Código Técnico de la edificación) M° de Fomento, sobre el producto PORTLAND GREY NATURAL 30x60 a fecha Mayo 2012.

3Dimensional

SPECIAL PIECES. PEZZI SPECIALI. PIEZAS ESPECIALES

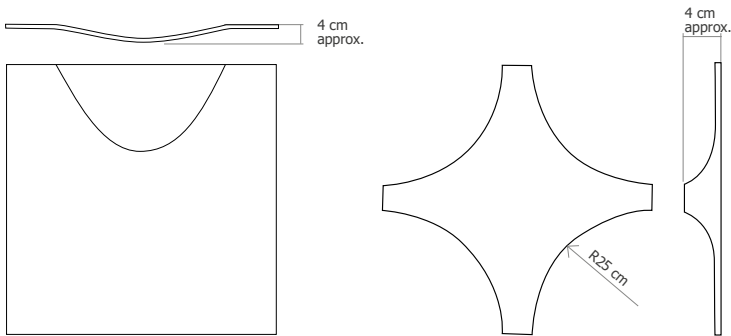

BAG*

89,46 X 89,46 cm / 59,55x59,55 cm

- Portland Bag 89,46x89,46 cm **G-5795**
- Portland Bag 59,55x59,55 cm **G-5449**

STAR*

59,55x58,88 cm

- Portland Star 59,55x58,88 cm **G-5499**

* Available in all colours from Portland collection.
Disponible en todos los colores de la colección Portland.

This is a natural product made through a handmade process, therefore, its possible shade or size variations must be considered as typical features of the material and they will not be admitted in a claim.

Este es un producto natural fabricado artesanalmente, por lo que posibles variaciones de tono o dimension deben considerarse propias del material y no será objeto de reclamación.

+ INFO pag. 208



PORTLAND

Portland Grey Natural Bag 89,46x89,46 cm

PORTLAND SLIM



CONCRETE

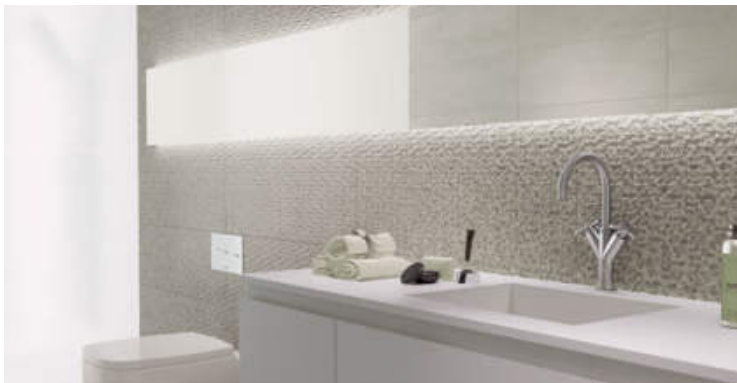

* Portland slim ivory natural. Content of recycled material.

FORMATS.FORMATI.FORMATOS



30X90 natural
29,75x89,46 cm - 11.71"x35.22"



30X90 hexagon
29,75x89,46 cm - 11.71"x35.22"

SPECIAL PIECES.PEZZI SPECIALI.PIEZAS ESPECIALES



30X30 mosaico 2,5x2,5
29,75x29,75 cm - 11.71"x11.71"

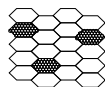

30X30 mosaico hexagonal 6x7,5
29,75x29,75 cm - 11.71"x11.71"

THICKNESS.SPESSORE.ESPESORES

 0,48 cm approx. / 0.19" approx.

COLOURS COLORI COLORES



Ivory



Vison



Grey

FINISHES FINITURI ACABADOS



Natural

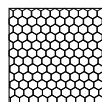

Hexagon

PORTLAND SLIM

PORTLAND SLIM ivory

PLAIN TILES.BASE.BASES



Portland slim ivory natural
29,75 x 89,46 cm - 11.71" x 35.22"
G-6224



Portland slim ivory hexagon
29,75 x 89,46 cm - 11.71" x 35.22"
G-6246

SPECIAL PIECES.PEZZI SPECIALI.PIEZAS ESPECIALES

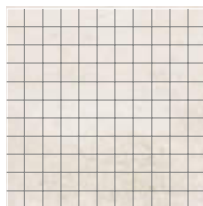

**Portland slim ivory natural
mosaico 2,5x2,5**
29,75 x 29,75 cm - 11.71" x 11.71"
G-6756



**Portland slim ivory
mosaico hexagonal 6x7,5***
29,75 x 29,75 cm - 11.71" x 11.71"
G-6796

* The three hexagonal tesserae change pattern randomly.
Las tres teselas hexagon cambian de posición aleatoriamente.

COMPLEMENTS.COMPLEMENTI.COMPLEMENTOS

Fusion graffiato lista 90
1,5 x 89,46 cm - 0.59" x 35.22"



G-5091



PORTLAND SLIM

wall: Portland Slim Ivory Hexagon_Grey Natural 29,75x89,46 cm floor: Portland Ivory Natural 89,46x89,46 cm

PORTLAND SLIM grey

PLAIN TILES.BASE.BASES



Portland slim grey natural
29,75 x 89,46 cm - 11.71" x 35.22"
G-6224

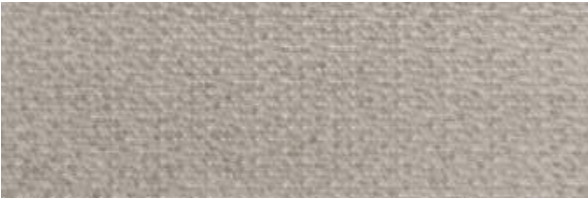

Portland slim grey hexagon
29,75 x 89,46 cm - 11.71" x 35.22"
G-6246

SPECIAL PIECES.PEZZI SPECIALI.PIEZAS ESPECIALES

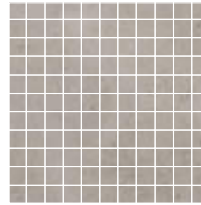

**Portland slim grey natural
mosaico 2,5x2,5**
29,75 x 29,75 cm - 11.71" x 11.71"
G-6756



**Portland slim grey
mosaico hexagonal 6x7,5***
29,75 x 29,75 cm - 11.71" x 11.71"
G-6796

* The three hexagonal tesserae change pattern randomly.
Las tres teselas hexagon cambian de posición aleatoriamente.

COMPLEMENTS.COMPLEMENTI.COMPLEMENTOS

Fusion graffiato lista 90
1,5 x 89,46 cm - 0.59" x 35.22"



G-5091



PORTLAND SLIM

wall: Portland Slim Grey Hexagon_Grey Natural 29,75x89,46 cm floor: Portland Grey Lappato Hexagonal

PORTLAND SLIM **vison**

PLAIN TILES.BASE.BASES



Portland slim vison natural

29,75 x 89,46 cm - 11.71" x 35.22"

G-6224



Portland slim vison hexagon

29,75 x 89,46 cm - 11.71" x 35.22"

G-6246

SPECIAL PIECES.PEZZI SPECIALI.PIEZAS ESPECIALES

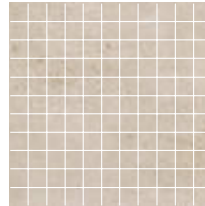

Portland slim vison natural mosaico 2,5x2,5

29,75 x 29,75 cm - 11.71" x 11.71"

G-6756



Portland slim vison mosaico hexagonal 6x7,5*

29,75 x 29,75 cm - 11.71" x 11.71"

G-6796

* The three hexagonal tesserae change pattern randomly.
Las tres teselas hexagon cambian de posición aleatoriamente.

COMPLEMENTS.COMPLEMENTI.COMPLEMENTOS

Fusion graffiato lista 90

1,5 x 89,46 cm - 0.59" x 35.22"



G-5091



PORTLAND SLIM

wall: Portland Slim Vison Hexagon_ Ivory Hexagon_ Vison Natural 29,75x89,46 cm floor: Portland Visón Natural 89,46x89,46 cm

TECHNICAL CHARACTERISTICS. CARATTERISTICHE TECNICHE. CARACTERÍSTICAS TÉCNICAS

MEASUREMENTS AND SURFACES APPEARANCE / DIMENSIONI E ASPETTO SUPERFICIALE / MEDIDAS Y ASPECTO SUPERFICIAL / MASEN UND AUSSEHEN DER OBERFLÄCHE		STANDARD TEST METHOD METODO DELLA NORMA METODO DE ENSAYO STANDARD TEST METHOD	STANDARD PRESCRIBED VALUES VALORE PRESCRITTO VALORES STANDARD NORMA STANDARDWERTE	Portland Slim *
Length and width. <i>Lunghezza e larghezza.</i> Longitud y anchura. Länge und Breite		ISO 10545-2	± 0,6% max.	± 0,1% *
Orthogonality. <i>Ortogonalità.</i> Ortogonalidad. Rechtwinkligkeit		ISO 10545-2	± 0,6% max.	± 0,2% *
Straightness of sides. <i>Rettilinearità dei lati.</i> Rectitud de lados. Kantengeradigkeit		ISO 10545-2	± 0,5% max.	± 0,2% *
Surfaces flatness. <i>Planarità.</i> Planitud. Ebenföchigkeit		ISO 10545-2	± 0,5% max.	± 0,2% *
PHYSICAL PROPERTIES / PROPIETÀ FISICHE / PROPIEDADES FÍSICAS / PHYSIKALISCHE EIGENSCHAFTEN				
Water absorption. <i>Assorbimento d'acqua.</i> Absorción de agua. Wasseraufnahme		ISO 10545-3	≤ 0,5%	0,1%
Breaking strength, in N. <i>Carico di rottura, en N.</i> Carga de rotura, en N. Bruchlast, in N	thickness <75 mm spessore <7,5 mm grosor <7,5 mm	ISO 10545-4	≥ 700 N	Available Method * Metodo Disponibile Método Disponible
Modulus of rupture. <i>Resistenza alla flessione.</i> Resistencia a la flexión. Biegefestigkeit		ISO 10545-4	≥ 35 N/mm ²	>40 N/mm ² *
Resistance to thermal shock. <i>Resistenza agli sbalzi termici.</i> Resistencia al choque térmico. Temperaturwechselbeständigkeit		ISO 10545-9	No surface defects should be visible Non deve presentare difetti visibili No debe presentar defectos superficiales visibles	Resistant. Resistente. Resistente
Frost resistance. <i>Resistenza al gelo.</i> Resistencia a la helada. Frostbeständigkeit		ISO 10545-12	No surface defects or cracks should be visible Non deve presentare difetti visibili No debe presentar defectos ni grietas superficiales visibles	Frost Resistant Antighaccio Resistente a la Helada
Coefficient of friction. <i>Resistenza allo scivolamento.</i> Coeficiente de fricción. Rutschfestigkeit		DIN 51130		Available Method Metodo Disponibile Método Disponible
Colour resistance to light. <i>Resistenza dei colori alla luce.</i> Resistencia del color a la luz. Lichtbeständigkeit der Farben		DIN 51094	There should be no colour variations Non deve presentare difetti visibili No debe presentar variaciones de color	No alterations in colour and shine Non presenta alterazioni di colori e lucentezza No presenta variaciones de color y brillo
CHEMICAL PROPERTIES / PROPIETÀ CHIMICHE / PROPIEDADES QUÍMICAS / CHEMISCHEN EIGENSCHAFTEN				
Chemical resistance. <i>Resistenza agli agenti chimici.</i> Resistencia química. Chemikalienbeständigkeit		ISO 10545-13	Resistance to household cleaning products and swimmingpools salts. Resistencia a productos domésticos y sales para piscinas	Min. GB
Resistance to staining. <i>Resistenza alle macchie.</i> Resistencia a las manchas. Fleckenbeständigkeit		ISO 10545-14	≥ 3	5 *

*The Land values are the average of different production consignments. For further detail information, please check with our commercial network. / I valori dichiarati sono ottenuti da una media di prove effettuate su diverse produzioni. Per avere informazioni dettagliate consultare la rete commerciale / Los valores declarados son el promedio obtenido a través de ensayos de diferentes producciones. Para la obtención de una información detallada consultar a la red comercial.

ADVANTAGES. VANTAGGI. VENTAJAS

- Time. *Tempo.* Tiempo
- Money. *Denaro.* Dinero
- Hygiene. *Igiene.* Higiene
- Ecologic. *Ecologia.* Ecología
- Technology. *Tecnologia.* Tecnología

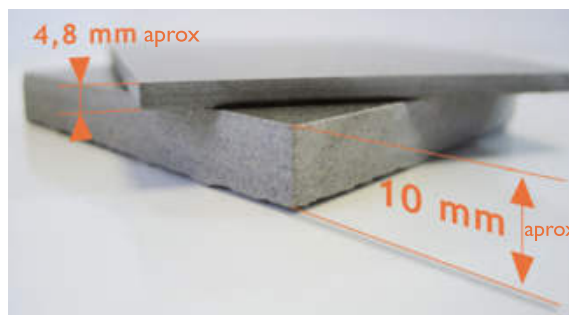

* Recommended only for wall. / sólo recomendado como revestimiento.



PORTLAND SLIM

wall: Portland Slim Grey Hexagon 29,75x89,46 cm

CIVIC



CONCRETE



SHOWROOM RIMADESIO
Madrid. (SPAIN)
Arch. INZENSO Estudio



PRIVATE HOUSE
Messelbroek. (BELGIUM)

* Civic grey natural. Content of recycled material. Contenido de material reciclado.

FORMATS.FORMATI.FORMATOS

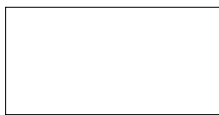

45X90
44,63x89,46 cm - 17.57"x35.22"

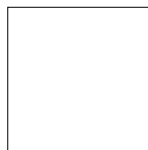

60X60
59,55x59,55 cm
23.45"x23.45"



22,5X90
22,21x89,46 cm - 8.75"x35.22"



30X60
29,75x59,55 cm - 11.71"x23.45"



7,5X90
7,3x89,46 cm - 2.87"x35.22"



7,5X60
7,3x59,55 cm - 2.87"x23.45"

SPECIAL PIECES.PEZZI SPECIALI.PIEZAS ESPECIALES

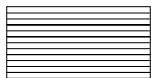

30X60 preincisión 2,5x60
29,75x59,55 cm - 11.71"x23.45"



30X30 multicolor
29,75x29,75 cm - 11.71"x11.71"



30X30 mosaico ice / steel 2,5x2,5
29,75x29,75 cm - 11.71"x11.71"



30X30 mosaico 2,5x2,5
29,75x29,75 cm - 11.71"x11.71"



7,5X60 rodapié
7,2x59,55 cm - 2.83"x23.45"



7,5X45 rodapié
7,2x44,63 cm - 2.83"x17.57"

THICKNESS.SPESSORE.ESPESORES

- ≡ 1,11 cm / 0.44" approx.
- ≡ 1,03 cm / 0.40" approx.

45x90 cm / 22,5x90 cm FORMATS
30x60 cm / 60x60 cm FORMATS

COLOURS COLORI COLORES



Ivory



Grey



Antracita

FINISHES FINITURI ACABADOS



Natural

CIVIC ivory

PLAIN TILES.BASE.BASES



Civic ivory natural
44,63 x 89,46 cm - 17.57" x 35.22"
G-6410



Civic ivory natural
22,21 x 89,46 cm - 8.75" x 35.22"
G-6456



Civic ivory natural
59,55 x 59,55 cm - 23.45" x 23.45"
G-6410



Civic ivory natural
29,75 x 59,55 cm - 11.71" x 23.45"
G-6298

SPECIAL PIECES.PEZZI SPECIALI.PIEZAS ESPECIALES



Civic ivory natural preincisión 2,5x60
29,75 x 59,55 cm - 11.71" x 23.45"
G-6486

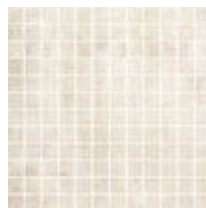

Civic ivory natural mosaico 2,5x2,5
29,75 x 29,75 cm - 11.71" x 11.71"
G-6756

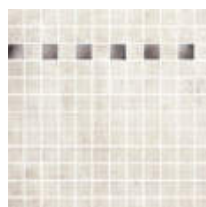

Civic ivory natural mosaico steel 2,5x2,5
29,75 x 29,75 cm - 11.71" x 11.71"
G-6844

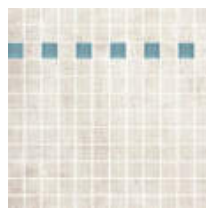

Civic ivory natural mosaico ice 2,5x2,5
29,75 x 29,75 cm - 11.71" x 11.71"
G-6844



Civic multicolor natural
29,75 x 29,75 cm - 11.71" x 11.71"
G-5149



Civic ivory natural listelo 90
7,3 x 89,46 cm - 2.87" x 35.22"
G-5119



Civic ivory natural listelo 60
7,3 x 59,55 cm - 2.87" x 23.45"
G-5091



Civic ivory natural rodapié 60
7,3 x 59,55 cm - 2.87" x 23.45"
G-5097



Civic ivory natural rodapié 45
7,3 x 44,63 cm - 2.87" x 17.57"
G-5087



Civic ivory natural rodapié 30
7,3 x 29,75 cm - 2.87" x 11.71"
G-5075

STEPS.GRADINI.PELDAÑOS

SIMPLE

pedaño simple-30 (30x60 cm)	5195
pedaño simple-60 (30x60 cm)	5195
pedaño simple áng. (30x60 cm)	5211
pedaño simple-60 (60x60 cm)	5281
pedaño simple ang (60x60 cm)	5299
pedaño simple-90 (45x90 cm)	5333
pedaño simple áng. (45x90 cm)	5345

GRADONE

pedaño grad-30 (30x60 cm)	5559
pedaño grad-60 (30x60 cm)	5559
pedaño grad áng. (30x60 cm)	5609
pedaño grad-60 (60x60 cm)	5585
pedaño grad áng. (60x60 cm)	5633
pedaño grad-90 (45x90 cm)	5623
pedaño grad áng. (45x90 cm)	5645

+ INFO pag. 207.

COMPLEMENTS.COMPLEMENTI.COMPLEMENTOS



Byte white / ice / yellow / orange / red / purple / blue / grey / moss / black lista 90*
2 x 89,46 cm - 0.79" x 35.22"
G-5173

Fusion graffiato lista 90
1,5 x 89,46 cm - 0.59" x 35.22"
G-5091

Byte ice / yellow / red / black lista 60*
1,5 x 59,55 cm - 0.59" x 23.45"
G-5100

Fusion natural lista 60*
1 x 59,55 cm - 0.39" x 23.45"
G-5049

Fusion graffiato lista 60
1,5 x 59,55 cm - 0.59" x 23.45"
G-5069

* recommended only for walls



Civic grey natural
44,63 x 89,46 cm - 17.57" x 35.22"
G-6372



Civic grey natural
22,21 x 89,46 cm - 8.75" x 35.22"
G-6426



Civic grey natural
59,55 x 59,55 cm - 23.45" x 23.45"
G-6372



Civic grey natural
29,75 x 59,55 cm - 11.71" x 23.45"
G-6258

SPECIAL PIECES.PEZZI SPECIALI.PIEZAS ESPECIALES



Civic grey natural preincisión 2,5x60
29,75 x 59,55 cm - 11.71" x 23.45"
G-6486

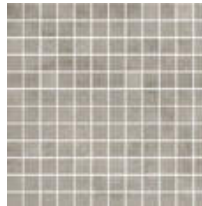

Civic grey natural mosaico 2,5x2,5
29,75 x 29,75 cm - 11.71" x 11.71"
G-6756

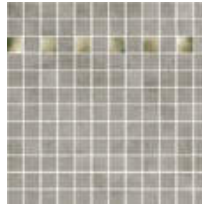

Civic grey natural mosaico steel 2,5x2,5
29,75 x 29,75 cm - 11.71" x 11.71"
G-6844

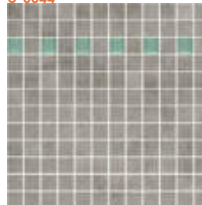

Civic grey natural mosaico ice 2,5x2,5
29,75 x 29,75 cm - 11.71" x 11.71"
G-6844



Civic multicolor natural
29,75 x 29,75 cm - 11.71" x 11.71"
G-5149



Civic grey natural listelo 90
7,3 x 89,46 cm - 2.87" x 35.22"
G-5119



Civic grey natural listelo 60
7,3 x 59,55 cm - 2.87" x 23.45"
G-5091



Civic grey natural rodapié 60
7,3 x 59,55 cm - 2.87" x 23.45"
G-5097



Civic grey natural rodapié 45
7,3 x 44,63 cm - 2.87" x 17.57"
G-5087



Civic grey natural rodapié 30
7,3 x 29,75 cm - 2.87" x 11.71"
G-5075

STEPS.GRADINI.PELDAÑOS

SIMPLE



pedaño simple-30 (30x60 cm)	5171
pedaño simple-60 (30x60 cm)	5171
pedaño simple áng. (30x60 cm)	5187
pedaño simple-60 (60x60 cm)	5881
pedaño simple áng. (60x60 cm)	5299
pedaño simple-90 (45x90 cm)	5323
pedaño simple áng. (45x90 cm)	5333

GRADONE



pedaño grad-30 (30x60 cm)	5559
pedaño grad-60 (30x60 cm)	5559
pedaño grad áng. (30x60 cm)	5609
pedaño grad-60 (60x60 cm)	5585
pedaño grad áng. (60x60 cm)	5633
pedaño grad-90 (45x90 cm)	5623
pedaño grad áng. (45x90 cm)	5645

+ INFO pag. 207.

Civic natural **CLASE 1**
UNE - ENV 12633

The material reproduces the look of concrete through its smooth relieves and the uneven color tones of its pieces.
Il prodotto crea l'effetto del calcestruzzo tramite la stonalizzazione e il leggero rilievo dei singoli pezzi.
El producto reproduce la apariencia del hormigón con la destonificación y el suave relieve de las piezas.



Civic antracita natural
44,63 x 89,46 cm - 17.57" x 35.22"
G-6372



Civic antracita natural
22,21 x 89,46 cm - 8.75" x 35.22"
G-6426

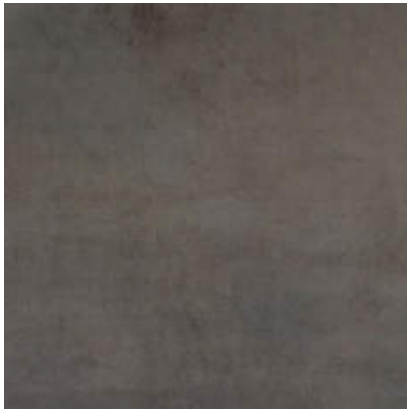

Civic antracita natural
59,55 x 59,55 cm - 23.45" x 23.45"
G-6372

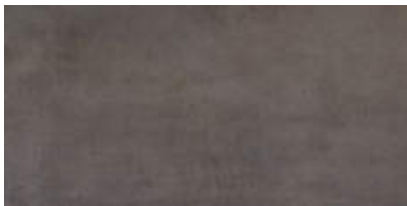

Civic antracita natural
29,75 x 59,55 cm - 11.71" x 23.45"
G-6258

SPECIAL PIECES.PEZZI SPECIALI.PIEZAS ESPECIALES



Civic antracita natural preincisión 2,5x60
29,75 x 59,55 cm - 11.71" x 23.45"
G-6486

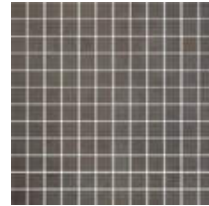

Civic antracita natural mosaico 2,5x2,5
29,75 x 29,75 cm - 11.71" x 11.71"
G-6756

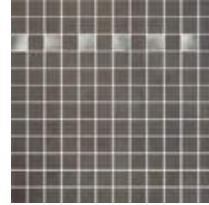

Civic antracita natural mosaico steel 2,5x2,5
29,75 x 29,75 cm - 11.71" x 11.71"
G-6844

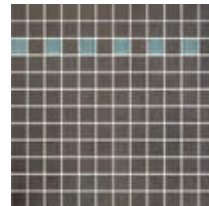

Civic antracita natural mosaico ice 2,5x2,5
29,75 x 29,75 cm - 11.71" x 11.71"
G-6844



Civic multicolor natural
29,75 x 29,75 cm - 11.71" x 11.71"
G-5149



Civic antracita natural listelo 90
7,3 x 89,46 cm - 2.87" x 35.22"
G-5119



Civic antracita natural listelo 60
7,3 x 59,55 cm - 2.87" x 23.45"
G-5091



Civic antracita natural rodapié 60
7,3 x 59,55 cm - 2.87" x 23.45"
G-5097



Civic antracita natural rodapié 45
7,3 x 44,63 cm - 2.87" x 17.57"
G-5087



Civic antracita natural rodapié 30
7,3 x 29,75 cm - 2.87" x 11.71"
G-5075

STEPS.GRADINI.PELDAÑOS

SIMPLE	GRADONE
peldaño simple-30 (30x60 cm) 5171	peldaño grad-30 (30x60 cm) 5559
peldaño simple-60 (30x60 cm) 5171	peldaño grad-60 (30x60 cm) 5559
peldaño simple áng. (30x60 cm) 5187	peldaño grad áng. (30x60 cm) 5609
peldaño simple-60 (60x60 cm) 5281	peldaño grad-60 (60x60 cm) 5585
peldaño simple ang (60x60 cm) 5299	peldaño grad áng. (60x60 cm) 5633
peldaño simple-90 (45x90 cm) 5323	peldaño grad-90 (45x90 cm) 5707
peldaño simple áng. (45x90 cm) 5645	peldaño grad áng. (45x90 cm) 5723

+ INFO pag. 207.

COMPLEMENTS.COMPLEMENTI.COMPLEMENTOS



Byte white / ice / yellow / orange / red / purple / blue / grey / moss / black lista 90*
2 x 89,46 cm - 0.79" x 35.22"
G-5173

Fusion graffiato lista 90
1,5 x 89,46 cm - 0.59" x 35.22"
G-5091

Byte ice / yellow / red / black lista 60*
1,5 x 59,55 cm - 0.59" x 23.45"
G-5100

Fusion natural lista 60*
1 x 59,55 cm - 0.39" x 23.45"
G-5049

Fusion graffiato lista 60
1,5 x 59,55 cm - 0.59" x 23.45"
G-5069

* recommended only for walls

















Civic Grey Natural_Antracita Natural_Ivory Natural 29,75x59,55 cm

AIRPORT FACILITIES
Palma de Mallorca. (SPAIN)

CIVIC



TECHNICAL CHARACTERISTICS. CARATTERISTICHE TECNICHE. CARACTERÍSTICAS TÉCNICAS

MEASUREMENTS AND SURFACES APPEARANCE / DIMENSIONI E ASPETTO SUPERFICIALE / MEDIDAS Y ASPECTO SUPERFICIAL / MASSEN UND AUSSEHEN DER OBERFLÄCHE		STANDARD TEST METHOD METODO DELLA NORMA METODO DE ENSAYO STANDARD TEST METHOD	STANDARD PRESCRIBED VALUES VALORE PRESCRITTO VALORES STANDARD NORMA STANDARDWERTE	CIVIC collection *
 Length and width. <i>Lunghezza e larghezza.</i> Longitud y anchura. Länge und Breite		ISO 10545-2	± 0,6% max.	± 0,1%
 Thickness. <i>Spessore.</i> Grosor. Stärke		ISO 10545-2	± 5% max.	± 2%
 90° Orthogonality. <i>Ortogonalità.</i> Ortogonalidad. Rechtwinkligkeit		ISO 10545-2	± 0,6% max.	± 0,2%
 Straightness of sides. <i>Rettilinearità dei lati.</i> Rectitud de lados. Kantengeradigkeit		ISO 10545-2	± 0,5% max.	± 0,2%
 Surfaces flatness. <i>Planarità.</i> Planitud. Ebenföchigkeit		ISO 10545-2	± 0,5% max.	± 0,2%
PHYSICAL PROPERTIES / PROPIETÀ FISICHE / PROPIEDADES FÍSICAS / PHYSIKALISCHE EIGENSCHAFTEN				
 Water absorption. <i>Assorbimento d' acqua.</i> Absorción de agua. Wasseraufnahme		ISO 10545-3	≤ 0,5%	≤ 0,1%
 Breaking strength, in N. <i>Carico di rottura, en N.</i> Carga de rotura, en N. Bruchlast, in N	thickness > 7,5 mm spessore > 7,5 mm grosor > 7,5 mm	ISO 10545-4	≥ 1300 N	2400 N*
 Modulus of rupture. <i>Resistenza alla flessione.</i> Resistencia a la flexión. Biegefestigkeit		ISO 10545-4	≥ 35 N/mm ²	60 N/mm ² **
 Resistance to deep abrasion. <i>Resistenza all' abrasione profonda.</i> Resistencia a la abrasión profunda. Tiefverschleissbeständigkeit		ISO 10545-6	≤ 175 mm ³	128 mm ³ **
 Resistance to thermal shock. <i>Resistenza agli sbalzi termici.</i> Resistencia al choque térmico. Temperaturwechselbeständigkeit		ISO 10545-9	No surface defects should be visible <i>Non deve presentare difetti visibili</i> No debe presentar defectos superficiales visibles	Resistant. Resistente. Resistente
 Frost resistance. <i>Resistenza al gelo.</i> Resistencia a la helada. Frostbeständigkeit		ISO 10545-12	No surface defects or cracks should be visible <i>Non deve presentare difetti visibili</i> No debe presentar defectos ni grietas superficiales visibles	Frost Resistant <i>Antighaccio</i> Resistente a la Helada
 Coefficient of friction. <i>Resistenza allo scivolamento.</i> Coeficiente de fricción. Rutschfestigkeit		UNE - ENV 12633	WET TEST/ENSAYO EN HÚMEDO DRY TEST/ENSAYO EN SECO	Clase 1*** Clase 3****
 Colour resistance to light. <i>Resistenza dei colori alla luce.</i> Resistencia del color a la luz. Lichtbeständigkeit der Farben		DIN 51094	There should be no colour variations <i>Non deve presentare difetti visibili</i> No debe presentar variaciones de color	No alterations to colour and shine <i>Non presenta alterazioni di colori e lucentezza</i> No presenta variaciones de color y brillo
CHEMICAL PROPERTIES / PROPIETÀ CHIMICHE / PROPIEDADES QUÍMICAS / CHEMISCHEN EIGENSCHAFTEN				
 Chemical resistance. <i>Resistenza agli agenti chimici.</i> Resistencia química. Chemikalienbeständigkeit		ISO 10545-13	Resistance to household cleaning products and swimmingpools salts. <i>Resistencia a productos domésticos y sales para piscinas</i>	Min. UB
 Resistance to staining. <i>Resistenza alle macchie.</i> Resistencia a las manchas. Fleckenbeständigkeit		ISO 10545-14	≥ 3	5

*The Land values are the average of different production consignments. For further detail information, please check with our commercial network. / I valori dichiarati sono ottenuti da una media di prove effettuate su diverse produzioni. Per avere informazioni dettagliate consultare la rete commerciale / Los valores declarados son el promedio obtenido a través de ensayos de diferentes producciones. Para la obtención de una información detallada consultar a la red comercial.

** Test realized in Civic Grey 45x90. Provare realizzato in Civic Grey 45x90. Ensayo realizado en Civic Grey 45x90.

*** Test realized in internal laboratory. Provare realizzato in laboratorio interno. Ensayo realizado en laboratorio interno.

**** Dry Test, according to document DA DB-SUA/3 (Código Técnico de la Edificación) M° de Fomento. Average test result value, on May 2012. Ensayo realizado, según documento DA DB-SUA/3 (Código Técnico de la edificación) M° de Fomento, valor medio a fecha Mayo 2012.



CIVIC

Civic Grey Natural 59,55x59,55 cm

ALLENDE ARCHITECTS OFFICE
Madrid. (SPAIN)
Arch. MANUEL MALLO - LUIS DE PEREDA

KANKARE



STONE



* Kankare ivory natural. Content of recycled material.

FORMATS.FORMATI.FORMATOS

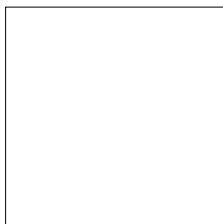

90X90
89,46x89,46 cm - 35.22"x35.22"

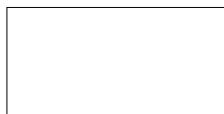

45X90
44,63x89,46 cm - 17.61"x35.22"



7,5X90
7,3x89,46 cm - 2.87"x35.22"



7,5X45
7,3x44,63 cm - 2.87"x17.61"

SPECIAL PIECES.PEZZI SPECIALI.PIEZAS ESPECIALES

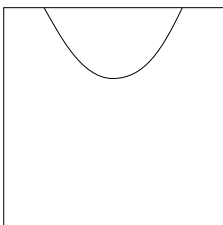

90X90 Bag*
89,46x89,46 cm - 35.22"x35.22"
45X90 Bag*
44,63 x 89,46 cm - 17.57" x 35.22"
+ INFO pag. 210

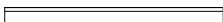

7,5X90 rodapié
7,3x89,46 cm - 2.87"x35.22"



45X90 Lines
44,63x89,46 cm - 17.61"x35.22"



45X90 Rubic
44,63x89,46 cm - 17.61"x35.22"



30X30 mosaico 3,5x3,5
29,75x29,75 cm - 11.71"x11.71"



7,5X45 rodapié
7,3x44,63 cm - 2.87" x 17.61"



15X90 Chevron
14,77x89,46 cm - 17.61"x35.22"

THICKNESS.SPESSORE.ESPEORES

≡ 0,74 cm / 0,27" approx.

COLOURS COLORI COLORES



Ivory



Vison



Grey

FINISHES FINITURI ACABADOS

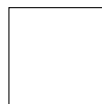

Natural



Non-slip

PLAIN TILES. BASE. BASES



Kankare ivory natural

89,46 x 89,46 cm - 35.22" x 35.22"

G-6372



Kankare ivory natural / Kankare ivory natural non-slip

44,63 x 89,46 cm - 17.57" x 35.22"

G-6224 / G-6246



Kankare ivory cenefa 3 natural

14,70 x 89,46cm - 5.90" x 35.22"

G-6330

SPECIAL PIECES. PEZZI SPECIALI. PIEZAS ESPECIALES



Kankare ivory lines natural

44,63 x 89,46 cm - 17.57" x 35.22"

G-6250

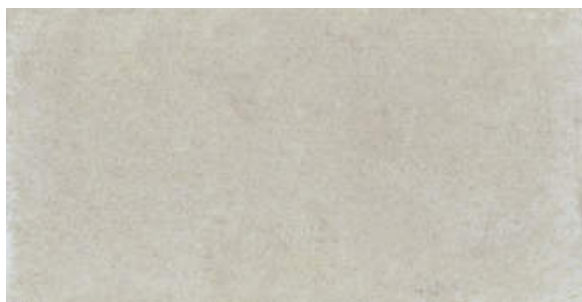

Kankare ivory rubic natural

44,63 x 89,46 cm - 17.57" x 35.22"

G-6250



Kankare ivory natural rodapié 90

7,3 x 89,46 cm - 2.87" x 35.22"

G-5125



Kankare ivory natural rodapié 45

7,3 x 44,63 cm - 2.87" x 17.57"

G-5085

natural **CLASE 1** **R9**
UNE - ENV 12633 DIN 51130

DCOF>0.42
ANSI A 137.1 - 2012

non-slip **CLASE 3** **R10**
UNE - ENV 12633 DIN 51130

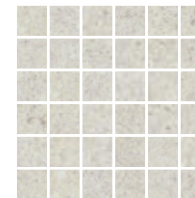

Kankare ivory natural mosaico 3,5x3,5

29,75 x 29,75 cm - 11.71" x 11.71"

G-6644

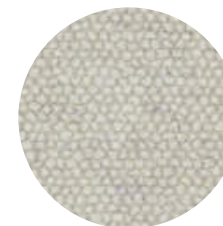

* DETAIL. Kankare ivory rubic natural
* DETALLE. Kankare ivory rubic natural

STEPS. GRADINI. PELDAÑOS

SIMPLE

GRADONE

		natural
SIMPLE	peldaño simple-45 (45x90 cm)	5305
	peldaño simple-90 (90x90 cm)	5585
	peldaño simple áng. (45x90 cm)	5315
	peldaño simple áng. (90x90 cm)	5609
GRADONE	peldaño grad-45 (45x90 cm)	5603
	peldaño grad-90 (90x90 cm)	5779
	peldaño grad. áng. (45x90 cm)	5623
	peldaño grad. áng. (90x90 cm)	5829

+ INFO pag. 207.



Kankare Ivory Natural 89,46x89,46 cm

PLAIN TILES. BASE. BASES



Kankare vison natural

89,46 x 89,46 cm - 35.22" x 35.22"

G-6372



Kankare vison natural

44,63 x 89,46 cm - 17.57" x 35.22"

G-6224



Kankare vison cenefa 3 natural

14,70 x 89,46 cm - 5.90" x 35.22"

G-6330

SPECIAL PIECES. PEZZI SPECIALI. PIEZAS ESPECIALES



Kankare vison lines natural

44,63 x 89,46 cm - 17.57" x 35.22"

G-6250



Kankare vison rubic natural

44,63 x 89,46 cm - 17.57" x 35.22"

G-6250



Kankare vison natural rodapié 90

7,3 x 89,46 cm - 2.87" x 35.22"

G-5125



Kankare vison natural rodapié 45

7,3 x 44,63 cm - 2.87" x 17.57"

G-5085

natural

CLASE 1

UNE - ENV 12633

R9

DIN 51130

DCOF>0.42

ANSI A 137.1 - 2012

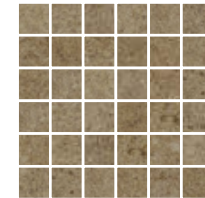

Kankare vison natural mosaico 3,5x3,5

29,75 x 29,75 cm - 11.71" x 11.71"

G-6644

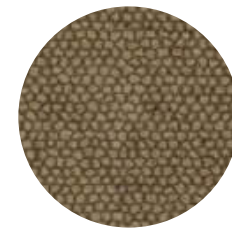

* DETAIL. Kankare vison rubic natural
* DETALLE. Kankare vison rubic natural

STEPS. GRADINI. PELDAÑOS

SIMPLE

GRADONE

		natural
peldaño simple-45	(45x90 cm)	5305
peldaño simple-90	(90x90 cm)	5585
peldaño simple áng.	(45x90 cm)	5315
peldaño simple áng.	(90x90 cm)	5609
peldaño grad-45	(45x90 cm)	5603
peldaño grad-90	(90x90 cm)	5779
peldaño grad. áng.	(45x90 cm)	5623
peldaño grad. áng.	(90x90 cm)	5829

+ INFO pag. 207.



KANKARE

Kankare Vison Natural 89,46x89,46 cm

PLAIN TILES. BASE. BASES



Kankare grey natural

89,46 x 89,46 cm - 35.22" x 35.22"

G-6372



Kankare grey natural

44,63 x 89,46 cm - 17.57" x 35.22"

G-6224

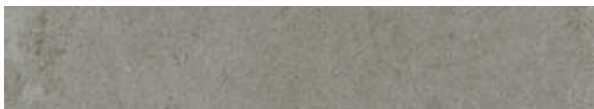

Kankare grey cenefa 3 natural

14,70 x 89,46 cm - 5.90" x 35.22"

G-6330

SPECIAL PIECES. PEZZI SPECIALI. PIEZAS ESPECIALES

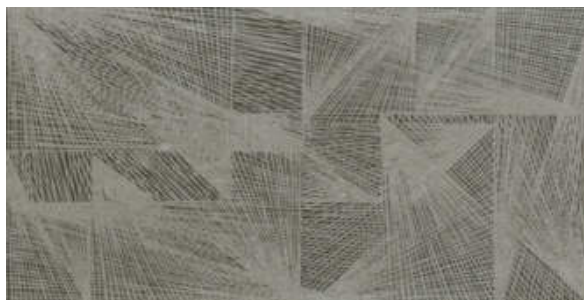

Kankare grey lines natural

44,63 x 89,46 cm - 17.57" x 35.22"

G-6250



Kankare grey rubic natural

44,63 x 89,46 cm - 17.57" x 35.22"

G-6250



Kankare grey natural rodapié 90

7,3 x 89,46 cm - 2.87" x 35.22"

G-5125



Kankare grey natural rodapié 45

7,3 x 44,63 cm - 2.87" x 17.57"

G-5085

natural

CLASE 1

UNE - ENV 12633

R9

DIN 51130

DCOF>0.42

ANSI A 137.1 - 2012

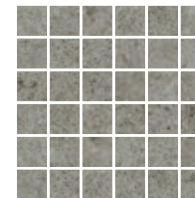

Kankare grey natural mosaico 3,5x3,5

29,75 x 29,75 cm - 11.71" x 11.71"

G-6644

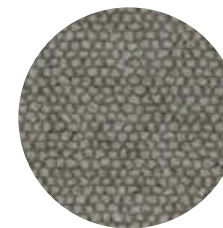

* DETAIL. Kankare grey rubic natural
* DETALLE. Kankare grey rubic natural

STEPS. GRADINI. PELDAÑOS

SIMPLE

GRADONE

		natural
peldaño simple-45	(45x90 cm)	5305
peldaño simple-90	(90x90 cm)	5585
peldaño simple áng.	(45x90 cm)	5315
peldaño simple áng.	(90x90 cm)	5609
peldaño grad-45	(45x90 cm)	5603
peldaño grad-90	(90x90 cm)	5779
peldaño grad. áng.	(45x90 cm)	5623
peldaño grad. áng.	(90x90 cm)	5829

+ INFO pag. 207.



KANKARE

wall: Kankare Ivory Lines 89,46x89,46 cm
floor: Kankare Grey Natural 89,46x89,46 cm

KANKARE

SPECIAL PIECES.
PEZZI SPECIALI. PIEZAS ESPECIALES

natural **CLASE 1** **R9**
UNE - ENV 12633 DIN 51130
DCOF>0.42
ANSI A 137.1 - 2012



Conjunto Kankare ivory & vision natural mosaico 3D*

44,63x44,63 cm - 17.57" x 17.57"

G-6756**



Kankare ivory & vision natural hexagon 3D

18,29x31,56 cm - 7.20" x 12.42"

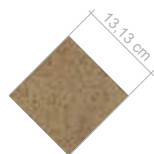

Taco Kankare vision natural mosaico 3D

13,13x13,13 cm - 5.17" x 5.17"

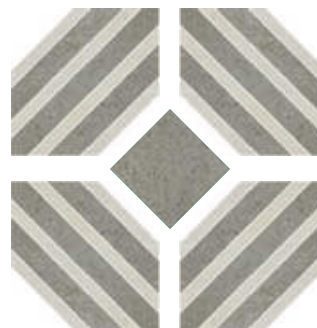

Conjunto Kankare ivory & grey natural mosaico 3D*

44,63x44,63 cm - 17.57" x 17.57"

G-6756**



Kankare ivory & grey natural hexagon 3D

18,29x31,56 cm - 7.20" x 12.42"

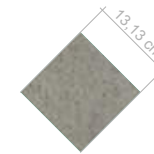

Taco Kankare grey natural mosaico 3D

13,13x13,13 cm - 5.17" x 5.17"



Kankare vision chevron natural

14,70 x 89,46cm - 5.90" x 35.22"

G-6594



Kankare ivory chevron natural

14,70 x 89,46cm - 5.90" x 35.22"

G-6594



Kankare grey chevron natural

14,70 x 89,46cm - 5.90" x 35.22"

G-6594

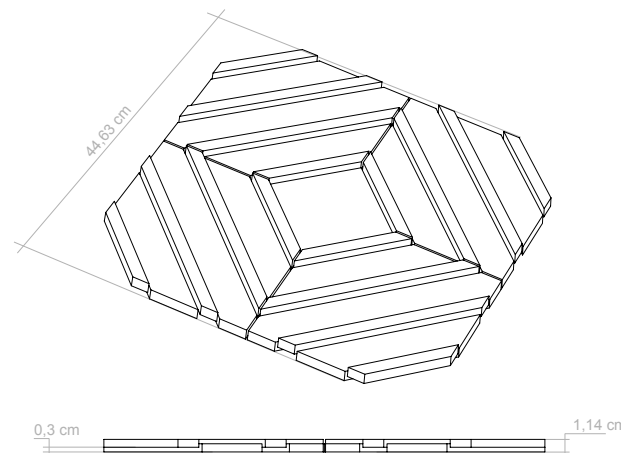

***5 PIECE COMPOSITION.**

4xKankare hexagon 3D + 1xKankare taco. An additional taco for composition (included in the box) is required to complete the tile composition on the wall.

***COMPOSICIÓN DE 5 PIEZAS.**

4xKankare Hexagon Mos. 3D + 1xKankare Taco Mos. 3D. Un taco adicional por composición (incluido en la caja) es necesario para completar la composición del mosaico en pared.

****BOX CONTENT:** 4 sets, including: 16xKankare Hexagon Mos. 3D + 8xKankare Taco Mos. 3D.

****CONTENIDO DE LA CAJA:** 16xKankare Hexagon Mos. 3D + 8xKankare Taco Mos. 3D.

COMPOSITIONS
COMPOSIZIONI. COMPOSICIONES



COMPOSITION. COMPOSICIÓN
Kankare hexagon 3D
Kankare taco.















COMPOSITION. COMPOSICIÓN
Kankare hexagon 3D
Kankare taco.



COMPOSITION. COMPOSICIÓN
Kankare chevron ivory
Kankare chevron grey
Kankare chevron vison
Pieces are sold separately. Las piezas se venden por separado.

For more information, please contact our commercial department.
Para más información, por favor, contacte con nuestro departamento comercial

TECHNICAL CHARACTERISTICS.CARACTERÍSTICAS TÉCNICAS

MEASUREMENTS AND SURFACES APPEARANCE MEDIDAS Y ASPECTO SUPERFICIAL		STANDARD TEST METHOD STANDARD TEST METHOD	STANDARD PRESCRIBED VALUES STANDARDWERTE	KANKARE collection
	Length and width. Lunghezza e larghezza. Longitud y anchura. Länge und Breite	ISO 10545-2	± 0,6% max.	± 0,1%*
	Orthogonality. Ortogonalità. Ortogonalidad. Rechtwinkligkeit	ISO 10545-2	± 0,6% max.	± 0,2%*
	Straightness of sides. Rettilinearità dei lati. Rectitud de lados. Kantengeradigkeit	ISO 10545-2	± 0,5% max.	± 0,2%*
	Surfaces flatness. Planarità. Planitud. Ebenflächigkeit	ISO 10545-2	± 0,5% max.	± 0,2%*
PHYSICAL PROPERTIES / PROPIEDADES FÍSICAS				
	Water absorption. Assorbimento d' acqua. Absorción de agua. Wasseraufnahme	ISO 10545-3	≤ 0,5%	< 0,1%
	Breaking strength, in N. Carico di rottura, in N. Carga de rotura, en N. Bruchlast, in N	ISO 10545-4	≥ 700 N	> 1400 N*
	Modulus of rupture Resistenza alla flessione. Resistencia a la flexión. Biegefestigkeit	ISO 10545-4	≥ 35 N/mm ²	> 40 N/mm ² *
	Resistance to thermal shock. Resistenza agli sbalzi termici. Resistencia al choque térmico. Temperaturwechselbeständigkeit	ISO 10545-9	No surface defects should be visible Non deve presentare difetti visibili No debe presentar defectos superficiales visibles	Resistant. Resistente. Resistente
	Frost resistance. Resistenza al gelo. Resistencia a la helada. Frostbeständigkeit	ISO 10545-12	No surface defects or cracks should be visible Non deve presentare difetti visibili No debe presentar defectos ni grietas superficiales visibles	Frost Resistant Antighiaccio Resistente a la Helada
	Coefficient of friction. Resistenza allo scivolamento. Coeficiente de fricción. Rutschfestigkeit	UNE - ENV 12633	WET TEST / ENSAYO EN HÚMEDO DRY TEST / ENSAYO EN SECO	CLASE I* DCOF - ANSIA 137.1-2012 > 0.42
	Colour resistance to light. Resistenza dei colori alla luce. Resistencia del color a la luz. Lichtbeständigkeit der Farben	DIN 51094	There should be no colour variations Non deve presentare difetti visibili No debe presentar variaciones de color	No alterations in colour and shine Non presenta alterazioni di colori e lucentezza No presenta variaciones de color y brillo
CHEMICAL PROPERTIES / PROPIEDADES QUÍMICAS				
	Chemical resistance. Resistenza agli agenti chimici. Resistencia química. Chemikalienbeständigkeit	ISO 10545-13	Resistance to household cleaning products and swimmingpools salts. Resistencia a productos domésticos y sales para piscinas.	Min. UB
	Resistance to staining. Resistenza alle macchie. Resistencia a las manchas. Fleckenbeständigkeit	ISO 10545-14	≥ 3	5

* The Land values are the average of different production consignments. For further detail information, please check with our commercial network.

Los valores declarados son el promedio obtenido a través de ensayos de diferentes producciones. Para la obtención de una información detallada consultar a la red comercial.

For projects check technical information with our commercial networks. / Para proyectos obtenga información técnica a través de nuestra red comercial.

3Dimensional

SPECIAL PIECES.
PEZZI SPECIALI. PIEZAS ESPECIALES

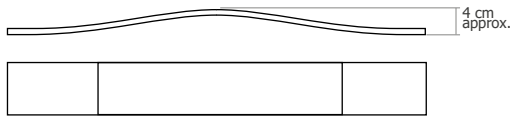

UP
22,21x89,46 cm - 8.74"x35.22"

- Kankare Up 22,21x89,46 cm * **G-5337**

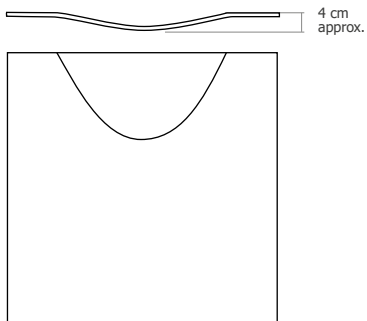

BAG*
89,46 X 89,46 cm / 59,55x59,55 cm

- Kankare Bag 89,46x89,46 cm * **G-5795**
- Kankare Bag 44,63 x 89,46 cm * **G-5599**

* Available in all colours from Kankare collection.
Disponible en todos los colores de la colección Kankare.

This is a natural product made through a handmade process, therefore, its possible shade or size variations must be considered as typical features of the material and they will not be admitted in a claim.

Este es un producto natural fabricado artesanalmente, por lo que posibles variaciones de tono o dimension deben considerarse propias del material y no será objeto de reclamación.

• INFO pag. 208

KANKARE

Kankare Vison Natural UP 22,21x89,46 cm

MATTER



STONE



* Matter ivory natural. Content of recycled material. Contenido de material reciclado.

FORMATS.FORMATI.FORMATOS



60X120
59,55x119,3 cm - 23.45"x46.97"



60X60
59,55x59,55 cm - 23.45"x23.45"



30X120
29,67x119,3 cm - 11.68"x46.97"



30X60
29,75x59,55 cm - 11.71"x23.45"

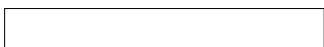

15X120
14,73x119,3 cm - 5.80"x46.97"

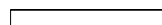

7,5X60
7,3x59,55 cm - 2.87"x23.45"

SPECIAL PIECES.PEZZI SPECIALI.PIEZAS ESPECIALES

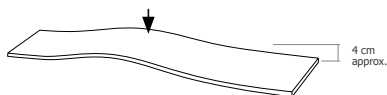

15X120 UP
14,73x118,80 cm - 5.80"x46.77"

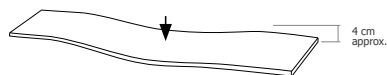

15X120 DOWN
14,73x118,80 cm - 5.80"x46.77"

+ INFO pag. 208.



30X30 mosaico 3,5x3,5
29,75x29,75 cm - 11.71"x11.71"



30X30 mosaico 3D 3,5x10
29,75x29,75 cm - 11.71"x11.71"



7,5X60 rodapié
7,3x59,55 cm - 2.87"x23.45"

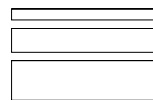

**15X60 - 10X60 - 5X60
multiformat natural***
14,75x59,55 cm - 5.87"x23.45"
9,72x59,55 cm - 3.83"x 23.45"
4,84x59,55 cm - 1.90"x23.45"

*The box contains 5 pieces from each of the formats.
cada caja contiene 5 piezas de cada formato.

THICKNESS.SPESSORE.ESPESORES

≡ 1,18 cm / 0.46" approx. 60x120 cm / 30x120 cm / 15x120 cm FORMATS
≡ 1,03 cm / 0.40" approx. 30x60 cm / 60x60 cm FORMATS

COLOURS COLORI COLORES

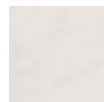

Ivory

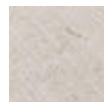

Grey

FINISHES FINITURI ACABADOS



Natural



Lappato

MATTER ivory

PLAIN TILES.BASE.BASES

SPECIAL PIECES.
PEZZI SPECIALI.
PIEZAS ESPECIALES

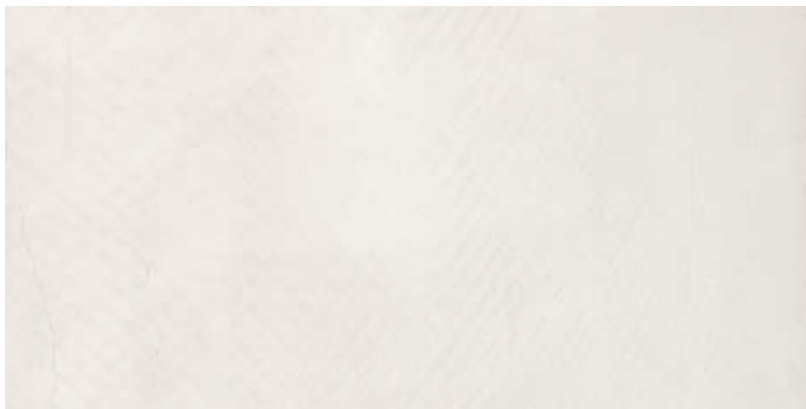

Matter ivory natural
59,55 x 119,3 cm - 23.45" x 46.97"
G-6506

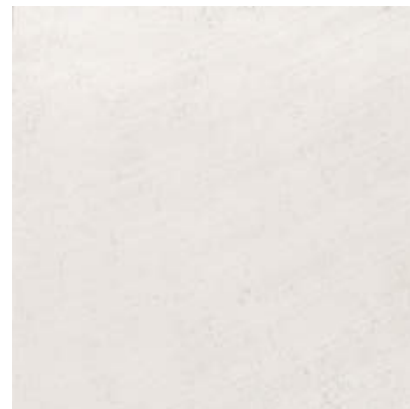

Matter ivory natural / lappato
59,55 x 59,55 cm - 23.45" x 23.45"
G-6286 / G-6330

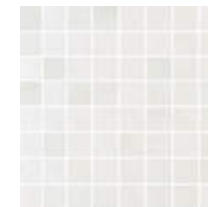

Matter ivory natural
mosaico 3,5x3,5
29,75 x 29,75 cm - 11.71" x 11.71"
G-6756



Matter ivory natural
29,67 x 119,3 cm - 11.68" x 46.97"
G-6544



Matter ivory natural
29,75 x 59,55 cm - 11.71" x 23.45"
G-6218

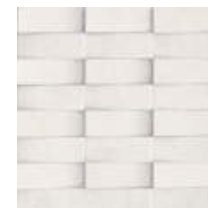

Matter ivory natural
mosaico 3D 3,5x10
29,75 x 29,75 cm - 11.71" x 11.71"
G-5187



Matter ivory natural
14,73 x 119,3 cm - 5.80" x 46.97"
G-6584

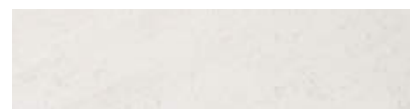

Matter ivory natural multiformat 15x60-10x60-5x60*
14,75x59,55 cm - 5.87"x23.45"
9,72x59,55 cm - 3.83"x 23.45"
4,84x59,55 cm - 1.90"x23.45"
G-6298

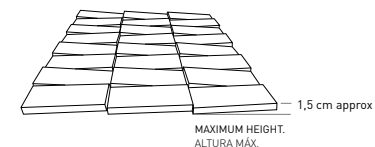

*The box contains 5 pieces from each of the formats.
cada caja contiene 5 piezas de cada formato.

STEPS.GRADINI.PELDAÑOS

		natural		lappato	
SIMPLE		peldaño simple-30 (30x60 cm)	5171	-	-
		peldaño simple-60 (30x60 cm)	5171	-	-
		peldaño simple áng. (30x60 cm)	5187	-	-
		peldaño simple-60 (60x60 cm)	5281	5281	-
		peldaño simple áng. (60x60 cm)	5299	5299	-
		peldaño simple 120 (30x120 cm)	5519	-	-

		natural		lappato	
GRADONE		peldaño grad-30 (30x60 cm)	5559	-	-
		peldaño grad-60 (30x60 cm)	5559	-	-
		peldaño grad. áng (30x60 cm)	5609	-	-
		peldaño grad-60 (60x60 cm)	5559	5559	-
		peldaño grad. áng (60x60 cm)	5609	5609	-
		peldaño grad-120 (30x120 cm)	5795	-	-
		peldaño grad áng (30x120 cm)	5815	-	-

		natural	
STEP		step 120 (30x120 cm)	5795
		step 60 (30x60 cm)	5559

+ INFO pag. 207.

Matter lappato **CLASE 2** **R10**
UNE - ENV 12633 DIN 51130

Matter natural **CLASE 1**
UNE - ENV 12633
DCOF>0.42
ANSI A 137.1 - 2012

Matter ivory natural / lappato listelo
7,3 x 59,55 cm - 2.87" x 23.45"
G-5087 / G-5091

Matter ivory natural rodapié 60
7,3 x 59,55 cm - 2.87" x 23.45"
G-5097



MATTER

Matter Ivory Natural 59,55x59,55 cm

MATTER grey

PLAIN TILES.BASE.BASES



Matter grey natural
59,55 x 119,3 cm - 23.45" x 46.97"
G-6506



Matter grey natural
29,67 x 119,3 cm - 11.68" x 46.97"
G-6544



Matter grey natural
14,73 x 119,3 cm - 5.80" x 46.97"
G-6584

Matter lappato **CLASE 2** **R10**
UNE - ENV 12633 DIN 51130

Matter natural **CLASE 1**
UNE - ENV 12633
DCOF>0.42
ANSI A 137.1 - 2012

STEPS.GRADINI.PELDAÑOS

		natural		lappato		
SIMPLE		peldaño simple-30 (30x60 cm)	5171	-	-	
		peldaño simple-60 (30x60 cm)	5171	-	-	
		peldaño simple áng. (30x60 cm)	5187	-	-	
		peldaño simple-60 (60x60 cm)	5281	5281	-	-
		peldaño simple áng. (60x60 cm)	5299	5299	-	-
		peldaño simple 120 (30x120 cm)	5519	-	-	

		natural		lappato		
GRADONE		peldaño grad-30 (30x60 cm)	5559	-	-	
		peldaño grad-60 (30x60 cm)	5559	-	-	
		peldaño grad. áng (30x60 cm)	5609	-	-	
		peldaño grad-60 (60x60 cm)	5559	5559	-	-
		peldaño grad. áng (60x60 cm)	5609	5609	-	-
		peldaño grad-120 (30x120 cm)	5795	-	-	
		peldaño grad áng (30x120 cm)	5815	-	-	

		natural	
STEP		step 120 (30x120 cm)	5795
		step 60 (30x60 cm)	5559

+ INFO pag. 207.



Matter grey natural / lappato
59,55 x 59,55 cm - 23.45" x 23.45"
G-6286 / G-6330



Matter grey natural
29,75 x 59,55 cm - 11.71" x 23.45"
G-6218

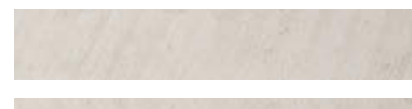

Matter grey natural multiformat 15x60-10x60-5x60*
14,75x59,55 cm - 5.87"x23.45"
9,72x59,55 cm - 3.83"x 23.45"
4,84x59,55 cm - 1.90"x23.45"
G-6298



Matter grey natural / lappato listelo
7,3 x 59,55 cm - 2.87" x 23.45"
G-5087 / G-5091

SPECIAL PIECES. PEZZI SPECIALI. PIEZAS ESPECIALES

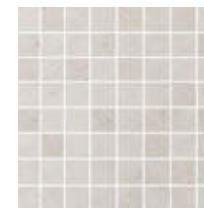

Matter grey natural
mosaico 3,5x3,5
29,75 x 29,75 cm - 11.71" x 11.71"
G-6756



Matter grey natural
mosaico 3D 3,5x10
29,75 x 29,75 cm - 11.71" x 11.71"
G-5187

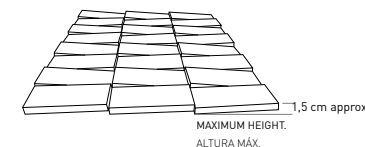

*The box contains 5 pieces from each of the formats.
cada caja contiene 5 piezas de cada formato.

















Matter grey natural rodapié 60
7,3 x 59,55 cm - 2.87" x 23.45"
G-5097



MATTER

Matter Grey Natural 59,55x119,3 cm

TECHNICAL CHARACTERISTICS. CARATTERISTICHE TECNICHE. CARACTERÍSTICAS TÉCNICAS

MEASUREMENTS AND SURFACES APPEARANCE / DIMENSIONI E ASPETTO SUPERFICIALE / MEDIDAS Y ASPECTO SUPERFICIAL / MASSEN UND AUSSEHEN DER OBERFLÄCHE		STANDARD TEST METHOD METODO DELLA NORMA METODO DE ENSAYO STANDARD TEST METHOD	STANDARD PRESCRIBED VALUES VALORE PRESCRITTO VALORES STANDARD NORMA STANDARDWERTE	MATTER collection *
 Length and width. <i>Lunghezza e larghezza.</i> Longitud y anchura. Länge und Breite		ISO 10545-2	± 0,6% max.	± 0,1% *
 Thickness. <i>Spessore.</i> Grosor. Stärke		ISO 10545-2	± 5% max.	± 2% *
 90° Orthogonality. <i>Ortogonalità.</i> Ortogonalidad. Rechtwinkligkeit		ISO 10545-2	± 0,6% max.	± 0,2%
 Straightness of sides. <i>Rettilinearità dei lati.</i> Rectitud de lados. Kantengeradigkeit		ISO 10545-2	± 0,5% max.	± 0,2%
 Surfaces flatness. <i>Planarità.</i> Planitud. Ebenföchigkeit		ISO 10545-2	± 0,5% max.	± 0,2%
PHYSICAL PROPERTIES / PROPIETÀ FISICHE / PROPIEDADES FÍSICAS / PHYSIKALISCHE EIGENSCHAFTEN				
 Water absorption. <i>Assorbimento d'acqua.</i> Absorción de agua. Wasseraufnahme		ISO 10545-3	≤ 0,5%	≤ 0,1%
 Breaking strength, in N. <i>Carico di rottura, en N.</i> Carga de rotura, en N. Bruchlast, in N	thickness>7,5 mm spessore>7,5 mm grosor>7,5 mm	ISO 10545-4	≥ 1300 N	2400 N *
 Modulus of rupture. <i>Resistenza alla flessione.</i> Resistencia a la flexión. Biegefestigkeit		ISO 10545-4	≥ 35 N/mm ²	56 N/mm ² *
 Resistance to deep abrasion. <i>Resistenza all'abrasione profonda.</i> Resistencia a la abrasion profunda. Tiefverschleissbeständigkeit		ISO 10545-6	≤ 175 mm ³	115 mm ³ *
 Resistance to thermal shock. <i>Resistenza agli sbalzi termici.</i> Resistencia al choque térmico. Temperaturwechselbeständigkeit		ISO 10545-9	No surface defects should be visible Non deve presentare difetti visibili No debe presentar defectos superficiales visibles	Resistant. Resistente. Resistente
 Frost resistance. <i>Resistenza al gelo.</i> Resistencia a la helada. Frostbeständigkeit		ISO 10545-12	No surface defects or cracks should be visible Non deve presentare difetti visibili No debe presentar defectos ni grietas superficiales visibles	Frost resistant Antighiaccio Resistente a la Helada
 Coefficient of friction. <i>Resistenza allo scivolamento.</i> Coeficiente de fricción. Rutschfestigkeit		DIN 51130 UNE - ENV 12633	WET TEST/ENSAYO EN HÚMEDO DRY TEST/ENSAYO EN SECO	R9** Clase 1** - Clase 2*** Clase 3**** DCOF - ANSIA 137.1-2012 > 0.42
 Colour resistance to light. <i>Resistenza dei colori alla luce.</i> Resistencia del color a la luz. Lichtbeständigkeit der Farben		DIN 51094	There should be no colour variations Non deve presentare difetti visibili No debe presentar variaciones de color	No alterations in colour and shine Non presenta alterazioni di colori e lucentezza No presenta variaciones de color y brillo
CHEMICAL PROPERTIES / PROPIETÀ CHIMICHE / PROPIEDADES QUÍMICAS / CHEMISCHEN EIGENSCHAFTEN				
 Chemical resistance. <i>Resistenza agli agenti chimici.</i> Resistencia química. Chemikalienbeständigkeit		ISO 10545-13	Resistance to household cleaning products and swimmingpools salts. Resistencia a productos domésticos y sales para piscinas	Min. UB
 Resistance to staining. <i>Resistenza alle macchie.</i> Resistencia a las manchas. Fleckenbeständigkeit		ISO 10545-14	≥ 3	5 *

*The Land values are the average of different production consignments. For further detail information, please check with our commercial network. / I valori dichiarati sono ottenuti da una media di prove effettuate su diverse produzioni. Per avere informazioni dettagliate consultare la rete commerciale. / Los valores declarados son el promedio obtenido a través de ensayos de diferentes producciones. Para la obtención de una información detallada consultar a la red comercial.

** R9 Test carried out on Matter Grey Natural 60x60 (Batch 17-10-12). Ensayo realizado sobre el producto Matter Grey Natural 60x60 (Lote 17-10-12)

** Clase 1 - Tested in natural finish (It depends on the consignment). Test realized in internal laboratory / Provare realizzato in laboratorio interno / Ensayo realizado en laboratorio interno.

*** Clase 2 - Tested in lappato finish (It depends on the consignment) Test realized in internal laboratory / Provare realizzato in laboratorio interno / Ensayo realizado en laboratorio interno.

**** Dry Test, according to document DA DB-SUA/3 (Código Técnico de la Edificación) M° de Fomento. Average test result value, on May 2012. Ensayo realizado, según documento DA DB-SUA/3 (Código Técnico de la Edificación) M° de Fomento. Valor medio a fecha Mayo 2012.

3Dimensional

SPECIAL PIECES. PEZZI SPECIALI. PIEZAS ESPECIALES

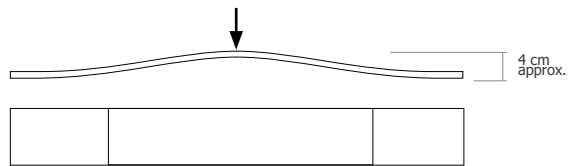

UP
14,73x118,80 cm - 5.80"x46.77"

- Matter Up 14,73x118,80 cm * **G-5435**

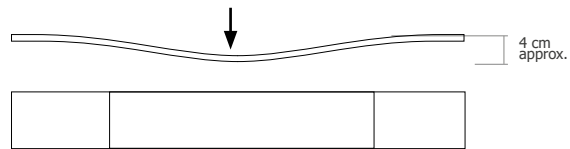

DOWN
14,73x118,80 cm - 5.80"x46.77"

- Matter Down 14,73x118,80 cm * **G-5435**

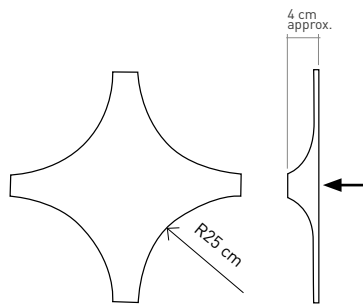

STAR
59,55 x 58,88 cm - 23.45" x 23.18"

- Matter Star 59,55 x 58,88 cm* **G-5435**

* available in all colours from Matter collection.
*disponible en todos los colores de la colección Matter.
+ INFO pag. 208

*This is a natural product made through a handmade process, therefore, its possible shade or size variations must be considered as typical features of the material and they will not be admitted in a claim.

*Este es un producto natural fabricado artesanalmente, por lo que posibles variaciones de tono o dimensión deben considerarse propias del material y no será objeto de reclamación.



MATTER

Matter ivory Star 59,55 x 58,88 cm

MATTER SLIM



STONE



* Matter Slim ivory natural. Content of recycled material. Contenido de material reciclado.

FORMATS.FORMATI.FORMATOS

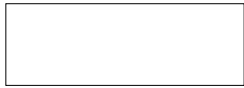

30X90 natural
29,75x89,46 cm - 11.71"x35.22"

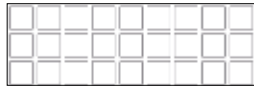

30X90 square
29,75x89,46 cm - 11.71"x35.22"

SPECIAL PIECES.PEZZI SPECIALI.PIEZAS ESPECIALES



30X30 mosaico 2,5x2,5
29,75x29,75 cm - 11.71"x11.71"

THICKNESS.SPESSORE.ESPESORES

 0,48 cm approx. / 0.19" approx.

COLOURS COLORI COLORES



Ivory



Grey

FINISHES FINITURI ACABADOS



Natural

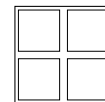

Square

MATTER SLIM ivory

PLAIN TILES.BASE.BASES

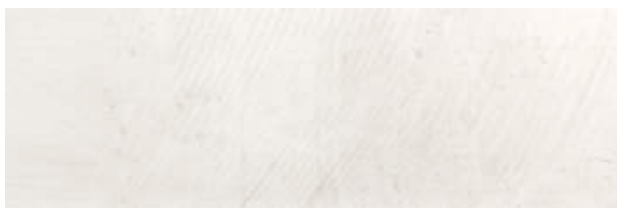

Matter slim ivory natural
29,75 x 89,46 cm - 11.71" x 35.22"
G-6224



Matter slim ivory square
29,75 x 89,46 cm - 11.71" x 35.22"
G-6246

SPECIAL PIECES.PEZZI SPECIALI.PIEZAS ESPECIALES

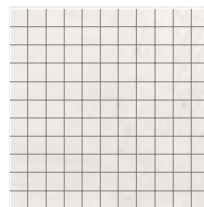

**Matter slim ivory natural
mosaico 2,5x2,5**
29,75 x 29,75 cm - 11.71" x 11.71"
G-6756

COMPLEMENTS.COMPLEMENTI.COMPLEMENTOS



Fusion graffiato lista 90
1,5 x 89,46 cm - 0.59" x 35.22"



G-5091



MATTER SLIM

wall: Matter Slim Ivory Square - Grey Natural 29,75x89,46 cm
floor: Matter Grey Lappato 59,55x59,55 cm

MATTER SLIM grey

PLAIN TILES.BASE.BASES



Matter slim grey natural
29,75 x 89,46 cm - 11.71" x 35.22"
G-6224



Matter slim grey square
29,75 x 89,46 cm - 11.71" x 35.22"
G-6246

SPECIAL PIECES.PEZZI SPECIALI.PIEZAS ESPECIALES

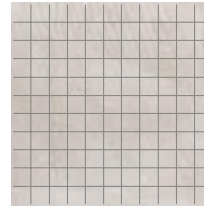

Matter slim grey natural mosaico 2,5x2,5
29,75 x 29,75 cm - 11.71" x 11.71"
G-6756

COMPLEMENTS.COMPLEMENTI.COMPLEMENTOS



Fusion graffiato lista 90
1,5 x 89,46 cm - 0.59" x 35.22"



G-5091



MATTER SLIM

wall: Matter Slim Ivory Natural - Ivory Square - Grey Square 29,75x89,46 cm
floor: Matter Grey Natural 59,55x119,3_29,67x119,3_14,73x119,3 cm

TECHNICAL CHARACTERISTICS. CARATTERISTICHE TECNICHE. CARACTERÍSTICAS TÉCNICAS

MEASUREMENTS AND SURFACES APPEARANCE / DIMENSIONI E ASPETTO SUPERFICIALE / MEDIDAS Y ASPECTO SUPERFICIAL / MASSEN UND AUSSEHEN DER OBERFLÄCHE		STANDARD TEST METHOD METODO DELLA NORMA METODO DE ENSAYO STANDARD TEST METHOD	STANDARD PRESCRIBED VALUES VALORE PRESCRITTO VALORES STANDARD NORMA STANDARDWERTE	Matter Slim *
Length and width. <i>Lunghezza e larghezza.</i> Longitud y anchura. Länge und Breite		ISO 10545-2	± 0,6% max.	± 0,1% *
Orthogonality. <i>Ortogonalità.</i> Ortogonalidad. Rechtwinkligkeit		ISO 10545-2	± 0,6% max.	± 0,2% *
Straightness of sides. <i>Rettilinearità dei lati.</i> Rectitud de lados. Kantengeradigkeit		ISO 10545-2	± 0,5% max.	± 0,2% *
Surfaces flatness. <i>Planarità.</i> Planitud. Ebenföchigkeit		ISO 10545-2	± 0,5% max.	± 0,2% *
PHYSICAL PROPERTIES / PROPIETÀ FISICHE / PROPIEADADES FÍSICAS / PHYSIKALISCHE EIGENSCHAFTEN				
Water absorption. <i>Assorbimento d'acqua.</i> Absorción de agua. Wasseraufnahme		ISO 10545-3	≤ 0,5%	0,1%
Breaking strength, in N. <i>Carico di rottura, en N.</i> Carga de rotura, en N. Bruchlast, in N	thickness <75 mm spessore <7,5 mm grosor <7,5 mm	ISO 10545-4	≥ 700 N	Available Method * Metodo Disponibile Método Disponible
Modulus of rupture. <i>Resistenza alla flessione.</i> Resistencia a la flexión. Biegefestigkeit		ISO 10545-4	≥ 35 N/mm ²	>40 N/mm ² *
Resistance to thermal shock. <i>Resistenza agli sbalzi termici.</i> Resistencia al choque térmico. Temperaturwechselbeständigkeit		ISO 10545-9	No surface defects should be visible <i>Non deve presentare difetti visibili</i> No debe presentar defectos superficiales visibles	Resistant. Resistente. Resistente
Frost resistance. <i>Resistenza al gelo.</i> Resistencia a la helada. Frostbeständigkeit		ISO 10545-12	No surface defects or cracks should be visible <i>Non deve presentare difetti visibili</i> No debe presentar defectos ni grietas superficiales visibles	Frost Resistant Antighiaccio Resistente a la Helada
Coefficient of friction. <i>Resistenza allo scivolamento.</i> Coeficiente de fricción. Rutschfestigkeit		DIN 51130		Available Method Metodo Disponibile Método Disponible
Colour resistance to light. <i>Resistenza dei colori alla luce.</i> Resistencia del color a la luz. Lichtbeständigkeit der Farben		DIN 51094	There should be no colour variations <i>Non deve presentare difetti visibili</i> No debe presentar variaciones de color	No alterations in colour and shine <i>Non presenta alterazioni di colore e lucentezza</i> No presenta variaciones de color y brillo
CHEMICAL PROPERTIES / PROPIETÀ CHIMICHE / PROPIEADADES QUÍMICAS / CHEMISCHEN EIGENSCHAFTEN				
Chemical resistance. <i>Resistenza agli agenti chimici.</i> Resistencia química. Chemikalienbeständigkeit		ISO 10545-13	Resistance to household cleaning products and swimmingpools salts. <i>Resistenza a prodotti d'igiene e sale per piscine</i>	Min.GB
Resistance to staining. <i>Resistenza alle macchie.</i> Resistencia a las manchas. Fleckenbeständigkeit		ISO 10545-14	≥ 3	5 *

*The Land values are the average of different production consignments. For further detail information, please check with our commercial network. /
I valori dichiarati sono ottenuti da una media di prove effettuate su diverse produzioni. Per avere informazioni dettagliate consultare la rete commerciale /
Los valores declarados son el promedio obtenido a través de ensayos de diferentes producciones. Para la obtención de una información detallada consultar a la red comercial.

ADVANTAGES. VANTAGGI. VENTAJAS

- Time. *Tempo.* Tiempo
- Money. *Denaro.* Dinero
- Hygiene. *Igiene.* Higiene
- Ecologic. *Ecologia.* Ecología
- Technology. *Tecnologia.* Tecnología

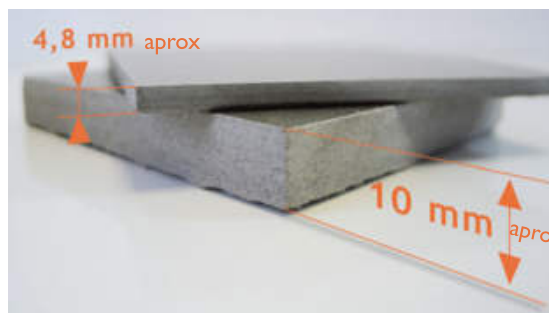

* Recommended only for wall. /
sólo recomendado como revestimiento.



MATTER SLIM

Matter Slim Ivory Natural - Ivory Square 29,75x89,46 cm

PIETRA SERENA



STONE



FJORDPIREN HINNA PARK
Stavanger. (NORWAY)
ARCH: LUND HAGEM

* Pietra Serena ivory natural. Content of recycled material. Contenido de material reciclado.

FORMATS.FORMATI.FORMATOS



45X90
44,63x89,46 cm - 17.57"x35.22"



22,5X90
22,21x89,46 cm - 8.75"x35.22"



60X60
59,55x59,55 cm
23.45"x23.45"



30X60
29,75x59,55 cm
11.71"x23.45"



15X60
14,8x59,55 cm - 5.8"x23.45"



10X60
9,6x59,55 cm - 3.78"x23.45"



7,5X60
7,3x59,55 cm - 2.87"x23.45"

SPECIAL PIECES.PEZZI SPECIALI.PIEZAS ESPECIALES

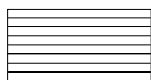

30X60 preincisión 3,5x60
29,75x59,55 cm - 11.71"x23.45"

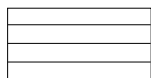

30X60 preincisión 7,5x60
29,75x59,55 cm - 11.71"x23.45"



30X60 preincisión 15x60
29,75x59,55 cm - 11.71"x23.45"



30X60 preincisión irregular
29,75x59,55 cm - 11.71"x23.45"



30X30 mosaico 3,5x3,5
29,75x29,75 cm - 11.71"x11.71"



30X30 mosaico 3,5x3,5
29,75x29,75 cm - 11.71"x11.71"



30X30 decor
29,75x29,75 cm - 11.71"x11.71"



muretto
14,56x29,75 cm
5.73"x11.71"



30X60 you rigato silver/gold
29,75x59,55 cm - 11.71"x23.45"



7,5X60 rodapié
7,3x59,55 cm - 2.87"x23.45"

THICKNESS.SPESSORE.ESPESORES

≡ 1,11 cm / 0.44" approx.

≡ 1,03 cm / 0.40" approx.

45x90 cm / 22,5x90 cm FORMATS

30x60 cm / 60x60 cm FORMATS

COLOURS
COLORI
COLORES

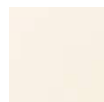

Ivory



Beige



Moss



Graphite

FINISHES
FINITURI
ACABADOS



natural



lappato



filosega



rigato



bocciardato

PIETRA SERENA ivory

PLAIN TILES.BASE.BASES



Pietra Serena ivory natural
44,63 x 89,46 cm - 17.57" x 35.22"
G-6410

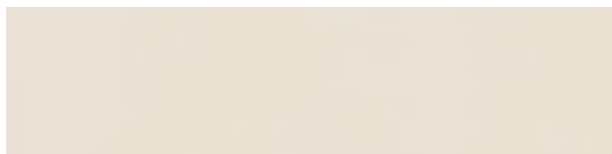

Pietra Serena ivory natural
22,21 x 89,46 cm - 8.75" x 35.22"
G-6456



Pietra Serena ivory rigato
44,63 x 89,46 cm - 17.57" x 35.22"
G-6446

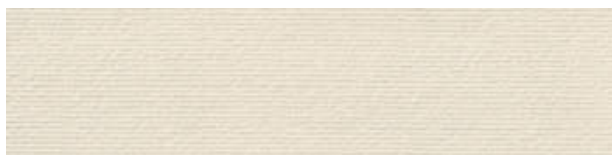

Pietra Serena ivory rigato
22,21 x 89,46 cm - 8.75" x 35.22"
G-6476



Pietra Serena ivory natural / lappato
59,55 x 59,55 cm - 23.45" x 23.45"
G-6410 / 6446

Our product reproduces the natural beauty of the stones, they imitate their veins in order to get realism.

Le nostre pezze simulano la bellezza naturale delle pietre e per questo imitano la sua venatura che gli dà un'apparenza reale.

Nuestro producto reproduce la belleza natural de las piedras, imitando sus vetas para obtener mayor realismo.

Pietra Serena natural

CLASE 1

UNE - ENV 12633

R9

DIN 51130

DCOF>0.42

ANSI A 137.1 - 2012

Pietra Serena filosega

CLASE 3

UNE - ENV 12633

R11

DIN 51130

Pietra Serena rigato

CLASE 3

UNE - ENV 12633

R11

DIN 51130

Pietra Serena bocciardato

CLASE 3

UNE - ENV 12633

R12

DIN 51130

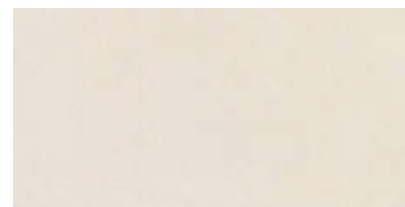

Pietra Serena ivory natural / lappato
29,75 x 59,55 cm - 11.71" x 23.45"
G-6298 / 6330

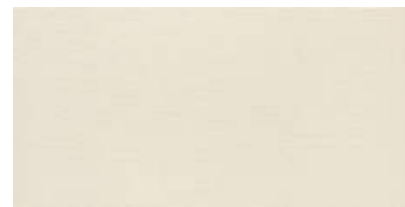

Pietra Serena ivory filosega
29,75 x 59,55 cm - 11.71" x 23.45"
G-6330

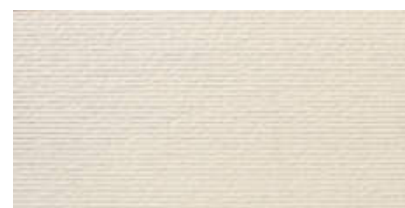

Pietra Serena ivory rigato
29,75 x 59,55 cm - 11.71" x 23.45"
G-6330

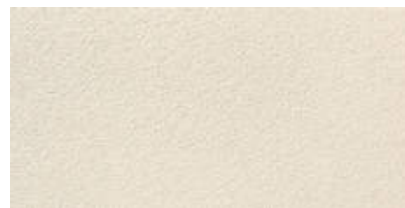

Pietra Serena ivory bocciardato
29,75 x 59,55 cm - 11.71" x 23.45"
G-6330

SPECIAL PIECES. PEZZI SPECIALI. PIEZAS ESPECIALES



Pietra Serena ivory lappato / rigato / bocciardato / filosega preincisión 3,5x60
29,75 x 59,55 cm - 11.71" x 23.45"
G-6486 / 6486 / 6486 / 6486

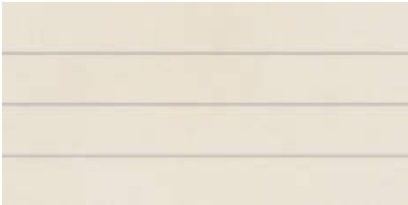

Pietra Serena ivory lappato / rigato / bocciardato / filosega preincisión 7,5x60
29,75 x 59,55 cm - 11.71" x 23.45"
G-6458 / 6458 / 6458 / 6458



Pietra Serena ivory lappato / rigato / bocciardato / filosega preincisión 15x60
29,75 x 59,55 cm - 11.71" x 23.45"
G-6458 / 6458 / 6458 / 6458



Pietra Serena ivory lappato / filosega preincisión irregular
29,75 x 59,55 cm - 11.71" x 23.45"
G-5195 / 5195



Pietra Serena ivory multitex mosaico 3,5x3,5
29,75 x 29,75 cm - 11.71" x 11.71"
G-6768

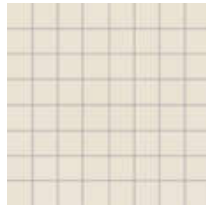

Pietra Serena ivory lappato mosaico 3,5x3,5
29,75 x 29,75 cm - 11.71" x 11.71"
G-6756

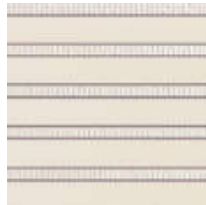

Pietra Serena ivory rigato / bocciardato decor
29,75 x 29,75 cm - 11.71" x 11.71"
G-6708 / 6708



Pietra Serena ivory lappato muretto
14,56 x 29,75 cm - 5.73" x 11.71"
G-5131



Pietra Serena ivory lappato / rigato / bocciardato listelo
7,3 x 59,55 cm - 2.87" x 23.45"
G-5091 / 5091 / 5091



Pietra Serena ivory rigato / bocciardato cenefa-1
9,6 x 59,55 cm - 3.78" x 23.45"
G-5097 / 5097



Pietra Serena ivory rigato / bocciardato cenefa-3
14,8 x 59,55 cm - 5.8" x 23.45"
G-5097 / 5097



Pietra Serena ivory natural rodapié
7,3 x 59,55 cm - 2.87" x 23.45"
G-5097

COMPLEMENTS.COMPLEMENTI.COMPLEMENTOS

Complements complete list on page 205.
Lista completa de complementos en página 205.

STEPS.GRADINI.PELDAÑOS

		natural	lappato	bocciard.	filosega	rigato
SIMPLE	peldaño simple-30 (30x60 cm)	5171	5195	5195	5195	5195
	peldaño simple-60 (30x60 cm)	5171	5195	5195	5195	5195
	peldaño simple áng. (30x60 cm)	5187	5211	5211	5211	5211
	peldaño simple-60 (60x60 cm)	5281	5281	-	-	-
	peldaño simple áng. (60x60 cm)	5299	5299	-	-	-
	peldaño simple (45x90 cm)	5323	-	-	-	-
peldaño simple áng. (45x90 cm)	5333	-	-	-	-	

		natural	lappato	bocciard.	filosega	rigato
GRADONE	peldaño grad-30 (30x60 cm)	5559	5559	5559	5559	5559
	peldaño grad-60 (30x60 cm)	5559	5559	5559	5559	5559
	peldaño grad áng. (30x60 cm)	5609	5609	5609	5609	5609
	peldaño grad. (60x60 cm)	5559	5559	-	-	-
	peldaño grad áng. (60x60 cm)	5609	5609	-	-	-
	peldaño grad-90 (45x90 cm)	5623	-	-	-	-

+ INFO pag. 207.

PIETRA SERENA beige

PLAIN TILES.BASE.BASES

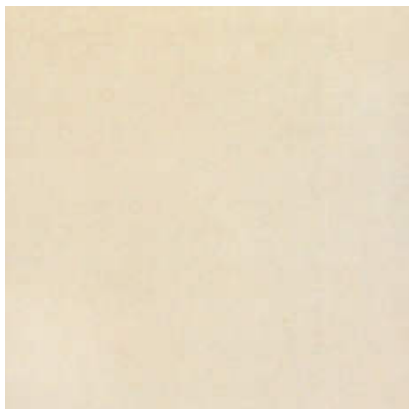

Pietra Serena beige natural
59,55 x 59,55 cm - 23.45" x 23.45"
G-6410 / 6446

Our product reproduces the natural beauty of the stones, they imitate their veins in order to get realism.

Le nostre pezze simulano la bellezza naturale delle pietre e per questo imitano la sua venatura che gli dà un'apparenza reale.

Nuestro producto reproduce la belleza natural de las piedras, imitando sus vetas para obtener mayor realismo.

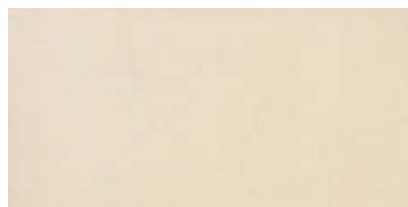

Pietra Serena beige natural / lappato
29,75 x 59,55 cm - 11.71" x 23.45"
G-6298 / 6330



Pietra Serena beige filosega
29,75 x 59,55 cm - 11.71" x 23.45"
G-6330



Pietra Serena beige rigato
29,75 x 59,55 cm - 11.71" x 23.45"
G-6330

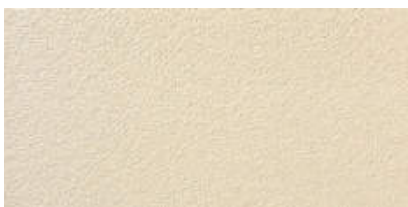

Pietra Serena beige bocciardato
29,75 x 59,55 cm - 11.71" x 23.45"
G-6330

Pietra Serena natural

CLASE 1

R9

UNE - ENV 12633 DIN 51130

DCOF>0.42

ANSI A 137.1 - 2012

Pietra Serena filosega

CLASE 3

R11

UNE - ENV 12633 DIN 51130

Pietra Serena rigato

CLASE 3

R11

UNE - ENV 12633 DIN 51130

Pietra Serena bocciardato

CLASE 3

R12

UNE - ENV 12633 DIN 51130

SPECIAL PIECES.

PEZZI SPECIALI.PIEZAS ESPECIALES

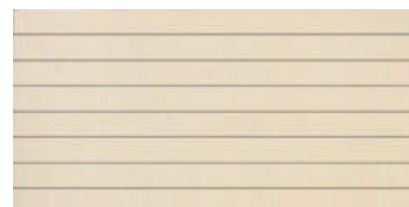

Pietra Serena beige lappato / rigato / bocciardato / filosega preincisión 3,5x60
29,75 x 59,55 cm - 11.71" x 23.45"
G-6486 / 6486 / 6486 / 6486

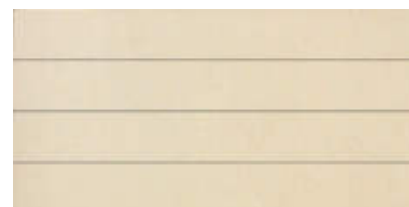

Pietra Serena beige lappato / rigato / bocciardato / filosega preincisión 7,5x60
29,75 x 59,55 cm - 11.71" x 23.45"
G-6458 / 6458 / 6458 / 6458

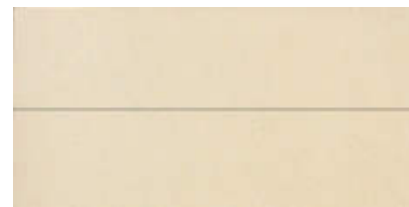

Pietra Serena beige lappato / rigato / bocciardato / filosega preincisión 15x60
29,75 x 59,55 cm - 11.71" x 23.45"
G-6458 / 6458 / 6458 / 6458



Pietra Serena beige lappato / filosega preincisión irregular
29,75 x 59,55 cm - 11.71" x 23.45"
G-5195 / 5195

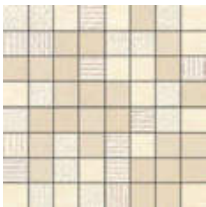

Pietra Serena beige multitex mosaico 3,5x3,5
29,75 x 29,75 cm - 11.71" x 11.71"
G-6768

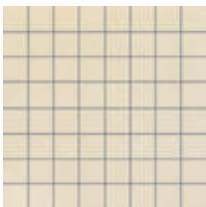

Pietra Serena beige lappato mosaico 3,5x3,5
29,75 x 29,75 cm - 11.71" x 11.71"
G-6754

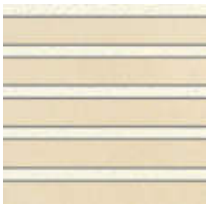

Pietra Serena beige rigato decor / bocciardato decor
29,75 x 29,75 cm - 11.71" x 11.71"
G-6708 / 6708



Pietra Serena beige lappato muretto
14,56 x 29,75 cm - 5.73" x 11.71"
G-5131



Pietra Serena beige lappato / rigato / bocciardato listelo
7,3 x 59,55 cm - 2.87" x 23.45"
G-5091 / 5091 / 5091



Pietra Serena beige rigato / bocciardato cenefa-1
9,6 x 59,55 cm - 3.78" x 23.45"
G-5097 / 5097



Pietra Serena beige rigato / bocciardato cenefa-3
14,8 x 59,55 cm - 5.8" x 23.45"
G-5097 / 5097



Pietra Serena beige natural rodapié
7,3 x 59,55 cm - 2.87" x 23.45"
G-5097

STEPS.GRADINI.PELDAÑOS

		natural	lappato	bocciard	filosega	rigato
SIMPLE	peldaño simple-30 (30x60 cm)	5171	5195	5195	5195	5195
	peldaño simple-60 (30x60 cm)	5171	5195	5195	5195	5195
	peldaño simple áng. (30x60 cm)	5187	5211	5211	5211	5211
	peldaño simple-60 (60x60 cm)	5281	5281	-	-	-
	peldaño simple áng. (60x60 cm)	5299	5299	-	-	-

		natural	lappato	bocciard	filosega	rigato
GRADONE	peldaño grad-30 (30x60 cm)	5559	5559	5559	5559	5559
	peldaño grad-60 (30x60 cm)	5559	5559	5559	5559	5559
	peldaño grad áng. (30x60 cm)	5609	5609	5609	5609	5609
	peldaño grad. (60x60 cm)	5559	5559	-	-	-
	peldaño grad áng. (60x60 cm)	5609	5609	-	-	-

+ INFO pag. 207.

COMPLEMENTS.COMPLEMENTI. COMPLEMENTOS

Complements complete list on page 205.
Lista completa de complementos en página 205.



PIETRA SERENA

ALFONSO I HOTEL****
Zaragoza. (SPAIN)
INT. DESIGN: PASCUA ORTEGA

PIETRA SERENA moss

PLAIN TILES.BASE.BASES



Pietra Serena moss natural / lappato
59,55 x 59,55 cm - 23.45" x 23.45"
G-6372 / 6410



Pietra Serena moss rigato
44,63 x 89,46 cm - 17.57" x 35.22"
G-6410



Pietra Serena moss rigato
29,75 x 59,55 cm - 11.71" x 23.45"
G-6298



Pietra Serena moss natural / lappato
29,75 x 59,55 cm - 11.71" x 23.45"
G-6258 / 6298



Pietra Serena moss rigato
22,21 x 89,46 cm - 8.75" x 35.22"
G-6456



Pietra Serena moss bocciardato
29,75 x 59,55 cm - 11.71" x 23.45"
G-6298

Pietra Serena natural

CLASE 1

R9

UNE - ENV 12633 DIN 51130

DCOF>0.42

ANSI A 137.1 - 2012

Pietra Serena filosega

CLASE 3

R11

UNE - ENV 12633 DIN 51130

Pietra Serena rigato

CLASE 3

R11

UNE - ENV 12633 DIN 51130

Pietra Serena bocciardato

CLASE 3

R12

UNE - ENV 12633 DIN 51130

SPECIAL PIECES. PEZZI SPECIALI. PIEZAS ESPECIALES



Pietra Serena moss lappato / rigato / bocciardato preincisión 3,5x60
29,75 x 59,55 cm - 11.71" x 23.45"
G-6486 / 6486 / 6486 / 6486



Pietra Serena moss lappato / rigato / bocciardato preincisión 7,5x60
29,75 x 59,55 cm - 11.71" x 23.45"
G-6458 / 6458 / 6458 / 6458



Pietra Serena moss lappato / rigato / bocciardato preincisión 15x60
29,75 x 59,55 cm - 11.71" x 23.45"
G-5195 / 6458 / 6458 / 6458



Pietra Serena moss lappato preincisión irregular
29,75 x 59,55 cm - 11.71" x 23.45"
G-5195 / 5195

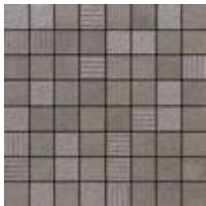

Pietra Serena moss multitex mosaico 3,5x3,5
29,75 x 29,75 cm - 11.71" x 11.71"
G-6768

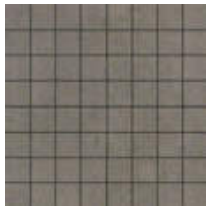

Pietra Serena moss lappato mosaico 3,5x3,5
29,75 x 29,75 cm - 11.71" x 11.71"
G-6756

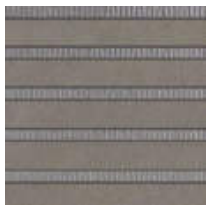

Pietra Serena moss rigato / bocciardato decor / bocciardato decor
29,75 x 29,75 cm - 11.71" x 11.71"
G-6708 / 6708



Pietra Serena moss lappato muretto
14,56 x 29,75 cm - 5.73" x 11.71"
G-5131



Pietra Serena moss lappato / rigato / bocciardato listelo
7,3 x 59,55 cm - 2.87" x 23.45"
G-5091 / 5091 / 5091



Pietra Serena moss rigato / bocciardato cenefa-1
9,60 x 59,55 cm - 3.78" x 23.45"
G-5097 / 5097



Pietra Serena moss rigato / bocciardato cenefa-3
14,8 x 59,55 cm - 5.8" x 23.45"
G-5097 / 5097

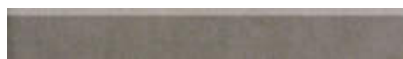

Pietra Serena moss natural rodapié
7,3 x 59,55 cm - 2.87" x 23.45"
G-5097

COMPLEMENTS.COMPLEMENTI.COMPLEMENTOS

Complements complete list on page 205.
Lista completa de complementos en página 205.

STEPS.GRADINI.PELDAÑOS

		natural	lappato	bocciard	filosega	rigato
SIMPLE	peldaño simple-30 (30x60 cm)	5171	5195	5195	5195	5195
	peldaño simple-60 (30x60 cm)	5171	5195	5195	5195	5195
	peldaño simple áng. (30x60 cm)	5187	5211	5211	5211	5211
	peldaño simple-60 (60x60 cm)	5281	5281	-	-	-
	peldaño simple áng. (60x60 cm)	5299	5299	-	-	-
	peldaño simple (45x90 cm)	5323	-	-	-	-
peldaño simple áng. (45x90 cm)	5333	-	-	-	-	

		natural	lappato	bocciard	filosega	rigato
GRADONE	peldaño grad-30 (30x60 cm)	5559	5559	5559	5559	5559
	peldaño grad-60 (30x60 cm)	5559	5559	5559	5559	5559
	peldaño grad áng. (30x60 cm)	5609	5609	5609	5609	5609
	peldaño grad. (60x60 cm)	5559	5559	-	-	-
	peldaño grad áng. (60x60 cm)	5609	5609	-	-	-
	peldaño grad-90 (45x90 cm)	5623	-	-	-	-

+ INFO pag. 207.

PIETRA SERENA **graphite**

PLAIN TILES.BASE.BASES



Pietra Serena graphite natural / lappato
59,55 x 59,55 cm - 23.45" x 23.45"

G-6372 / 6410

Our product reproduces the natural beauty of the stones, they imitate their veins in order to get realism.

Le nostre pezze simulano la bellezza naturale delle pietre e per questo imitano la sua venatura che gli dà un'apparenza reale.

Nuestro producto reproduce la belleza natural de las piedras, imitando sus vetas para obtener mayor realismo.

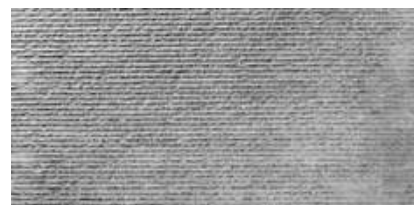

You silver rigato*

29,75 x 59,55 cm - 11.71" x 23.45"

G-5401

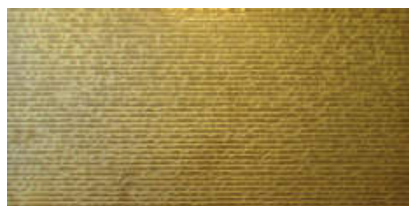

You gold rigato*

29,75 x 59,55 cm - 11.71" x 23.45"

G-5401

* Physical Vapor Deposition [PVD]. Aplicación PVD.
More information on page 221. Más información en página 221.



Pietra Serena graphite natural / lappato

29,75 x 59,55 cm - 11.71" x 23.45"

G-6258 / 6298



Pietra Serena graphite filosega

29,75 x 59,55 cm - 11.71" x 23.45"

G-6298



Pietra Serena graphite bocciardato

29,75 x 59,55 cm - 11.71" x 23.45"

G-6298

Pietra Serena natural

CLASE 1 R9

UNE - ENV 12633 DIN 51130

DCOF>0.42

ANSI A 137.1 - 2012

Pietra Serena filosega

CLASE 3 R11

UNE - ENV 12633 DIN 51130

Pietra Serena rigato

CLASE 3 R11

UNE - ENV 12633 DIN 51130

Pietra Serena bocciardato

CLASE 3 R12

UNE - ENV 12633 DIN 51130

SPECIAL PIECES.

PEZZI SPECIALI.PIEZAS ESPECIALES



Pietra Serena graphite lappato / bocciardato / filosega preincisión 3,5x60

29,75 x 59,55 cm - 11.71" x 23.45"

G-6486 / 6486 / 6486 / 6486



Pietra Serena graphite lappato / bocciardato / filosega preincisión 7,5x60

29,75 x 59,55 cm - 11.71" x 23.45"

G-6458 / 6458 / 6458 / 6458



Pietra Serena graphite lappato / bocciardato / filosega preincisión 15x60

29,75 x 59,55 cm - 11.71" x 23.45"

G-6458 / 6458 / 6458 / 6458



Pietra Serena graphite lappato / filosega preincisión irregular

29,75 x 59,55 cm - 11.71" x 23.45"

G-5195 / 5195

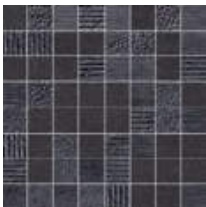

Pietra Serena graphite multitex mosaico 3,5x3,5
29,75 x 29,75 cm - 11.71" x 11.71"
G-6768

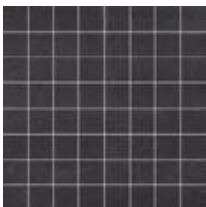

Pietra Serena graphite lappato mosaico 3,5x3,5
29,75 x 29,75 cm - 11.71" x 11.71"
G-6756

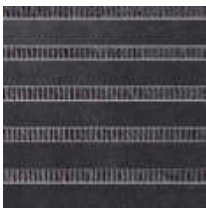

Pietra Serena graphite bocciardato decor
29,75 x 29,75 cm - 11.71" x 11.71"
G-6708 / 6708



Pietra Serena graphite lappato muretto
14,56 x 29,75 cm - 5.73" x 11.71"
G-5131



Pietra Serena graphite lappato / bocciardato listelo
7,3 x 59,55 cm - 2.87" x 23.45"
G-5091 / 5091 / 5091



Pietra Serena graphite bocciardato cenefa-1
9,6 x 59,55 cm - 3.78" x 23.45"
G-5097 / 5097



Pietra Serena graphite bocciardato cenefa-3
14,8 x 59,55 cm - 5.8" x 23.45"
G-5097 / 5097



Pietra Serena graphite natural rodapié
7,3 x 59,55 cm - 2.87" x 23.45"
G-5097

STEPS.GRADINI.PELDAÑOS

		natural	lappato	bocciard	filosega	rigato
SIMPLE	peldaño simple-30 (30x60 cm)	5171	5195	5195	5195	5195
	peldaño simple-60 (30x60 cm)	5171	5195	5195	5195	5195
	peldaño simple áng. (30x60 cm)	5187	5211	5211	5211	5211
	peldaño simple-60 (60x60 cm)	5281	5281	-	-	-
	peldaño simple áng. (60x60 cm)	5299	5299	-	-	-

		natural	lappato	bocciard	filosega	rigato
GRADONE	peldaño grad-30 (30x60 cm)	5559	5559	5559	5559	5559
	peldaño grad-60 (30x60 cm)	5559	5559	5559	5559	5559
	peldaño grad áng. (30x60 cm)	5609	5609	5609	5609	5609
	peldaño grad. (60x60 cm)	5559	5559	-	-	-
	peldaño grad áng. (60x60 cm)	5609	5609	-	-	-

+ INFO pag. 207.

COMPLEMENTS.COMPLEMENTI.COMPLEMENTOS

Complements complete list on page 205.
Lista completa de complementos en página 205.

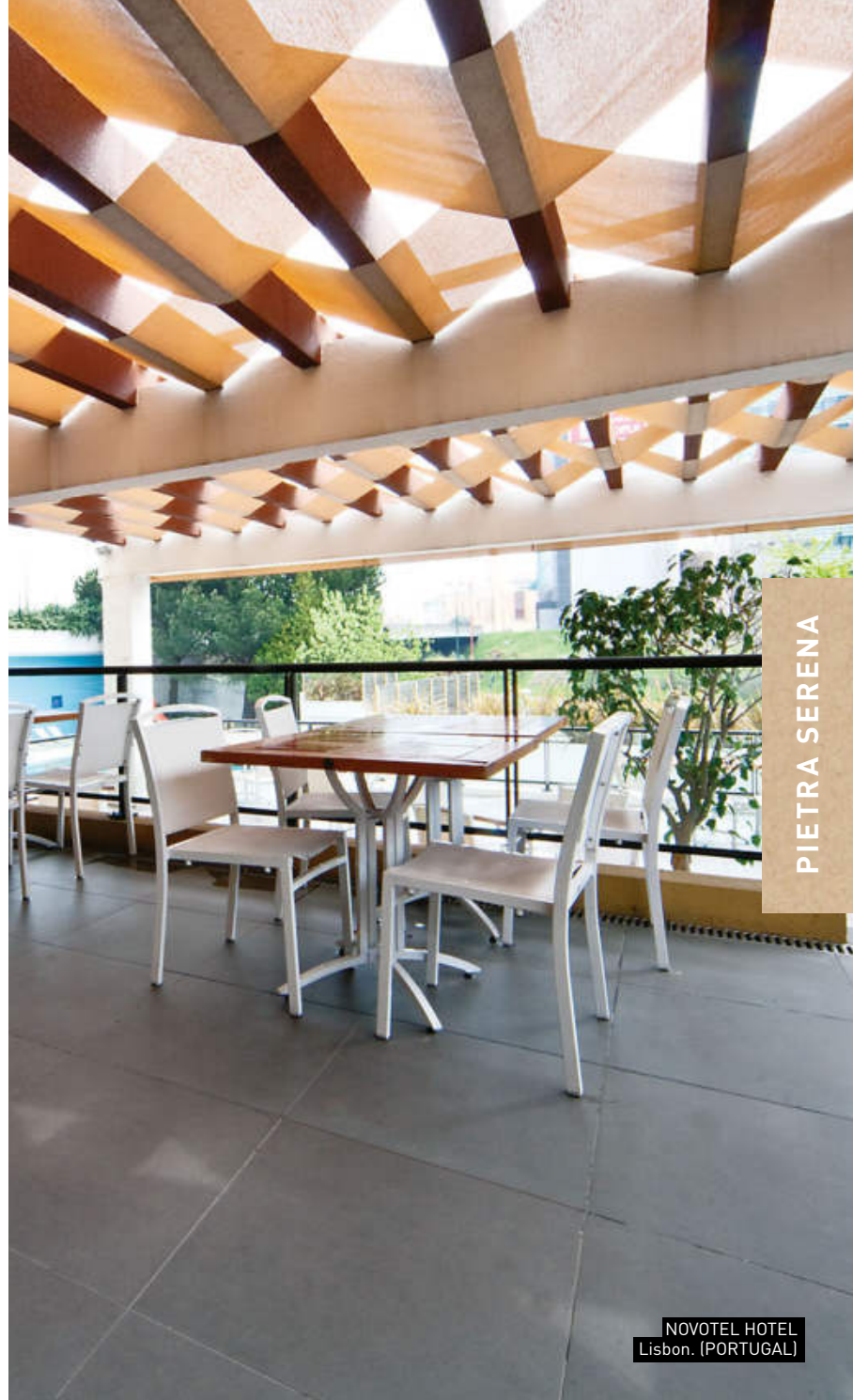

PIETRA SERENA

NOVOTEL HOTEL
Lisbon. (PORTUGAL)



PRIVATE HOUSE
 Portocolom, Mallorca (SPAIN)
 Arch. JOCHEN LENDLE, JLE Arquitectos

Pietra Serena Ivory Natural 29,75x59,55 cm
 Pietra Serena Ivory Rigato 29,75x59,55 cm



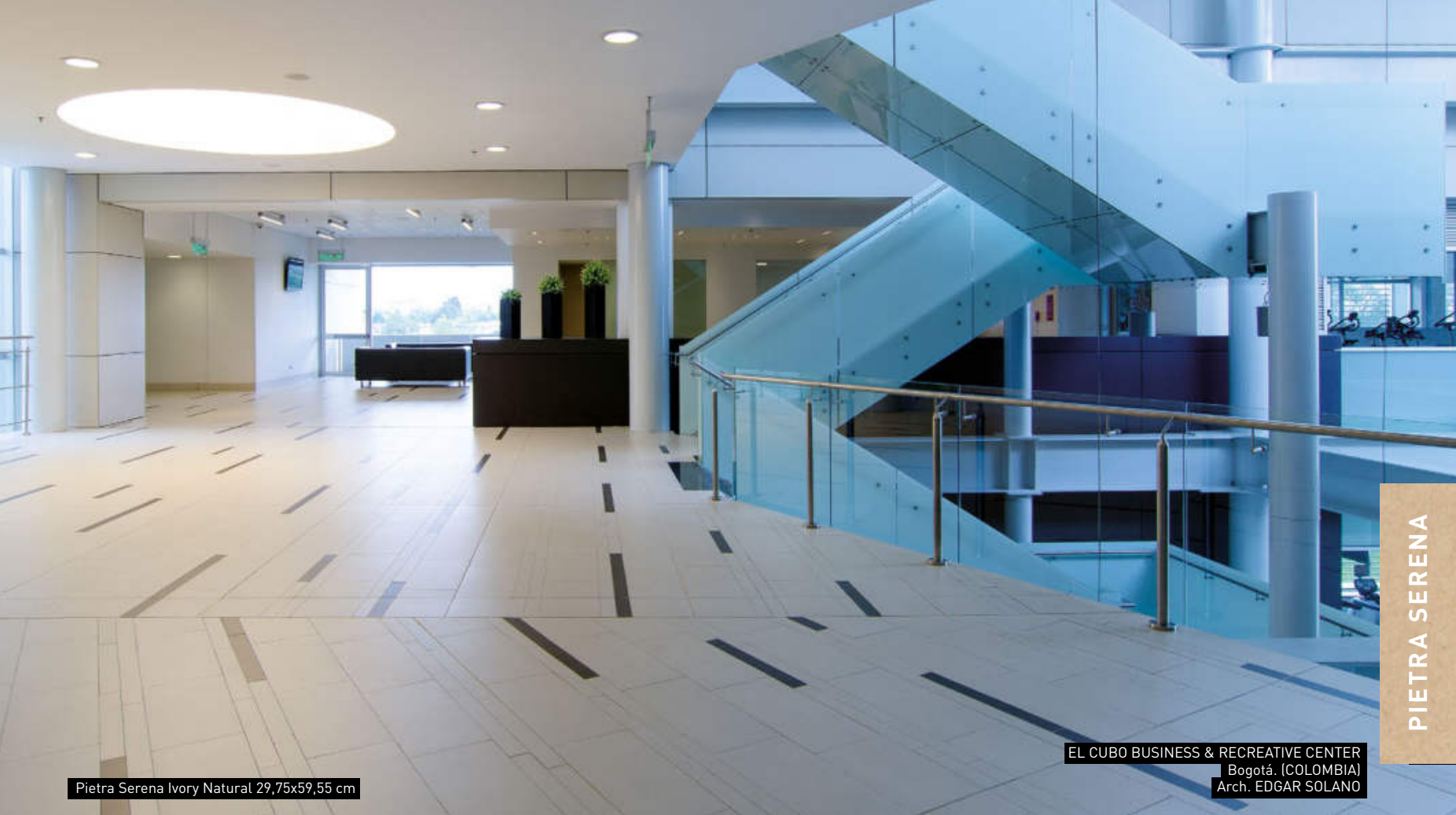

PIETRA SERENA

Pietra Serena Ivory Natural 29,75x59,55 cm







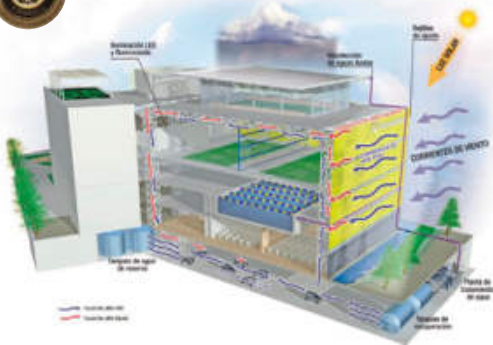







EL CUBO BUSINESS & RECREATIVE CENTER
Bogotá. (COLOMBIA)
Arch. EDGAR SOLANO



1er EDIFICIO con **CERTIFICACIÓN LEED** categoría **ORO** en COLOMBIA.



TECHNICAL CHARACTERISTICS. CARATTERISTICHE TECNICHE. CARACTERÍSTICAS TÉCNICAS

MEASUREMENTS AND SURFACES APPEARANCE / DIMENSIONI E ASPETTO SUPERFICIALE / MEDIDAS Y ASPECTO SUPERFICIAL / MASSEN UND AUSSEHEN DER OBERFLÄCHE		STANDARD TEST METHOD METODO DELLA NORMA METODO DE ENSAYO STANDARD TEST METHOD	STANDARD PRESCRIBED VALUES VALORE PRESCRITTO VALORES STANDARD NORMA STANDARDWERTE	PIETRA SERENA collection *
 Length and width. <i>Lunghezza e larghezza.</i> Longitud y anchura. Länge und Breite		ISO 10545-2	± 0,6% max.	± 0,1% *
 Thickness. <i>Spessore.</i> Grosor. Stärke		ISO 10545-2	± 5% max.	± 2% *
 90° Orthogonality. <i>Ortogonalità.</i> Ortogonalidad. Rechtwinkligkeit		ISO 10545-2	± 0,6% max.	± 0,2%
 Straightness of sides. <i>Rettilinearità dei lati.</i> Rectitud de lados. Kantengeradigkeit		ISO 10545-2	± 0,5% max.	± 0,2%
 Surfaces flatness. <i>Planarità.</i> Planitud. Ebenföchigkeit		ISO 10545-2	± 0,5% max.	± 0,2%
PHYSICAL PROPERTIES / PROPIETÀ FISICHE / PROPIEADADES FÍSICAS / PHYSIKALISCHE EIGENSCHAFTEN				
 Water absorption. <i>Assorbimento d'acqua.</i> Absorción de agua. Wasseraufnahme		ISO 10545-3	≤ 0,5%	≤ 0,1%
 Breaking strength, in N. <i>Carico di rottura, en N.</i> Carga de rotura, en N. Bruchlast, in N	thickness > 7,5 mm spessore > 7,5 mm grösor > 7,5 mm	ISO 10545-4	≥ 1300 N	2800 N *
 Modulus of rupture. <i>Resistenza alla flessione.</i> Resistencia a la flexión. Biegefestigkeit		ISO 10545-4	≥ 35 N/mm ²	52 N/mm ² *
 Resistance to deep abrasion. <i>Resistenza all'abrasione profonda.</i> Resistencia a la abrasión profunda. Tiefverschleissbeständigkeit		ISO 10545-6	≤ 175 mm ³	110 mm ³ *
 Resistance to thermal shock. <i>Resistenza agli sbalzi termici.</i> Resistencia al choque térmico. Temperaturwechselbeständigkeit		ISO 10545-9	No surface defects should be visible Non deve presentare difetti visibili No debe presentar defectos superficiales visibles	Resistant. Resistente. Resistente
 Frost resistance. <i>Resistenza al gelo.</i> Resistencia a la helada. Frostbeständigkeit		ISO 10545-12	No surface defects or cracks should be visible Non deve presentare difetti visibili No debe presentar defectos ni grietas superficiales visibles	Frost Resistant "Antigrassia" Resistente a la Helada
 Coefficient of friction. <i>Resistenza allo scivolamento.</i> Coeficiente de fricción. Rutschfestigkeit		DIN 51130 UNE - ENV 12633 ASTM C 1028-96	WET TEST/ENSAYO EN HÚMEDO DRY TEST/ENSAYO EN SECO S.C.O.F. > 0.60 (for horizontal surfaces)	R9 - R11 - R12** Clase - Clase 3*** Clase 3**** S.C.O.F. 0.70 - 0.70 - 0.77 ***** DCOF - ANSIA 137.1-2012 > 0.42
 Colour resistance to light. <i>Resistenza dei colori alla luce.</i> Resistencia del color a la luz. Lichtbeständigkeit der Farben		DIN 51094	There should be no colour variations Non deve presentare difetti visibili No debe presentar variaciones de color	No alterations in colour and shine Non presenta alterazioni di colori e lucentezza No presenta variaciones de color y brillo
CHEMICAL PROPERTIES / PROPIETÀ CHIMICHE / PROPIEADADES QUÍMICAS / CHEMISCHEN EIGENSCHAFTEN				
 Chemical resistance. <i>Resistenza agli agenti chimici.</i> Resistencia química. Chemikalienbeständigkeit		ISO 10545-13	Resistance to household cleaning products and swimmingpools salts. Resistencia a productos domésticos y sales para piscinas	Min. UB
 Resistance to staining. <i>Resistenza alle macchie.</i> Resistencia a las manchas. Fleckenbeständigkeit		ISO 10545-14	≥ 3	5 *

*The Land values are the average of different production consignments. For further detail information, please check with our commercial network. / I valori dichiarati sono ottenuti da una media di prove effettuate su diverse produzioni. Per avere informazioni dettagliate consultare la rete commerciale / Los valores declarados son el promedio obtenido a través de ensayos de diferentes producciones. Para la obtención de una información detallada consultar a la red comercial.

** R9-Tested in natural finish / R11-Tested in rigato and filosega finishes / R12-Tested in bocciardato finishes

*** Clase 1 - Tested in natural finish (It depends on the consignment) / Clase 3 - Tested in rigato, filosega and bocciardato finishes.
Test realized in internal laboratory / Provaré realizzato in laboratorio interno / Ensayo realizado en laboratorio interno.

**** Dry Test, according to document DA DB-SUA/3 (Código Técnico de la Edificación) M° de Fomento. Average test result value, on May 2012.
Ensayo realizado, según documento DA DB-SUA/3 (Código Técnico de la edificación) M° de Fomento, valor medio a fecha Mayo 2012.

***** SMITH-EMERY laboratories. SCOF: Static Coefficient of Friction. Tested in natural: 0.70 - Tested in lappato: 0.70 - Tested in bocciardato: 0.77

lappato

natural

filosega

rigato

bocciardato

CLASE 1

CLASE 1
R9

CLASE 3
R11

CLASE 3
R11

CLASE 3
R12

PIETRA SERENA

AZULCASCAIS



STONE



ALBORAYA PALMARET - RAILWAY STATION
Valencia. (SPAIN)
Arch. Jose Javier Martí. Rstudio

* Austral ivory natural. Content of recycled material. Contenido de material reciclado.

FORMATS.FORMATI.FORMATOS

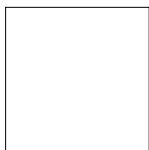

60X60
59,55x59,55 cm
23.45" x23.45"



30X60
29,75x59,55 cm - 11.71"x23.45"

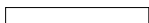

7,5X60
7,3x59,55 cm
2.87" x23.45"

SPECIAL PIECES.PEZZI SPECIALI.PIEZAS ESPECIALES

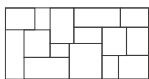

30X60 artech
29,75x59,55 cm - 11.71"x23.45"



30X30 mosaico 3,5x3,5
29,75x29,75 cm - 11.71"x11.71"

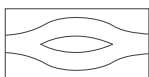

30X60 eye
29,75x59,55 cm - 11.71"x23.45"



30X30 mosaico 3,5x10
29,75x29,75 cm - 11.71"x11.71"



7,5X60 rodapié
7,3x59,55 cm - 2.87"x23.45"



muretto
14,56x29,75 cm
5.73"x11.71"

THICKNESS.SPESSORE.ESPEORES

≡ 1,03 cm / 0.40" approx.

COLOURS COLORI COLORES



Ivory



Moss



Graphite

FINISHES FINITURI ACABADOS



Natural



Lappato



Estructurado

AZULCASCAIS ivory

PLAIN TILES.BASE.BASES



Azulcascais ivory natural
59,55 x 59,55 cm - 23.45" x 23.45"
G-6330



Azulcascais ivory natural / estructurado
29,75 x 59,55 cm - 11.71" x 23.45"
G-6258 / 6298



Azulcascais ivory natural / estructurado listelo
7,3 x 59,55 cm - 2.87" x 23.45"
G-5087 / 5091 / 5091

Azulcascais natural

CLASE 1

UNE - ENV 12633

R10

DIN 51130

Azulcascais estructurado

CLASE 3

UNE - ENV 12633

SPECIAL PIECES.PEZZI SPECIALI.PIEZAS ESPECIALES

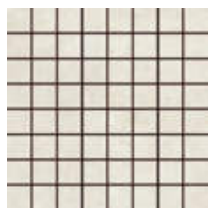

Azulcascais ivory natural mosaico 3,5x3,5
29,75 x 29,75 cm - 11.71" x 11.71"
G-6756

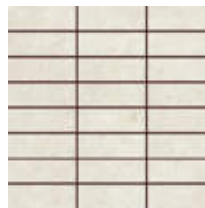

Azulcascais ivory natural mosaico 3,5x10
29,75 x 29,75 cm - 11.71" x 11.71"
G-6748



Azulcascais ivory natural rodapié 60
7,3 x 59,55 cm - 2.87" x 23.45"
G-5097



Azulcascais ivory natural muretto
14,56 x 29,75 cm - 5.73" x 11.71"
G-5131



Azulcascais ivory artech
29,75 x 59,55 cm - 11.71" x 23.45"
G-6298

STEPS.GRADINI.PELDAÑOS

		natural	lappato	estructurado
SIMPLE	peldaño simple-30 (30x60 cm)	5171	-	5195
	peldaño simple-60 (30x60 cm)	5171	-	5195
	peldaño simple áng. (30x60 cm)	5187	-	5211
	peldaño simple (60x60 cm)	5281	5281	-
	peldaño simple áng. (60x60 cm)	5299	5299	-
GRADONE	peldaño grad-30 (30x60 cm)	5559	-	5559
	peldaño grad-60 (30x60 cm)	5559	-	5559
	peldaño grad. áng. (30x60 cm)	5609	-	5609
	peldaño grad-60 (60x60 cm)	5559	5559	-
	peldaño grad. áng. (60x60 cm)	5609	5609	-

+ INFO pag. 207.

COMPLEMENTS.COMPLEMENTI.COMPLEMENTOS

Byte white / moss / red / black lista 60*
1,5 x 59,55 cm - 0.59" x 23.45"
G-5100

Fusion natural lista 60*
1 x 59,55 cm - 0.39" x 23.45"
G-5049

Fusion graffiato lista 60
1,5 x 59,55 cm - 0.59" x 23.45"
G-5069

* recommended only for walls

PLAIN TILES.BASE.BASES



Azulcascais moss natural / lappato
59,55 x 59,55 cm - 23.45" x 23.45"
G-6330 / 6372



Azulcascais moss natural / estructurado
29,75 x 59,55 cm - 11.71" x 23.45"
G-6258 / 6298



Azulcascais moss natural / lappato / estructurado listelo
7,3 x 59,55 cm - 2.87" x 23.45"
G-5087 / 5091 / 5091

Azulcascais natural

CLASE 1
UNE - ENV 12633

R10
DIN 51130

Azulcascais estructurado

CLASE 3
UNE - ENV 12633

SPECIAL PIECES.PEZZI SPECIALI.PIEZAS ESPECIALES

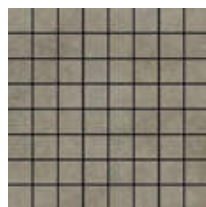

Azulcascais moss natural mosaico 3,5x3,5
29,75 x 29,75 cm - 11.71" x 11.71"
G-6756



Azulcascais moss natural mosaico 3,5x10
29,75 x 29,75 cm - 11.71" x 11.71"
G-6748

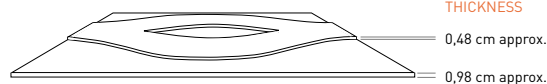

Azulcascais moss eye
29,75 x 59,55 cm - 11.71" x 23.45"
G-5311

STEPS.GRADINI.PELDAÑOS

		natural	lappato	estructurado	
SIMPLE		peldaño simple-30 (30x60 cm)	5171	-	5195
		peldaño simple-60 (30x60 cm)	5171	-	5195
		peldaño simple áng. (30x60 cm)	5187	-	5211
		peldaño simple (60x60 cm)	5281	-	-
GRADONE		peldaño simple áng. (60x60 cm)	5299	5299	-
		peldaño grad-30 (30x60 cm)	5559	-	5559
		peldaño grad-60 (30x60 cm)	5559	-	5559
		peldaño grad. áng. (30x60 cm)	5609	-	5609
		peldaño grad-60 (60x60 cm)	5559	5559	-
		peldaño grad. áng. (60x60 cm)	5609	5609	-

+ INFO pag. 207.



Azulcascais moss natural rodapié 60
7,3 x 59,55 cm - 2.87" x 23.45"
G-5097



Azulcascais moss natural muretto
14,56 x 29,75 cm - 5.73" x 11.71"
G-5131



Azulcascais moss artech *
29,75 x 59,55 cm - 11.71" x 23.45"
G-6298



* Azulcascais moss artech

AZULCASCAIS graphite

PLAIN TILES.BASE.BASES



Azulcascais graphite lappato
59,55 x 59,55 cm - 23.45" x 23.45"
G-6330 / 6372



Azulcascais graphite natural / estructurado
29,75 x 59,55 cm - 11.71" x 23.45"
G-6258 / 6298



Azulcascais graphite natural / lappato / estructurado listelo
7,3 x 59,55 cm - 2.87" x 23.45"
G-5087 / 5091 / 5091

Azulcascais natural

CLASE 1

UNE - ENV 12633

R10

DIN 51130

Azulcascais estructurado

CLASE 3

UNE - ENV 12633

SPECIAL PIECES.PEZZI SPECIALI.PIEZAS ESPECIALES



Azulcascais graphite natural mosaico 3,5x3,5
29,75 x 29,75 cm - 11.71" x 11.71"
G-6756



Azulcascais graphite natural mosaico 3,5x10
29,75 x 29,75 cm - 11.71" x 11.71"
G-6748



THICKNESS

0,48 cm approx.

0,98 cm approx.



Azulcascais graphite eye
29,75 x 59,55 cm - 11.71" x 23.45"
G-5311

STEPS.GRADINI.PELDAÑOS

		natural	lappato	estructurado
SIMPLE	peldaño simple-30 (30x60 cm)	5171	-	5195
	peldaño simple-60 (30x60 cm)	5171	-	5195
	peldaño simple áng. (30x60 cm)	5187	-	5211
	peldaño simple (60x60 cm)	5281	5281	-
	peldaño simple áng. (60x60 cm)	5299	5299	-
GRADONE	peldaño grad-30 (30x60 cm)	5559	-	5559
	peldaño grad-60 (30x60 cm)	5559	-	5559
	peldaño grad. áng. (30x60 cm)	5609	-	5609
	peldaño grad-60 (60x60 cm)	5559	5559	-
	peldaño grad. áng. (60x60 cm)	5609	5609	-

+ INFO pag. 207.



Azulcascais graphite natural rodapié 60
7,3 x 59,55 cm - 2.87" x 23.45"
G-5097



Azulcascais graphite natural muretto
14,56 x 29,75 cm - 5.73" x 11.71"
G-5131

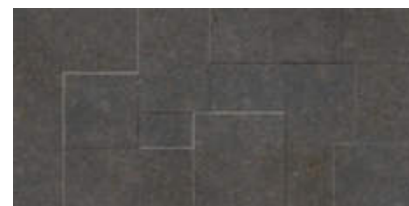

Azulcascais graphite artech
29,75 x 59,55 cm - 11.71" x 23.45"
G-6298

COMPLEMENTS.COMPLEMENTI.COMPLEMENTOS



Byte white / moss / red / black lista 60*
1,5 x 59,55 cm - 0.59" x 23.45"
G-5100

Fusion natural lista 60*
1 x 59,55 cm - 0.39" x 23.45"
G-5049

Fusion graffiato lista 60
1,5 x 59,55 cm - 0.59" x 23.45"
G-5069

* recommended only for walls

















Azulcascais Moss Natural 60x60 cm

ALBORAYA PALMARET RAILWAY STATION
Valencia. (SPAIN)
Arch. Jose Javier MARTÍ. Rstudio

AZULCASCAIS



TECHNICAL CHARACTERISTICS. CARATTERISTICHE TECNICHE. CARACTERÍSTICAS TÉCNICAS

MEASUREMENTS AND SURFACES APPEARANCE / DIMENSIONI E ASPETTO SUPERFICIALE / MEDIDAS Y ASPECTO SUPERFICIAL / MASSEN UND AUSSEHEN DER OBERFLÄCHE		STANDARD TEST METHOD METODO DELLA NORMA METODO DE ENSAYO STANDARD TEST METHOD	STANDARD PRESCRIBED VALUES VALORE PRESCRITTO VALORES STANDARD NORMA STANDARDWERTE	AZULCASCAIS collection *
 Length and width. <i>Lunghezza e larghezza.</i> Longitud y anchura. Länge und Breite		ISO 10545-2	± 0,6% max.	± 0,1%
 Thickness. <i>Spessore.</i> Grosor. Stärke		ISO 10545-2	± 5% max.	± 2%
 90° Orthogonality. <i>Ortogonalità.</i> Ortogonalidad. Rechtwinkligkeit		ISO 10545-2	± 0,6% max.	± 0,2%
 Straightness of sides. <i>Rettilinearità dei lati.</i> Rectitud de lados. Kantengeradigkeit		ISO 10545-2	± 0,5% max.	± 0,2%
 Surfaces flatness. <i>Planarità.</i> Planitud. Ebenföchigkeit		ISO 10545-2	± 0,5% max.	± 0,2%
PHYSICAL PROPERTIES / PROPIETÀ FISICHE / PROPIEDADES FÍSICAS / PHYSIKALISCHE EIGENSCHAFTEN				
 Water absorption. <i>Assorbimento d'acqua.</i> Absorción de agua. Wasseraufnahme		ISO 10545-3	≤ 0,5%	≤ 0,1%
 Breaking strength, in N. <i>Carico di rottura, en N.</i> Carga de rotura, en N. Bruchlast, in N	thickness > 7,5 mm spessore > 7,5 mm grosor > 7,5 mm	ISO 10545-4	≥ 1300 N	2400 N *
 Modulus of rupture. <i>Resistenza alla flessione.</i> Resistencia a la flexión. Biegefestigkeit		ISO 10545-4	≥ 35 N/mm ²	56 N/mm ² *
 Resistance to deep abrasion. <i>Resistenza all'abrasione profonda.</i> Resistencia a la abrasión profunda. Tiefverschleissbeständigkeit		ISO 10545-6	≤ 175 mm ³	115 mm ³ *
 Resistance to thermal shock. <i>Resistenza agli sbalzi termici.</i> Resistencia al choque térmico. Temperaturwechselbeständigkeit		ISO 10545-9	No surface defects should be visible <i>Non deve presentare difetti visibili</i> No debe presentar defectos superficiales visibles	Resistant. <i>Resistente. Resistente</i>
 Resistance to frost. <i>Resistenza al gelo.</i> Resistencia a la helada. Frostbeständigkeit		ISO 10545-12	No surface defects or cracks should be visible <i>Non deve presentare difetti visibili</i> No debe presentar defectos ni grietas superficiales visibles	Frost Resistant <i>Antigranizo</i> Resistente a la Helada
 Coefficient of friction. <i>Resistenza allo scivolamento.</i> Coeficiente de fricción. Rutschfestigkeit		DIN 51130 UNE - ENV 12633	WET TEST/ENSAYO EN HÚMEDO DRY TEST/ENSAYO EN SECO	R10** Clase 1 *** - Clase 3 **** Clase 3 ****
 Colour resistance to light. <i>Resistenza dei colori alla luce.</i> Resistencia del color a la luz. Lichtbeständigkeit der Farben		DIN 51094	There should be no colour variations <i>Non deve presentare difetti visibili</i> No debe presentar variaciones de color	No alterations to colour and shine <i>Non deve presentare alterazioni di colori e lucentezza</i> No debe presentar variaciones de color y brillo
CHEMICAL PROPERTIES / PROPIETÀ CHIMICHE / PROPIEDADES QUÍMICAS / CHEMISCHEN EIGENSCHAFTEN				
 Chemical resistance. <i>Resistenza agli agenti chimici.</i> Resistencia química. Chemikalienbeständigkeit		ISO 10545-13	Resistance to household cleaning products and swimmingpools salts. <i>Resistencia a productos domésticos y sales para piscinas</i>	Min. UB
 Resistance to staining. <i>Resistenza alle macchie.</i> Resistencia a las manchas. Fleckenbeständigkeit		ISO 10545-14	≥ 3	5

*The Land values are the average of different production consignments. For further detail information, please check with our commercial network. /

I valori dichiarati sono ottenuti da una media di prove effettuate su diverse produzioni. Per avere informazioni dettagliate consultare la rete commerciale. /

Los valores declarados son el promedio obtenido a través de ensayos de diferentes producciones. Para la obtención de una información detallada consultar a la red comercial.

** R10 - Tested in Azulcascais Moss Natural (batch: 13-04-2010). It depends on the consignment. /

Provare realizzato in Azulcascais Moss Natural (partita: 13-04-2010). / Ensayo realizado sobre Azulcascais Moss Natural (lote: 13-04-2010).

*** Clase 1 - Tested in natural finish (It depends on the consignment) / Clase 3 - Tested in estructurado finish. Test realized in internal laboratory / Provare realizzato in laboratorio interno / Ensayo realizado en laboratorio interno.

**** Dry Test, according to document DA DB-SUA/3 (Código Técnico de la Edificación) M° de Fomento. Average test result value, on May 2012.

Ensayo realizado, según documento DA DB-SUA/3 (Código Técnico de la edificación) M° de Fomento, valor medio a fecha Mayo 2012.



AZULCASCAIS

Azulcascais Graphite - Ivory Natural 59,55x59,55 cm

CELTIC



STONE

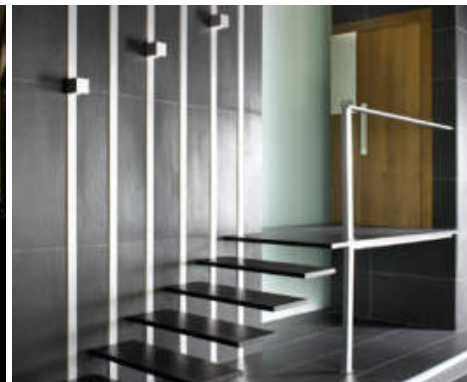

SHOWROOM - OFFICES IMPORT ARRASATE
Mondragón, País Vasco. (SPAIN)

* Celtic black. Content of recycled material. Contenido de material reciclado.

FORMATS.FORMATI.FORMATOS



45X90
44,63x89,46 cm - 17.57"x35.22"



22,5X90
22,21x89,46 cm - 8.75"x35.22"



15X90
14,7x89,46 cm - 5.78"x35.22"



7,5X90
7,3x89,46 cm - 2.87"x35.22"

SPECIAL PIECES.PEZZI SPECIALI.PIEZAS ESPECIALES

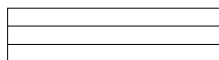

22,5X90 preincisión 7,5x90
22,21x89,46 cm - 8.75"x35.22"



7,5X45 rodapié
7,3x44,63 cm - 2.87"x17.57"



30X30 mosaico 5x5
29,75x29,75 cm - 11.71"x11.71"



30X30 mosaico 5x10
29,75x29,75 cm - 11.71"x11.71"



muretto
14,56x29,75 cm
5.73"x11.71"

THICKNESS.SPESSORE.ESPESORES

 1,11 cm / 0.44" approx.

COLOURS COLORI COLORES

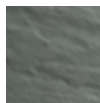

Olive

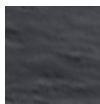

Black

FINISHES FINITURI ACABADOS



Estructurado

PLAIN TILES.BASE.BASES



Celtic olive
44,63 x 89,46 cm - 17.57" x 35.22"
G-6410



Celtic olive
22,21 x 89,46 cm - 8.75" x 35.22"
G-6456



Celtic olive cenefa-3
14,7 x 89,46 cm - 5.78" x 35.22"
G-5155



Celtic olive listelo 90
7,3 x 89,46 cm - 2.87" x 35.22"
G-5119

This collection imitates the natural structure of the slate.
Questa collezione imita la struttura naturale dell'ardesia.
Esta colección imita la estructura natural de la pizarra.

Celtic natural **CLASE 1**
UNE - ENV 12633

SPECIAL PIECES.PEZZI SPECIALI.PIEZAS ESPECIALES

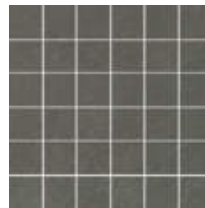

Celtic olive mosaico 5x5
29,75 x 29,75 cm - 11.71" x 11.71"
G-6688

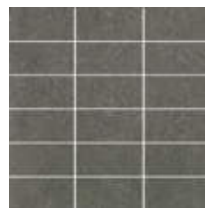

Celtic olive mosaico 5x10
29,75 x 29,75 cm - 11.71" x 11.71"
G-6688



Celtic olive muretto
14,56 x 29,75 cm - 5.73" x 11.71"
G-6768



Celtic olive preincisión 7,5x90
22,21 x 89,46 cm - 8.75" x 35.22"
G-6558



Celtic olive rodapié 45
7,3 x 44,63 cm - 2.87" x 17.57"
G-5087

STEPS.GRADINI.PELDAÑOS

SIMPLE		peldaño-90 (45x90 cm)	5333
		peldaño áng. (45x90 cm)	5345
GRADONE		peldaño grad áng. (45x90 cm)	5645
		peldaño grad-90 (45x90 cm)	5623

* INFO pag. 207

COMPLEMENTS.COMPLEMENTI.COMPLEMENTOS



Byte white / ice / yellow / orange / red / purple / blue / grey / moss / black lista 90*
2 x 89,46 cm - 0.79" x 35.22"
G-5173

Fusion graffiato lista 90
1,5 x 89,46 cm - 0.59" x 35.22"
G-5091

Byte ice / yellow / red / black lista 60*
1,5 x 59,55 cm - 0.59" x 23.45"
G-5100

Fusion natural lista 60*
1 x 59,55 cm - 0.39" x 23.45"
G-5049

Fusion graffiato lista 60
1,5 x 59,55 cm - 0.59" x 23.45"
* recommended only for walls
G-5069



CELTIC

CELTIC black

PLAIN TILES.BASE.BASES



Celtic black

44,63 x 89,46 cm - 17.57" x 35.22"
G-6372



Celtic black

22,21 x 89,46 cm - 8.75" x 35.22"
G-6426



Celtic black cenefa-3

14,7 x 89,46 cm - 5.78" x 35.22"
G-5155



Celtic black listelo 90

7,3 x 89,46 cm - 2.87" x 35.22"
G-5119

This collection imitates the natural structure of the slate.
Questa collezione imita la struttura naturale dell'ardesia.
Esta colección imita la estructura natural de la pizarra.

Celtic natural

CLASE 1

UNE - ENV 12633

SPECIAL PIECES.PEZZI SPECIALI.PIEZAS ESPECIALES

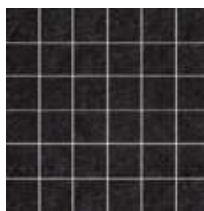

Celtic black mosaico 5x5

29,75 x 29,75 cm - 11.71" x 11.71"
G-6688



Celtic black mosaico 5x10

29,75 x 29,75 cm - 11.71" x 11.71"
G-6688



Celtic black muretto

14,56 x 29,75 cm - 5.73" x 11.71"
G-6768



Celtic black preincisión 7,5x90

22,21 x 89,46 cm - 8.75" x 35.22"
G-6558



Celtic black rodapié 45

7,3 x 44,63 cm - 2.87" x 17.57"
G-5087

STEPS.GRADINI.PELDAÑOS

SIMPLE



peldaño-90	(45x90 cm)	5323
peldaño áng.	(45x90 cm)	5333

GRADONE



peldaño grad áng.	(45x90 cm)	5645
peldaño grad-90	(45x90 cm)	5623

+ INFO pag. 207.

COMPLEMENTS.COMPLEMENTI.COMPLEMENTOS



Byte white / ice / yellow / orange / red / purple / blue / grey / moss / black lista 90*

2 x 89,46 cm - 0.79" x 35.22"



G-5173

Fusion graffiato lista 90

1,5 x 89,46 cm - 0.59" x 35.22"



G-5091

Byte ice / yellow / red / black lista 60*

1,5 x 59,55 cm - 0.59" x 23.45"



G-5100

Fusion natural lista 60*

1 x 59,55 cm - 0.39" x 23.45"



G-5049

Fusion graffiato lista 60

1,5 x 59,55 cm - 0.59" x 23.45"



G-5069

* recommended only for walls

















Celtic Black - 44,63x89,46 cm

CELTIC

BUSINESS & RECREATIVE CENTER EL CUBO
BOGOTÁ. (COLOMBIA)
ARCH: EDGAR SOLANO

TECHNICAL CHARACTERISTICS. CARATTERISTICHE TECNICHE. CARACTERÍSTICAS TÉCNICAS

MEASUREMENTS AND SURFACES APPEARANCE / DIMENSIONI E ASPETTO SUPERFICIALE / MEDIDAS Y ASPECTO SUPERFICIAL / MASSEN UND AUSSEHEN DER OBERFLÄCHE		STANDARD TEST METHOD METODO DELLA NORMA METODO DE ENSAYO STANDARD TEST METHOD	STANDARD PRESCRIBED VALUES VALORE PRESCRITTO VALORES STANDARD NORMA STANDARDWERTE	CELTIC collection *
 Length and width. <i>Lunghezza e larghezza.</i> Longitud y anchura. Länge und Breite		ISO 10545-2	± 0,6% max.	± 0,1%
 Thickness. <i>Spessore.</i> Grosor. Stärke		ISO 10545-2	± 5% max.	± 2%
 90° Orthogonality. <i>Ortogonalità.</i> Ortogonalidad. Rechtwinkligkeit		ISO 10545-2	± 0,6% max.	± 0,2%
 Straightness of sides. <i>Rettilinearità dei lati.</i> Rectitud de lados. Kantengeradigkeit		ISO 10545-2	± 0,5% max.	± 0,2%
 Surfaces flatness. <i>Planarità.</i> Planitud. Ebenföchigkeit		ISO 10545-2	± 0,5% max.	± 0,2%
PHYSICAL PROPERTIES / PROPIETÀ FISICHE / PROPIEADADES FÍSICAS / PHYSIKALISCHE EIGENSCHAFTEN				
 Water absorption. <i>Assorbimento d'acqua.</i> Absorción de agua. Wasseraufnahme		ISO 10545-3	≤ 0,5%	≤ 0,1%
 Breaking strength, in N. <i>Carico di rottura, en N.</i> Carga de rotura, en N. Bruchlast, in N	thickness > 7,5 mm spessore > 7,5 mm grosor > 7,5 mm	ISO 10545-4	≥ 1300 N	2400 N *
 Modulus of rupture. <i>Resistenza alla flessione.</i> Resistencia a la flexión. Biegefestigkeit		ISO 10545-4	≥ 35 N/mm ²	56 N/mm ² *
 Resistance to deep abrasion. <i>Resistenza all'abrasione profonda.</i> Resistencia a la abrasión profunda. Tiefverschleissbeständigkeit		ISO 10545-6	≤ 175 mm ³	106 mm ³ *
 Resistance to thermal shock. <i>Resistenza agli sbalzi termici.</i> Resistencia al choque térmico. Temperaturwechselbeständigkeit		ISO 10545-9	No surface defects should be visible Non deve presentare difetti visibili No debe presentar defectos superficiales visibles	Resistant. Resistente. Resistente
 Frost resistance. <i>Resistenza al gelo.</i> Resistencia a la helada. Frostbeständigkeit		ISO 10545-12	No surface defects or cracks should be visible Non deve presentare difetti visibili No debe presentar defectos ni grietas superficiales visibles	Frost Resistant Antighiaccio Resistencia a la Helada
 Non-slip. <i>Resistenza allo scivolamento.</i> Capacidad antideslizamiento. Rutschfestigkeit		UNE - ENV 12633	WET TEST/ENSAYO EN HÚMEDO DRY TEST/ENSAYO EN SECO	Clase I ** Clase 3 ***
 Colour resistance to light. <i>Resistenza dei colori alla luce.</i> Resistencia del color a la luz. Lichtbeständigkeit der Farben		DIN 51094	There should be no colour variations Non deve presentare difetti visibili No debe presentar variaciones de color	No alterations to colour and shine Non presenta alterazioni di colori e lucentezza No presenta variaciones de color y brillo
CHEMICAL PROPERTIES / PROPIETÀ CHIMICHE / PROPIEADADES QUÍMICAS / CHEMISCHEN EIGENSCHAFTEN				
 Chemical resistance. <i>Resistenza agli agenti chimici.</i> Resistencia química. Chemikalienbeständigkeit		ISO 10545-13	Resistance to household cleaning products and swimmingpools salts. Resistencia a productos domésticos y sales para piscinas	Min. UB
 Resistance to staining. <i>Resistenza alle macchie.</i> Resistencia a las manchas. Fleckenbeständigkeit		ISO 10545-14	≥ 3	5

*The Land values are the average of different production consignments. For further detail information, please check with our commercial network. /
I valori dichiarati sono ottenuti da una media di prove effettuate su diverse produzioni. Per avere informazioni dettagliate consultare la rete commerciale /
Los valores declarados son el promedio obtenido a través de ensayos de diferentes producciones. Para la obtención de una información detallada consultar a la red comercial.

**Test realized in internal laboratory. Provare realizzato in laboratorio interno. Ensayo realizado en laboratorio interno.

***Dry Test, according to document DA DB-SUA/3 (Código Técnico de la Edificación) M° de Fomento. Average test result value, on May 2012.
Ensayo realizado, según documento DA DB-SUA/3 (Código Técnico de la edificación) M° de Fomento, valor medio a fecha Mayo 2012.



Celtic Black - 44,63x89,46 cm

COFFEE MALACCA DEL MAR
Sevilla. (SPAIN)

CELTIC

AUSTRAL



STONE



SHOPPING CENTER EL ZIELO
Madrid. (SPAIN)
Arch. Raquel Fernández Maudez

* Austral copper estructurado. Content of recycled material. Contenido de material reciclado.

FORMATS.FORMATI.FORMATOS



45X90
44,63x89,46 cm - 17.57"x35.22"



30X60
29,75x59,55 cm - 11.71"x23.45"



22,5X90
22,21x89,46 cm - 8.75"x35.22"



7,5X90
7,3x89,46 cm - 2.87"x35.22"



7,5X60
7,3x59,55 cm - 2.87"x23.45"

SPECIAL PIECES.PEZZI SPECIALI.PIEZAS ESPECIALES



22,5X90 preincisión 7,5x90
22,21x89,46 cm - 8.75"x35.22"



30X30 mosaico 3,5x3,5
29,75x29,75 cm - 11.71"x11.71"

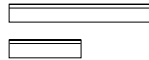

7,5X60 rodapié
7,5X30 rodapié
7,3x59,55 cm - 2.87"x23.45"
7,3x29,75 cm - 2.87"x11.71"



30X60 preincisión 3,5x60
29,75x59,55 cm - 11.71"x23.45"



30X30 mosaico 3,5x15
29,75x29,75 cm - 11.71"x11.71"



muretto
14,56x29,75 cm
5.73"x11.71"

THICKNESS.SPESSORE.ESPESORES

≡ 1,11 cm / 0.44" approx.

≡ 1,03 cm / 0.40" approx.

45x90 cm / 22,5x90 cm FORMATS

30x60 cm FORMAT

COLOURS COLORI COLORES



Ivory



Copper



Antracita

FINISHES FINITURI ACABADOS



Estructurado

PLAIN TILES.BASE.BASES

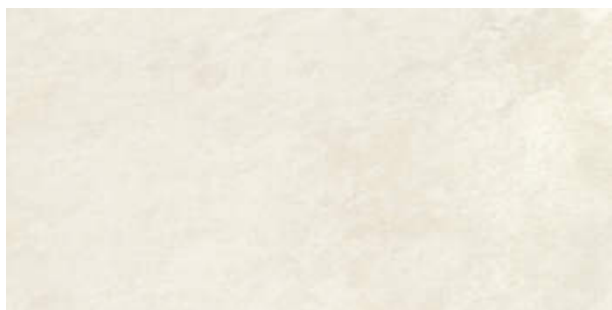

Austral ivory estructurado
44,63 x 89,46 cm - 17.57" x 35.22"
G-6372

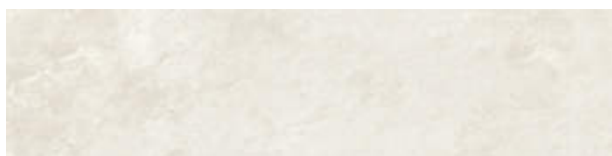

Austral ivory estructurado
22,21 x 89,46 cm - 8.75" x 35.22"
G-6426



Austral ivory estructurado listelo 90
7,3 x 89,46 cm - 2.87" x 35.22"
G-5119



Austral ivory estructurado
29,75 x 59,55 cm - 11.71" x 23.45"
G-6258



Austral ivory estructurado listelo 60
7,3 x 59,55 cm - 2.87" x 23.45"
G-5091

These destonified pieces recreate the appearance of a slate.
I pezzi ricreano con la loro stonizzazione la vera ardesia.
Las piezas recrean con su destonificación y relieve el realismo de la pizarra.

SPECIAL PIECES.PEZZI SPECIALI.PIEZAS ESPECIALES



Austral ivory estructurado mosaico 3,5x3,5
29,75 x 29,75 cm - 11.71" x 11.71"
G-6756



Austral ivory estructurado mosaico 3,5x15
29,75 x 29,75 cm - 11.71" x 11.71"
G-6708



Austral ivory estructurado muretto
14,56 x 29,75 cm - 5.73" x 11.71"
G-6768

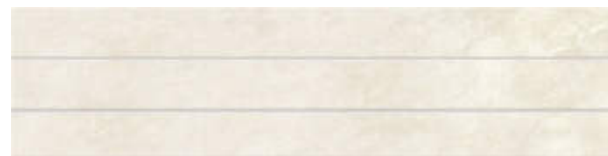

Austral ivory estructurado precisión 7,5x90
22,21 x 89,46 cm - 8.75" x 35.22"
G-6558

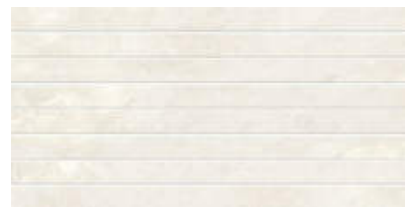

Austral ivory estructurado precisión 3,5x60
29,75 x 59,55 cm - 11.71" x 23.45"
G-6486



Austral ivory estructurado rodapié 30
7,3 x 29,75 cm - 2.87" x 11.71"
G-5075



Austral ivory estructurado rodapié 60
7,3 x 59,55 cm - 2.87" x 23.45"
G-5097

STEPS.GRADINI.PELDAÑOS

SIMPLE	GRADONE																														
<table border="1"> <tr><td>peldaño simple-30</td><td>[30x60 cm]</td><td>5171</td></tr> <tr><td>peldaño simple-60</td><td>[30x60 cm]</td><td>5171</td></tr> <tr><td>peldaño simple áng</td><td>[30x60 cm]</td><td>5187</td></tr> <tr><td>peldaño simple-90</td><td>[45x90 cm]</td><td>5323</td></tr> <tr><td>peldaño simple áng</td><td>[45x90 cm]</td><td>5333</td></tr> </table>	peldaño simple-30	[30x60 cm]	5171	peldaño simple-60	[30x60 cm]	5171	peldaño simple áng	[30x60 cm]	5187	peldaño simple-90	[45x90 cm]	5323	peldaño simple áng	[45x90 cm]	5333	<table border="1"> <tr><td>peldaño grad-30</td><td>[30x60 cm]</td><td>5559</td></tr> <tr><td>peldaño grad-60</td><td>[30x60 cm]</td><td>5559</td></tr> <tr><td>peldaño grad. áng</td><td>[30x60 cm]</td><td>5609</td></tr> <tr><td>peldaño grad-90</td><td>[45x90 cm]</td><td>5623</td></tr> <tr><td>peldaño grad. áng</td><td>[45x90 cm]</td><td>5645</td></tr> </table>	peldaño grad-30	[30x60 cm]	5559	peldaño grad-60	[30x60 cm]	5559	peldaño grad. áng	[30x60 cm]	5609	peldaño grad-90	[45x90 cm]	5623	peldaño grad. áng	[45x90 cm]	5645
peldaño simple-30	[30x60 cm]	5171																													
peldaño simple-60	[30x60 cm]	5171																													
peldaño simple áng	[30x60 cm]	5187																													
peldaño simple-90	[45x90 cm]	5323																													
peldaño simple áng	[45x90 cm]	5333																													
peldaño grad-30	[30x60 cm]	5559																													
peldaño grad-60	[30x60 cm]	5559																													
peldaño grad. áng	[30x60 cm]	5609																													
peldaño grad-90	[45x90 cm]	5623																													
peldaño grad. áng	[45x90 cm]	5645																													

* INFO pag. 207.

Austral natural **CLASE 1**
UNE - ENV 12633



Austral Ivory Estructurado - 29,75x59,55 cm

AUSTRAL

PRIVATE HOUSE. Ventilated Façade
Ourense. (SPAIN)
Int. Design. Interior Designer CSR

AUSTRAL copper

PLAIN TILES.BASE.BASES



Austral copper estructurado
44,63 x 89,46 cm - 17.57" x 35.22"
G-6372



Austral copper estructurado
22,21 x 89,46 cm - 8.75" x 35.22"
G-6426



Austral copper estructurado listelo 90
7,3 x 89,46 cm - 2.87" x 35.22"
G-5119



Austral copper estructurado
29,75 x 59,55 cm - 11.71" x 23.45"
G-6258

SPECIAL PIECES. PEZZI SPECIALI.PIEZAS ESPECIALES

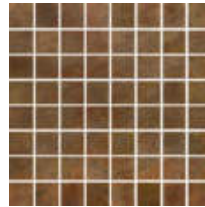

**Austral copper estructurado
mosaico 3,5x3,5**
29,75 x 29,75 cm - 11.71" x 11.71"
G-6756



**Austral copper estructurado
mosaico 3,5x15**
29,75 x 29,75 cm - 11.71" x 11.71"
G-6708



**Austral copper estructurado
muretto**
14,56 x 29,75 cm - 5.73" x 11.71"
G-6768

These destonified pieces recreate the appearance of a slate.
I pezzi ricreano con la loro stonalizzazio-
ne la vera ardesia.
Las piezas recrean con su destonificación
y relieve el realismo de la pizarra.



Austral copper estructurado preincisión 7,5x90
22,21 x 89,46 cm - 8.75" x 35.22"
G-6558



PRIVATE HOUSE
Moaña, Pontevedra. (SPAIN)
Arch. Cristina Cordeiro

Austral Copper Estructurado - 44,63x89,46 cm

PLAIN TILES.BASE.BASES



Austral antracita estructurado
44,63 x 89,46 cm - 17.57" x 35.22"
G-6372



Austral antracita estructurado
22,21 x 89,46 cm - 8.75" x 35.22"
G-6426



Austral antracita estructurado listelo 90
7,3 x 89,46 cm - 2.87" x 35.22"
G-5119



Austral antracita estructurado
29,75 x 59,55 cm - 11.71" x 23.45"
G-6258



Austral antracita estructurado listelo 60
7,3 x 59,55 cm - 2.87" x 23.45"
G-5091

These destonified pieces recreate the appearance of a slate.
I pezzi ricreano con la loro stonizzazione la vera ardesia.
Las piezas recrean con su destonificación y relieve el realismo de la pizarra.

SPECIAL PIECES.PEZZI SPECIALI.PIEZAS ESPECIALES

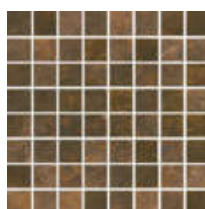

Austral antracita estructurado mosaico 3,5x3,5
29,75 x 29,75 cm - 11.71" x 11.71"
G-6756



Austral antracita estructurado mosaico 3,5x15
29,75 x 29,75 cm - 11.71" x 11.71"
G-6708



Austral antracita estructurado muretto
14,56 x 29,75 cm - 5.73" x 11.71"
G-6768



Austral antracita estructurado preincisión 7,5x90
22,21 x 89,46 cm - 8.75" x 35.22"
G-6558



Austral antracita estructurado preincisión 3,5x60
29,75 x 59,55 cm - 11.71" x 23.45"
G-6486



Austral antracita estructurado rodapié 30
7,3 x 29,75 cm - 2.87" x 11.71"
G-5075



Austral antracita estructurado rodapié 60
7,3 x 59,55 cm - 2.87" x 23.45"
G-5097

STEPS.GRADINI.PELDAÑOS

TYPE	DESCRIPTION	SIZE	CODE
SIMPLE	peldaño simple-30	30x60 cm	5171
	peldaño simple-60	30x60 cm	5171
	peldaño simple áng	30x60 cm	5187
	peldaño simple-90	45x90 cm	5323
	peldaño simple áng	45x90 cm	5333
GRADONE	peldaño grad-30	30x60 cm	5559
	peldaño grad-60	30x60 cm	5559
	peldaño grad. áng	30x60 cm	5609
	peldaño grad-90	45x90 cm	5623
	peldaño grad. áng	45x90 cm	5645















+ INFO pag. 207

Austral natural

CLASE 1

UNE - ENV 12633

TECHNICAL CHARACTERISTICS. CARATTERISTICHE TECNICHE. CARACTERÍSTICAS TÉCNICAS

MEASUREMENTS AND SURFACES APPEARANCE / DIMENSIONI E ASPETTO SUPERFICIALE / MEDIDAS Y ASPECTO SUPERFICIAL / MASSEN UND AUSSEHEN DER OBERFLÄCHE		STANDARD TEST METHOD METODO DELLA NORMA METODO DE ENSAYO STANDARD TEST METHOD	STANDARD PRESCRIBED VALUES VALORE PRESCRITTO VALORES STANDARD NORMA STANDARDWERTE	AUSTRAL collection *
 Length and width. <i>Lunghezza e larghezza.</i> Longitud y anchura. Länge und Breite		ISO 10545-2	± 0,6% max.	± 0,2%
 Thickness. <i>Spessore.</i> Grosor. Stärke		ISO 10545-2	± 5% max.	± 2%
 90° Orthogonality. <i>Ortogonalità.</i> Ortogonalidad. Rechtwinkligkeit		ISO 10545-2	± 0,6% max.	± 0,2%
 Straightness of sides. <i>Rettilinearità dei lati.</i> Rectitud de lados. Kantengeradigkeit		ISO 10545-2	± 0,5% max.	± 0,2%
 Surfaces flatness. <i>Planarità.</i> Planitud. Ebenföchigkeit		ISO 10545-2	± 0,5% max.	± 0,2%
PHYSICAL PROPERTIES / PROPIETÀ FISICHE / PROPIEADADES FÍSICAS / PHYSIKALISCHE EIGENSCHAFTEN				
 Water absorption. <i>Assorbimento d' acqua.</i> Absorción de agua. Wasseraufnahme		ISO 10545-3	≤ 0,5%	≤ 0,1%
 Breaking strength, in N. <i>Carico di rottura, en N.</i> Carga de rotura, en N. Bruchlast, in N	thickness > 7,5 mm spessore > 7,5 mm grosor > 7,5 mm	ISO 10545-4	≥ 1300 N	2400 N *
 Modulus of rupture. <i>Resistenza alla flessione.</i> Resistencia a la flexión. Biegefestigkeit		ISO 10545-4	≥ 35 N/mm ²	56 N/mm ² *
 Resistance to deep abrasion. <i>Resistenza all' abrasione profonda.</i> Resistencia a la abrasión profunda. Tiefverschleissbeständigkeit		ISO 10545-6	≤ 175 mm ³	106 mm ³ *
 Resistance to thermal shock. <i>Resistenza agli sbalzi termici.</i> Resistencia al choque térmico. Temperaturwechselbeständigkeit		ISO 10545-9	No surface defects should be visible Non deve presentare difetti visibili No debe presentar defectos superficiales visibles	Resistant. Resistente. Resistente
 Resistance to frost. <i>Resistenza al gelo.</i> Resistencia a la helada. Frostbeständigkeit		ISO 10545-12	No surface defects or cracks should be visible Non deve presentare difetti visibili No debe presentar defectos ni grietas superficiales visibles	Frost Resistant Antighiaccio Resistente a la Helada
 Coefficient of friction. <i>Resistenza allo scivolamento.</i> Coeficiente de fricción. Rutschfestigkeit		UNE - ENV 12633	WET TEST/ENSAYO EN HÚMEDO DRY TEST/ENSAYO EN SECO	Clase I ** Clase 3 ***
 Colour resistance to light. <i>Resistenza dei colori alla luce.</i> Resistencia del color a la luz. Lichtbeständigkeit der Farben		DIN 51094	There should be no colour variations Non deve presentare difetti visibili No debe presentar variaciones de color	No alterations to colour and shine Non presenta alterazioni di colori e lucentezza No presenta variaciones de color y brillo
CHEMICAL PROPERTIES / PROPIETÀ CHIMICHE / PROPIEADADES QUÍMICAS / CHEMISCHEN EIGENSCHAFTEN				
 Chemical resistance. <i>Resistenza agli agenti chimici.</i> Resistencia química. Chemikalienbeständigkeit		ISO 10545-13	Resistance to household cleaning products and swimmingpools salts. Resistencia a productos domésticos y sales para piscinas	Min. UB
 Resistance to staining. <i>Resistenza alle macchie.</i> Resistencia a las manchas. Fleckenbeständigkeit		ISO 10545-14	≥ 3	5

*The Land values are the average of different production consignments. For further detail information, please check with our commercial network. /
I valori dichiarati sono ottenuti da una media di prove effettuate su diverse produzioni. Per avere informazioni dettagliate consultare la rete commerciale /
Los valores declarados son el promedio obtenido a través de ensayos de diferentes producciones. Para la obtención de una información detallada consultar a la red comercial.

** Test realized in internal laboratory. Provare realizzato in laboratorio interno. Ensayo realizado en laboratorio interno.

*** Dry Test, according to document DA DB-SUA/3 (Código Técnico de la Edificación) M° de Fomento. Average test result value, on May 2012.
Ensayo realizado, según documento DA DB-SUA/3 (Código Técnico de la edificación) M° de Fomento, valor medio a fecha Mayo 2012.



AUSTRAL

Austral Copper Estructurado
44,63x89,46 cm - 22,21x89,46 cm
29,75x59,55 cm

LAS TABLADILLAS COLLEGE
Sevilla. (SPAIN)
Arch. IMBRICE ARQUITECTOS

LEGNO



WOOD



* Legno noce. Content of recycled material. Contenido de material reciclado.

FORMATS.FORMATI.FORMATOS



45X90
44,63x89,46 cm - 17.57"x35.22"



15X90
14,74x89,46 cm - 5.80"x35.22"

SPECIAL PIECES.PEZZI SPECIALI.PIEZAS ESPECIALES



15X90 UP
14,74x88,80 cm - 5.80"x34.96"



15X90 Preincisión irregular
14,74x89,46 cm - 5.80"x35.22"



30X30 mosaico 5x5
29,75x29,75 cm - 11.71"x11.71"



Rodapié
7,3x44,63 cm - 2.92"x17.57"

THICKNESS.SPESORE.ESPESORES

 1,11 cm / 0.43" approx.

COLOURS COLORI COLORES



Ice



Noce

FINISHES FINITURI ACABADOS



Estructurado

LEGNO ice

PLAIN TILES.BASE.BASES



Legno ice
44,63x89,46 cm - 17.57"x35.22"
G-6194



Legno ice
14,74x89,46 cm - 5.80"x35.22"
G-6240

SPECIAL PIECES.PEZZI SPECIALI.PIEZAS ESPECIALES



Legno ice mosaico 5x5
29,75 x 29,75 cm - 11.71" x 11.71"
G-6644



Legno ice rodapié
7,3 x 44,63 cm - 2.87" x 17.57"
G-5085



Legno ice preincisión irregular
14,74x89,46 cm - 5.80"x35.22"
G-5211



Legno ice
14,74x88,80 cm - 5.80"x35.22"
G-5265

* This is a natural product made through a handmade process, therefore, its possible shade or size variations must be considered as typical features of the material and they will not be admitted in a claim.
Este es un producto natural fabricado artesanalmente, por lo que posibles variaciones de tono o dimensión deben considerarse propias del material y no será objeto de reclamación.

* INFO pag 208

STEPS.GRADINI.PELDAÑOS

SIMPLE 

GRADONE 

pedaño simple 45 (45x90 cm)	5303
pedaño simple 90 (45x90 cm)	5303
pedaño simple áng. (45x90 cm)	5315

pedaño grad-45 (45x90 cm)	5603
pedaño grad-90 (45x90 cm)	5605
pedaño grad áng (45x90 cm)	5623

Legno

CLASE 1	R10	DCOF>0.42
UNE - ENV 12633	DIN 51130	ANSI A 137.1 - 2012



LEGN0

Legno Ice 14,74x89,46 cm - Nouveau Dark Grey Nat. 29,75x29,75 cm

LEGNO **noce**

PLAIN TILES.BASE.BASES



Legno noce
44,63x89,46 cm - 17.57"x35.22"
G-6194



Legno noce
14,74x89,46 cm - 5.80"x35.22"
G-6240

SPECIAL PIECES.PEZZI SPECIALI.PIEZAS ESPECIALES



Legno noce mosaico 5x5
29,75 x 29,75 cm - 11.71" x 11.71"
G-6644



Legno noce rodapié
7,3 x 44,63 cm - 2.87" x 17.57"
G-5085



Legno noce preicisión irregular
14,74x89,46 cm - 5.80"x35.22"
G-5211



Legno noce
14,74x88,80 cm - 5.80"x35.22"
G-5265

* This is a natural product made through a handmade process, therefore, its possible shade or size variations must be considered as typical features of the material and they will not be admitted in a claim.
Este es un producto natural fabricado artesanalmente, por lo que posibles variaciones de tono o dimension deben considerarse propias del material y no será objeto de reclamación.

+ INFO pag 208

STEPS.GRADINI.PELDAÑOS

SIMPLE 

GRADONE 

peldaño simple 45 (45x90 cm)	5303
peldaño simple 90 (45x90 cm)	5303
peldaño simple áng. (45x90 cm)	5315

peldaño grad-45 (45x90 cm)	5603
peldaño grad-90 (45x90 cm)	5605
peldaño grad áng (45x90 cm)	5623

Legno















CLASE 1	R10	DCOF>0.42
UNE - ENV 12633	DIN 51130	ANSI A 137.1 - 2012



LEGN0

Legno Noce 14,74x89,46 cm - Nouveau Random Grey Nat. 29,75x29,75 cm

TECHNICAL CHARACTERISTICS. CARATTERISTICHE TECNICHE. CARACTERÍSTICAS TÉCNICAS

MEASUREMENTS AND SURFACES APPEARANCE / DIMENSIONI E ASPETTO SUPERFICIALE / MEDIDAS Y ASPECTO SUPERFICIAL / MASSEN UND AUSSEHEN DER OBERFLÄCHE		STANDARD TEST METHOD METODO DELLA NORMA METODO DE ENSAYO STANDARD TEST METHOD	STANDARD PRESCRIBED VALUES VALORE PRESCRITTO VALORES STANDARD NORMA STANDARDWERTE	LENGNO collection *
 Length and width. <i>Lunghezza e larghezza.</i> Longitud y anchura. Länge und Breite		ISO 10545-2	± 0,6% max.	± 0,1% *
 Thickness. <i>Spessore.</i> Grosor. Stärke		ISO 10545-2	± 5% max.	± 2%
 Orthogonality. <i>Ortogonalità.</i> Ortogonalidad. Rechtwinkligkeit		ISO 10545-2	± 0,6% max.	± 0,2% *
 Straightness of sides. <i>Rettilinearità dei lati.</i> Recutud de lados. Kantengeradigkeit		ISO 10545-2	± 0,5% max.	± 0,2% *
 Surfaces flatness. <i>Planarità.</i> Planitud. Ebenflächigkeit		ISO 10545-2	± 0,5% max.	± 0,2% *
PHYSICAL PROPERTIES / PROPRIETÀ FISICHE / PROPIEDADES FÍSICAS / PHYSIKALISCHE EIGENSCHAFTEN				
 Water absorption. <i>Assorbimento d'acqua.</i> Absorción de agua. Wasseraufnahme		ISO 10545-3	≤ 0,5%	≤ 0,1%
 Breaking strength, in N. <i>Carico di rottura, en N.</i> Carga de rotura, en N. Bruchlast, in N	thickness > 7,5 mm spessore > 7,5 mm grösor > 7,5 mm	ISO 10545-4	≥ 1300 N	2400 N *
 Modulus of rupture. <i>Resistenza alla flessione.</i> Resistencia a la flexión. Biegefestigkeit		ISO 10545-4	≥ 35 N/mm ²	56 N/mm ² *
 Resistance to deep abrasion. <i>Resistenza all'abrasione profonda.</i> Resistencia a la abrasión profunda. Tiefverschleissbeständigkeit		ISO 10545-6	≤ 175 mm ³	115 mm ³ *
 Resistance to thermal shock. <i>Resistenza agli sbalzi termici.</i> Resistencia al choque térmico. Temperaturwechselbeständigkeit		ISO 10545-9	No surface defects should be visible Non deve presentare difetti visibili No debe presentar defectos superficiales visibles	Resistant. Resistente. Resistente
 Frost resistance. <i>Resistenza al gelo.</i> Resistencia a la helada. Frostbeständigkeit		ISO 10545-12	No surface defects or cracks should be visible Non deve presentare difetti visibili No debe presentar defectos ni grietas superficiales visibles	Frost Resistance Antighiaccio Resistente a la Helada
 Coefficient of friction. <i>Resistenza allo scivolamento.</i> Coeficiente de fricción. Rutschfestigkeit		DIN 51130 UNE - ENV 12633	WET TEST/ENSAYO EN HÚMEDO DRY TEST/ENSAYO EN SECO	R10** Clase 1 *** Clase 3 **** DCOF - ANSIA 137.1-2012 > 0.42
 Colour resistance to light. <i>Resistenza dei colori alla luce.</i> Resistencia del color a la luz. Lichtbeständigkeit der Farben		DIN 51094	There should be no colour variations Non deve presentare difetti visibili No debe presentar variaciones de color	No alterations in colour and shine Non presentar alterazione di colori e lucidità No presenta variaciones de color y brillo
CHEMICAL PROPERTIES / PROPRIETÀ CHIMICHE / PROPIEDADES QUÍMICAS / CHEMISCHEN EIGENSCHAFTEN				
 Chemical resistance. <i>Resistenza agli agenti chimici.</i> Resistencia química. Chemikalienbeständigkeit		ISO 10545-13	Resistance to household cleaning products and swimming pools salts. Resistencia a productos domésticos y sales para piscinas	Min. UB
 Resistance to staining. <i>Resistenza alle macchie.</i> Resistencia a las manchas. Fleckenbeständigkeit		ISO 10545-14	≥ 3	5 *

*The Land values are the average of different production consignments. For further detail information, please check with our commercial network. / I valori dichiarati sono ottenuti da una media di prove effettuate su diverse produzioni. Per avere informazioni dettagliate consultare la rete commerciale / Los valores declarados son el promedio obtenido a través de ensayos de diferentes producciones. Para la obtención de una información detallada consultar a la red comercial.

** R10 - Tested in Legno Noce (batch: 06-14-2014). It depends on the consignment. / Provare realizzato in Legno noce (partita: 14-06-2014). / Ensayo realizado sobre Legno Noce (lote: 14-06-2014).

*** Clase 1 - Tested in Legno Noce (It depends on the consignment) Test realized in internal laboratory / Provare realizzato in laboratorio interno / Ensayo realizado en laboratorio interno.

**** Dry Test, according to document DA DB-SUA/3 (Código Técnico de la Edificación) M° de Fomento. Test done in LEGNO NOCE 15X90 on October 2014. Ensayo realizado, según documento DA DB-SUA/3 (Código Técnico de la edificación) M° de Fomento, sobre el producto LEGNO NOCE 15X90 a fecha octubre 2014



¿Por qué
-Es un viaje de descubrimiento
-Perseguir
-El arte
el despegue
momento de un cambio.

LEGNO

Legno Noce 44,63x89,46 cm

LEGNO SLIM



WOOD



* Legno slim noce. Content of recycled material. Contenido de material reciclado.

FORMATS.FORMATI.FORMATOS



30X90
29,75x89,46 cm - 11.71"x35.22"

THICKNESS.SPESORE.ESPESORES

≡ 0,48 cm / 0.19" approx.

COLOURS
COLORI
COLORES



Noce



Titanium

FINISHES
FINITURI
ACABADOS



Estructurado

LEGNO SLIM

LEGNO SLIM **noce - titanium**

PLAIN TILES.BASE.BASES



Legno slim noce *
29,75 x 89,46 cm - 11.71" x 35.22"
G-6246



Legno slim titanium *
29,75 x 89,46 cm - 11.71" x 35.22"
G-6284

* 3 Different aleatory reliefs.
3 Relieves diferentes aleatorios



LEGNO SLIM

Legno Slim Titanium 29,75x89,46 cm - Portland Slim Vison Nat. 29,75x89,46 cm

TECHNICAL CHARACTERISTICS. CARATTERISTICHE TECNICHE. CARACTERÍSTICAS TÉCNICAS

MEASUREMENTS AND SURFACES APPEARANCE / DIMENSIONI E ASPETTO SUPERFICIALE / MEDIDAS Y ASPECTO SUPERFICIAL / MASSEN UND AUSSEHEN DER OBERFLÄCHE		STANDARD TEST METHOD METODO DELLA NORMA METODO DE ENSAYO STANDARD TEST METHOD	STANDARD PRESCRIBED VALUES VALORE PRESCRITTO VALORES STANDARD NORMA STANDARDWERTE	LEGNO SLIM *
Length and width. <i>Lunghezza e larghezza.</i> Longitud y anchura. Länge und Breite		ISO 10545-2	± 0,6% max.	± 0,2% *
Orthogonality. <i>Ortogonalità.</i> Ortogonalidad. Rechtwinkligkeit		ISO 10545-2	± 0,6% max.	± 0,2% *
Straightness of sides. <i>Rettilinearità dei lati.</i> Rectitud de lados. Kantengeradigkeit		ISO 10545-2	± 0,5% max.	± 0,2% *
Surfaces flatness. <i>Planarità.</i> Planitud. Ebenföchigkeit		ISO 10545-2	± 0,5% max.	± 0,2% *
PHYSICAL PROPERTIES / PROPIETÀ FISICHE / PROPIEDADES FÍSICAS / PHYSIKALISCHE EIGENSCHAFTEN				
Water absorption. <i>Assorbimento d'acqua.</i> Absorción de agua. Wasseraufnahme		ISO 10545-3	≤ 0,5%	≤ 0,1%
Breaking strength, in N. <i>Carico di rottura, en N.</i> Carga de rotura, en N. Bruchlast, in N	thickness <75 mm spessore <7,5 mm grosor <75 mm	ISO 10545-4	≥ 700 N	Available Method * Metodo Disponibile Método Disponible
Modulus of rupture. <i>Resistenza alla flessione.</i> Resistencia a la flexión. Biegefestigkeit		ISO 10545-4	≥ 35 N/mm ²	>40 N/mm ² *
Resistance to thermal shock. <i>Resistenza agli sbalzi termici.</i> Resistencia al choque térmico. Temperaturwechselbeständigkeit		ISO 10545-9	No surface defects should be visible Non deve presentare difetti visibili No debe presentar defectos superficiales visibles	Resistant. Resistente. Resistente
Frost resistance. <i>Resistenza al gelo.</i> Resistencia a la helada. Frostbeständigkeit		ISO 10545-12	No surface defects or cracks should be visible Non deve presentare difetti visibili No debe presentar defectos ni grietas superficiales visibles	Frost Resistant Antighaccio Resistente a la Helada
Coefficient of friction. <i>Resistenza allo scivolamento.</i> Coeficiente de fricción. Rutschfestigkeit		DIN 51130		Available Method Método Disponible Método Disponible
Colour resistance to light. <i>Resistenza dei colori alla luce.</i> Resistencia del color a la luz. Lichtbeständigkeit der Farben		DIN 51094	There should be no colour variations Non deve presentare difetti visibili No debe presentar variaciones de color	No alterations in colour and shine Non presentar alterazioni di colore e lucentezza No presenta variaciones de color y brillo
CHEMICAL PROPERTIES / PROPIETÀ CHIMICHE / PROPIEDADES QUÍMICAS / CHEMISCHEN EIGENSCHAFTEN				
Chemical resistance. <i>Resistenza agli agenti chimici.</i> Resistencia química. Chemikalienbeständigkeit		ISO 10545-13	Resistance to household cleaning products and swimmingpools salts. Resistenza a prodotti d'igiene e sale per piscine	Min.GB
Resistance to staining. <i>Resistenza alle macchie.</i> Resistencia a las manchas. Fleckenbeständigkeit		ISO 10545-14	≥ 3	5 **

*The Land values are the average of different production consignments. For further detail information, please check with our commercial network. /
I valori dichiarati sono ottenuti da una media di prove effettuate su diverse produzioni. Per avere informazioni dettagliate consultare la rete commerciale /
Los valores declarados son el promedio obtenido a través de ensayos de diferentes producciones. Para la obtención de una información detallada consultar a la red comercial.

** Tested in LegnoSlim Noce. Test realized in internal laboratory. Legno Slim Titanium - Metallized finish. For projects check technical information with our commercial networks. /
Prova realizzata in laboratorio interno su Legno Slim Noce. Legno Slim Titanium - finitura metallica. Per avere informazioni dettagliate consultare la rete commerciale. /
Ensayo realizado en laboratorio interno sobre Legno Slim Noce. Legno Slim Titanium - acabado metalizado. Para proyectos obtenga información técnica a través de nuestra red comercial.

ADVANTAGES. VANTAGGI. VENTAJAS

- Time. *Tempo.* Tiempo
- Money. *Denaro.* Dinero
- Hygiene. *Igiene.* Higiene
- Ecologic. *Ecologia.* Ecología
- Technology. *Tecnologia.* Tecnología

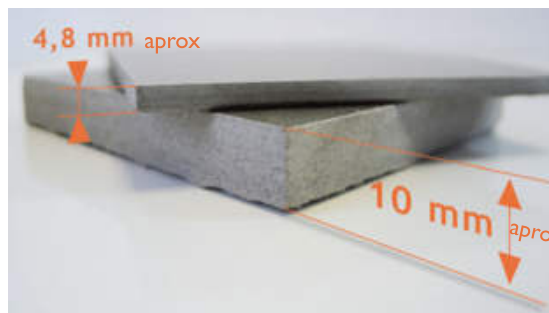

* Recommended only for wall. /
sólo recomendado como revestimiento.



WV
hotels

LEGNO SLIM

Legno Slim Noce - Titanium 29,75x89,46 cm

ROOTS



WOOD



* Roots maple. Content of recycled material. Contenido de material reciclado.

FORMATS.FORMATI.FORMATOS



60X120
59,55x119,3 cm - 23.45"x46.97"



20X120
19,71x119,3 cm - 7.76"x46.97"



30X120
29,67x119,3 cm - 11.68"x46.97"



15X120
14,73x119,3 cm - 5.80"x46.97"

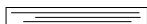

7,5X60 listelo A
7,3x59,55 cm - 2.87"x23.45"



7,5X60 listelo C
7,3x59,55 cm - 2.87"x23.45"

SPECIAL PIECES.PEZZI SPECIALI.PIEZAS ESPECIALES

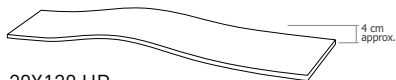

20X120 UP
19,71x118,80 cm - 7.76"x46.77"



30X30 mosaico 5x10
29,75x29,75 cm - 11.71"x11.71"



30X30 mosaico multicolor 5x10
29,75x29,75 cm - 11.71"x11.71"



30X30 módulo 15x15
29,75x29,75 cm - 11.71"x11.71"

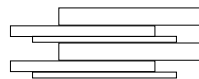

30X60 muretto
29,75x59,55 cm - 11.71"x23.45"



7,5X60 rodapié
7,3x59,55 cm - 2.87"x23.45"

THICKNESS.SPESORE.ESPESORES

 1,18 cm / 0.46" approx.

COLOURS COLORI COLORES



White



Maple



Oak

FINISHES FINITURI ACABADOS



Estructurado

ROOTS **white**

PLAIN TILES.BASE.BASES



Roots white
59,55 x 119,3 cm - 23.45" x 46.97"
G-6466



Roots white
29,67 x 119,3 cm - 7.76" x 46.97"
G-6496



Roots white
19,71 x 119,3 cm - 7.76" x 46.97"
G-6496



Roots white
14,73 x 119,3 cm - 5.80" x 46.97"
G-6496

* This is a natural product made through a handmade process, therefore, its possible shade or size variations must be considered as typical features of the material and they will not be admitted in a claim.
Este es un producto natural fabricado artesanalmente, por lo que posibles variaciones de tono o dimension deben considerarse propias del material y no será objeto de reclamación.

Roots **CLASE 3** **R11** **DCOF>0.42**
UNE - ENV 12633 DIN 51130 ANSI A 137.1 - 2012

SPECIAL PIECES.PEZZI SPECIALI.PIEZAS ESPECIALES

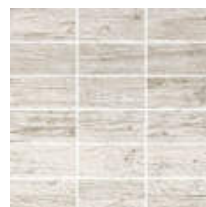

Roots white mosaico 5x10
29,75 x 29,75 cm - 11.71" x 11.71"
G-6756



Roots multicolor mosaico 5x10
29,75 x 29,75 cm - 11.71" x 11.71"
G-6756



Roots módulo 15x15
29,75 x 29,75 cm - 11.71" x 11.71"
G-5243



Roots white muretto
29,75 x 59,55 cm - 11.71" x 23.45"
G-6756



Roots white rodapié 60
7,3 x 59,55 cm - 2.87" x 23.45"
G-5097



Roots white up*
19,71 x 118,8 cm - 7.76" x 46.77"
G-5435

+ INFO pag. 208



Roots white listelo A
7,3 x 59,55 cm - 2.87" x 23.45"
G-5089



Roots white listelo C
7,3 x 59,55 cm - 2.87" x 23.45"
G-5089

STEPS.GRADINI.PELDAÑOS

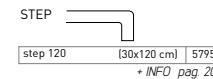
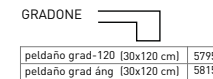
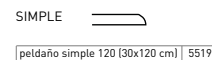



ROOTS

Roots White 14,73x119,3cm_Roots Maple Mosaico 5x10_Roots Modulo 15x15

ROOTS maple

PLAIN TILES.BASE.BASES



Roots maple
59,55 x 119,3 cm - 23.45" x 46.97"
G-6466



Roots maple
29,67 x 119,3 cm - 7.76" x 46.97"
G-6496



Roots maple
19,71 x 119,3 cm - 7.76" x 46.97"
G-6496



Roots maple
14,73 x 119,3 cm - 5.80" x 46.97"
G-6496

* This is a natural product made through a handmade process, therefore, its possible shade or size variations must be considered as typical features of the material and they will not be admitted in a claim.
Este es un producto natural fabricado artesanalmente, por lo que posibles variaciones de tono o dimension deben considerarse propias del material y no será objeto de reclamación.

Roots **CLASE 3** **R11** **DCOF>0.42**
UNE - ENV 12633 DIN 51130 ANSI A 137.1 - 2012

SPECIAL PIECES.PEZZI SPECIALI.PIEZAS ESPECIALES

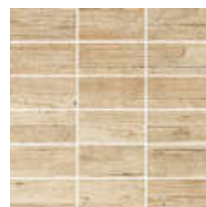

Roots maple mosaico 5x10
29,75 x 29,75 cm - 11.71" x 11.71"
G-6756



Roots multicolor mosaico 5x10
29,75 x 29,75 cm - 11.71" x 11.71"
G-6756



Roots módulo 15x15
29,75 x 29,75 cm - 11.71" x 11.71"
G-5243



Roots maple muretto
29,75 x 59,55 cm - 11.71" x 23.45"
G-6756



Roots maple rodapié 60
7,3 x 59,55 cm - 2.87" x 23.45"
G-5097



Roots maple up*
19,71 x 118,8 cm - 7.76" x 46.77"
G-5435

+ INFO pag. 208





Roots maple listelo A
7,3 x 59,55 cm - 2.87" x 23.45"
G-5089



Roots maple listelo C
7,3 x 59,55 cm - 2.87" x 23.45"
G-5089

STEPS.GRADINI.PELDAÑOS

SIMPLE 
peldaño simple 120 (30x120 cm) 5519

GRADONE 
peldaño grad-120 (30x120 cm) 5795
peldaño grad áng (30x120 cm) 5815

STEP 
step 120 (30x120 cm) 5795
+ INFO pag. 207



ROOTS

Roots Maple 14,73x119,3 cm - 19,71x119,3 cm - 29,67x119,3 cm

ROOTS oak

PLAIN TILES.BASE.BASES



Roots oak
59,55 x 119,3 cm - 23.45" x 46.97"
G-6466



Roots oak
29,67 x 119,3 cm - 7.76" x 46.97"
G-6496



Roots oak
19,71 x 119,3 cm - 7.76" x 46.97"
G-6496



Roots oak
14,73 x 119,3 cm - 5.80" x 46.97"
G-6496

* This is a natural product made through a handmade process, therefore, its possible shade or size variations must be considered as typical features of the material and they will not be admitted in a claim.
Este es un producto natural fabricado artesanalmente, por lo que posibles variaciones de tono o dimension deben considerarse propias del material y no será objeto de reclamación.

Roots **CLASE 3** **R11** **DCOF>0.42**
UNE - ENV 12633 DIN 51130 ANSI A 137.1 - 2012

SPECIAL PIECES.PEZZI SPECIALI.PIEZAS ESPECIALES

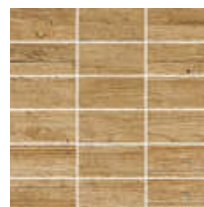

Roots oak mosaico 5x10
29,75 x 29,75 cm - 11.71" x 11.71"
G-6756



Roots multicolor mosaico 5x10
29,75 x 29,75 cm - 11.71" x 11.71"
G-6756



Roots módulo 15x15
29,75 x 29,75 cm - 11.71" x 11.71"
G-5243



Roots oak muretto
29,75 x 59,55 cm - 11.71" x 23.45"
G-6756



Roots oak rodapié 60
7,3 x 59,55 cm - 2.83" x 23.45"
G-5097



Roots oak up
19,71 x 118,8 cm - 7.76" x 46.77"
G-5435
+ INFO pag. 208



Roots oak listelo A
7,3 x 59,55 cm - 2.87" x 23.45"
G-5089



Roots oak listelo C
7,3 x 59,55 cm - 2.87" x 23.45"
G-5089

STEPS.GRADINI.PELDAÑOS

SIMPLE
peldaño simple 120 (30x120 cm) 5519

GRADONE
peldaño grad-120 (30x120 cm) 5795
peldaño grad áng (30x120 cm) 5815















STEP
step 120 (30x120 cm) 5795
+ INFO pag. 221



ROOTS

Roots Oak 29,67x119,3 cm / Roots Oak Gradone 29,67x119,3 cm

TECHNICAL CHARACTERISTICS. CARATTERISTICHE TECNICHE. CARACTERÍSTICAS TÉCNICAS

MEASUREMENTS AND SURFACES APPEARANCE / DIMENSIONI E ASPETTO SUPERFICIALE / MEDIDAS Y ASPECTO SUPERFICIAL / MASSEN UND AUSSEHEN DER OBERFLÄCHE		STANDARD TEST METHOD METODO DELLA NORMA METODO DE ENSAYO STANDARD TEST METHOD	STANDARD PRESCRIBED VALUES VALORE PRESCRITTO VALORES STANDARD NORMA STANDARDWERTE	ROOTS collection *
 Length and width. <i>Lunghezza e larghezza.</i> Longitud y anchura. Länge und Breite		ISO 10545-2	± 0,6% max.	± 0,1% *
 Thickness. <i>Spessore.</i> Grosor. Stärke		ISO 10545-2	± 5% max.	± 2% *
 90° Orthogonality. <i>Ortogonalità.</i> Ortogonalidad. Rechtwinkligkeit		ISO 10545-2	± 0,6% max.	± 0,2% *
 Straightness of sides. <i>Rettilinearità dei lati.</i> Rectitud de lados. Kantengeradigkeit		ISO 10545-2	± 0,5% max.	± 0,2% *
 Surfaces flatness. <i>Planarità.</i> Planitud. Ebenföchigkeit		ISO 10545-2	± 0,5% max.	± 0,2% *
PHYSICAL PROPERTIES / PROPIETÀ FISICHE / PROPIEDADES FÍSICAS / PHYSIKALISCHE EIGENSCHAFTEN				
 Water absorption. <i>Assorbimento d' acqua.</i> Absorción de agua. Wasseraufnahme		ISO 10545-3	≤ 0,5%	≤ 0,1%
 Breaking strength, in N. <i>Carico di rottura, en N.</i> Carga de rotura, en N. Bruchlast, in N	thickness > 7,5 mm spessore > 7,5 mm grosor > 7,5 mm	ISO 10545-4	≥ 1300 N	2400 N *
 Modulus of rupture. <i>Resistenza alla flessione.</i> Resistencia a la flexión. Biegefestigkeit		ISO 10545-4	≥ 35 N/mm ²	56 N/mm ² *
 Resistance to deep abrasion. <i>Resistenza all' abrasione profonda.</i> Resistencia a la abrasion profunda. Tiefverschleissbeständigkeit		ISO 10545-6	≤ 175 mm ³	110 mm ³ *
 Resistance to thermal shock. <i>Resistenza agli sbalzi termici.</i> Resistencia al choque térmico. Temperaturwechselbeständigkeit		ISO 10545-9	No surface defects should be visible Non deve presentare difetti visibili No debe presentar defectos superficiales visibles	Resistant. Resistente. Resistente
 Frost resistance. <i>Resistenza al gelo.</i> Resistencia a la helada. Frostbeständigkeit		ISO 10545-12	No surface defects or cracks should be visible Non deve presentare difetti visibili No debe presentar defectos ni grietas superficiales visibles	Frost Resistance Antighaccio Resistente a la Helada
 Coefficient of friction. <i>Resistenza allo scivolamento.</i> Coeficiente de fricción. Rutschfestigkeit		DIN 51130 UNE - ENV 12633	WET TEST/ENSAYO EN HÚMEDO DRY TEST/ENSAYO EN SECO	R11** Clase 3 ** Clase 3*** DCOF - ANSIA 137.1-2012 > 0.42
 Colour resistance to light. <i>Resistenza dei colori alla luce.</i> Resistencia del color a la luz. Lichtbeständigkeit der Farben		DIN 51094	There should be no colour variations Non deve presentare difetti visibili No debe presentar variaciones de color	No alterations in colour and shine Non presenta alterazioni di colori e lucentezza No presenta variaciones de color y brillo
CHEMICAL PROPERTIES / PROPIETÀ CHIMICHE / PROPIEDADES QUÍMICAS / CHEMISCHEN EIGENSCHAFTEN				
 Chemical resistance. <i>Resistenza agli agenti chimici.</i> Resistencia química. Chemikalienbeständigkeit		ISO 10545-13	Resistance to household cleaning products and swimmingpools salts. Resistencia a productos domesticos y sales para piscinas	Min UB
 Resistance to staining. <i>Resistenza alle macchie.</i> Resistencia a las manchas. Fleckenbeständigkeit		ISO 10545-14	≥ 3	5 *

*The Land values are the average of different production consignments. For further detail information, please check with our commercial network. / I valori dichiarati sono ottenuti da una media di prove effettuate su diverse produzioni. Per avere informazioni dettagliate consultare la rete commerciale / Los valores declarados son el promedio obtenido a través de ensayos de diferentes producciones. Para la obtención de una información detallada consultar a la red comercial.

** R11 - Test carried out on Roots Maple 30x120 (Batch 30-05-13). Ensayo realizado sobre el producto Roots Maple 30x120 (Lote 30-05-13)

** Clase 3 - Test carried out on Roots Maple 30x120, on June 2013. Test realized in internal laboratory. Ensayo realizado en laboratorio interno.

** TESTED ON SAMPLES FROM FIRST PRODUCTION BATCH. PLEASE CHECK SPECIFIC VALUE WITH OUR COMMERCIAL NETWORK BEFORE CONFIRMING THE ORDER.

ENSAYOS REALIZADOS EN PRIMERA PRODUCCIÓN, CONSULTAR DATOS DEL PRODUCTO ESPECÍFICO ANTES DE CONFIRMAR EL PEDIDO PARA PROYECTOS QUE PRECISEN DICHS VALORES.

*** Dry Test, according to document DA DB-SUA/3 (Código Técnico de la Edificación) M° de Fomento. Average test result value, on May 2012.

Ensayo realizado, según documento DA DB-SUA/3 (Código Técnico de la edificación) M° de Fomento. Valor medio a fecha Mayo 2012.



ROOTS

Roots maple 19,71x119,3 cm

MENSA



WOOD



COSTA AZUL HOTEL ****
Palma de Mallorca. (SPAIN)
Arch. Juan de Luna



CASA ANA COFFEE SHOP
Castellón. (SPAIN)

* Mensa savanna. Content of recycled material. Contenido de material reciclado.

FORMATS.FORMATI.FORMATOS



45X90

44,63x89,46 cm - 17.57"x35.22"



22,5X90

22,21x89,46 cm - 8.75"x35.22"

SPECIAL PIECES.PEZZI SPECIALI.PIEZAS ESPECIALES



7,5X45 rodapié

7,3x44,63 cm - 2.87"x17.57"

THICKNESS.SPESORE.ESPESORES

 1,11 cm / 0.44" approx.

COLOURS COLORI COLORES

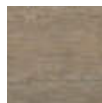

Savanna



Graphite

FINISHES FINITURI ACABADOS



Natural

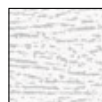

Non-slip

MENSA

MENSA savanna - graphite

PLAIN TILES.BASE.BASES



Mensa savanna
44,63 x 89,46 cm - 17.57" x 35.22"
G-6330



Mensa graphite
44,63 x 89,46 cm - 17.57" x 35.22"
G-6330



Mensa savanna
22,21 x 89,46 cm - 8.75" x 35.22"
G-6392



Mensa graphite / non slip
22,21 x 89,46 cm - 8.75" x 35.22"
G-6392 / 6416

SPECIAL PIECES.
PEZZI SPECIALI.PIEZAS ESPECIALES





Mensa savanna rodapié 45
7,3 x 44,63 cm - 2.87" x 17.57"
G-5087



Mensa graphite rodapié 45
7,3 x 44,63 cm - 2.87" x 17.57"
G-5087

STEPS.GRADINI.PELDAÑOS

SIMPLE		peldaño simple-90 (45x90 cm) <small>natural</small>	5315
		peldaño áng. 90 (45x90 cm)	5323
GRADONE		peldaño grad-90 (45x90 cm) <small>natural</small>	5623
		peldaño grad. áng. (45x90 cm)	5645

+ INFO pag. 221

Mensa non slip **CLASE 3**
UNE - ENV 12633

Mensa natural **CLASE 1**
UNE - ENV 12633

















MENSA

Mensa Savanna 22,21x89,46 cm

PHARMACY
Barcelona. (SPAIN)

TECHNICAL CHARACTERISTICS. CARATTERISTICHE TECNICHE. CARACTERÍSTICAS TÉCNICAS

MEASUREMENTS AND SURFACES APPEARANCE / DIMENSIONI E ASPETTO SUPERFICIALE / MEDIDAS Y ASPECTO SUPERFICIAL / MASSES UND AUSSEHEN DER OBERFLÄCHE		STANDARD TEST METHOD METODO DELLA NORMA METODO DE ENSAYO STANDARD TEST METHOD	STANDARD PRESCRIBED VALUES VALORE PRESCRITTO VALORES STANDARD NORMA STANDARDWERTE	MENSA collection *
 Length and width. <i>Lunghezza e larghezza.</i> Longitud y anchura. Länge und Breite		ISO 10545-2	± 0,6% max.	± 0,1%
 Thickness. <i>Spessore.</i> Grosor. Stärke		ISO 10545-2	± 5% max.	± 2%
 Orthogonality. <i>Ortogonalità.</i> Ortogonalidad. Rechtwinkligkeit		ISO 10545-2	± 0,6% max.	± 0,2%
 Straightness of sides. <i>Rettilinearità dei lati.</i> Rectitud de lados. Kantengeradigkeit		ISO 10545-2	± 0,5% max.	± 0,2%
 Surfaces flatness. <i>Planarità.</i> Planitud. Ebenföchigkeit		ISO 10545-2	± 0,5% max.	± 0,2%
PHYSICAL PROPERTIES / PROPIETÀ FISICHE / PROPIEDADES FÍSICAS / PHYSIKALISCHE EIGENSCHAFTEN				
 Water absorption. <i>Assorbimento d'acqua.</i> Absorción de agua. Wasseraufnahme		ISO 10545-3	≤ 0,5%	0,1%
 Breaking strength, in N. <i>Carico di rottura, en N.</i> Carga de rotura, en N. Bruchlast, in N	thickness > 7,5 mm spessore > 7,5 mm grosor > 7,5 mm	ISO 10545-4	≥ 1300 N	2400 N*
 Modulus of rupture. <i>Resistenza alla flessione.</i> Resistencia a la flexión. Biegefestigkeit		ISO 10545-4	≥ 35 N/mm ²	52 N/mm ² *
 Resistance to deep abrasion. <i>Resistenza all'abrasione profonda.</i> Resistencia a la abrasión profunda. Tiefverschleissbeständigkeit		ISO 10545-6	≤ 175 mm ³	112 mm ³ *
 Resistance to thermal shock. <i>Resistenza agli sbalzi termici.</i> Resistencia al choque térmico. Temperaturwechselbeständigkeit		ISO 10545-9	No surface defects should be visible Non deve presentare difetti visibili No debe presentar defectos superficiales visibles	Resistant. Resistente. Resistente
 Frost resistance. <i>Resistenza al gelo.</i> Resistencia a la helada. Frostbeständigkeit		ISO 10545-12	No surface defects or cracks should be visible Non deve presentare difetti visibili No debe presentar defectos ni grietas superficiales visibles	Frost Resistant Antighiaccio Resistente a la Helada
 Coefficient of friction. <i>Resistenza allo scivolamento.</i> Coeficiente de fricción. Rutschfestigkeit		UNE - ENV 12633	WET TEST/ENSAYO EN HÚMEDO DRY TEST/ENSAYO EN SECO	Clase 1 - Clase 3** Clase 3***
 Colour resistance to light. <i>Resistenza dei colori alla luce.</i> Resistencia del color a la luz. Lichtbeständigkeit der Farben		DIN 51094	There should be no colour variations Non deve presentare difetti visibili No debe presentar variaciones de color	No alterations to colour and shine Non presenta alterazioni di colori e lucentezza No presenta variaciones de color y brillo
CHEMICAL PROPERTIES / PROPIETÀ CHIMICHE / PROPIEDADES QUÍMICAS / CHEMISCHEN EIGENSCHAFTEN				
 Chemical resistance. <i>Resistenza agli agenti chimici.</i> Resistencia química. Chemikalienbeständigkeit		ISO 10545-13	Resistance to household cleaning products and swimmingpool salts. Resistencia a productos domésticos y sales para piscinas	Min. UB
 Resistance to staining. <i>Resistenza alle macchie.</i> Resistencia a las manchas. Fleckenbeständigkeit		ISO 10545-14	≥ 3	5

*The Land values are the average of different production consignments. For further detail information, please check with our commercial network. / I valori dichiarati sono ottenuti da una media di prove effettuate su diverse produzioni. Per avere informazioni dettagliate consultare la rete commerciale / Los valores declarados son el promedio obtenido a través de ensayos de diferentes producciones. Para la obtención de una información detallada consultar a la red comercial.

** Clase 1 - Tested in natural finish. Test realized in internal laboratory. Provare realizzato in laboratorio interno. Ensayo realizado en laboratorio interno.

** Clase 3 - Tested in non slip finish. Test realized in internal laboratory. Provare realizzato in laboratorio interno. Ensayo realizado en laboratorio interno.

*** Dry Test, according to document DA DB-SUA/3 (Código Técnico de la Edificación) M° de Fomento. Average test result value, on May 2012. Ensayo realizado, según documento DA DB-SUA/3 (Código Técnico de la edificación) M° de Fomento, valor medio a fecha Mayo 2012.



MENSA

Mensa Savanna Non-slip 22,21x89,46 cm

COSTA AZUL HOTEL ****
Palma de Mallorca. [SPAIN]
Arch. Juan de Luna

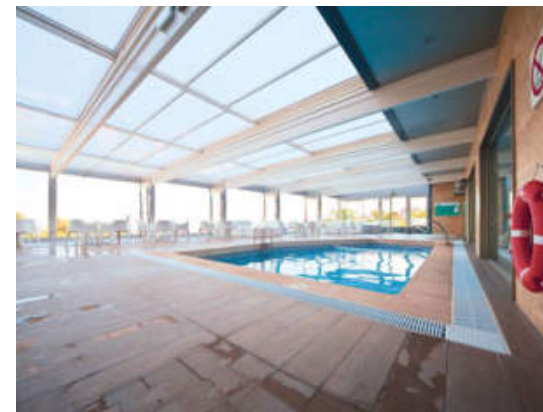
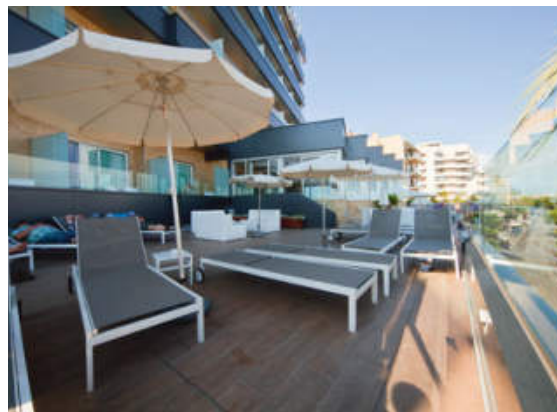

GALLERY



COLOURS



SANDWICH & FRIENDS RESTAURANT
Barcelona. (SPAIN)
Interior Design. AIXUT ALVARADO
DECORADORS



POLO DIREZIONALE DE CECCO
Pescara. (ITALY)
Arch. Massimiliano FUKSAS

* Gallery black sat. Content of recycled material. Contenido de material reciclado.

FORMATS.FORMATI.FORMATOS

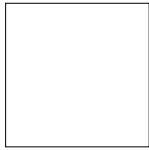

60X60
59,55x59,55 cm
23.45"x23.45"



30X60
29,75x59,55 cm - 11.71"x23.45"

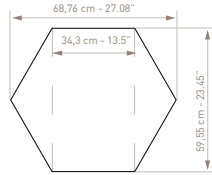

Hexagonal
59,55x51,57 cm
23.45"x20.31"

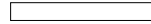

7,5X60
7,3x59,55 cm - 2.87"x23.45"

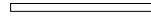

3,5X60
3,5x59,55 cm - 1.38"x23.45"



7,5X7,5
7,3x7,3 cm - 2.87"x2.87"

SPECIAL PIECES.PEZZI SPECIALI.PIEZAS ESPECIALES

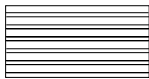

30X60 righe
29,75x59,55 cm - 11.71"x23.45"



30X30 mosaico 2,5x2,5
29,75x29,75 cm - 11.71"x11.71"

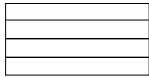

30X60 preincisión 7,5x60
29,75x59,55 cm - 11.71"x23.45"



30X30 mosaico 2,5x10
29,75x29,75 cm - 11.71"x11.71"

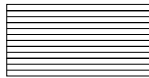

30X60 preincisión 2,5x60
29,75x59,55 cm - 11.71"x23.45"



30X60 b-insert
29,75x59,55 cm - 11.71"x23.45"



Inserto
R 12,5 cm - R 5"



7,5X60 rodapié
7,5X30 rodapié
7,3x59,55 cm - 2.87"x23.45"
7,3x29,75 cm - 2.87"x11.71"

THICKNESS.SPESSORE.ESPESORES

— 1,01 cm / 0.35" - 0.40" approx.

— 0,90 - 1,00 cm / 0.35" - 0.39" approx.

Hexagonal / 60x60cm FORMATS

30x60cm FORMAT

COLOURS COLORI COLORES

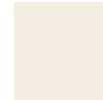

White



Yellow



Orange



Lime



Red



Blue



Black

FINISHES FINITURI ACABADOS



Polido



Satinado



Righe

GALLERY white

PLAIN TILES.BASE.BASES



Gallery white satinado hexagonal

59,55 x 51,57 cm - 23.45" x 20.31"

G-6558

3 mm joint are recommended for hexagonal sizes.
para formatos hexagonales se recomienda una junta de separación de 3 mm.

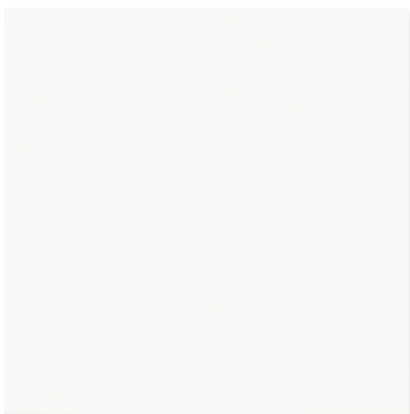

Gallery white pulido / satinado

59,55 x 59,55 cm - 23.45" x 23.45"

G-6516 / 6458

Gallery satinado

CLASE 1

UNE - ENV 12633

DCOF>0.42

ANSI A 137.1 - 2012

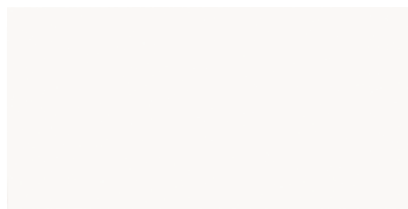

Gallery white pulido / satinado

29,75 x 59,55 cm - 11.71" x 23.45"

G-6456 / 6364



Gallery white righe

29,75 x 59,55 cm - 11.71" x 23.45"

G-6404

SPECIAL PIECES.PEZZI SPECIALI.PIEZAS ESPECIALES

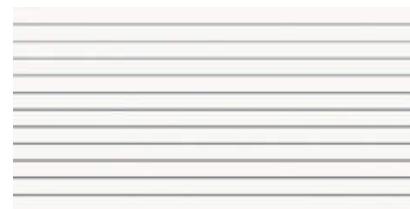

Gallery white pulido preincisión 2,5x60

29,75 x 59,55 cm - 11.71" x 23.45"

G-6666



Gallery white pulido preincisión 7,5x60

29,75 x 59,55 cm - 11.71" x 23.45"

G-6666

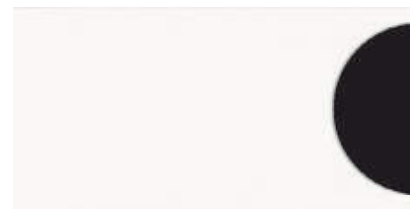

Gallery white satinado b-insert*

29,75 x 59,55 cm - 11.71" x 23.45"

G-5283

Gallery black satinado inserto*

R 12,8 cm - R 5"

G-5149



Gallery black satinado b-insert*

29,75 x 59,55 cm - 11.71" x 23.45"

G-5283

Gallery white satinado inserto*

R 12,8 cm - R 5"

G-5149

* insert and b-insert are sold separately. /
insert y b-insert se venden por separado.

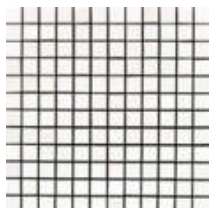

**Gallery white satinado
mosaico 2,5x2,5**
29,75 x 29,75 cm - 11.71" x 11.71"
G-6868

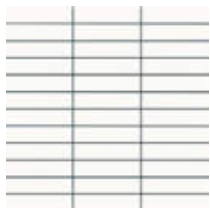

**Gallery white pulido
mosaico 2,5x10**
29,75 x 29,75 cm - 11.71" x 11.71"
G-6868



**Gallery white
pulido / satinado taco**
7,3 x 7,3 cm - 2.87" x 2.87"
G-5027 / 5025

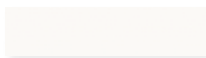

Gallery white pulido listelo-30
7,3 x 29,75 cm - 2.87" x 11.71"
G-5075

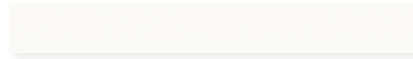

Gallery white pulido / satinado listelo
7,3 x 59,55 cm - 2.87" x 23.45"
G-5111 / 5097

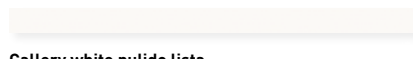

Gallery white pulido lista
3,3 x 59,55 cm - 1.38" x 23.45"
G-5100



Gallery white satinado rodapié 30
7,3 x 29,75 cm - 2.87" x 11.71"
G-5081

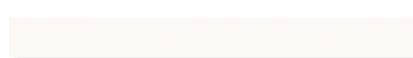

Gallery white pulido / satinado rodapié 60
7,3 x 59,55 cm - 2.87" x 23.45"
G-5125 / 5119

STEPS. GRADINI.PELDAÑOS

SIMPLE		pulido satinado	
		5345	5291
	peldaño simple-30 (30x60 cm)	5345	5291
	peldaño simple-60 (30x60 cm)	5345	5291
	peldaño simple áng. (30x60 cm)	5375	5319
	peldaño simple-60 (60x60 cm)	5501	5501
	peldaño simple áng. (60x60 cm)	5515	5515

GRADONE		pulido satinado	
		5623	5603
	peldaño grad-30 (30x60 cm)	5623	5603
	peldaño grad-60 (30x60 cm)	5623	5603
	peldaño grad. áng. (30x60 cm)	5691	5667
	peldaño grad-60 (60x60 cm)	5609	5609
	peldaño simple áng. (60x60 cm)	5655	5655

* INFO pag 207

COMPLEMENTS.COMPLEMENTI. COMPLEMENTOS



Byte ice / yellow / red / black lista 60*
1,5 x 59,55 cm - 0.59" x 23.45"
G-5100



Pod white / ice / yellow / orange / red / purple / blue / black lista 60*
1,5 x 59,55 cm - 0.59" x 23.45"
G-5100

Fusion natural lista 60*
1 x 59,55 cm - 0.39" x 23.45"
G-5049

Fusion graffiato lista 60
1,5 x 59,55 cm - 0.59" x 23.45"
G-5069

* recommended only for walls



Gallery White - Black Satinado Hexagonal 59,55x51,57 cm

GALLERY yellow

PLAIN TILES.BASE.BASES

SPECIAL PIECES.PEZZI SPECIALI.PIEZAS ESPECIALES



Gallery yellow pulido / satinado
29,75 x 59,55 cm - 11.71" x 23.45"
G-6456 / 6364

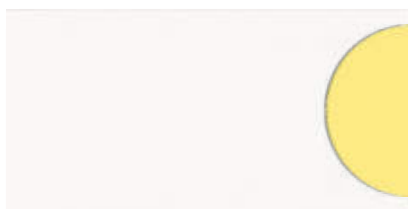

Gallery white satinado b-insert*
29,75 x 59,55 cm - 11.71" x 23.45"
G-5283

Gallery yellow satinado inserto*
R 12,8 cm - R 5"
G-5149

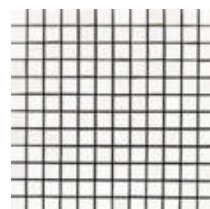

Gallery white satinado mosaico 2,5x2,5
29,75 x 29,75 cm - 11.71" x 11.71"
G-6868



Gallery yellow pulido / satinado taco
7,3 x 7,3 cm - 2.87" x 2.87"
G-5027 / 5025



Gallery yellow pulido listelo-30
7,3 x 29,75 cm - 2.87" x 11.71"
G-5075



Gallery yellow pulido preincisión 2,5x60
29,75 x 59,55 cm - 11.71" x 23.45"
G-6666



Gallery black satinado b-insert*
29,75 x 59,55 cm - 11.71" x 23.45"
G-5283

Gallery yellow satinado inserto*
R 12,8 cm - R 5"
G-5149

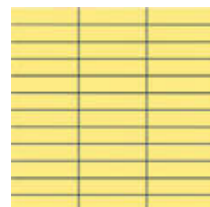

Gallery yellow pulido mosaico 2,5x10
29,75 x 29,75 cm - 11.71" x 11.71"
G-6868

Gallery yellow pulido lista
3,3 x 59,55 cm - 1.38" x 23.45"
G-5100

Gallery yellow satinado rodapié 30
7,3 x 29,75 cm - 2.87" x 11.71"
G-5081

Gallery yellow satinado rodapié 60
7,3 x 59,55 cm - 2.87" x 23.45"
G-5119

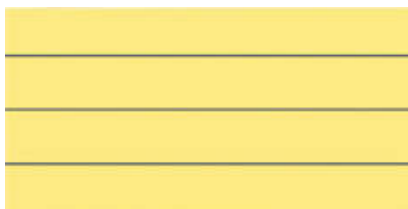

Gallery yellow pulido preincisión 7,5x60
29,75 x 59,55 cm - 11.71" x 23.45"
G-6666

* insert and b-insert are sold separately.
insert y b-insert se venden por separado.

STEPS.GRADINI.PELDAÑOS

SIMPLE	pulido		satinado	
	simple-30	(30x60 cm)	5345	5291
	simple-60	(30x60 cm)	5345	5291
	simple áng.	(30x60 cm)	5375	5319

GRADONE	pulido		satinado	
	grad-30	(30x60 cm)	5623	5603
	grad-60	(30x60 cm)	5623	5603
	grad. áng	(30x60 cm)	5691	5647

* INFO pag. 207.

Gallery satinado

CLASE 1

UNE - ENV 12633

DCOF>0.42

ANSI A 137.1 - 2012



GUARDERIA ALOVERA
Guadalajara. (SPAIN)
Arch. LAUREANO RODRIGUEZ LARGACHA

GALLERY orange

PLAIN TILES.BASE.BASES

SPECIAL PIECES.PEZZI SPECIALI.PIEZAS ESPECIALES



Gallery orange pulido / satinado
29,75 x 59,55 cm - 11.71" x 23.45"
G-6644 / 6594

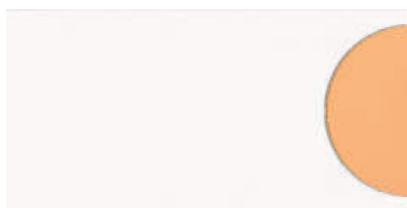

Gallery white satinado b-insert*
29,75 x 59,55 cm - 11.71" x 23.45"
G-5283

Gallery orange satinado inserto*
R 12,8 cm - R 5"
G-5243

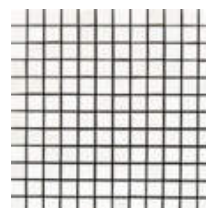

Gallery white satinado mosaico 2,5x2,5
29,75 x 29,75 cm - 11.71" x 11.71"
G-6868



Gallery orange pulido / satinado taco
7,3 x 7,3 cm - 2.87" x 2.87"
G-5047 / 5043



Gallery orange pulido listelo-30
7,3 x 29,75 cm - 2.87" x 11.71"
G-5097



Gallery orange pulido / satinado listelo
7,3 x 59,55 cm - 2.87" x 23.45"
G-5155 / 5141

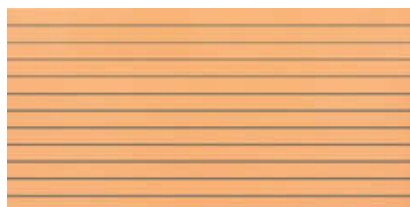

Gallery orange pulido preincisión 2,5x60
29,75 x 59,55 cm - 11.71" x 23.45"
G-6796



Gallery black satinado b-insert*
29,75 x 59,55 cm - 11.71" x 23.45"
G-5283

Gallery orange satinado inserto*
R 12,8 cm - R 5"
G-5243

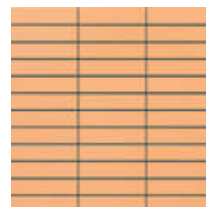

Gallery orange pulido mosaico 2,5x10
29,75 x 29,75 cm - 11.71" x 11.71"
G-6980



Gallery orange pulido lista
3,3 x 59,55 cm - 1.38" x 23.45"
G-5100



Gallery orange satinado rodapié 30
7,3 x 29,75 cm - 2.87" x 11.71"
G-5105



Gallery orange satinado rodapié 60
7,3 x 59,55 cm - 2.87" x 23.45"
G-5165



Gallery orange pulido preincisión 7,5x60
29,75 x 59,55 cm - 11.71" x 23.45"
G-6796

* insert and b-insert are sold separately.
insert y b-insert se venden por separado.

STEPS.GRADINI.PELDAÑOS

SIMPLE	pulido		satinado	
	simple-30 (30x60 cm)	5471	5449	
	simple-60 (30x60 cm)	5471	5449	
	simple áng. (30x60 cm)	5513	5485	

GRADONE	pulido		satinado	
	grad-30 (30x60 cm)	5655	5639	
	grad-60 (30x60 cm)	5655 <td>5639 <td></td> </td>	5639 <td></td>	
	grad. áng (30x60 cm)	5713	5701	

* INFO pag. 207

Gallery satinado

CLASE 1
UNE - ENV 12633

COMPLEMENTS.COMPLEMENTI
COMPLEMENTOS



Byte ice / yellow / red / black lista 60*
1,5 x 59,55 cm - 0.59" x 23.45"
G-5100



Pod white / ice / yellow / orange / red / purple / blue / black lista 60*
1,5 x 59,55 cm - 0.59" x 23.45"
G-5100



Fusion natural lista 60*
1 x 59,55 cm - 0.39" x 23.45"
G-5049



Fusion graffiato lista 60
1,5 x 59,55 cm - 0.59" x 23.45"
G-5069

* recommended only for walls

GALLERY

GALLERY lime

PLAIN TILES.BASE.BASES



Gallery lime pulido / satinado
29,75 x 59,55 cm - 11.71" x 23.45"
G-6656 / 6364



Gallery lime righe
29,75 x 59,55 cm - 11.71" x 23.45"
G-6604

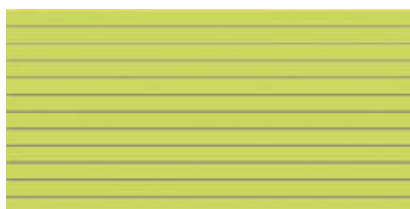

Gallery lime pulido preincisión 2,5x60
29,75 x 59,55 cm - 11.71" x 23.45"
G-6666



Gallery lime pulido preincisión 7,5x60
29,75 x 59,55 cm - 11.71" x 23.45"
G-6666

SPECIAL PIECES.PEZZI SPECIALI.PIEZAS ESPECIALES

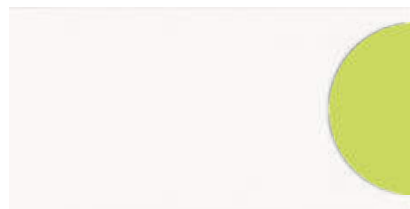

Gallery white satinado b-insert*
29,75 x 59,55 cm - 11.71" x 23.45"
G-5283



Gallery lime satinado inserto*
R 12,8 cm - R 5"
G-5149

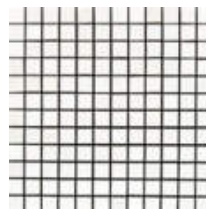

Gallery white satinado mosaico 2,5x2,5
29,75 x 29,75 cm - 11.71" x 11.71"
G-6868



Gallery black satinado b-insert*
29,75 x 59,55 cm - 11.71" x 23.45"
G-5283



Gallery lime satinado inserto*
R 12,8 cm - R 5"
G-5149

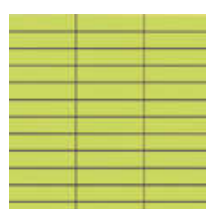

Gallery lime pulido mosaico 2,5x10
29,75 x 29,75 cm - 11.71" x 11.71"
G-6868

* insert and b-insert are sold separately.
insert y b-insert se venden por separado.

STEPS.GRADINI.PELDAÑOS

SIMPLE	pulido satinado	
	peldaño simple-30 (30x60 cm)	5345
peldaño simple-60 (30x60 cm)	5345	5291
peldaño simple áng. (30x60 cm)	5375	5319

GRADONE	pulido satinado	
	peldaño grad-30 (30x60 cm)	5623
peldaño grad-60 (30x60 cm)	5623	5603
peldaño grad. áng (30x60 cm)	5691	5667

+ INFO pag. 207.



Gallery lime pulido / satinado taco
7,3 x 7,3 cm - 2.87" x 2.87"
G-5027 / 5025



Gallery lime pulido listelo-30
7,3 x 29,75 cm - 2.87" x 11.71"
G-5079



Gallery lime pulido / satinado listelo
7,3 x 59,55 cm - 2.87" x 23.45"
G-5111 / 5097



Gallery lime pulido lista
3,3 x 59,55 cm - 1.38" x 23.45"
G-5100



Gallery lime satinado rodapié 30
7,3 x 29,75 cm - 2.87" x 11.71"
G-5081



Gallery lime satinado rodapié 60
7,3 x 59,55 cm - 2.87" x 23.45"
G-5119

COMPLEMENTS.COMPLEMENTI.COMPLEMENTOS



Byte ice / yellow / red / black lista 60*
1,5 x 59,55 cm - 0.59" x 23.45"
G-5100



Pod white / ice / yellow / orange / red / purple / blue / black lista 60*
1,5 x 59,55 cm - 0.59" x 23.45"
G-5100



Fusion natural lista 60*
1 x 59,55 cm - 0.39" x 23.45"
G-5049



Fusion graffiato lista 60
1,5 x 59,55 cm - 0.59" x 23.45"
G-5069

* recommended only for walls

Gallery satinado

CLASE 1
UNE - ENV 12633

DCOF>0.42
ANSI A 137.1 - 2012



GALLERY

Gallery Lime Pulido 29,75x59,55 cm

CARREFOUR SHOPPING CENTER
L'Altet - Alicante. (SPAIN)

GALLERY red

PLAIN TILES.BASE.BASES

SPECIAL PIECES.PEZZI SPECIALI.PIEZAS ESPECIALES



Gallery red pulido / satinado
29,75 x 59,55 cm - 11.71" x 23.45"
G-6870 / 6844

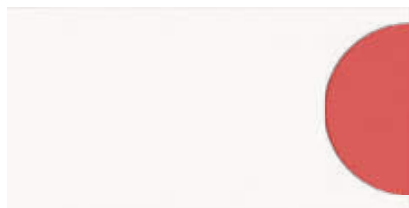

Gallery white satinado b-insert*
29,75 x 59,55 cm - 11.71" x 23.45"
G-5283

Gallery red satinado inserto*
R 12,8 cm - R 5"
G-5367

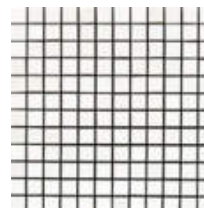

Gallery white satinado mosaico 2,5x2,5
29,75 x 29,75 cm - 11.71" x 11.71"
G-6868



Gallery red pulido / satinado taco
7,3 x 7,3 cm - 2.87" x 2.87"
G-5059 / 5061



Gallery red pulido / satinado listelo
7,3 x 59,55 cm - 2.87" x 23.45"
G-5251 / 5243



Gallery red pulido lista
3,3 x 59,55 cm - 1.38" x 23.45"
G-5100



Gallery red satinado rodapié 30
7,3 x 29,75 cm - 2.87" x 11.71"
G-5163



Gallery red satinado rodapié 60
7,3 x 59,55 cm - 2.87" x 23.45"
G-5283



Gallery red pulido preincisión 2,5x60
29,75 x 59,55 cm - 11.71" x 23.45"
G-6987



Gallery black satinado b-insert*
29,75 x 59,55 cm - 11.71" x 23.45"
G-5283

Gallery red satinado inserto*
R 12,8 cm - R 5"
G-5367

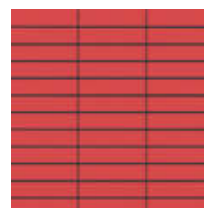

Gallery red pulido mosaico 2,5x10
29,75 x 29,75 cm - 11.71" x 11.71"
G-6996

* insert and b-insert are sold separately.
insert y b-insert se venden por separado.



Gallery red pulido preincisión 7,5x60
29,75 x 59,55 cm - 11.71" x 23.45"
G-6987

STEPS.GRADINI.PELDAÑOS

SIMPLE	pulido satinado			
	peleñaño simple-30 (30x60 cm)	5693	5681	
	peleñaño simple-60 (30x60 cm)	5693	5681	
	peleñaño simple áng. (30x60 cm)	5701	5687	

GRADONE	pulido satinado			
	peleñaño grad-30 (30x60 cm)	5755	5749	
	peleñaño grad-60 (30x60 cm) <th>5755</th> <th>5749</th> <td></td>	5755	5749	
	peleñaño grad. áng (30x60 cm) <th>5829</th> <th>5815</th> <td></td>	5829	5815	

* INFO pag. 207.

Gallery satinado

CLASE 1

UNE - ENV 12633

DCOF>0.42

ANSI A 137.1 - 2012



ELEMENTARY SCHOOL SEIXAL
Seixal. (PORTUGAL)
Arch. JOSÉ JESUITA

GALLERY blue

PLAIN TILES.BASE.BASES

SPECIAL PIECES.PEZZI SPECIALI.PIEZAS ESPECIALES



Gallery blue pulido / satinado
29,75 x 59,55 cm - 11.71" x 23.45"
G-6558 / 6506

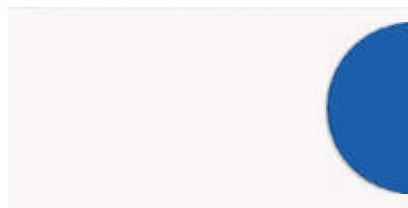

Gallery white satinado b-insert*
29,75 x 59,55 cm - 11.71" x 23.45"
G-5283

Gallery blue satinado inserto*
R 12,8 cm - R 5"
G-5149

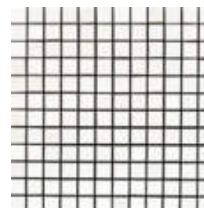

Gallery white satinado mosaico 2,5x2,5
29,75 x 29,75 cm - 11.71" x 11.71"
G-6868



Gallery blue pulido / satinado taco
7,3 x 7,3 cm - 2.87" x 2.87"
G-5041 / 5039



Gallery blue pulido / satinado listelo
7,3 x 59,55 cm - 2.87" x 23.45"
G-5135 / 5131



Gallery blue pulido lista
3,3 x 59,55 cm - 1.38" x 23.45"
G-5100



Gallery blue satinado rodapié 30
7,3 x 29,75 cm - 2.87" x 11.71"
G-5089



Gallery blue satinado rodapié 60
7,3 x 59,55 cm - 2.87" x 23.45"
G-5141



Gallery blue pulido preincisión 2,5x60
29,75 x 59,55 cm - 11.71" x 23.45"
G-6790



Gallery black satinado b-insert*
29,75 x 59,55 cm - 11.71" x 23.45"
G-5283

Gallery blue satinado inserto*
R 12,8 cm - R 5"
G-5149

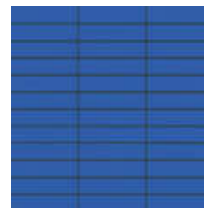

Gallery blue pulido mosaico 2,5x10
29,75 x 29,75 cm - 11.71" x 11.71"
G-6960

* insert and b-insert are sold separately.
insert y b-insert se venden por separado.

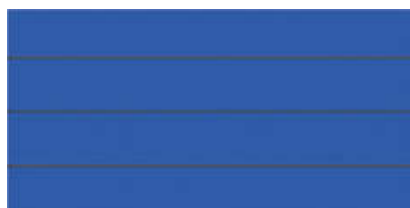

Gallery blue pulido preincisión 7,5x60
29,75 x 59,55 cm - 11.71" x 23.45"
G-6790

STEPS.GRADINI.PELDAÑOS

SIMPLE		pulido satinado	
		30x60 cm	30x60 cm
	peldaño simple-30	5445	5401
	peldaño simple-60	5445	5401
	peldaño simple áng.	5445	5431

GRADONE		pulido satinado	
		30x60 cm	30x60 cm
	peldaño grad-30	5623	5603
	peldaño grad-60	5623	5603
	peldaño grad. áng.	5691	5667

* INFO pag. 207

Gallery satinado

CLASE 1

UNE - ENV 12633

DCOF>0.42

ANSI A 137.1 - 2012

COMPLEMENTS.COMPLEMENTI.
COMPLEMENTOS



Byte ice / yellow / red / black lista 60*
1,5 x 59,55 cm - 0.59" x 23.45"
G-5100



Pod white / ice / yellow / orange / red / purple / blue / black lista 60*
1,5 x 59,55 cm - 0.59" x 23.45"
G-5100



Fusion natural lista 60*
1 x 59,55 cm - 0.39" x 23.45"
G-5049



Fusion graffiato lista 60
1,5 x 59,55 cm - 0.59" x 23.45"
G-5069

* recommended only for walls

GALLERY

GALLERY black

PLAIN TILES.BASE.BASES

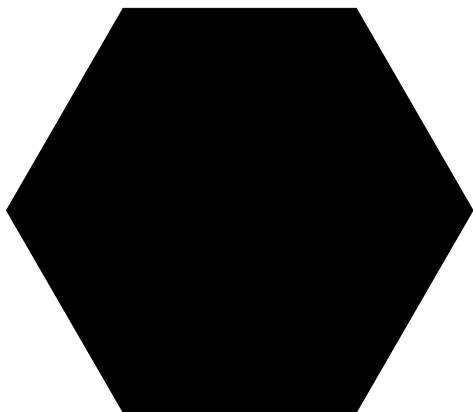

Gallery black satinado hexagonal

59,55 x 51,57 cm - 23.45" x 20.31"

G-6558

3 mm joint are recommended for hexagonal sizes.
para formatos hexagonales se recomienda una junta de separación de 3 mm.

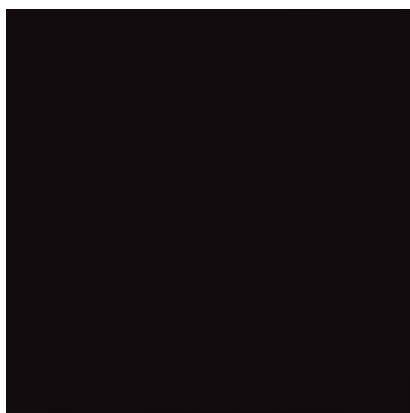

Gallery black pulido / satinado

59,55 x 59,55 cm - 23.45" x 23.45"

G-6506 / 6452

Gallery satinado

CLASE 1

UNE - ENV 12633

DCOF>0.42

ANSI A 137.1 - 2012



Gallery black pulido / satinado

29,75 x 59,55 cm - 11.71" x 23.45"

G-6450 / 6352



Gallery black righe

29,75 x 59,55 cm - 11.71" x 23.45"

G-6392

SPECIAL PIECES.PEZZI SPECIALI.PIEZAS ESPECIALES



Gallery black pulido preincisión 2,5x60

29,75 x 59,55 cm - 11.71" x 23.45"

G-6666

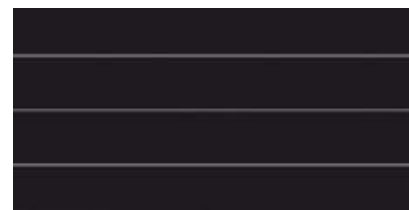

Gallery black pulido preincisión 7,5x60

29,75 x 59,55 cm - 11.71" x 23.45"

G-6666

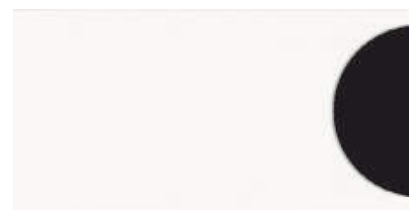

Gallery white satinado b-insert*

29,75 x 59,55 cm - 11.71" x 23.45"

G-5283

Gallery black satinado inserto*

R 12,8 cm - R 5"

G-5149



Gallery black satinado b-insert*

29,75 x 59,55 cm - 11.71" x 23.45"

G-5283

Gallery white satinado inserto*

R 12,8 cm - R 5"

G-5149

* insert and b-insert are sold separately. /
insert y b-insert se venden por separado.

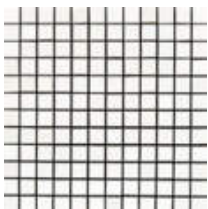

**Gallery white satinado
mosaico 2,5x2,5**
29,75 x 29,75 cm - 11.71" x 11.71"
G-6868

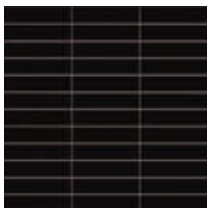

**Gallery black pulido
mosaico 2,5x10**
29,75 x 29,75 cm - 11.71" x 11.71"
G-6858



**Gallery black
pulido / satinado taco**
7,3 x 7,3 cm - 2.87" x 2.87"
G-5027 / 5025



Gallery black pulido / satinado listelo
7,3 x 59,55 cm - 2.87" x 23.45"
G-5109 / 5095



Gallery black pulido lista
3,3 x 59,55 cm - 1.38" x 23.45"
G-5100



Gallery black satinado rodapié 30
7,3 x 29,75 cm - 2.87" x 11.71"
G-5081



Gallery black pulido / satinado rodapié 60
7,3 x 59,55 cm - 2.87" x 23.45"
G-5125 / 5117

STEPS. GRADINI.PELDAÑOS

SIMPLE			pulido satinado	
	peldaño simple-30	(30x60 cm)	5337	5281
	peldaño simple-60	(30x60 cm)	5337	5281
	peldaño simple áng.	(30x60 cm)	5367	5367
	peldaño simple-60	(60x60 cm)	5501	5501
	peldaño simple áng.	(60x60 cm)	5515	5515

GRADONE			pulido satinado	
	peldaño grad-30	(30x60 cm)	5623	5603
	peldaño grad-60	(30x60 cm)	5623	5603
	peldaño grad. áng.	(30x60 cm)	5691	5667
	peldaño grad-60	(60x60 cm)	5609	5609
	peldaño simple áng.	(60x60 cm)	5655	5655

* INFO pag 207

COMPLEMENTS.COMPLEMENTI. COMPLEMENTOS



Byte ice / yellow / red / black lista 60*
1,5 x 59,55 cm - 0.59" x 23.45"
G-5100



**Pod white / ice / yellow / orange / red /
purple / blue / black lista 60***
1,5 x 59,55 cm - 0.59" x 23.45"
G-5100

Fusion natural lista 60*
1 x 59,55 cm - 0.39" x 23.45"
G-5049

Fusion graffiato lista 60
1,5 x 59,55 cm - 0.59" x 23.45"
G-5069



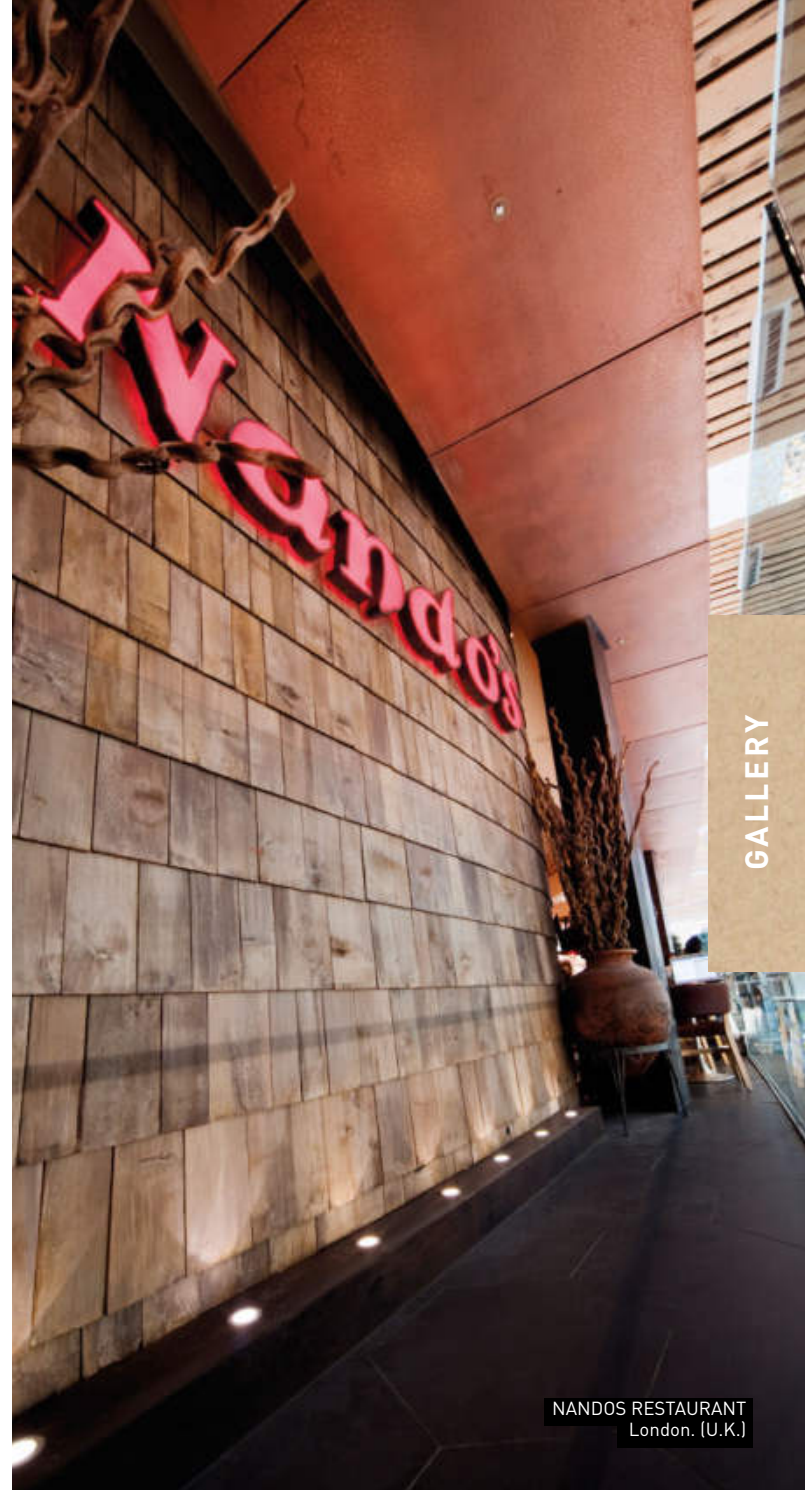











* recommended only for walls



GALLERY

NANDOS RESTAURANT
London. (U.K.)

TECHNICAL CHARACTERISTICS. CARATTERISTICHE TECNICHE. CARACTERÍSTICAS TÉCNICAS

MEASUREMENTS AND SURFACES APPEARANCE / DIMENSIONI E ASPETTO SUPERFICIALE / MEDIDAS Y ASPECTO SUPERFICIAL / MASSEN UND AUSSEHEN DER OBERFLÄCHE		STANDARD TEST METHOD METODO DELLA NORMA METODO DE ENSAYO STANDARD TEST METHOD	STANDARD PRESCRIBED VALUES VALORE PRESCRITTO VALORES STANDARD NORMA STANDARDWERTE	GALLERY collection *
 Length and width. <i>Lunghezza e larghezza.</i> Longitud y anchura. Länge und Breite		ISO 10545-2	± 0,6% max.	± 0,1%
 Thickness. <i>Spessore.</i> Grosor. Stärke		ISO 10545-2	± 5% max.	± 2%
 90° Orthogonality. <i>Ortogonalità.</i> Ortogonalidad. Rechtwinkligkeit		ISO 10545-2	± 0,6% max.	± 0,2%
 Straightness of sides. <i>Rettilinearità dei lati.</i> Rectitud de lados. Kantengeradigkeit		ISO 10545-2	± 0,5% max.	± 0,2%
 Surfaces flatness. <i>Planarità.</i> Planitud. Ebenföchigkeit		ISO 10545-2	± 0,5% max.	± 0,2%
PHYSICAL PROPERTIES / PROPIETÀ FISICHE / PROPIEADADES FÍSICAS / PHYSIKALISCHE EIGENSCHAFTEN				
 Water absorption. <i>Assorbimento d'acqua.</i> Absorción de agua. Wasseraufnahme		ISO 10545-3	≤ 0,5%	0,1%
 Breaking strength, in N. <i>Carico di rottura, en N.</i> Carga de rotura, en N. Bruchlast, in N	thickness > 7,5 mm spessore > 7,5 mm grosor > 7,5 mm	ISO 10545-4	≥ 1300 N	2200 N *
 Modulus of rupture. <i>Resistenza alla flessione.</i> Resistencia a la flexión. Biegefestigkeit		ISO 10545-4	≥ 35 N/mm ²	52 N/mm ² *
 Resistance to deep abrasion. <i>Resistenza all'abrasione profonda.</i> Resistencia a la abrasión profunda. Tiefverschleissbeständigkeit		ISO 10545-6	≤ 175 mm ³	121 mm ³ ***
 Resistance to thermal shock. <i>Resistenza agli sbalzi termici.</i> Resistencia al choque térmico. Temperaturwechselbeständigkeit		ISO 10545-9	No surface defects should be visible Non deve presentare difetti visibili No debe presentar defectos superficiales visibles	Resistant. Resistente. Resistente
 Frost resistance. <i>Resistenza al gelo.</i> Resistencia a la helada. Frostbeständigkeit		ISO 10545-12	No surface defects or cracks should be visible Non deve presentare difetti visibili No debe presentar defectos ni grietas superficiales visibles	Frost Resistant Antighiaccio Resistente a la Helada
 Coefficient of friction. <i>Resistenza allo scivolamento.</i> Coeficiente de fricción. Rutschfestigkeit		UNE - ENV 12633 ASTM C 1028-96	WET TEST/ENSAYO EN HÚMEDO DRY TEST/ENSAYO EN SECO S.C.O.F. > 0.60 (for horizontal surfaces)	Clase I ** Clase 3 *** SCOF: 0.70 - 0.79 **** DCOF - ANSIA 137.1-2012 > 0.42
 Colour resistance to light. <i>Resistenza dei colori alla luce.</i> Resistencia del color a la luz. Lichtbeständigkeit der Farben		DIN 51094	There should be no colour variations Non deve presentare sbalzi visibili No debe presentar variaciones de color	No alterations to colour and shine Non deve presentare alterazioni di colori e lucentezza No debe presentar variaciones de color y brillo
CHEMICAL PROPERTIES / PROPIETÀ CHIMICHE / PROPIEADADES QUÍMICAS / CHEMISCHEN EIGENSCHAFTEN				
 Chemical resistance. <i>Resistenza agli agenti chimici.</i> Resistencia química. Chemikalienbeständigkeit		ISO 10545-13	Resistance to household cleaning products and swimmingpools salts. Resistencia a productos domésticos y sales para piscinas	Min. UB
 Resistance to staining. <i>Resistenza alle macchie.</i> Resistencia a las manchas. Fleckenbeständigkeit		ISO 10545-14	≥ 3	4 *** - 5

* The Land values are the average of different production consignments. For further detail information, please check with our commercial network. / I valori dichiarati sono ottenuti da una media di prove effettuate su diverse produzioni. Per avere informazioni dettagliate consultare la rete commerciale / Los valores declarados son el promedio obtenido a través de ensayos de diferentes producciones. Para la obtención de una información detallada consultar a la red comercial.

** Tested in satinado finishes. Test realized in internal laboratory. Provere realizzato in laboratorio interno. Ensayo realizado en laboratorio interno. Gallery hexagonal white satinado (clase I).

*** Test realized in Gallery white pulido. Provere realizzato in Gallery white pulido. Ensayo realizado en Gallery white pulido. (lote 4-11-05)

**** Dry Test, according to document DA DB-SUA/3 (Código Técnico de la Edificación) M° de Fomento. Average test result value, on May 2012. Ensayo realizado, según documento DA DB-SUA/3 (Código Técnico de la Edificación) M° de Fomento, valor medio a fecha Mayo 2012.

***** SMITH-EMERY laboratories. SCOF: Static Coefficient of Friction. Tested in satinado: 0.66 (wet) , 0.86 (dry). (lote 03-11-06)



GALLERY

Gallery Lime - Orange - Blue - Red - Yellow Satinado 29,75x59,55 cm
Pietra Serena Moss Natural 29,75x59,55 cm

CASA JUVENTUD DE AUTOL
Logroño. (SPAIN)
Arch. MD. ARQUITECTURA-URBANISMO, S.L.
Juan Carlos Merino Álvarez

GALLERY SLIM



COLOURS



VIENNA INTERNATIONAL SCHOOL
Vienna. (AUSTRIA)



* Gallery slim white. Content of recycled material. Contenido de material reciclado.

FORMATS.FORMATI.FORMATOS



30X60
29,75x59,55 cm - 11.71"x23.45"



30X90 natural
29,75x89,46 cm - 11.71"x35.22"



30X90 hexagon
29,75x89,46 cm - 11.71"x35.22"

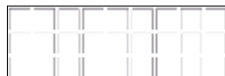

30X90 square
29,75x89,46 cm - 11.71"x35.22"

SPECIAL PIECES.PEZZI SPECIALI.PIEZAS ESPECIALES



30X30 mosaico 2,5x2,5
29,75x29,75 cm - 11.71"x11.71"



30X30 mosaico multicolor 2,5x2,5
29,75x29,75 cm - 11.71"x11.71"



30X30 mosaico 10x10
29,75x29,75 cm - 11.71"x11.71"

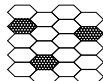

30X30 mosaico hexagonal 6x7,5
29,75x29,75 cm - 11.71"x11.71"

THICKNESS.SPESSORE.ESPEORES

 0,48 cm approx. / 0.19" approx.

COLOURS COLORI COLORES



white



orange



lime



red



blue



black

FINISHES FINITURI ACABADOS



natural

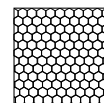

hexagon

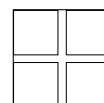

square

GALLERY SLIM white

PLAIN TILES.BASE.BASES

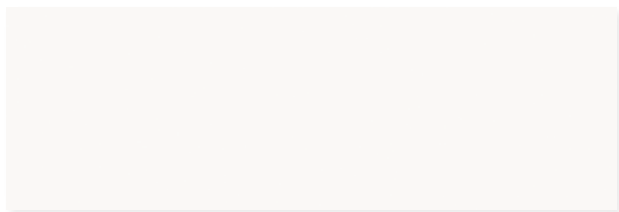

Gallery slim white natural
29,75 x 89,46 cm - 11.71" x 35.22"
G-6224

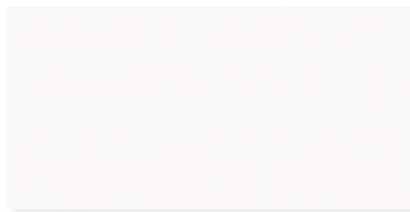

Gallery slim white
29,75 x 59,55 cm - 11.71" x 23.45"
G-6218

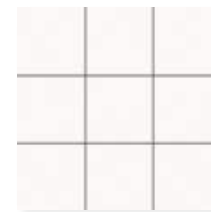

**Gallery slim white
mosaico 10x10**
29,75 x 29,75 cm - 11.71" x 11.71"
G-6666



Gallery slim white square
29,75 x 89,46 cm - 11.71" x 35.22"
G-6246

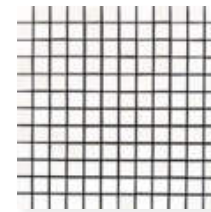

**Gallery slim white
mosaico 2,5x2,5**
29,75 x 29,75 cm - 11.71" x 11.71"
G-6756

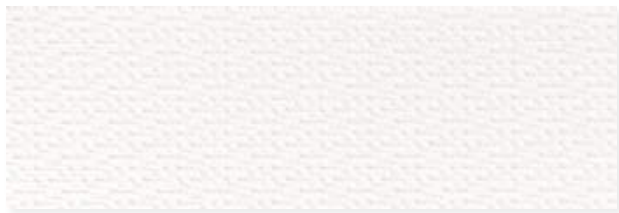

Gallery slim white hexagon
29,75 x 89,46 cm - 11.71" x 35.22"
G-6246



**Gallery slim white
mosaico hexagonal 6x7,5***
29,75 x 29,75 cm - 11.71" x 11.71"
G-6796

COMPLEMENTS.COMPLEMENTI.COMPLEMENTOS

Fusion graffiato lista 90
1,5 x 89,46 cm - 0.59" x 35.22"



G-5091

Fusion graffiato lista 60
1,5 x 59,55 cm - 0.59" x 23.45"



G-5069

Fusion natural lista 60
1 x 59,55 cm - 0.39" x 23.45"



G-5049

* the three hexagonal tesserae change pattern randomly.
las tres teselas hexagon cambian de posición aleatoriamente.



GALLERY SLIM

Gallery Slim White Hexagon 29,75x89,46 cm

GALLERY SLIM black

PLAIN TILES.BASE.BASES



Gallery slim black natural
29,75 x 89,46 cm - 11.71" x 35.22"
G-6224



Gallery slim black
29,75 x 59,55 cm - 11.71" x 23.45"
G-6240

SPECIAL PIECES.PEZZI SPECIALI.
PIEZAS ESPECIALES



**Gallery slim black
mosaico 10x10**
29,75 x 29,75 cm - 11.71" x 11.71"
G-6666



Gallery slim black square
29,75 x 89,46 cm - 11.71" x 35.22"
G-6246

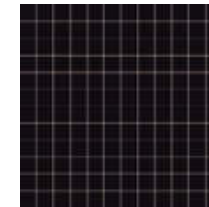

**Gallery slim black
mosaico 2,5x2,5**
29,75 x 29,75 cm - 11.71" x 11.71"
G-6756



Gallery slim black hexagon
29,75 x 89,46 cm - 11.71" x 35.22"
G-6246



**Gallery slim black
mosaico hexagonal 6x7,5***
29,75 x 29,75 cm - 11.71" x 11.71"
G-6796

COMPLEMENTS.COMPLEMENTI.COMPLEMENTOS

Fusion graffiato lista 90
1,5 x 89,46 cm - 0.59" x 35.22"



Fusion graffiato lista 60
1,5 x 59,55 cm - 0.59" x 23.45"



Fusion natural lista 60
1 x 59,55 cm - 0.39" x 23.45"



* the three hexagonal tesserae change pattern randomly.
las tres teselas hexagon cambian de posición aleatoriamente.



GALLERY SLIM

wall: Gallery Slim White Square_Black Natural 29,75x89,46 cm floor: Gallery White - Black Satinado 59,55x59,55 cm

GALLERY SLIM lime - orange - red - blue

PLAIN TILES.BASE.BASES

SPECIAL PIECES.PEZZI SPECIALI.
PIEZAS ESPECIALES



Gallery slim lime
29,75 x 59,55 cm - 11.71" x 23.45"
G-6218

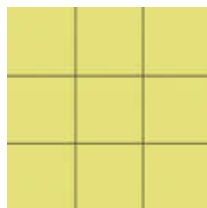

**Gallery slim lime
mosaico 10x10**
29,75 x 29,75 cm - 11.71" x 11.71"
G-6666

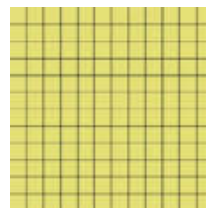

**Gallery slim lime
mosaico 2,5x2,5**
29,75 x 29,75 cm - 11.71" x 11.71"
G-6756



Gallery slim orange
29,75 x 59,55 cm - 11.71" x 23.45"
G-6240

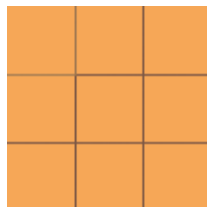

**Gallery slim orange
mosaico 10x10**
29,75 x 29,75 cm - 11.71" x 11.71"
G-6666

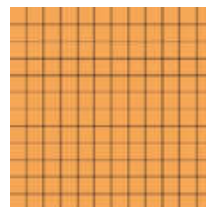

**Gallery slim orange
mosaico 2,5x2,5**
29,75 x 29,75 cm - 11.71" x 11.71"
G-6756



Gallery slim red
29,75 x 59,55 cm - 11.71" x 23.45"
G-6240

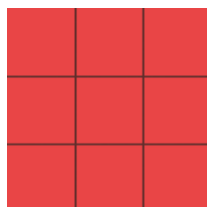

**Gallery slim red
mosaico 10x10**
29,75 x 29,75 cm - 11.71" x 11.71"
G-6666

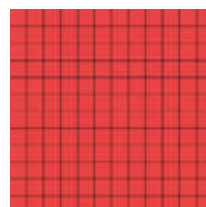

**Gallery slim red
mosaico 2,5x2,5**
29,75 x 29,75 cm - 11.71" x 11.71"
G-6756

COMPLEMENTS.COMPLEMENTI.
COMPLEMENTOS

Fusion graffiato lista 60
1,5 x 59,55 cm - 0.59" x 23.45"



G-5069

Fusion natural lista 60
1 x 59,55 cm - 0.39" x 23.45"



G-5049

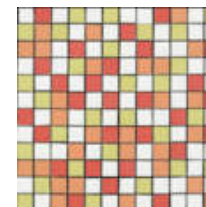

**Gallery slim red
mosaico multicolor 2,5x2,5**
29,75 x 29,75 cm - 11.71" x 11.71"
G-6756



Gallery slim blue
29,75 x 59,55 cm - 11.71" x 23.45"
G-6240

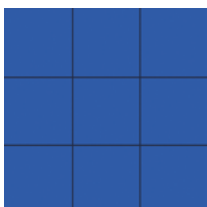

**Gallery slim blue
mosaico 10x10**
29,75 x 29,75 cm - 11.71" x 11.71"
G-6666



**Gallery slim blue
mosaico 2,5x2,5**
29,75 x 29,75 cm - 11.71" x 11.71"
G-6756

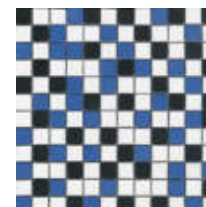













**Gallery slim blue
mosaico multicolor 2,5x2,5**
29,75 x 29,75 cm - 11.71" x 11.71"
G-6756



GALLERY SLIM

Gallery Slim Lime - White - Black 29,75x59,55 cm

TECHNICAL CHARACTERISTICS. CARATTERISTICHE TECNICHE. CARACTERÍSTICAS TÉCNICAS

MEASUREMENTS AND SURFACES APPEARANCE / DIMENSIONI E ASPETTO SUPERFICIALE / MEDIDAS Y ASPECTO SUPERFICIAL / MASSES UND AUSSEHEN DER OBERFLÄCHE		STANDARD TEST METHOD METODO DELLA NORMA METODO DE ENSAYO STANDARD TEST METHOD	STANDARD PRESCRIBED VALUES VALORE PRESCRITTO VALORES STANDARD NORMA STANDARDWERTE	Gallery Slim *
 Length and width. <i>Lunghezza e larghezza.</i> Longitud y anchura. Länge und Breite		ISO 10545-2	± 0,6% max.	± 0,1%
 Orthogonality. <i>Ortogonalità.</i> Ortogonalidad. Rechtwinkligkeit		ISO 10545-2	± 0,6% max.	± 0,2%
 Straightness of sides. <i>Rettilinearità dei lati.</i> Rectitud de lados. Kantengeradigkeit		ISO 10545-2	± 0,5% max.	± 0,2%
 Surfaces flatness. <i>Planarità.</i> Planitud. Ebenföchigkeit		ISO 10545-2	± 0,5% max.	± 0,2%
PHYSICAL PROPERTIES / PROPIETÀ FISICHE / PROPIEDADES FÍSICAS / PHYSIKALISCHE EIGENSCHAFTEN				
 Water absorption. <i>Assorbimento d'acqua.</i> Absorción de agua. Wasseraufnahme		ISO 10545-3	≤ 0,5%	< 0,1%
 Breaking strength, in N. <i>Carico di rottura, en N.</i> Carga de rotura, en N. Bruchlast, in N	thickness>7,5 mm spessore>7,5 mm grösor>7,5 mm	ISO 10545-4	≥ 700 N	Available Method * Metodo Disponibile Metodo Disponible
 Modulus of rupture. <i>Resistenza alla flessione.</i> Resistencia a la flexión. Biegefestigkeit		ISO 10545-4	≥ 35 N/mm ²	>40 N/mm ² *
 Resistance to thermal shock. <i>Resistenza agli sbalzi termici.</i> Resistencia al choque térmico. Temperaturwechselbeständigkeit		ISO 10545-9	No surface defects should be visible Non deve presentare difetti visibili No debe presentar defectos superficiales visibles	Resistant. Resistente. Resistente
 Crazing resistance. <i>Resistenza agli fessurazione.</i> Resistencia al cuarteo. Ribbeständigkeit		ISO 10545-11	No surface defects or cracks should be visible Non deve presentare difetti visibili No debe presentar defectos ni grietas superficiales visibles	Resistant. Resistente. Resistente
 Frost resistance. <i>Resistenza al gelo.</i> Resistencia a la helada. Frostbeständigkeit		ISO 10545-12	No surface defects or cracks should be visible Non deve presentare difetti visibili No debe presentar defectos ni grietas superficiales visibles	Frost Resistant Antighiaccio Resistente a la Helada
 Coefficient of friction. <i>Resistenza allo scivolamento.</i> Coeficiente de fricción. Rutschfestigkeit		DIN 51130		Available Method Metodo Disponibile Metodo Disponible
 Colour resistance to light. <i>Resistenza dei colori alla luce.</i> Resistencia del color a la luz. Lichtbeständigkeit der Farben		DIN 51094	There should be no colour variations Non deve presentare difetti visibili No debe presentar variaciones de color	No alterations to colour and shine Non deve presentare alterazioni di colori e lucentezza No debe presentar variaciones de color y brillo
CHEMICAL PROPERTIES / PROPIETÀ CHIMICHE / PROPIEDADES QUÍMICAS / CHEMISCHEN EIGENSCHAFTEN				
 Chemical resistance. <i>Resistenza agli agenti chimici.</i> Resistencia química. Chemikalienbeständigkeit		ISO 10545-13	Resistance to household cleaning products and swimmingpools salts. Resistencia a productos domésticos y sales para piscinas	Min. GB
 Resistance to staining. <i>Resistenza alle macchie.</i> Resistencia a las manchas. Fleckenbeständigkeit		ISO 10545-14	≥ 3	5 *

*The Land values are the average of different production consignments. For further detail information, please check with our commercial network. /
I valori dichiarati sono ottenuti da una media di prove effettuate su diverse produzioni. Per avere informazioni dettagliate consultare la rete commerciale /
Los valores declarados son el promedio obtenido a través de ensayos de diferentes producciones. Para la obtención de una información detallada consultar a la red comercial.

ADVANTAGES. VANTAGGI. VENTAJAS

- Time. *Tempo.* Tiempo
- Money. *Denaro.* Dinero
- Hygiene. *Igiene.* Higiene
- Ecologic. *Ecologia.* Ecología
- Technology. *Tecnologia.* Tecnología

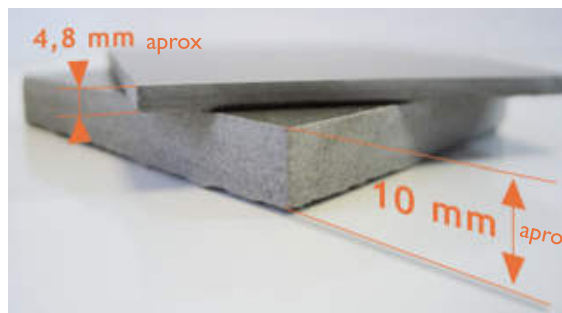

* Recommended only for wall. /
solo recomendado como revestimiento.



Gallery Slim White 29,75x59,55 cm

MEDITERRÁNEO HOTEL
Roses, Girona. (SPAIN)
Int. Design. LAIA RISQUES

GALLERY SLIM

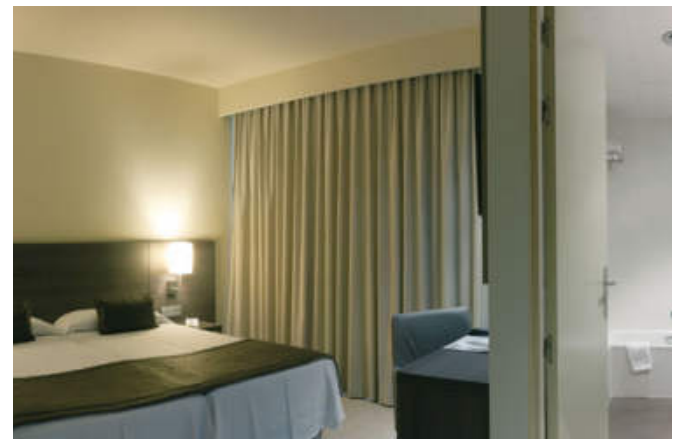

GALLERY WALL



COLOURS



PRIMARY SCHOOL.
Castellón. (SPAIN)
Arch. NACHO CARBÓ / RAFAEL CULLA



PRIMARY SCHOOL.
Jaén. (SPAIN)
Arch. JAVIER RUEDA MENA

* Gallery wall brillo. Content of recycled material. Contenido de material reciclado.

FORMATS.FORMATI.FORMATOS



30X90
29,75x89,46 cm - 11.71"x35.22"



30X60
29,75x59,55 cm - 11.71"x23.45"



15X90
14,70x89,46 cm - 5.79"x35.22"

SPECIAL PIECES.PEZZI SPECIALI.PIEZAS ESPECIALES



30X90 rigato
29,75x89,46 cm - 11.71"x35.22"



1,5X60 corner
1,5x59,55 cm - 0.59"x23.45"



1,5X30 corner
1,5x29,75 cm - 0.59"x11.71"

* Recommended only for wall. /
sólo recomendado como revestimiento.

THICKNESS.SPESSORE.ESPESORES

≡ 1,14 cm / 0.45" approx.
≡ 1,03 cm / 0.40" approx.

30x90 cm / 15x90 cm FORMATS
30x60 cm FORMAT

COLOURS
COLORI
COLORES



white



orange



lime



red



blue



black

FINISHES
FINITURI
ACABADOS



mate



brillo

GALLERY WALL **white***

PLAIN TILES. BASE. BASES

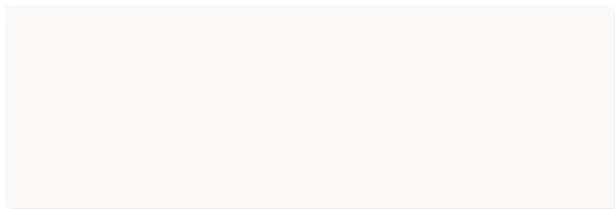

Gallery wall white brillo / mate
29,75 x 89,46 cm - 11.71" x 35.22"
G-6240 / 6240

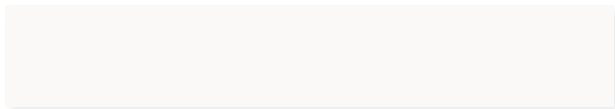

Gallery wall white brillo / mate
14,70 x 89,46 cm - 5.79" x 35.22"
G-6284 / 6284

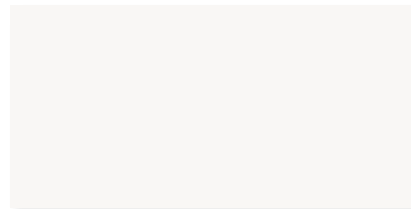

Gallery wall white brillo
29,75 x 59,55 cm - 11.71" x 23.45"
G-6208



Gallery white brillo / mate corner 60
1,5 x 59,55 cm - 0.59" x 23.45"
G-5155 / 5155

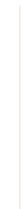

Gallery white brillo / mate corner 30
1,5 x 29,75 cm - 0.59" x 11.71"
G-5085 / 5085

SPECIAL PIECES. PEZZI SPECIALI. PIEZAS ESPECIALES



Gallery wall white rigato mate
29,75 x 89,46 cm - 11.71" x 35.22"
G-6284



Byte white / ice / yellow / orange / red / purple / blue / grey / moss / black lista 90
2 x 89,46 cm - 0.79" x 35.22"
G-5173



Fusion graffiato lista 90
1,5 x 89,46 cm - 0.59" x 35.22"
G-5091



Byte ice / yellow / red / black lista 60
1,5 x 59,55 cm - 0.59" x 23.45"
G-5100



Fusion natural lista 60
1 x 59,55 cm - 0.39" x 23.45"
G-5049



Fusion graffiato lista 60
1,5 x 59,55 cm - 0.59" x 23.45"
G-5069



Pod white / ice / yellow / orange / red / purple / blue / black lista 60
1,5 x 59,55 cm - 0.59" x 23.45"
G-5100

FLOOR TILES. PAVIMENTO. PAVIMENTO

FORMATS. FORMATI. FORMATOS

30 x 60 cm

COLOURS. COLORI. COLORES



FINISHES. FINITURE. ACABADOS

putido
satinado
rigue

See floor tiles collection on page 170.
Ver colección completa de pavimento
en página 170.

* Recommended only for wall. /
sólo recomendado como revestimiento.

GALLERY WALL lime*

PLAIN TILES.BASE.BASES

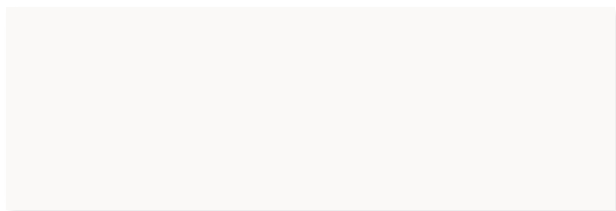

Gallery wall white brillo / mate
29,75 x 89,46 cm - 11.71" x 35.22"
G-6240 / 6240



Gallery wall lime mate
29,75 x 89,46 cm - 11.71" x 35.22"
G-6258



Gallery wall lime mate
14,70 x 89,46 cm - 5.79" x 35.22"
G-6300

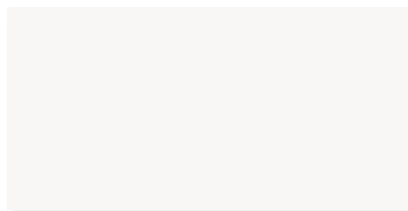

Gallery wall white brillo
29,75 x 59,55 cm - 11.71" x 23.45"
G-6208 / 6208



Gallery wall lime brillo
29,75 x 59,55 cm - 11.71" x 23.45"
G-6240



Gallery lime brillo corner 60
1,5 x 59,55 cm - 0.59" x 23.45"
G-5155



Gallery white brillo / mate corner 30
1,5 x 29,75 cm - 0.59" x 11.71"
G-5085 / 5085



Gallery lime brillo / mate corner 30
1,5 x 29,75 cm - 0.59" x 11.71"
G-5085 / 5085

SPECIAL PIECES.PEZZI SPECIALI.PIEZAS ESPECIALES



Gallery wall lime rigato mate
29,75 x 89,46 cm - 11.71" x 35.22"
G-6300



Byte yellow lista 90
2 x 89,46 cm - 0.79" x 35.22"
G-5173



Fusion graffiato lista 90
1,5 x 89,46 cm - 0.59" x 35.22"
G-5091



Pod yellow lista 60
1,5 x 59,55 cm - 0.59" x 23.45"
G-5100



Fusion natural lista 60
1 x 59,55 cm - 0.39" x 23.45"
G-5049



Fusion graffiato lista 60
1,5 x 59,55 cm - 0.59" x 23.45"
G-5069



Byte ice / yellow / red / black lista 60
1,5 x 59,55 cm - 0.59" x 23.45"
G-5100



Steel corner
1 x 250 cm - 0.39" x 98.42"
G-5503



Steel corner
1 x 250 cm - 0.39" x 98.42"
G-5503

GALLERY WALL

FLOOR TILES. PAVIMENTO.PAVIMENTO

FORMATS.FORMATI.FORMATOS

30 x 60 cm

COLOURS.COLORI.COLORES



FINISHES.FINITURE.ACABADOS

pulido

satinado

rigue

See floor tiles collection on page 170.
Ver colección completa de pavimento
en página 170.

GALLERY WALL red*

PLAIN TILES.BASE.BASES

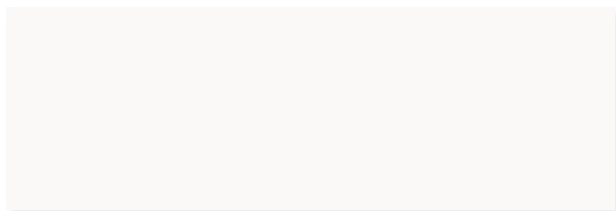

Gallery wall white brillo / mate
29,75 x 89,46 cm - 11.71" x 35.22"
G-6240 / 6240



Gallery wall red mate
29,75 x 89,46 cm - 11.71" x 35.22"
G-6270



Gallery wall red mate
14,70 x 89,46 cm - 5.79" x 35.22"
G-6312

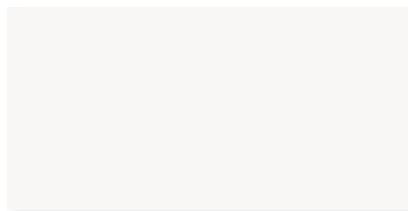

Gallery wall white brillo
29,75 x 59,55 cm - 11.71" x 23.45"
G-6208 / 6208



Gallery wall red brillo
29,75 x 59,55 cm - 11.71" x 23.45"
G-6254



Gallery red brillo corner 60
1,5 x 59,55 cm - 0.59" x 23.45"
G-5155



Gallery white brillo / mate corner 30
1,5 x 29,75 cm - 0.59" x 11.71"
G-5085 / 5085



Gallery red brillo / mate corner 30
1,5 x 29,75 cm - 0.59" x 11.71"
G-5085 / 5085

SPECIAL PIECES.PEZZI SPECIALI.PIEZAS ESPECIALES



Pod red lista 60
1,5 x 59,55 cm - 0.59" x 23.45"
G-5100

Fusion natural lista 60
1 x 59,55 cm - 0.39" x 23.45"
G-5049

Fusion graffiato lista 60
1,5 x 59,55 cm - 0.59" x 23.45"
G-5069

Gallery wall red rigato mate
22,21 x 89,46 cm - 8.75" x 35.22"
G-6312



Byte red lista 90
2 x 89,46 cm - 0.79" x 35.22"
G-5173



Fusion graffiato lista 90
1,5 x 89,46 cm - 0.59" x 35.22"
G-5091

* Recommended only for wall. /
solo recomendado como revestimiento.



Byte ice / yellow / red / black lista 60
1,5 x 59,55 cm - 0.59" x 23.45"
G-5100



Steel corner
1 x 250 cm - 0.39" x 98.42"
G-5503

FLOOR TILES. PAVIMENTO.PAVIMENTO

FORMATS.FORMATI.FORMATOS

30 x 60 cm

COLOURS.COLORI.COLORES



FINISHES.FINITURE.ACABADOS

pulido
satinado
rigue

See floor tiles collection on page 170.
Ver colección completa de pavimento
en página 170.



GALLERY WALL

GALLERY WALL orange*

PLAIN TILES.BASE.BASES

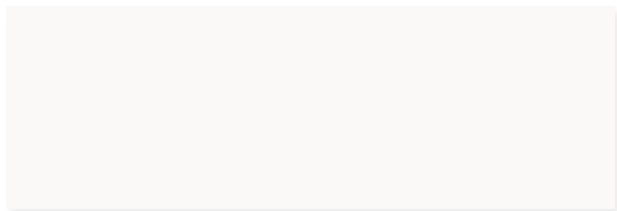

Gallery wall white brillo / mate

29,75 x 89,46 cm - 11.71" x 35.22"
G-6240 / 6240



Gallery wall orange mate

29,75 x 89,46 cm - 11.71" x 35.22"
G-6258



Gallery wall orange mate

14,70 x 89,46 cm - 5.79" x 35.22"
G-6300



Gallery wall orange rigato mate

29,75 x 89,46 cm - 11.71" x 35.22"
G-6300



Byte orange lista 90

2 x 89,46 cm - 0.79" x 35.22"
G-5173



Fusion graffiato lista 90

1,5 x 89,46 cm - 0.59" x 35.22"
G-5091

* Recommended only for wall. /
sólo recomendado como revestimiento.

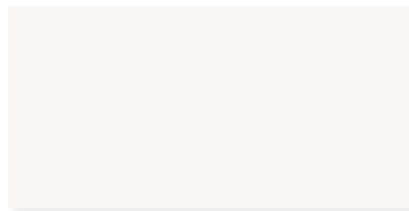

Gallery wall white brillo

29,75 x 59,55 cm - 11.71" x 23.45"
G-6208 / 6208



Gallery wall orange brillo

29,75 x 59,55 cm - 11.71" x 23.45"
G-6240



Gallery orange brillo corner 60

1,5 x 59,55 cm - 0.59" x 23.45"
G-5155



Gallery white brillo / mate corner 30

1,5 x 29,75 cm - 0.59" x 11.71"
G-5085 / 5085



Gallery orange brillo / mate corner 30

1,5 x 29,75 cm - 0.59" x 11.71"
G-5085 / 5085



Pod orange lista 60

1,5 x 59,55 cm - 0.59" x 23.45"
G-5100

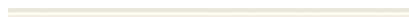

Fusion natural lista 60

1 x 59,55 cm - 0.39" x 23.45"
G-5049



Fusion graffiato lista 60

1,5 x 59,55 cm - 0.59" x 23.45"
G-5069



Byte ice / yellow / red / black lista 60

1,5 x 59,55 cm - 0.59" x 23.45"
G-5100



Steel corner

1 x 250 cm - 0.39" x 98.42"
G-5503

10.8 cm
1.2 cm

FLOOR TILES. PAVIMENTO.PAVIMENTO

FORMATS.FORMATI.FORMATOS

30 x 60 cm

COLOURS.COLORI.COLORES



FINISHES.FINITURE.ACABADOS

pulido
satinado
rigue

See floor tiles collection on page 170.
Ver colección completa de pavimento
en página 170.

GALLERY WALL **black***

PLAIN TILES.BASE.BASES

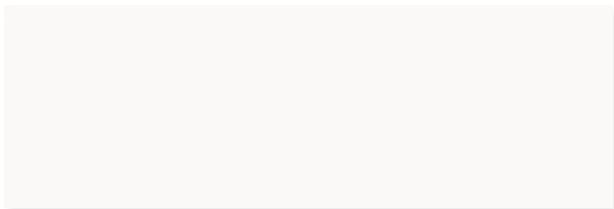

Gallery wall white brillo / mate
29,75 x 89,46 cm - 11.71" x 35.22"
G-6240 / 6240



Gallery wall black mate
29,75 x 89,46 cm - 11.71" x 35.22"
G-6258



Gallery wall black mate
14,70 x 89,46 cm - 5.79" x 35.22"
G-6300

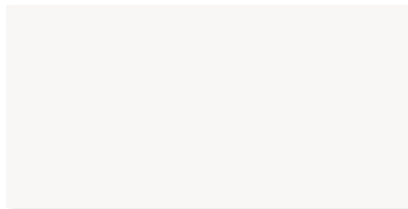

Gallery wall white brillo
29,75 x 59,55 cm - 11.71" x 23.45"
G-6208 / 6208



Gallery wall black brillo
29,75 x 59,55 cm - 11.71" x 23.45"
G-6240



Gallery black brillo corner 60
1,5 x 59,55 cm - 0.59" x 23.45"
G-5155



Gallery white brillo / mate corner 30
1,5 x 29,75 cm - 0.59" x 11.71"
G-5085 / 5085



Gallery black brillo / mate corner 30
1,5 x 29,75 cm - 0.59" x 11.71"
G-5085 / 5085

SPECIAL PIECES.PEZZI SPECIALI.PIEZAS ESPECIALES



Gallery wall black rigato mate
29,75 x 89,46 cm - 11.71" x 35.22"
G-6300



Byte black lista 90
2 x 89,46 cm - 0.79" x 35.22"
G-5173



Fusion graffiato lista 90
1,5 x 89,46 cm - 0.59" x 35.22"
G-5091

* Recommended only for wall. /
sólo recomendado como revestimiento.



Pod black lista 60
1,5 x 59,55 cm - 0.59" x 23.45"
G-5100

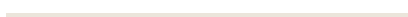

Fusion natural lista 60
1 x 59,55 cm - 0.39" x 23.45"
G-5049



Fusion graffiato lista 60
1,5 x 59,55 cm - 0.59" x 23.45"
G-5069



Byte ice / yellow / red / black lista 60
1,5 x 59,55 cm - 0.59" x 23.45"
G-5100



Steel corner
1 x 250 cm - 0.39" x 98.42"
G-5503

GALLERY WALL

FLOOR TILES. PAVIMENTO.PAVIMENTO

FORMATS.FORMATI.FORMATOS

30 x 60 cm

COLOURS.COLORI.COLORES



FINISHES.FINITURE.ACABADOS

pulido
satinado
rigue

See floor tiles collection on page 170.
Ver colección completa de pavimento
en página 170.

GALLERY WALL **blue***

PLAIN TILES.BASE.BASES

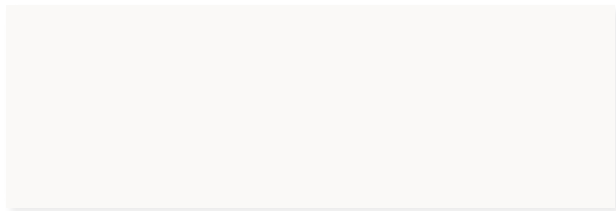

Gallery wall white brillo / mate
29,75 x 89,46 cm - 11.71" x 35.22"
G-6240 / 6240



Gallery wall blue mate
29,75 x 89,46 cm - 11.71" x 35.22"
G-6270



Gallery wall blue mate
14,70 x 89,46 cm - 5.79" x 35.22"
G-6312

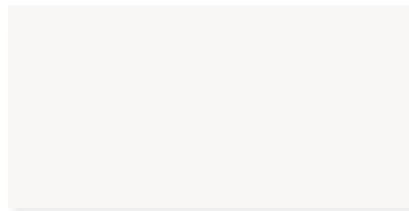

Gallery wall white brillo
29,75 x 59,55 cm - 11.71" x 23.45"
G-6208 / 6208



Gallery wall blue brillo
29,75 x 59,55 cm - 11.71" x 23.45"
G-6254



Gallery blue brillo corner 60
1,5 x 59,55 cm - 0.59" x 23.45"
G-5155



Gallery white brillo / mate corner 30
1,5 x 29,75 cm - 0.59" x 11.71"
G-5085 / 5085



Gallery blue brillo / mate corner 30
1,5 x 29,75 cm - 0.59" x 11.71"
G-5085 / 5085

SPECIAL PIECES.PEZZI SPECIALI.PIEZAS ESPECIALES



Gallery wall blue rigato mate
29,75 x 89,46 cm - 11.71" x 35.22"
G-6312



Byte blue lista 90
2 x 89,46 cm - 0.79" x 35.22"
G-5173



Fusion graffiato lista 90
1,5 x 89,46 cm - 0.59" x 35.22"
G-5091



Pod blue lista 60
1,5 x 59,55 cm - 0.59" x 23.45"
G-5100

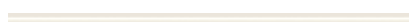

Fusion natural lista 60
1 x 59,55 cm - 0.39" x 23.45"
G-5049



Fusion graffiato lista 60
1,5 x 59,55 cm - 0.59" x 23.45"
G-5069



Byte ice / yellow / red / black lista 60
1,5 x 59,55 cm - 0.59" x 23.45"
G-5100



Steel corner
1 x 250 cm - 0.39" x 98.42"
G-5503

FLOOR TILES. PAVIMENTO.PAVIMENTO

FORMATS.FORMATI.FORMATOS

30 x 60 cm

COLOURS.COLORI.COLORES



FINISHES.FINITURE.ACABADOS

putido
satinado
rigue

See floor tiles collection on page 170.
Ver colección completa de pavimento en página 170.

* Recommended only for wall. /
sólo recomendado como revestimiento.



PULSADOR
78

3

GALLERY WALL

PRIMARY SCHOOL
Castellón. (SPAIN)
Arch. NACHO CARBÓ / RAFAEL CULLA

ISMO

WOOD

PLAIN TILES. BASE. BASES



Ismo moka natural / lappato

59,55 x 59,55 cm - 23.45" x 23.45"

G-6386 marfil natural / G-6426 marfil lappato
G-6372 beige natural / G-6410 beige lappato
G-6372 moka natural / G-6410 moka lappato
G-6372 antracita natural



Ismo moka natural / lappato

29,75 x 59,55 cm - 11.71" x 23.45"

G-6314 marfil lappato
G-6298 beige lappato
G-6258 moka natural / G-6298 moka lappato
G-6258 antracita natural

COLOURS
COLORI
COLORES



Marfil



Beige

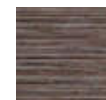

Moka



Antracita

SPECIAL PIECES. PEZZI SPECIALI. PIEZAS ESPECIALES



Ismo mosaico lappato 2,5x2,5

29,75x29,75 cm - 11.71"x11.71"

G-6756 marfil lappato
G-6756 beige lappato
G-6756 moka lappato
G-6756 antracita lappato



Ismo multicolor lappato mosaico 2,5x2,5

29,75x29,75 cm - 11.71"x11.71"

G-6756 marfil lappato
G-6756 beige lappato
G-6756 moka lappato
G-6756 antr. lappato



Ismo lappato módulo 30X60

29,75x59,55 cm - 11.71"x23.45"

G-5311 marfil lappato
G-5311 beige lappato
G-5311 moka lappato



Ismo natural / lappato listelo

2,3x59,55 cm - 0.91"x23.45"

G-5083 marfil natural / G-5083 marfil lappato
G-5083 beige natural / G-5083 beige lappato
G-5083 moka natural / G-5083 moka lappato
G-5083 antracita natural



Ismo mosaico lappato 2,5x30

29,75x29,75 cm - 11.71"x11.71"

G-6756 marfil lappato
G-6756 beige lappato
G-6756 moka lappato
G-6756 antracita lappato



30X30 multicolor lappato mosaico 1,5x30

29,75x29,75 cm - 11.71"x11.71"

G-6756 marfil lappato
G-6756 beige lappato
G-6756 moka lappato
G-6756 antr. lappato



Ismo natural rodapié-60

7,2x59,55 cm - 2.83"x23.45"

G-5097 marfil natural
G-5097 beige natural
G-5097 moka natural
G-5097 antracita natural

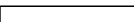

Ismo natural / lappato lista

7,2x59,55 cm - 2.83"x23.45"

G-5087 marfil natural / G-5091 marfil lappato
G-5087 beige natural / G-5091 beige lappato
G-5087 moka natural / G-5091 moka lappato
G-5087 antracita natural

Natural / Lappato

CLASE 1

UNE - ENV 12633



ISMO

Ismo Moka Natural 59,55x59,55 cm

OLIVIER RESTAURANT
Lisboa, (PORTUGAL)
Arch. Sofia COSTA



ORIGIN

STONE

PLAIN TILES.BASE.BASES



Origin gris lappato

44,63 x 44,63 cm - 17.57" x 17.57"

G-6300 marfil lappato

G-6258 crema natural / G-6286 crema lappato

G-6258 gris lappato

G-6258 savanna lappato

G-6234 antracita natural

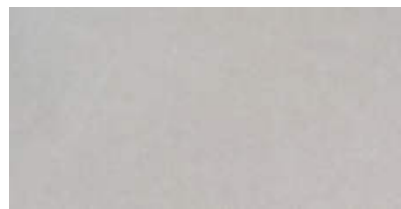

Origin gris natural

29,75 x 59,55 cm - 11.71" x 23.45"

G-6234 gris natural

G-6234 savanna natural / G-6258 savanna lappato

COLOURS
COLORI
COLORES



Marfil



Crema



Gris



Savanna

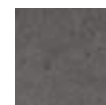

Antracita



Origin natural cenefa-1

9,60x59,55 cm - 3.78"x23.45"

G-5087 savanna natural

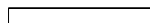

Origin listelo 60

7,2x59,55 cm - 2.83"x23.45"

G-5085 gris natural

G-5085 savanna natural

G-5087 savanna lappato

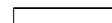

Origin listelo 45

7,2x59,55 cm - 2.83"x23.45"

G-5083 marfil natural

G-5081 crema natural

G-5071 crema lappato

G-5067 savanna lappato



Origin listelo 30

7,2x59,55 cm - 2.83"x23.45"

G-5054 gris natural

G-5053 savanna natural

G-5055 savanna lappato

SPECIAL PIECES. PEZZI SPECIALI.PIEZAS ESPECIALES



Origin mosaico lappato 2,5x2,5

29,75x29,75 cm - 11.71"x11.71"

G-6780 marfil lappato

G-6756 crema lappato

G-6756 gris lappato

G-6756 savanna lappato



Origin mosaico lappato 2,5x10

29,75x29,75 cm - 11.71"x11.71"

G-6708 marfil lappato

G-6688 crema lappato

G-6688 gris lappato

G-6688 savanna lappato



Origin lappato corte

29,75x29,75 cm - 11.71"x11.71"

G-5161 crema lappato

G-5161 savanna lappato



Origin lappato listelo sin fin

29,75x29,75 cm - 11.71"x11.71"

G-5155 marfil lappato

G-5155 crema lappato

G-5155 savanna lappato



Origin preincisión 2,5x60

29,75x59,55 cm - 11.71"x23.45"

G-6486 savanna lappato



Origin natural rodapié-60

7,2x59,55 cm - 2.83"x23.45"

G-5095 gris natural

G-5095 savanna natural



Origin natural rodapié-45

7,2x59,55 cm - 2.83"x23.45"

G-5083 marfil natural

G-5081 crema natural



Origin natural rodapié-30

7,2x59,55 cm - 2.83"x23.45"

G-5056 gris natural

G-5065 savanna natural

Natural / Lappato

CLASE 1

UNE - ENV 12633



Origin Gris Lappato 29,75x59,55 cm

BLANCO & NEGRO OPTICIAN'S
Elda, Alicante. (SPAIN)

ORIGIN

DAGON

STONE

PLAIN TILES.BASE.BASES



Micerino marfil natural / lappato
29,75 x 59,55 cm - 11.71" x 23.45"
G-6258 / 6298



Micerino beige natural
29,75 x 59,55 cm - 11.71" x 23.45"
G-6258



Micerino siena natural
29,75 x 59,55 cm - 11.71" x 23.45"
G-6234



Micerino vison natural
29,75 x 59,55 cm - 11.71" x 23.45"
G-6234 / 6274



Micerino savanna natural / lappato
29,75 x 59,55 cm - 11.71" x 23.45"
G-6258 / 6298

SPECIAL PIECES. PEZZI SPECIALI.PIEZAS ESPECIALES



**Abidos lappato
mosaico 2,5x10**
29,75 x 29,75 cm - 11.71" x 11.71"
G-6688



**Abidos lappato
mosaico 2,5x2,5**
29,75 x 29,75 cm - 11.71" x 11.71"
G-6756



**Abidos lappato
mosaico sin fin**
29,75 x 29,75 cm - 11.71" x 11.71"
G-5155



Abidos natural rodapié 30
7,3 x 29,75 cm - 2.87" x 11.71"
G-5065 siena / vison
G-5067 marfil / beige / savanna

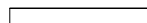

Micerino listelo
7,3 x 59,55 cm - 2.87" x 23.45"
G-5087 savanna nat G-5091 savanna lap
G-5085 vison nat G-5087 marfil nat
G-5091 marfil lap
G-5085 siena nat
G-5087 beige nat



Micerino lappato cenefa-1
9,74 x 59,55 cm - 3.84" x 23.45"
G-5089 savanna
G-5097 marfil



Abidos listelo 30
7,3 x 59,55 cm - 2.87" x 23.45"
G-5055 savanna nat G-5057 savanna lap
G-5053 vison nat G-5053 siena nat
G-5055 siena lap G-5057 marfil lap
G-5055 marfil nat
G-5055 beige nat



Micerino natural rodapié 60
7,3 x 59,55 cm - 2.87" x 23.45"
G-5095 siena / vison
G-5097 marfil / beige / savanna

Natural

CLASE 1

UNE - ENV 12633

JERUSALEM

STONE

PLAIN TILES.BASE.BASES



Jerusalem grey natural
59,55 x 59,55 cm - 23.45" x 23.45"
G-6286



Jerusalem grey natural
29,75 x 59,55 cm - 11.71" x 23.45"
G-6218



Jerusalem visón natural
59,55 x 59,55 cm - 23.45" x 23.45"
G-6286

COMPLEMENTS.COMPLEMENTI.COMPLEMENTOS

Byte white / moss / red / black lista 60*
1,5 x 59,55 cm - 0.59" x 23.45"

G-5100

Fusion natural lista 60*
1 x 59,55 cm - 0.39" x 23.45"

G-5049

Fusion graffiato lista 60
1,5 x 59,55 cm - 0.59" x 23.45"

G-5069

* recommended only for walls

SPECIAL PIECES. PEZZI SPECIALI.PIEZAS ESPECIALES



30X30 mosaico 3D 5x5
29,75x29,75 cm - 11.71"x11.71"



30X30 mosaico 5x5
29,75x29,75 cm - 11.71"x11.71"



7,5X60 rodapié
7,3x59,55 cm - 2.87"x23.45"

STEPS. GRADINI.PELDAÑOS

		natural
SIMPLE	peldaño simple-30 (30x60 cm)	5171
	peldaño simple-60 (30x60 cm)	5171
	peldaño simple áng. (30x60 cm)	5187
	peldaño simple (60x60 cm)	5281
	peldaño simple áng. (60x60 cm)	5299

		natural
GRADONE	peldaño grad-30 (30x60 cm)	5559
	peldaño grad-60 (30x60 cm)	5559
	peldaño grad áng. (30x60 cm)	5609
	peldaño gradone (60x60 cm)	5559
	peldaño grad. áng. (60x60 cm)	5609

* INFO pag. 221

JAMTLAND

STONE

PLAIN TILES.BASE.BASES



Jamtland ivory natural / lappato
59,55 x 59,55 cm - 23.45" x 23.45"
G-6330 / G-6372

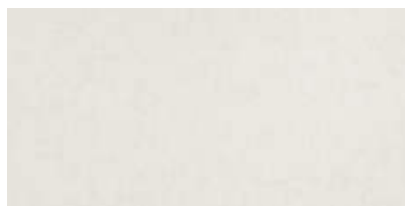

Jamtland ivory natural / lappato
29,75 x 59,55 cm - 11.71" x 23.45"
G-6258 / G-6298



Jamtland ivory natural / lappato listelo
7,3 x 59,55 cm - 2.87" x 23.45"
G-5087 / G-5091



Jamtland graphite natural / lappato
59,55 x 59,55 cm - 23.45" x 23.45"
G-6330 / G-6372



Jamtland graphite natural / lappato
29,75 x 59,55 cm - 11.71" x 23.45"
G-6258 / G-6298



Jamtland graphite natural / lappato listelo
7,3 x 59,55 cm - 2.87" x 23.45"
G-5087 / G-5091

SPECIAL PIECES. PEZZI SPECIALI.PIEZAS ESPECIALES

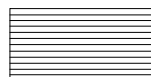

30X60 preincisión 2,5x60
29,75x59,55 cm - 11.71"x23.45"



30X30 mosaico 5x5
29,75x29,75 cm - 11.71"x11.71"

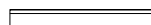

7,5X60 rodapié
7,3x59,55 cm - 2.87"x23.45"

STEPS. GRADINI.PELDAÑOS

SIMPLE			natural	lappato
	peldaño simple-30 (30x60 cm)	5171	5195	
peldaño simple-60 (30x60 cm)	5171	5195		
peldaño simple áng. (30x60 cm)	5187	5211		
peldaño simple (60x60 cm)	5281	5281		
peldaño simple áng. (60x60 cm)	5299	5299		

GRADONE			natural	lappato
	peldaño grad-30 (30x60 cm)	5559	5559	
peldaño grad-60 (30x60 cm)	5559	5559		
peldaño gradone áng. (30x60 cm)	5609	5609		
peldaño gradone (60x60 cm)	5559	5559		
peldaño grad. áng (60x60 cm)	5609	5609		

+ INFO pag 221

COMPLEMENTS. COMPLEMENTI. OTRAS COMPLEMENTOS

GLASS. VETRO. CRISTAL



Byte white / ice / yellow / orange / red / purple / blue / grey / moss / black lista 90 *
2 x 89,46 cm - 0.79" x 35.22"



G-5173



Byte ice / yellow / red / black lista 60 *
1,5 x 59,55 cm - 0.59" x 23.45"



G-5100



Pod white / ice / yellow / orange / red / purple / blue / black lista 60 *
1,5 x 59,55 cm - 0.59" x 23.45"



G-5100

METAL. METALLO. METAL



Fusion graffiato lista 90 **
1,5 x 89,46 cm - 0.59" x 35.22"



G-5091



Fusion graffiato lista 60 **
1,5 x 59,55 cm - 0.59" x 23.45"



G-5069



Fusion lista 60 *
1 x 59,55 cm - 0.39" x 23.45"



G-5049

CORNERS. ANGOLI. ESQUINAS

GALLERY WALL



Gallery white brillo / mate corner 60 *
1,5 x 59,55 cm - 0.59" x 23.45"



G-5155



Gallery lime / orange / red / blue / black brillo corner 60 *
1,5 x 59,55 cm - 0.59" x 23.45"



G-5155



Gallery white / lime / orange / red / blue / black brillo / mate corner 30 *
1,5 x 29,75 cm - 0.59" x 11.71"



G-5085



Steel corner
1 x 250 cm - 0.39" x 98.42"



G-5503

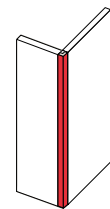
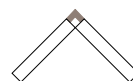

Ceramic corner.
Angoli ceramico.
Esquina cerámica

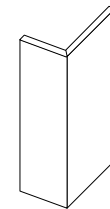

Miter.
Jolly.
Inglete

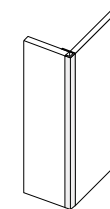
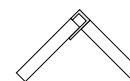

Metallic profile.
Perfil metallico.
Perfil metálico

* recommended only for walls

** recommended for walls and floors

CORNER SOLUTIONS. SOLUZIONE DI ANGOLI. SOLUCIONES DE ESQUINAS.

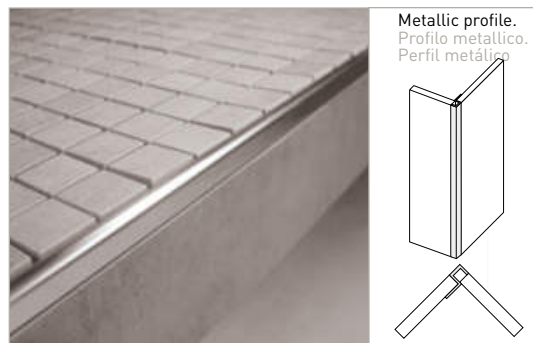
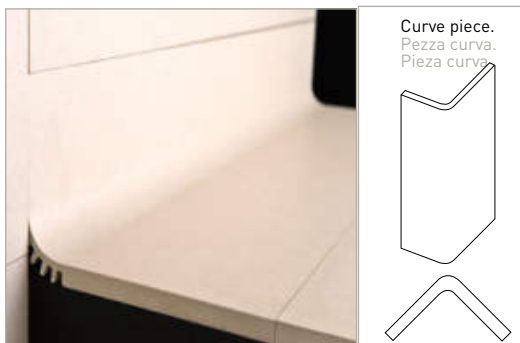
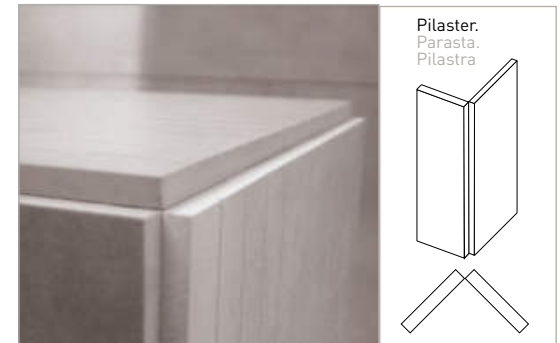
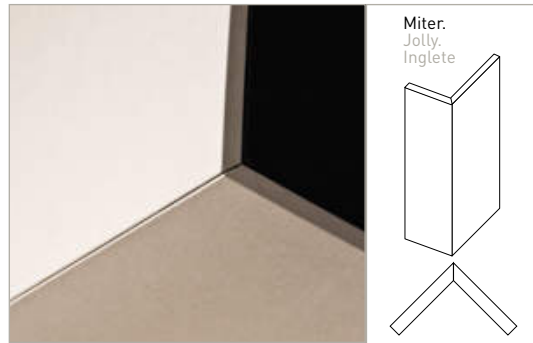
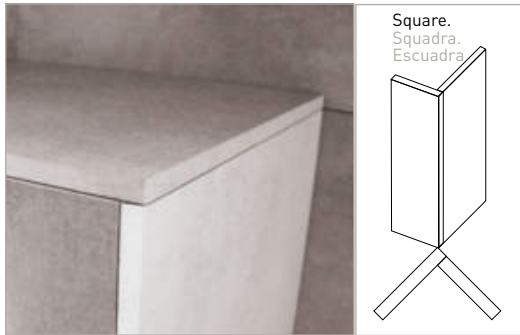

TECHNICAL SOLUTIONS. SOLUZIONI TECNICHE. SOLUCIONES TÉCNICAS.

SPECIAL PIECES. PEZZI SPECIALI. PIEZAS ESPECIALES.

Skirtings. Rodapiés



round edge. canto romo

Borders. Listelos



straight edge. canto recto

Zanquín

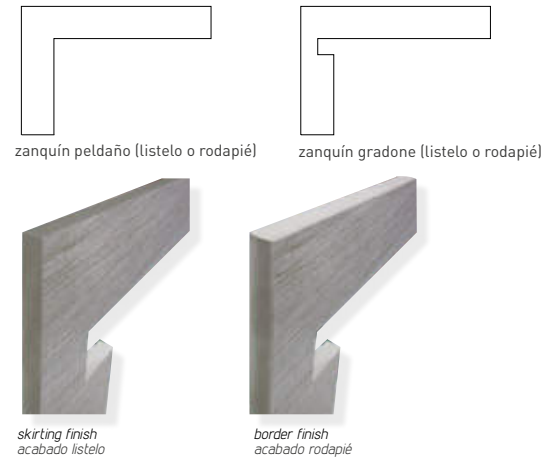

SPECIAL PIECES. PEZZI SPECIALI. PIEZAS ESPECIALES.

STEPS. GRADINI. PELDAÑOS.

Simple



30x120 cm - 45x90 cm - 30x60 cm

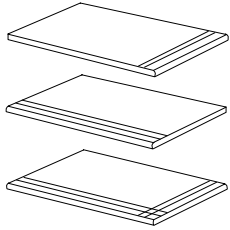

90x90 cm - 60x60 cm - 45x45 cm

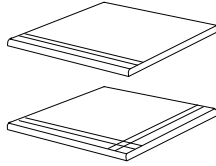

59,55x51,57 Hexagonal

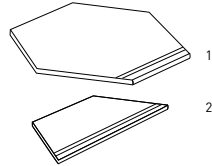

[Commercial formats
Formatos comerciales]

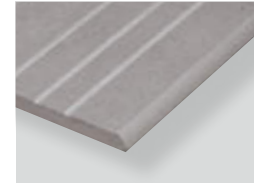

Gradone



30x120 cm - 45x90 cm - 30x60 cm

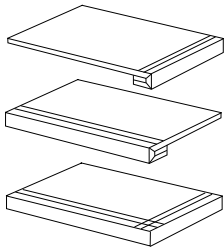

90x90 cm - 60x60 cm - 45x45 cm

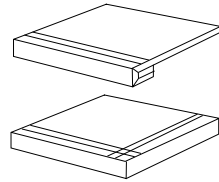

59,55x51,57 Hexagonal

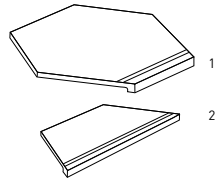

[Commercial formats
Formatos comerciales]

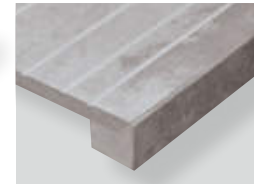

Steps

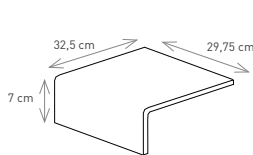

Step 30x60 cm*

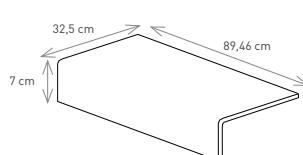

Step 45x90 cm*

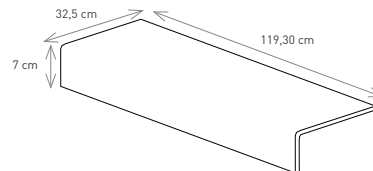

Step 60x120 cm*

Commercial formats
Formatos comerciales



* Upon request. In quantities at least 100 units. Deadline: 60 days. / Artículo sobre pedido. Cantidad mínima: 100 piezas. Plazo de entrega: 60 días.

* For further detail information, please check with our commercial network. / Para la obtención de una información detallada consultar a la red comercial.

All these products are also available without grooves. For availability of steps of each collection and its price groups go to each collection pages.

To purchase steps you should specify the relevant reference needed:

*model name + colour + finish + size + step specific reference + with or without grooves.

Examples: Civic Grey Natural 45x90 Gradone 45 with grooves or Portland Grey Natural 60x60 Peldaño Ángulo without grooves.

Todos estos productos también se pueden realizar sin ranuras bajo indicación expresa. Para conocer la disponibilidad de peldaños de cada colección y sus grupos de precio dirigirse a las páginas específicas de la colección deseada.

Para realizar el pedido de peldaños se debe referenciar de la siguiente manera:

*nombre del modelo + color + acabado + formato + referencia específica del peldaño + sin o con ranuras.

Ejemplos: Civic Grey Natural 45x90 Gradone 45 con ranuras o Portland Grey Natural 60x60 Peldaño Ángulo sin ranuras.

3D CONCEPT

Our 3D Concept collection is the result of a development process that started with the sole purpose of creating a differentiated product that could become the most important decorative element in any project. Our piece UP was the beginning of this exclusive collection and it is now available in a total of six different shapes.

La nostra collezione 3D Concept è il risultato di un processo di sviluppo che è iniziato con l'intenzione di creare un prodotto differenziato che potrebbe diventare l'elemento decorativo più importante in qualsiasi progetto. Il nostro pezzo UP è stato l'inizio di questa esclusiva collezione che ha un totale di sei modelli differenti.

La Colección 3D Concept es el resultado de un proceso de desarrollo que se inició con la única finalidad de crear un producto diferenciado que pudiera convertirse en el elemento decorativo de mayor importancia en cualquier proyecto. Nuestra pieza UP fue el comienzo de esta exclusiva colección que hoy dispone de un total de seis formas diferentes.



3-DIMENSIONAL PIECES. PEZZI TRIDIMENSIONALE. PIEZAS TRIDIMENSIONALES.

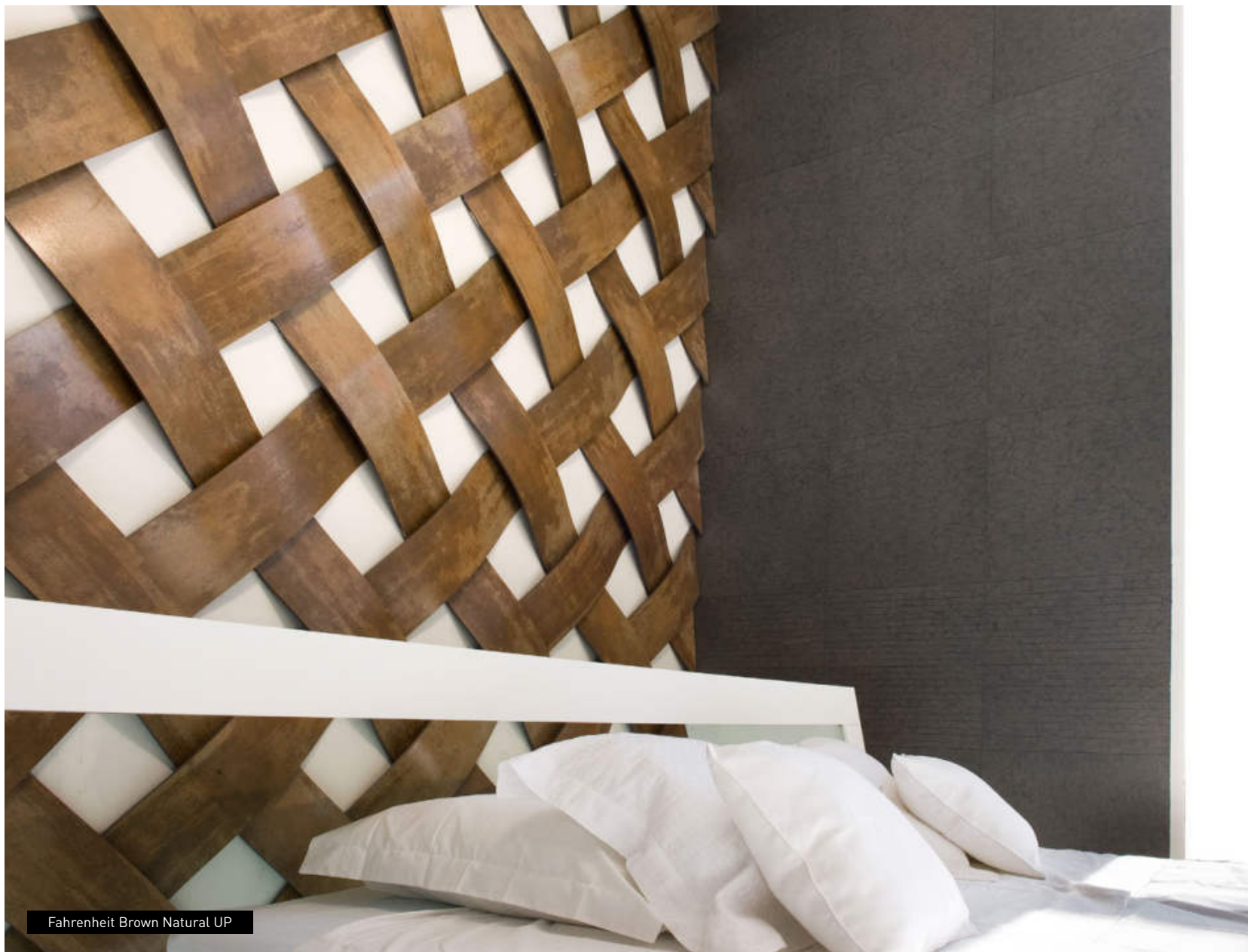

Fahrenheit Brown Natural UP

3D CONCEPT

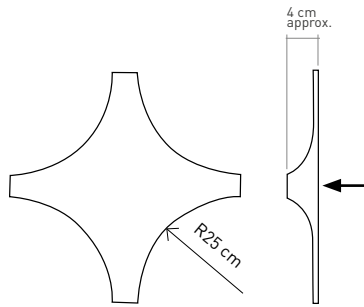

STAR

59,55 x 58,88 cm - 23.45" x 23.18"

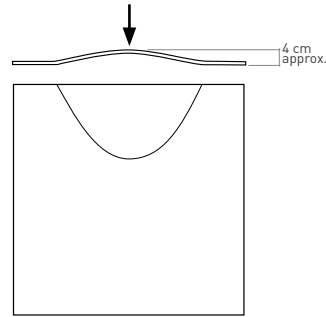

BAG

89,46 x 89,46 cm - 35.22" x 35.22"
59,55 x 59,55 cm - 23.45" x 23.45"
44,63 x 89,46 cm - 17.57" x 35.22"

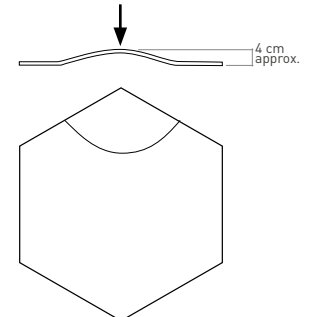

HEXAGONAL BAG

51,57 x 59,55 cm - 20.30" x 23.45"



3-DIMENSIONAL PIECES. PEZZI TRIDIMENSIONALE. PIEZAS TRIDIMENSIONALES.

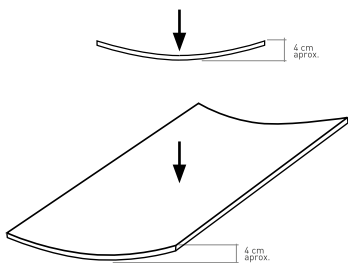

CAVE

44,10 x 89,46 cm - 17.36" x 35.22"

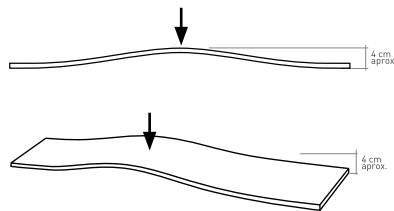

UP

19,71 x 118,80 cm - 7.76" x 46.77"
 14,74 x 118,80 cm - 5.80" x 46.77"
 29,75 x 88,80 cm - 11.71" x 34.96"
 22,21 x 88,80 cm - 8.74" x 34.96"
 14,74 x 88,80 cm - 5.80" x 34.96"

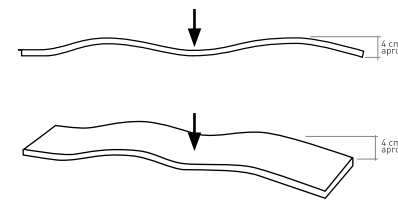

UP-2

19,71 x 118,80 cm - 7.76" x 46.77"
 14,74 x 118,80 cm - 5.80" x 46.77"
 29,75 x 88,80 cm - 11.71" x 34.96"
 22,21 x 88,80 cm - 8.74" x 34.96"
 14,74 x 88,80 cm - 5.80" x 34.96"

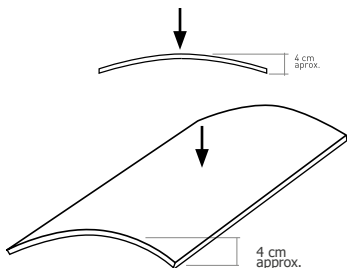

VEXA

44,10 x 89,46 cm - 17.36" x 35.22"

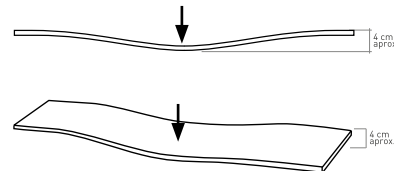

DOWN

19,71 x 118,80 cm - 7.76" x 46.77"
 14,74 x 118,80 cm - 5.80" x 46.77"
 29,75 x 88,80 cm - 11.71" x 34.96"
 22,21 x 88,80 cm - 8.74" x 34.96"
 14,74 x 88,80 cm - 5.80" x 34.96"

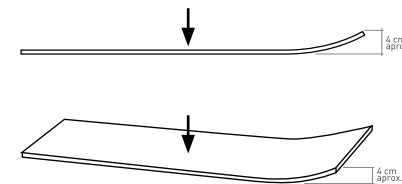

END - UP

19,71 x 118,80 cm - 7.76" x 46.77"
 14,74 x 118,80 cm - 5.80" x 46.77"
 29,75 x 88,80 cm - 11.71" x 34.96"
 22,21 x 88,80 cm - 8.74" x 34.96"
 14,74 x 88,80 cm - 5.80" x 34.96"

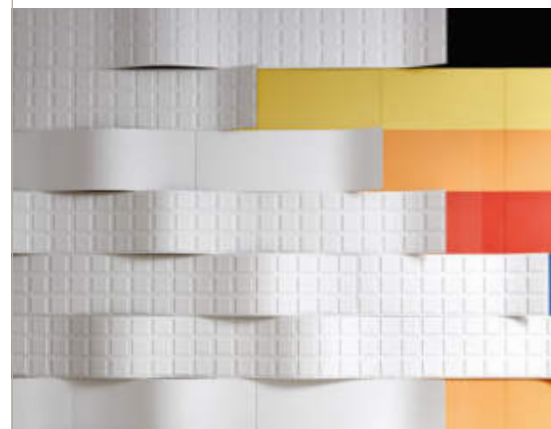
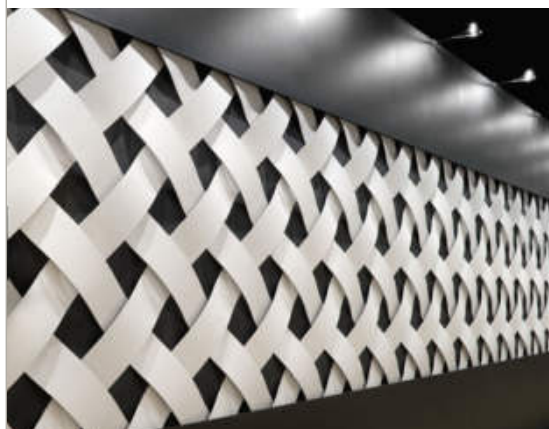

*Check prices and the availability to manufacture the different "3Dimensional" pieces with the items of the LAND PORCELANICO's collections with our commercial network.

Consulten precios y la posibilidad de realizar las diferentes piezas "3Dimensional" con los materiales de las diferentes colecciones de LAND PORCELANICO con nuestra red comercial.

VENTILATED FAÇADES. FACCIATE VENTILATE. FACHADAS VENTILADAS.

The Ventilated Façade system is an exterior cladding system for buildings offering a combination between the maximum level of aesthetic appeal and technical advantages for any new building or renovation.

From the structural point of view, this is a system composed of an external facade made of porcelain stoneware slabs that are mechanically anchored to the perimeter framework of the building by means of a structure in aluminium alloy. Due to the particular characteristics of this construction technique, the surface of the cladding remains separate from the masonry. The resulting cavity is partially occupied by a layer of thermal insulating material, leaving the rest of the space empty to allow ventilation. Therefore a continuous flow of aeration is created providing significant benefits such as:

- Energy saving, thermal insulation and sound proofing. Protection against water.
- Healthier environment - in terms of breathability and a decrease of heat loads.
- No deterioration of the appearance or technical structure over time.
- Exceptional results in renovation works.
- Security when fixing coatings due to the mechanical and chemical anchorage.
- Easy to clean, maintain and manipulate.

TYPES OF SYSTEMS

Visible system: The anchorage of the material by mounting clips, causes it to be visible from the outside. This system does not require any manipulation of the pieces.

Hidden system: The anchorage takes place by using the side grooves that have to be made on the profiles of every piece of porcelain in order for the clips not to be seen from the outside.

La facciata ventilata in ceramica è un sistema di rivestimento esterno degli edifici ideale nell'abbinare il massimo livello di appeal estetico con le migliori prestazioni termiche. Dal punto di vista strutturale si presenta come un sistema a sbalzo, costituito da un paramento esterno in lastre di gres porcellanato fissato meccanicamente all'intelaiatura perimetrale dell'edificio attraverso una struttura in lega di alluminio. Grazie a quest'aparticolare tecnica costruttiva, la superficie del rivestimento resta separata dalla muratura. L'intercapedine che ne risulta viene parzialmente occupata da uno strato di materiale termoisolante, lasciando vuoto il resto dello spazio per consentire la ventilazione. Viene così a crearsi una "lama d'aria", cioè un flusso continuo di aerazione, che apporta significativi benefici in termini di traspirabilità e di diminuzione dei carichi termici.

VANTAGGI:

- Risparmio energetico e isolamento termico.
- Protezione dall'acqua.
- Maggiore salubrità dell'ambiente.
- Nessun deterioramento estetico e tecnico.
- Eccezionale nelle ristrutturazioni.
- Isolamento acustico.

La fachada cerámica ventilada es un sistema de revestimiento exterior de edificios, la combinación ideal entre el máximo nivel estético y las mejores características térmicas. Desde el punto de vista estructural, es un sistema voladizo, compuesto de una cara externa de piezas de gres porcelánico fijadas mecánicamente al perímetro del edificio por medio de una estructura de perfiles de aluminio. Gracias a esta técnica la superficie del revestimiento se mantiene separada de la mampostería. La cavidad resultante está parcialmente ocupada por una capa de material aislante térmico, dejando el resto del espacio vacío para permitir la ventilación. De esta manera se crea un flujo continuo de aireación, que proporciona beneficios significativos en términos de transpirabilidad y una disminución de las cargas térmicas.

VENTAJAS:

- Ahorro de energía y aislamiento térmico.
- Protección contra el agua.
- Medio ambiente más saludable.
- Sin deterioro del aspecto de la fachada exterior ni de las características técnicas por el paso del tiempo.
- Resultados excepcionales en obras de renovación.
- Mayor aislamiento acústico.

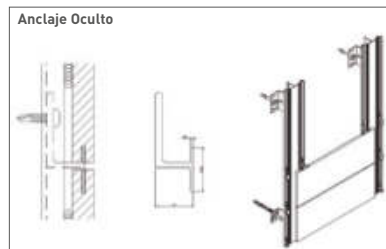
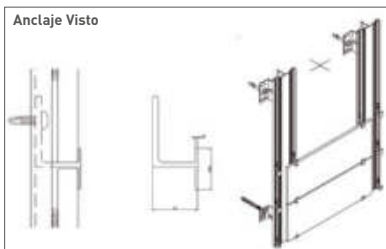

PRIVATE HOUSE
Ourense, Galicia (SPAIN)
AUSTRAL Collection

GLUED FAÇADES WITH MECHANICAL ANCHORAGE. PARETI CON ANCORAGGIO MECCANICO. FACHADAS PEGADAS CON ANCLAJE MECÁNICO.

The Bonded Façade system upgrades the appearance of façades as they provide a modern and innovative appearance that will be durable in time due to the use of our high-end technical porcelain. Currently, there are adhesives that enable an optimum bonding on the façade, however, in order to ensure maximum security, it is important to use a safety mechanical anchorage system that may be visible or hidden. This system offers the following benefits:

- Greater impermeability and resistance against humidity and atmospheric agents.
- Lighter weight in comparison to façades made up of other materials.
- Minimum maintenance required.
- Energy efficiency gain.

La facciata incollata aumenta il valore estetico del rivestimento in porcellanato di alta qualità, con altri vantaggi come la leggerezza, una grande resistenza agli agenti chimici ed atmosferici, creando edifici con finiture innovative e durature nel tempo. Attualmente ci sono adesivi che permettono di migliorare l'incollaggio del materiale sulla facciata ma per garantire la sicurezza contro eventuali distaccamenti delle mattonelle stesse sono stati progettati sistemi di fissaggio con ancoraggio meccanico a vista o a scomparsa.

VANTAGGI:

- Migliore isolamento contro l'umidità e resistenza agli agenti atmosferici.
- Aumento impermeabilità.
- Meno peso rispetto ad altre facciate installate con altri materiali.
- Manutenzione minima.

La fachada pegada incrementa el valor estético del revestimiento porcelánico de alta calidad, con otros aspectos, como la ligereza y un gran comportamiento ante agentes químicos y atmosféricos, dotando a los edificios de un acabado innovador y perdurable en el tiempo. En la actualidad, existen adhesivos que nos permiten mejorar el aplacado en la fachada. Pero para garantizar la seguridad de la misma ante posibles desprendimientos de las baldosas, se han diseñado sistemas de fijación con anclaje mecánico oculto y visto para su colocación.

VENTAJAS:

- Mejor comportamiento frente a la humedad y los agentes atmosféricos.
- Mayor impermeabilidad.
- Menor peso respecto a otras fachadas con otros materiales.
- Mínimo mantenimiento.

For pricing on grooved material for hidden system, please check with our commercial department. Precios de material ranurado para sistema oculto, consultar con el departamento comercial.

AVERAGE QUANTITY ANCHORING / M2. CONSUMO MEDIO ANCLAJES / M2.

SIZE TILE	UNITS/M2
60x120 cm	3 units/m2
90x90 cm	3 units/m2
45x90 cm	5,5 units/m2
60x60 cm	6,5 units/m2
30x60 cm	12 units/m2

Variable depending on the project.
Variable en función del proyecto.

ANCHORING PRICES. PRECIOS ANCLAJES.

REFERENCES (inox)	JOINT approx. JUNTA aprox	PRICE. PRECIO unit.
Oculto U - 8	8 mm	G-5027
Visto U - 8	8 mm	G-5029
Oculto Z - 1	1 mm	G-5033
Visto Z - 1	1 mm	G-5037

The price includes staple, plug and screw.
El precio incluye grapa, taco y tornillo.



U-8 basic
U-8 continuación



U-8 / Z-1 ending
U-8 / Z-1 terminación



Z-1 basic
Z-1 continuación

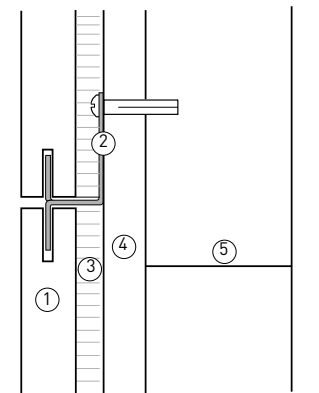

1. Porcelain tile. Porcelánico.
2. Invisible mechanical anchorage. Anclaje mecánico oculto.
3. Adhesive. Adhesivo.
4. Mortar. Mortero.
5. Solid brick. Ladrillo macizo.



CONSORCI SANITARI GARRAF
Barcelona. (SPAIN)
PIETRA SERENA Collection

GLUED FACADE. FACHADA APLACADA CON GRAPA OCULTA

INTERIOR RAISED FLOORS. PAVIMENTI SOPRAELEVATI INTERNI. PAVIMENTO SOBREELEVADO INTERNO.



The Raised Floor system for interior spaces is a technical solution for new buildings and refurbishments that will raise the functional floor surface from the floor substrate in order to offer the following advantages:

Flexibility in the distribution of the spaces, as the panels can be easily removed and re-positioned.
 Practicality in maintenance operations as the panels can be lifted to reach all technical elements beneath.
 Versatility as the raised floor can also be positioned over a pre-existing floor and can be used to level surfaces with different heights.
 Aesthetic qualities as this surface guarantees excellent maintainance and durability over time.

This system is composed of two main elements: the panel and its support structure. The panel, is made by gluing a finishing slab of porcelain onto a 3-4 cm support. It is supported by a metallic frame consisting of crossbeams and adjustable pedestal for height adjustment giving a void space between floor substrate and the functional surface. In the technical space concealed between the substrate and the floor, any type of technical plant or equipment can be housed. The minimum height of the floor with respect to the support surface varies from 7 to 8 cm, so the solution of the raised floor can also be adapted to pre-existing floors.



Il pavimento sopraelevato si compone di due elementi principali: il pannello e la sua struttura di sostegno. Il pannello, è il risultato dell'incollaggio di un supporto di 3-4 cm con una lastra di finitura in gres. La lastra costituisce il piano di calpestio, garantendo qualità estetiche ed eccellenti caratteristiche di pulibilità, inalterabilità e resistenza nel tempo. Nello spazio tecnico nascosto tra il fondo e il pavimento è possibile alloggiare qualsiasi tipo di impianti e servizi. L'altezza minima della pavimentazione rispetto al piano d'appoggio varia dai 7 agli 8 cm, per cui la soluzione del pavimento sopraelevato si può adattare anche al caso di pavimenti preesistenti. Il materiale porcelanico dovrebbe essere di formato 59,55x59,55 cm.

VANTAGGI:

Praticità nelle operazioni di manutenzione grazie all'accessibilità degli impianti.
 Flessibilità nella distribuzione degli ambienti e nella loro successiva rimodulazione.
 Versatilità. Il pavimento sopraelevato può essere posizionato anche su un pavimento preesistente e può essere utilizzato per raccordare piani con altezze diverse.
 Possibilità di riutilizzo. La posa a secco senza l'uso di collanti permette la movimentazione dei singoli pannelli o di tutta la pavimentazione in ambienti diversi da quelli iniziali.

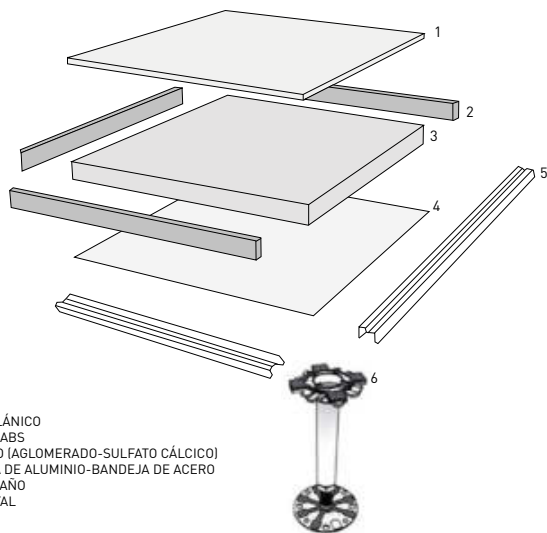

1. PORCELÁNICO
2. PERFIL ABS
3. NÚCLEO (AGLOMERADO-SULFATO CÁLCICO)
4. LÁMINA DE ALUMINIO-BANDEJA DE ACERO
5. TRAVESAÑO
6. PEDESTAL

El sistema de suelo sobreelevado técnico está compuesto por dos elementos principales: el panel y su estructura de apoyo. El panel, se realiza pegando la pieza de porcelánico sobre un soporte de 3-4 cm. La pieza va montada sobre una marco metálico con unos travesaños y unos pedestales de altura ajustable para dejar un espacio vacío entre el suelo y la superficie de tránsito. El porcelánico constituye esta superficie transitable, para garantizar la calidad estética, la facilidad de limpieza, inalterabilidad y durabilidad en el tiempo. Cualquier tipo de conexiones o equipos pueden ser alojados en el espacio oculto entre el substrato y la superficie. La altura mínima de la suelo con respecto a la superficie de soporte varía de 7 a 8 cm, por lo que la solución de suelo elevado también puede adaptarse a pavimentos ya existentes. El material porcelánico a utilizar en la parte superior debe ser de formato 59,55x59,55 cm.

VENTAJAS:

Accesibilidad. Facilidad en el mantenimiento debido al fácil acceso al espacio entre suelo y pavimento.
 Flexibilidad en la distribución de los espacios y remodelación, por la facilidad de sacar las piezas y moverlas a otra posición.
 Versatilidad. El suelo sobreelevado puede ser colocado sobre un piso ya existente y se puede utilizar para unir superficies de diferentes alturas.
 Posibilidad de reutilización. La colocación de las capas de suelo sin uso de adhesivo ofrece la posibilidad de cambio de ubicación de algunas piezas o del suelo entero.

EXTERIOR RAISED FLOORS. PAVIMENTI SOPRAELEVATI ESTERNI. PAVIMENTO SOBREELEVADO EXTERNO.

The Exterior Raised Flooring system offers the possibility of having flat paved surfaces suitable for traffic in outdoor areas that may or may not have slopes (up to a 3% inclination). At the same time, it offers a ventilated cover with perfect drainage of the paved surface performing the filtration of water through the joints between tiles as well as better maintenance and greater insulation. This system of an easy installation is formed by 20mm tiles (either one individual piece of 20mm or two pieces of 10mm glued together), placed on a support base that are the PLOTS, made of polypropylene. With these, it is possible to create a space between the tiles and the surface, which can be on a rooftop or a terrace, and that will be used for passage of pipes. The tiles can be easily moved around without losing any stability. There are two types of plots: fixed (15 mm height) for flat areas or adjustable (from 65 mm to 310 mm height) to solve any levelling issues in outdoor areas.

I pavimenti calpestabili sopraelevati da esterno sono costituiti da una piastrella di dimensioni standard (2 pezzi incollati) installata su di una base in polipropilene chiamato PLOTS al fine di creare uno spazio, chiamato plenum, tra essa e la superficie, che può essere un tetto o terrazzo, e che può essere utilizzato per il passaggio di tubi. Possiamo quindi ottenere superfici piane pavimentate adatte al calpestio con pendenze (sempre inferiori al 3%) con il vantaggio di una più facile manutenzione ed una maggiore coibentazione. Le pezzi possono essere sostituiti e scambiati con altri sistemi senza perdita di stabilità. Qualsiasi formato dei modelli di porcellana di questo catalogo può essere utilizzato per questo sistema. È possibile ottenere una copertura ventilata con un perfetto drenaggio eseguendo solo il recupero delle acque creato dalle fughe tra le piastrelle. Staffe fisse in polipropilene (altezza 15 mm) o regolabili (da 65 mm a 310 mm di altezza) completano il sistema adatto a risolvere tutte le soluzioni di pavimenti esterni sopraelevati.

Los pavimentos transitables elevados para exteriores, están formados por baldosas de una medida standard (2 piezas pegadas), instaladas sobre unas bases, denominadas PLOTS de polipropileno, para crear un espacio entre éste y la superficie, que puede ser una azotea o terraza exterior, llamado plenum que puede ser utilizado para paso de canalizaciones. De este modo conseguimos superficies pavimentadas planas y aptas para el tránsito sobre suelos con pendientes (siempre inferiores al 3%), con la ventaja de un mejor mantenimiento y un mayor aislamiento térmico. Para este sistema se puede utilizar cualquier formato de los modelos de porcelánico del catálogo. Se consigue una cubierta ventilada, con un perfecto drenaje de la superficie pavimentada, realizándose la filtración del agua por las juntas entre baldosas. Las piezas se pueden sustituir e intercambiar por otras del sistema sin pérdida de estabilidad. Los soportes fijos (de 15 mm alto) o regulables (desde 65 mm a 310 mm) en polipropileno completan el sistema, apto para resolver todas las soluciones de sobreelevaciones para exteriores.



TECHNICAL SOLUTIONS

AVERAGE QUANTITY PLOTS / M2. CONSUMO MEDIO PLOTS / M2.

SIZE TILE	PLOTS/M2
60x120 cm	3 units/m2
90x90 cm	5,5 units/m2
22,5x90 cm	11 units/m2
45x90 cm	5,5 units/m2
60x60 cm	3 units/m2
30x60 cm	6 units/m2

Variable depending on the project.
Variable en función del proyecto.

PLOTS PRICES. PRECIOS PLOTS.

REFERENCES	HEIGHT ADJUSTMENT. REGULACIÓN ALTURA	UNIT PRICE. PRECIO UNITARIO	ALLOWABLE LOAD. CARGA ADMISIBLE
PLOT SNR 15	15 mm (fix. fija)	G-5039	6000 kg
PLOT SR 65/100	de 65 a 100 mm	G-5075	2500 kg
PLOT SR 100/130	de 100 a 130 mm	G-5079	2500 kg
PLOT SR 130/220	de 130 a 220 mm	G-5085	2200 kg
PLOT SR 220/310	de 220 a 310 mm	G-5100	2000 kg

For pricing on 2cm glued tiles please check with the commercial department.
Precio doble pieza pegada, consultar con el departamento comercial.

Numéro de décision: 594/804-0.0/14 du 09 janvier 2015

Liste des carreaux GRÈS PRESSÉ NON ÉMAILLÉ - Groupe: Bla

Série commerciale : **AZULCASCAIS NATURAL**

Particularité : Décorés - Option glissance non revendiquée

Comportement au gel : Satisfaisant selon essai normalisé

Dimensions	Epaisseur	Particularité	Coloris	Classement
595.5 x 595.5	10.3	Rectifié	Ivory	U4 P4+ E3 C2
595.5 x 595.5	10.3	Rectifié	Moss	U4 P4+ E3 C2

Série commerciale : **CIVIC**

Particularité : Option glissance non revendiquée

Comportement au gel : Satisfaisant selon essai normalisé

Dimensions	Epaisseur	Particularité	Coloris	Classement
595.5 x 595.5	10.3	Rectifié	Antracita	U4 P4+ E3 C2
595.5 x 595.5	10.3	Rectifié	Grey	U4 P4+ E3 C2
595.5 x 595.5	10.3	Rectifié	Ivory	U4 P4+ E3 C2

Série commerciale : **GALLERY POLI**

Particularité : Option glissance non revendiquée

Comportement au gel : Satisfaisant selon essai normalisé

Dimensions	Epaisseur	Particularité	Coloris	Classement
297.5 x 595.5	9.0	Rectifié	Blue	U3 P3 E3 C2
297.5 x 595.5	9.0	Rectifié	Lime	U3 P3 E3 C2
297.5 x 595.5	9.0	Rectifié	Orange	U3 P3 E3 C2
297.5 x 595.5	9.0	Rectifié	White	U3 P3 E3 C2

Série commerciale : **PIETRA SERENA NATURAL**

Particularité : Décorés - Option glissance non revendiquée

Comportement au gel : Satisfaisant selon essai normalisé

Dimensions	Epaisseur	Particularité	Coloris	Classement
595.5 x 595.5	10.3	Rectifié	Beige	U4 P4+ E3 C2
595.5 x 595.5	10.3	Rectifié	Graphite	U4 P4+ E3 C2
595.5 x 595.5	10.3	Rectifié	Ivory	U4 P4+ E3 C2
595.5 x 595.5	10.3	Rectifié	Moss	U4 P4+ E3 C2

Per toute information concernant les données techniques sur la classification UPEC, nous vous prions de bien vouloir consulter la version française de site www.landporcelanico.com

SLIP RESISTANCE. PROPRIETÀ ANTISCIVOLO. RESBALADICIDAD.

DIN 51130 *

(Average angle of acceptance)

(Ángulo de aceptación medio)

R9	R10	R11	R12
6°-10°	10°-19°	19°-27°	27°-35°
<ul style="list-style-type: none"> • Austral • Azulcascais natural • Celtic • Civic natural • Dagon natural • Gallery satinado • Ismo natural • Jamtland natural • Jerusalem natural • Matter natural • Mensa natural • Midland natural • Origin natural • Pietra Serena natural • Portland natural 	<ul style="list-style-type: none"> • Azulcascais natural • Kankare natural • Legno • Matter lappato • Nouveau natural • Portland lappato • Rambla natural • Warm natural 	<ul style="list-style-type: none"> • Mensa non slip • Midland corrugato • Pietra Serena filosega • Pietra Serena rigato • Roots 	<ul style="list-style-type: none"> • Azulcascais estructurado • Pietra Serena bocciardato

UNE-ENV 12633 *

(ENSAYO DEL PÉNDULO) Clasificación de los suelos según la norma.

CLASE 1	CLASE 2	CLASE 3
15<Rd<35	35<Rd<45	Rd > 45
<ul style="list-style-type: none"> • Austral • Azulcascais natural • Celtic • Civic natural • Dagon natural / lappato • Gallery satinado • Ismo natural / lappato • Jamtland natural / lappato • Jerusalem natural • Kankare natural • Legno • Matter natural • Mensa natural • Midland natural • Nouveau natural/lappato • Origin natural / lappato • Pietra Serena natural / lappato • Portland natural 	<ul style="list-style-type: none"> • Matter lappato • Portland lappato • Rambla natural 	<ul style="list-style-type: none"> • Azulcascais estructurado • Mensa non slip • Pietra Serena bocciardato • Pietra Serena filosega • Pietra Serena rigato • Roots • Midland corrugato

ANTISLIP PROPERTIES

* Theoretical classification. For projects, check the values given above, with our commercial network before ordering. For any further tests required, contact us.

* Classificazione teorica. Per i progetti, verificare i valori di sopra, prima della conferma dell'ordine con la nostra rete commerciale.

* Clasificación teórica. Consultar con nuestra red técnico-comercial los valores indicados antes de la confirmación del pedido para proyectos.

Ensayos realizados en laboratorio interno. / Tests realized in internal laboratories

CTE Código Técnico de Edificación	USO PRIVADO			USO PÚBLICO
	Interior seco	Interior húmedo	Exterior	Edificios públicos (hospitales, gimnasios,...)
CLASE 1	Pendiente < 6%	—	—	—
CLASE 2	Pendiente ≥ 6% Escaleras	Pendiente < 6%	—	Interiores cubiertos
CLASE 3	—	≥ Pendiente ≥ 6% Escaleras	- Piscinas - Duchas - Terrazas	- Hall entrada - Terraza - Vestuario / baño - Cocina - Sala instalaciones / maquinaria

Fuente: Código Técnico de la Edificación / DB-SUA-Seguridad de Utilización y Accesibilidad / 1.1. Seguridad frente a caídas.

CERTIFICATES. CERTIFICAZIONI. CERTIFICADOS.

LAND PORCELANICO carries out laboratory tests to set the technical characteristics of each one of its products (measurements and surfaces appearance) and certify that it applies the current norms.

LAND PORCELANICO effettua test di laboratorio per verificare che siano rispettate le caratteristiche tecniche di ciascuno dei propri prodotti (misurazioni e aspetto superficiale) e certifica che questi siano conformi alle norme attuali.

LAND PORCELANICO realiza ensayos de laboratorio para determinar las características técnicas de cada uno de sus productos (medidas y aspecto superficial) y certificar que se cumple con la normativa vigente.

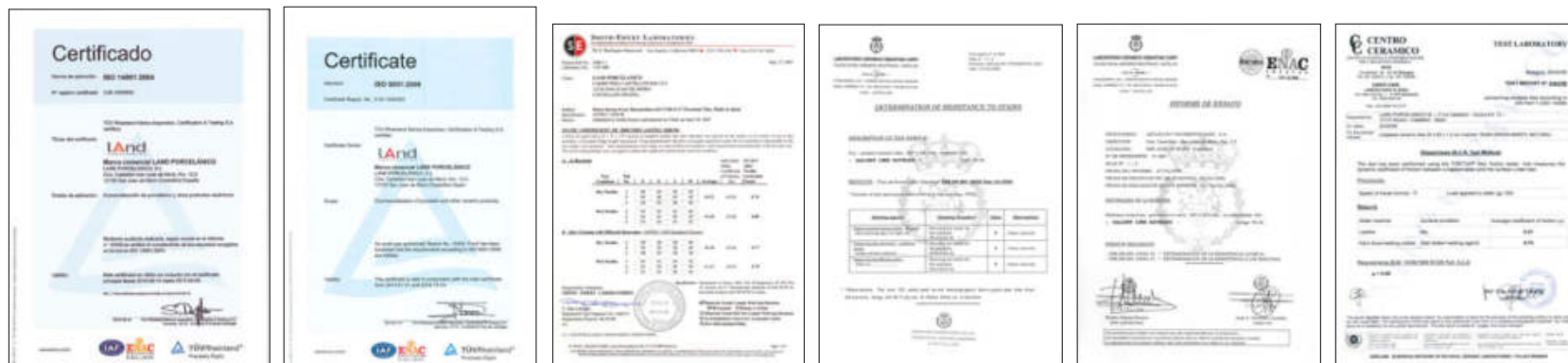

CERTIFICATE ISO 14001: 2004

Environmental manage system

Sistema de gestión ambiental

CERTIFICATE ISO 9001: 2008

Certifications issued for LAND PORCELANICO materials by the following official bodies:

Certificazioni rilasciate per i prodotto LAND PORCELANICO dai seguenti organismi ufficiali:

Certificados emitidos para el producto de LAND PORCELANICO por los siguientes organismos oficiales:



COMPLIANCE WITH CREDITS FOR

LEED
CERTIFICATION SYSTEM



YOU CAN OBTAIN UP TO **38 LEED CREDITS**. SE PUEDEN OBTENER HASTA 38 **CRÉDITOS LEED**

depending on the following criteria:
dependiendo de los siguientes criterios:

DIRECT CREDITS

SUSTAINABLE SITES:

- SS 1/7** HEAT ISLAND EFFECT. EFECTO ISLA DE CALOR
- SS 3** LOCAL HEAT ISLAND EFFECT. EFECTO ISLA DE CALOR LOCAL

1-2
CREDITS

MATERIALS AND RESOURCES:

- MR** RECYCLED CONTENT. CONTENIDO RECICLADO
- MR** REGIONAL MATERIALS. MATERIALES REGIONALES
- MR** SUSTAINABLE PURCHASING. ADQUISICIÓN SOSTENIBLE
- MR** SUSTAINABLY SOURCED MATERIALS & PRODUCTS. PRODUCTOS Y MATERIAS PRIMAS SOSTENIBLES
- MR** ENVIRONMENTALLY PREFERABLE PRODUCTS. PRODUCTOS AMBIENTALMENTE PREFERIBLES

0,5-8
CREDITS

INDOOR ENVIRONMENTAL QUALITY

- IEQ** LOW EMITTING MATERIALS. PRODUCTOS DE BAJA EMISIÓN

1-4
CREDITS

INDIRECT CREDITS

ENERGY & ATMOSPHERE

- EA PR2** MINIMUM ENERGY PERFORMANCE. EFICIENCIA ENERGÉTICA MÍNIMA
- EA CR1** OPTIMIZE ENERGY PERFORMANCE. OPTIMIZACIÓN ENERGÉTICA

1-21
CREDITS

MATERIALS AND RESOURCES

- MR CR1.2** BUILDING REUSE. REUTILIZACIÓN DEL EDIFICIO
- MR CR3** MATERIALS REUSE. REUTILIZACIÓN DE MATERIALES

1-2
CREDITS

INDOOR ENVIRONMENTAL QUALITY

- IEQ CR3** CONSTRUCTION INDOOR AIR QUALITY MANAGEMENT PLAN. PLAN DE GESTIÓN DE LA CALIDAD DE AIRE INTERIOR

1
CREDIT

CoverLEED | jtc | Land

CERTIFICATE
ISO 14001: 2004

Environmental manage system
Sistema de gestión ambiental



INTEGRATED ENVIRONMENTAL AUTHORIZATION (issued by The Center for Climate Change, at the Environment, Water and Urban Development Council of Comunidad Valenciana, according to a resolution dated 28th of November, 2007. 2008/1866).

AUTORIZACIÓN AMBIENTAL INTEGRADA (otorgada por la Dirección General para el Cambio Climático, de la Conselleria de Medio Ambiente, Agua, Urbanismo y Vivienda de la Comunidad Valenciana, según resolución del 28 de Noviembre de 2007. 2008/1866).



ADVICES FOR FIXING PORCELAIN TILES. CONSIGLI PER LA POSA DEL GRES PORCELLANATO. CONSEJOS PARA LA COLOCACIÓN DEL PORCELÁNICO.



COCA - COLA OFFICES
Rattingen. (GERMANY)
Arch. RKW ARCHITEKTUR / STADTEBAU

TILING. The support base for wall or floor for the tiles must be stable, dry, flat and it must have the adequate consistency. This base must never be too hot nor too cold and should be clean. One must not forget to clean any dust, grease or oil leftovers to facilitate an optimal adhesion. It is convenient to use slightly rough support bases, altering any excessively smooth leveling layer, in order to ensure great adherence.

ACONDICIONAMIENTO DEL FONDO. El fondo o soporte para pared o suelo sobre el que se colocarán las baldosas debe estar estable, seco, y limpio sin restos de polvo, grasa o aceite. Es conveniente disponer de soportes rugosos alterando los soportes excesivamente lisos o la propia capa de nivelación ligeramente para garantizar mayor adhesión.

FIXER MATERIALS TO USE. The type of adhesive will be determined by the water absorption of each type of tile. In our case, it is advisable to employ the technique of placing a thin layer of cement adhesive of type C2. For formats larger than 30x30cm, we recommend to double-layer-adhesive. This technique involves the appliance of adhesive on the support base as well as on the tile; this technique is strongly recommended for outdoors.

The bonding material must be applied with serrated edged comb to achieve a homogenous adhesive distribution throughout the laying surface, even in the corners of the tile. A non-uniform adhesive layer will cause tensions on the tile, which will create an "eyebow" effect. It is advisable to follow the instructions of the adhesive manufacturer, particularly for different cement-based bonding materials.

ADHESIVOS A EMPLEAR. La elección del tipo de adhesivo vendrá determinada por la absorción del agua de cada tipo de baldosa. En nuestro caso, se aconseja emplear la técnica de colocación en capa fina con el uso de Adhesivos Cementosos tipo C2. Para grandes formatos superiores a 30x30cm, se recomienda la técnica de colocación de doble encolado, esto es, aplicar adhesivo sobre el soporte y en la baldosa, en especial en exteriores. El material de agarre debe aplicarse con una llana dentada para conseguir una distribución del adhesivo homogénea por toda la superficie de colocación incluso en las esquinas de la baldosa, presionando la baldosa sobre el adhesivo todavía fresco. De no ser uniforme la capa de adhesivo provocará tensiones en la baldosa que generan a la larga el efecto "ceja".

FIXING. The previous handling of the tiles, especially the rectified, must be done with utmost care to avoid scratches or chipping of the tiles. During the fixing process, the surface shall not be marked by graphite materials (pencils) or permanent markers, especially in the case of polished products to avoid potential cleaning problems.

In the placement of tiles the use of at least 2mm spreaders is advisable. For locked placement, it is advisable to fix at a distance from 1/3 of the piece, never at half of the piece. In large format porcelain pieces (over 60cm of any of its sides) it is convenient to use leveling clips to ensure the flatness of the pieces.

COLOCACIÓN. La manipulación previa de las baldosas, en especial las rectificadas, ha de realizarse en el máximo cuidado, para evitar despuntados, rayas o desconchados en su superficie. Durante la colocación, no deberá marcarse la superficie de utilización con lápices (grafito) o rotuladores indelebles, especialmente en el caso de los productos pulidos para evitar posibles problemas de limpieza de los mismos. En la colocación de las baldosas se recomienda el uso de cruceetas de al menos 2mm. En colocación trabada es aconsejable la colocación a una distancia de 1/3 de la pieza, nunca a la mitad de la pieza. En pavimentos de grandes formatos (mayores de 60cm en alguno de sus lados) es conveniente el uso de un sistema de nivelación para garantizar la planitud de las piezas (disponibles en el mercado de varios fabricantes).

ADVICES FOR CLEANING PORCELAIN TILES. CONSIGLI PER LA PULIZIA DEL GRES PORCELLANATO. CONSEJOS PARA LA LIMPIEZA DEL PORCELÁNICO.

ASSEMBLY JOINTS AND EXPANSION. The main functions of installation joints are: to absorb deformations of the support, to increase surface adhesion between the parts and the bonding material, and to improve the impermeability of the surface. It is necessary to respect the indications given below:

- Structural joints: the construction project already takes into account the existence of these joints in the floor coverings. These must also abide when covering the joint with plastic trims.
- Perimeter joints: it is always appropriate to provide these joints that insulate the tile and bonding material from any structural movements, avoiding tensions with them. Perimeter joints are normally hidden by the skirting board or the tile itself; they must have a width of 5 to 10 mm, and may be empty or filled with deformable material.
- Expansion joints: allow deformations due to thermal and hygroscopic variations between tiles, the bonding material and the support base. Usually designed with a width of 5-8 mm and surfaces from 25m² (in sections of 5x5 m²) indoors, and from 9m² outdoors. These joints must be well executed, this means that they must be flexible, waterproof, well bonded and must reach the base support.
- Installation joints: those between tiles. Before grouting these must be empty, without any bonding materials. It is not recommended to fix any floor without joints, advising a minimum joint of 2-3 mm. The grout used in installation joints must be applied with a rubber float. The market offers a wide range of grouts, which are suitable for each type of tile and temperature as specified by the manufacturer of the grout, in which the type of product to be used, colors and waiting time before grouting should be recommended.

Before grouting, it is advisable to test a small area of the part to determine whether the chosen grout affects or stains the surface of the piece. In this case, one should contact the grout manufacturer. Ask the manufacturer for a suitable cleaner for this type of grip material. A bonding material with a thin granulometry is desirable in order to avoid scratches on the tile during its placement.

JUNTAS DE COLOCACIÓN. Las principales funciones de las juntas de colocación son: absorber las deformaciones del soporte, aumentar la adhesión de superficie entre las piezas y el material de agarre, y mejorar la impermeabilidad de la superficie. Es conveniente respetar las indicaciones dadas a continuación:

- Juntas estructurales: el proyecto de construcción ya tiene en cuenta la existencia de estas juntas en los revestimientos para el suelo. Estos también deben atenerse a cubrir la junta con embellecedores de plástico.
- Las juntas perimetrales: siempre es apropiado para prever estas juntas que aíslan la baldosa y al adhesivo de los movimientos estructurales, evitando tensiones con ello. Las juntas perimetrales quedan normalmente ocultas por el rodapié o el propio azulejo; deben tener una anchura de 5 a 10 mm, y pueden quedar vacías o llenas de material deformable.
- Juntas de expansión: permiten deformaciones debidas a las variaciones térmicas e higroscópicas entre las baldosas, el adhesivo y el soporte. Normalmente se diseñan con una anchura mínima de 5-8 mm y en superficies a partir de 25m² (en paños de 5x5 m²) en interiores, y en superficies a partir de 9m² en exteriores. Estas juntas deben estar bien ejecutados, esto significa que deben ser flexibles, impermeables, estar bien adheridas y deberán llegar a el soporte base.
- Las juntas de colocación: son las existentes entre baldosa y baldosa. Antes del rejuntado éstas debe estar vacías. Se desaconseja una colocación a junta unida o a "testa", aconsejándose una junta mínima de 2-3mm. El material de rejuntado utilizado en juntas de colocación se debe aplicar con una llana de goma. El mercado ofrece una amplia gama de materiales de rejuntado, que se adecuan a cada tipo de baldosa y ambiente según especificaciones del fabricante del material de rejuntado, en las que se debe recomendar el tipo de producto a utilizar, los colores y el tiempo de espera hasta el comienzo del rejuntado.

Antes del rejuntado, es conveniente probar en un área pequeña de la pieza para determinar si el rejunte elegido afecta o mancha de la superficie de la pieza, en cuyo caso, hay que ponerse en contacto con el fabricante del material de rejuntado. Pregunte al fabricante por un limpiador adecuado para este tipo de material. Es recomendable que la granulometría del material de rejuntado sea fina con el fin de evitar arañazos y rayas en la baldosa durante su colocación.

CLEANING AFTER INSTALLATION. The most important cleaning operation is performed immediately after laying the tiles. This involves the complete removal of residues and dirt from the tile placement. An inadequate or late removal of this waste can create a cementitious layer on the tile capable of absorbing all forms of dirt. This may give the impression that the tile gets dirty when the actual problem resides in the surface film of dirt which was not removed immediately after laying.

Once the grouting of the tiles is finished, it is important, while the grout is still wet, to carefully remove any excess material immediately. This can be done using a sponge and plenty of clean water, repeating this as many times as necessary.

Do not perform the cleaning with metal tools, scrapers or abrasive pads. For stubborn stains, clean with alcohol and lukewarm water and rub with a clean cloth. If they do not disappear, check with the relevant technical department.

Once the above mentioned washing is done, another washing should be carried out using basic or alkaline degreasing agents, as acid washing can leave stickiness on the pavement which could help retain dirt. In areas where water is calcareous, it is convenient to dry the surface, in order to prevent the deposition of carbonates which will reduce the surfaces' gleam.

LIMPIEZA DESPUÉS DE LA COLOCACIÓN. La operación de limpieza más importante se realiza inmediatamente después de colocar las baldosas. Esto implica la eliminación completa de los residuos y la suciedad de la colocación de las propias baldosas. Una eliminación inadecuada o tardía de estos residuos puede crear sobre la baldosa una película cementosa capaz de absorber toda forma de suciedad, dando la impresión de que las baldosas se ensucian cuando el problema real reside en la película superficial de suciedad.

Una vez terminado el rejuntado de las baldosas, es importante quitar cuidadosamente cualquier exceso de material inmediatamente mientras el esté todavía húmedo. Esto se puede hacer con una esponja y abundante agua limpia, repitiendo esta operación tantas veces como sea necesario.

No realizar la limpieza con herramientas de metal, rascadores o esponjas abrasivas. Para las manchas difíciles, limpiar con alcohol y agua tibia y frotar con un paño limpio. Si no desaparecen, consulte con el departamento técnico correspondiente.

Una vez efectuado el lavado descrito arriba, deberá efectuarse un nuevo lavado utilizando detergentes desengrasantes básicos o alcalinos, ya que el lavado ácido puede dejar untuosidad en el pavimento, que podría ayudar a retener la suciedad. En las zonas donde el agua es calcárea, es conveniente secar la superficie, con el fin de evitar la deposición de carbonatos que reducirán el brillo superficial.

* Physical Vapor Deposition (PVD)

Pvd is a field in the application of nanotechnology. The process consists of depositing layers of atoms, inside a vacuum chamber, to a solid surface. The layering is produced by the condensation of a vaporized metal (such as gold, titanium, platinum etc.) over the selected surface.

Advantages: Resistance to abrasion and scratches; much higher than metals applied by firing. Corrosion resistant. ISO 9227. As a general rule, any non-aggressive, pH neutral product can be used.

Do not mix pieces from different lots.

DIGITAL PRINTING. STAMPA DIGITALE. IMPRESIÓN DIGITAL.



The digital printing system is a process of decorating ceramic pieces using an ink-jet application to enable the development of high quality photo reproductions (including images, drawings, text, logos, etc...), maintaining the high technical characteristics of our ceramic products.

With our special decoration system, as a result, we can offer pieces of a greater realism due to the fact that it can achieve higher printing resolutions.

Another advantage of this system is the ecological aspect, since by using only four colors (CMYK), the number of materials used in the production are substantially reduced, thereby reducing the extraction of these materials and its environmental impact.

Il sistema di stampa digitale è un processo di decorazione di pezzi ceramici che si effettua mediante l'applicazione di iniezioni (CMYK) che consentono lo sviluppo di parti con riproduzioni fotografiche in alta definizione (tra cui immagini, disegni, testi, loghi, ecc ..), mantenendo le elevate prestazioni del nostro prodotto ceramico.

Con questo processo di decorazione digitale si ottiene un maggiore realismo della foto o disegno stampato sul pezzo, e si può ottenere una risoluzione di stampa più elevata di quella raggiunta finora.

Un altro vantaggio di questo sistema è l'aspetto ecologico, poiché utilizzando quattro colori (CMYK) diminuisce sostanzialmente il numero di materiali utilizzati nella produzione, riducendo così il loro smaltimento e l'impatto ambientale.

El sistema de impresión digital es un proceso de decoración de piezas cerámicas, mediante una aplicación de inyección (CMYK) que posibilita el desarrollo de piezas con reproducciones fotograficas en alta calidad (ya sean imágenes, dibujos, textos, logotipos,..etc), manteniendo las elevadas prestaciones de nuestro producto cerámico.

Con este proceso digital de decoración se consigue un mayor realismo en la fotografía o dibujo impresa en la pieza, ya que se pueden obtener unas resoluciones más altas de impresión que las conseguidas hasta ahora.

Otra de las ventajas de este sistema es el aspecto ecológico, ya que al utilizar 4 colores (CMYK) se reducen sustancialmente el número de materiales utilizados en producción, reduciendo así la extracción de los mismos y su impacto medioambiental.

WATERJET CUTTING. TAGLIO A GETTO D'ACQUA. CORTE DE AGUA.

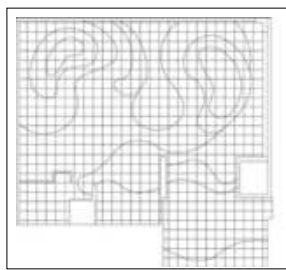

In order to create custom floor designs, usually including borders and center pieces, combining different collections we use the Water Jet system. The Water Jet system is based on a tool that is capable of slicing into porcelain tiles using a water jet at a high speed and pressure, or a mixture of water and an abrasive substances. The process is essentially the same as water erosion found in nature but accelerated and concentrated by orders of magnitude. Water Jet cutters are capable of producing rather intricate cuts in porcelain tiles, in other way impossible to obtain.

The advantages of this system go beyond the final visual results.

- More precise cuts, avoiding tears or unstructured shapes when handling the product.
- Allows precise cuts on thicker pieces with lower net weight.
- Enables any desired design to be manufactured according to what the client wants.

Una tagliapiastrelle a idrogetto è uno strumento capace di tagliare il porcellanato e altri materiali utilizzando unicamente un getto d'una miscela di acqua e sostanze abrasive ad alta pressione. Il processo è essenzialmente uguale a come avviene in natura con l'erosione delle acque, ma accelerato e concentrato. Il taglio a idrogetto è in grado di produrre intricate decorazioni altrimenti impossibili da effettuare.

I vantaggi di questo processo vanno al di là e della semplice estetica.

- Il taglio è di migliore qualità e non produce deformazioni causate dallo sforzo o dall'aumento del calore.
- Consente tagli più sottili anche su superfici di grande spessore.
- Non produce inquinamento o gas a effetto serra.

Una cortadora por chorro de agua es una herramienta capaz de cortar porcelánico u otros materiales usando un chorro de una mezcla de agua y una sustancia abrasiva a alta velocidad y presión. El proceso es esencialmente el mismo que la erosión del agua produce en la naturaleza pero acelerado y concentrado en órdenes de magnitud. Las cortadoras por chorro de agua son capaces de producir intrincados cortes en el porcelánico, de otra forma imposibles de conseguir.

Las ventajas de este proceso van más allá de las meramente estéticas:

- El corte es de mejor calidad, ya que no produce desgarros ni deformaciones por esfuerzos de corte o aportación de calor.
- Permite cortes de mayor espesor y menor ancho de malla.
- No produce gases ni polución.



BAYSTONE BOUTIQUE HOTEL & SPA
Grand Baie. MAURITIUS
Arch: ALBERT ANGEL

PACKING LIST. LISTA D'IMBALLO. LISTA DE EMBALAJE

				BOXES / EUROPALLET CASSE / EUROPALLET CAJAS / EUROPALLET	PIECES / BOX PEZZI / CASSA PIEZAS / CAJA	M ² / BOX M ² / CASSA M ² / CAJA	SQUARE FEET / BOX PIEDI QUADRI / CASSA PIES CUADRADOS / CAJA	M ² / EUROPALLET M ² / EUROPALLET M ² / EUROPALLET	SQUARE FEET / EUROPALLET PIE QUADRATI / EUROPALLET PIES CUADRADOS / EUROPALLET	KG / EUROPALLET KG / EUROPALLET KG / EUROPALLET	KG / BOX KG / CASSA KG / CAJA	L MTS / BOX METRI LINEARI / CASSA METROS LINEALES / CAJA
	base 30x30	29,75x29,75 cm	11.71"x11.71"	40	13	1,150	12,38	46,00	495,14	1030	25,170	-
	base 60x120	59,55x119,3 cm	23.45"x35.22"	50	1	0,710	7,64	35,50	382,12	965	18,840	-
	base 60x120 slim	59,55x119,3 cm	23.45"x35.22"	30	2	1,421	15,29	46,63	501,92	530	16,9	-
	base 30x120	29,75x119,3 cm	11.71"x35.22"	36	3	1,064	11,41	38,16	410,75	1027	27,885	-
	base 20x120	19,71x119,3 cm	7.76"x35.22"	45	4	0,941	10,13	42,35	455,86	1167	25,410	-
	base 15x120	14,74x119,3 cm	5.80"x35.22"	30	6	1,055	11,30	31,50	339,05	840	27,230	-
	base 90x90	89,46x89,46 cm	35.22"x35.22"	36	1	0,800	8,61	28,80	310,00	812	21,910	-
	base 90x90 slim	89,46x89,46 cm	35.22"x35.22"	20	2	1,601	17,22	32,02	620,00	585	27,597	-
	base 45x90	44,63x89,46 cm	17.57"x35.22"	27	3	1,198	12,89	32,53	350,15	880	30,259	-
	base 45x90 slim	44,63x89,46 cm	17.57"x35.22"	27	5	1,996	21,48	53,89	580,06	980	35,455	-
	base 30x90 slim	29,75x89,46 cm	11.71"x35.22"	40	8	2,129	22,91	85,16	916,65	1150	28,170	-
	base 30x90 slim	29,75x89,46 cm	11.71"x35.22"	40	7	1,863	20,05	74,52	802,13	1000	24,430	-
	base rihe 30x90	29,75x89,46 cm	11.71"x35.22"	36	4	1,065	11,46	42,60	458,57	901	21,950	-
	base 22,5x90	22,21x89,46 cm	8.75"x35.22"	36	5	0,993	10,69	35,75	384,81	940	25,470	-
	base up	22,21x88,50 cm	8.75"x34.87"	36	3	0,596	6,41	21,46	230,99	276	7,040	-
	base 15x90	14,74x89,46 cm	5.80"x35.22"	44	8	1,052	12,45	46,29	498,17	1163	25,900	-
	base 15x90	14,74x89,46 cm	5.80"x35.22"	42	7	0,923	9,94	38,77	417,27	1012	23,560	-
	base 15x90 slim	14,74x89,46 cm	5.80"x35.22"	26	6	0,789	8,49	20,51	220,76	522	19,42	-
	base up	14,74x88,80 cm	5.80"x34.96"	30	5	0,655	7,05	19,65	211,51	530	16,890	-
	Legno preincision irreg.	14,74x89,46 cm	5.80"x35.22"	42	7	0,923	9,94	38,77	417,27	1017	23,670	-
	base hexagonal	51,57x59,55 cm	20.31"x23.45"	30	3	0,921	9,87	27,63	297,45	710	22,900	-
	base 60x60	59,55x59,55 cm	23.45"x23.45"	30	3	1,063	11,45	31,89	343,26	780	25,233	-
	base 60x60 slim	59,55x59,55 cm	23.45"x23.45"	30	5	1,773	19,08	53,19	572,53	950	30,898	-
	base 30x60	29,75x59,55 cm	11.71"x23.45"	40	6	1,063	11,44	42,52	457,68	1050	25,667	-
	base 30x60 slim	29,75x59,55 cm	11.71"x23.45"	40	8	1,417	15,25	56,68	610,09	1000	24,427	-
	base pulido	29,75x59,55 cm	11.71"x23.45"	40	7	1,240	13,34	49,60	533,89	1050	25,677	-
	base satinado	29,75x59,55 cm	11.71"x23.45"	40	7	1,240	13,34	49,60	533,89	1100	26,923	-
	base righe	29,75x59,55 cm	11.71"x23.45"	40	6	1,063	11,44	42,52	457,68	1000	24,423	-
	base artech	29,75x59,55 cm	11.71"x23.45"	40	6	1,063	11,44	42,52	457,68	1000	24,423	-
	base eye	29,75x59,55 cm	11.71"x23.45"	16	4	0,709	7,63	11,34	122,11	331	19,267	-
	base 45x45	44,63x44,63 cm	17.57"x17.57"	68	5	0,996	10,72	67,73	729,02	1570	22,750	-
	preincision 7,5x90	22,21x89,46 cm	8.75"x35.22"	36	5	0,993	10,69	35,75	384,81	940	25,470	-
	preincision 2,5x60	29,75x59,55 cm	11.71"x23.45"	16	7	1,240	13,35	19,84	213,56	453	26,867	-
	preincision 3,5x60	29,75x59,55 cm	11.71"x23.45"	16	7	1,240	13,35	19,84	213,56	453	26,867	-
	preincision 7,5x60	29,75x59,55 cm	11.71"x23.45"	16	7	1,240	13,35	19,84	213,56	453	26,870	-
	preincision 15x60	29,75x59,55 cm	11.71"x23.45"	16	7	1,240	13,35	19,84	213,56	453	26,870	-
	preincision irregular	29,75x59,55 cm	11.71"x23.45"	16	7	1,240	13,35	19,84	213,56	453	26,870	-
	b-insert	29,75x59,55 cm	11.71"x23.45"	40	7	1,260	13,57	50,40	542,51	1161	28,449	-
	módulo	29,75x59,55 cm	11.71"x23.45"	16	6	1,063	11,44	17,01	183,07	414	24,423	-
	corte	29,75x59,55 cm	11.71"x23.45"	16	6	1,063	11,44	17,01	183,07	414	24,423	-
	corte	29,75x29,75 cm	11.71"x11.71"	36	7	0,620	6,67	22,32	240,25	528	14,037	-
	raised	44,63x44,63 cm	17.57"x17.57"	17	3	0,598	6,44	10,16	109,36	312	17,013	-
	mosaico hex 3D	27,20x23,60 cm	10.71"x9.29"	32	5	0,320	3,45	10,24	110,23	271	8,019	-
	mosaico 1,5x30	29,75x29,75 cm	11.71"x11.71"	36	7	0,620	6,67	22,32	240,25	474	12,520	-
	mosaico 10x10 slim	29,75x29,75 cm	11.71"x11.71"	36	12	1,062	11,43	38,23	411,50	491	13,010	-
	mosaico 2,5x2,5	29,75x29,75 cm	11.71"x11.71"	36	7	0,620	6,67	22,32	240,25	486	12,854	-
	mosaico 2,5x2,5 slim	29,75x29,75 cm	11.71"x11.71"	36	12	1,062	11,43	38,23	411,50	491	13,010	-
	mosaico 2,5x10	29,75x29,75 cm	11.71"x11.71"	36	7	0,620	6,67	22,32	240,25	486	12,854	-
	mosaico 2,5x30	29,75x29,75 cm	11.71"x11.71"	36	7	0,620	6,67	22,32	240,25	486	12,854	-
	mosaico 3,5x3,5	29,75x29,75 cm	11.71"x11.71"	36	7	0,620	6,67	22,32	240,25	486	13,854	-
	mosaico 3,5x10	29,75x29,75 cm	11.71"x11.71"	36	7	0,620	6,67	22,32	240,25	486	12,854	-
	mosaico 3,5x3,5 3D	29,75x29,75 cm	11.71"x11.71"	36	5	0,443	4,77	15,95	171,68	348	9,273	-
	mosaico 3,5x15	29,75x29,75 cm	11.71"x11.71"	36	7	0,620	6,67	22,32	240,25	486	12,854	-
	mosaico 5x5	29,75x29,75 cm	11.71"x11.71"	36	7	0,620	6,67	22,32	240,25	491	13,000	-
	mosaico 5x5 slim	29,75x29,75 cm	11.71"x11.71"	36	7	0,620	6,67	22,32	240,25	491	13,000	-
	mosaico 5x10	29,75x29,75 cm	11.71"x11.71"	36	10	0,885	9,52	31,86	342,93	868	18,415	-

PACKING LIST. LISTA D'IMBALLO. LISTA DE EMBALAJE

				BOXES / EUROPALLET CASSE / EUROPALLET CAJAS / EUROPALLET	PIECES / BOX PEZZI / CASSA PIEZAS / CAJA	M ² / BOX M ² / CASSA M ² / CAJA	SQUARE FEET / BOX PIEDI QUADRI / CASSA PIES CUADRADOS / CAJA	M ² / EUROPALLET M ² / EUROPALLET M ² / EUROPALLET	SQUARE FEET / EUROPALLET PIE QUADRATI / EUROPALLET PIES CUADRADOS / EUROPALLET	KG / EUROPALLET KG / EUROPALLET KG / EUROPALLET	KG / BOX KG / CASSA KG / CAJA	L MTS / BOX METRI LINEARI / CASSA METROS LINEALES / CAJA
	mosaico 7,5x7,5	29,75x29,75 cm	11.71"x11.71"	36	7	0,620	6,67	22,32	240,25	491	13,000	-
	modulo 15x15	29,75x29,75 cm	11.71"x11.71"	36	6	0,531	5,71	19,12	205,76	423,06	11,120	-
	muretto roots	29,75x59,55 cm	11.71"x23.45"	36	4	0,709	7,63	25,52	274,69	577,49	15,410	-
	mosaico 3D hex slim	29,75x29,75 cm	11.71"x11.71"	36	12	1,060	11,41	38,16	410,75	461,08	12,170	-
	mosaico 3D	28,5x28,5 cm	11.22"x11.22"	36	7	0,569	6,12	20,48	220,48	382,00	9,962	-
	mosaico 3D slim	44,63x44,63 cm	17.57"x17.57"	17	4	0,79	8,50	13,43	144,56	232,91	12,361	-
	decor	29,75x29,75 cm	11.71"x11.71"	36	7	0,620	6,67	22,32	240,25	528	14,037	-
	multicolor	29,75x29,75 cm	11.71"x11.71"	36	7	0,620	6,67	22,32	240,25	528	14,037	-
	mosaico sin fin	29,75x37,50 cm	11.71"x14.76"	32	7	0,620	5,59	16,61	178,80	472	14,037	-
	mosaico sin fin	33x33 cm	12.99"x12.99"	32	7	0,519	7,05	20,89	224,94	359	10,505	-
	muretto	14,87x29,75 cm	5.85"x11.71"	32	12	0,653	7,05	20,89	224,94	359	10,505	-
	muretto	14,87x29,75 cm	5.85"x11.71"	32	14	0,604	6,47	19,33	208,10	414	12,225	-
	muretto slim	14,87x29,75 cm	5.85"x11.71"	32	14	0,604	6,47	19,33	208,10	208	5,785	11,70
	listelo	7,3x89,46 cm	2.87"x35.22"	30	13	0,840	9,04	25,20	208,10	666	21,438	11,28
	listelo	7,3x59,55 cm	2.87"x23.45"	24	18	0,810	8,72	19,44	271,25	452	17,890	11,70
	listelo	4,8x59,55 cm	1.87"x23.45"	24	28	0,840	9,04	20,16	209,25	600	24,050	14,73
	listelo	3,5x59,55 cm	1.38"x23.45"	24	36	0,707	7,64	16,97	217,03	435	17,170	33,35
	listelo	2,3x59,55 cm	0.91"x23.45"	24	56	0,834	9,01	20,02	182,69	459	18,170	6,57
	listelo	7,3x44,63 cm	2.87"x17.57"	48	14	0,472	5,10	22,66	215,52	518	10,320	8,87
	listelo	7,3x29,75 cm	2.87"x11.71"	36	29	0,653	6,97	23,51	243,90	669	17,947	8,86
	listelo sin fin	29,75x37,50 cm	11.71"x14.76"	32	7	0,780	8,41	24,99	252,60	435	12,870	-
	inserto	R 12,8 cm	R 5"	36	14	0,720	7,76	25,92	269,01	316	8,150	-
	taco	14,8x14,8 cm	5.80"x5.80"	36	34	0,750	8,02	26,82	279,02	612	16,350	-
	taco	7,3x7,3 cm	2.87"x2.87"	144	30	0,169	1,82	18,25	288,69	562	3,740	-
	taco	2,3x2,3 cm	0.91"x0.91"	108	270	0,169	1,82	18,25	252,65	417	3,650	5,20
	chevron	14,8x89,46 cm	5.80"x35.22"	36	10	1,089	11,72	39,204	421,98	730	19,650	-
	cenefa-3 90	14,8x89,46 cm	5.80"x35.22"	26	6	0,790	8,54	20,54	196,44	530	19,500	-
	cenefa	4,3x89,46 cm	1.69"x35.22"	44	24	0,923	9,98	40,61	221,09	790	17,430	5,36
	cenefa-3	14,8x59,55 cm	5.80"x23.45"	24	9	0,810	8,72	19,44	437,12	450	17,800	17,50
	cenefa-1	9,6x59,55 cm	3.84"x23.45"	24	14	0,840	9,04	20,16	209,25	466	18,450	5,06
	cenefa	14,8x29,75 cm	5.80"x11.71"	36	17	0,750	8,06	26,96	217,02	621	16,599	12,50
	arbois cenefa	4,75x29,75 cm	1.87"x11.71"	36	42	0,630	6,73	22,50	290,24	505	13,400	11,28
	rodapié	7,3x59,55 cm	2.83"x23.45"	24	18	0,810	8,72	19,44	242,19	452	17,890	6,57
	rodapié	7,3x44,63 cm	2.83"x17.57"	48	14	0,472	5,10	22,66	209,25	506	10,068	6,05
	rodapié	7,3x44,63 cm	2.83"x17.57"	48	13	0,435	4,70	20,88	243,90	484	9,595	8,87
	rodapié	7,3x29,75 cm	2.83"x11.71"	36	29	0,653	6,97	23,51	224,74	669	17,947	8,86
	peldaño simp 30x120	29,75x119,3 cm	11.71"x46.97"	-	2	-	-	-	-	-	18,685	-
	peldaño grad 30x120	29,75x119,3 cm	11.71"x46.97"	-	1	-	-	-	-	-	9,485	-
	peldaño simp 90x90 / grad 90x90	89,46x89,46 cm	46.97"x46.97"	35	1	0,800	8,61	28,00	301,40	776	21,800	-
	peldaño simp 45x90	44,63x89,46 cm	17.57"x35.22"	27	3	1,198	12,89	32,53	253,01	840	30,259	-
	peldaño grad 45x90	44,63x89,46 cm	17.57"x35.22"	27	2	0,799	8,59	21,57	350,15	570	20,256	-
	peldaño grad 33x90	32,45x89,46 cm	12.77"x35.22"	-	2	0,581	6,25	-	233,43	-	16,810	-
	peldaño / peldaño ang	59,55x59,55 cm	23.45"x23.45"	30	3	1,063	11,44	31,89	343,27	756,99	25,233	-
	peldaño grad / grad ang	59,55x59,55 cm	23.45"x23.45"	30	2	0,354	3,81	10,62	343,27	281	8,591	-
	peldaño / peldaño ang	29,75x59,55 cm	11.71"x23.45"	16	7	1,240	13,35	19,84	114,64	478	28,449	-
	peldaño grad / grad ang	29,75x59,55 cm	11.71"x23.45"	16	2	0,360	3,88	5,76	213,56	133,1	8,319	-
	peldaño	44,63x44,63 cm	17.57"x17.57"	-	5	0,996	10,75	-	62,00	-	22,750	-
	peldaño ang	44,63x44,63 cm	17.57"x17.57"	-	5	0,996	10,75	-	-	-	22,750	-
	peldaño grad	44,63x44,63 cm	17.57"x17.57"	-	2	0,360	3,89	-	-	-	9,259	-
	peldaño grad ang	44,63x44,63 cm	17.57"x17.57"	-	2	0,360	3,89	-	-	-	9,259	-
	byte lista 90	2x89,46 cm	0.79"x35.22"	-	18	0,322	3,45	-	-	324	10,030	12,56
	fusion graffiato lista 90	1,5x89,46 cm	0.59"x35.22"	-	80	1,074	11,56	-	-	1146	56,130	71,57
	pod / byte lista 60	1,5x59,55 cm	0.59"x23.45"	132	36	0,322	3,49	42,50	457,51	1079	8,000	21,57
	fusion natural lista 60	1,5x59,55 cm	0.39"x23.45"	132	250	1,500	16,27	198,00	457,51	1949	14,593	100,50
	fusion graffiato lista 60	1,5x59,55 cm	0.59"x23.45"	96	200	1,790	19,24	171,55	2131,46	1376	14,093	119,10
	corner 60	1,5x59,55 cm	0.59"x23.45"	-	14	0,125	1,34	-	1846,57	-	3,160	-
	corner 30	1,5x29,75 cm	0.59"x11.71"	-	30	0,134	1,44	-	-	-	3,440	-



Industrial zone. Zona industriale. Zona industrial:

1.000.000 m²

Production plant. Stabilimenti di produzione. Planta de producción:

250.000 m²

Production capacity. Capacità produttiva. Capacidad de producción:

5.500.000 m²/year

SYMBOLS



Porcelain
Porcelánico
Porcelanatto



White Body
Pasta Blanca
Pasta Bianca



Double firing
Bicocción
Bicottura



Natural
Naturale



Lappato
Lappato
Lappato



Structured
Estrutturado
Strutturato



Polished
Pulido
Levigato



Satin
Satinado
Satinato



Shiny
Brillo
Lucido



Matt
Mate
Satinato



Destonified
Destonificado
Stonalizzato



Non slip
Antideslizante
Antiscivolo



Glass
Cristal
Cristallo



Metal
Metal
Metallo

www.landporcelanico.com

Ctra. Castellón-San Juan de Moró km. 12,5 12130 San Juan de Moró. Castellón. Spain.
T: +34 964 70 10 15 | E: land@landporcelanico.com



PLEASE RECYCLE WHEN OBSOLETE
PER FAVORE RICICLARLO QUANDO VECCHIO
POR FAVOR RECICLAR CUANDO QUEDE OBSOLETO
WENN NICHT MEHR AKTUELL, RECYCLN
S'IL VOUS PLAÎT, MERCI DE RECYCLER



Land Porcelanico App

