

lAnd

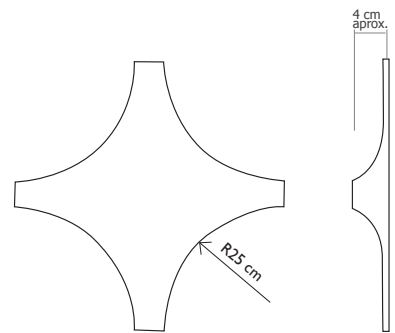

3Dimensional
techporcelain



STAR
59,55X58,88 cm

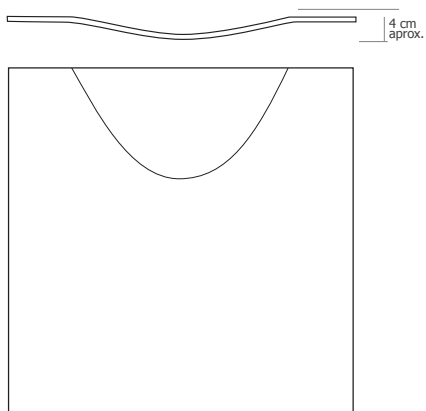

BAG
89,46 X 89,46 cm / 59,55x59,55 cm

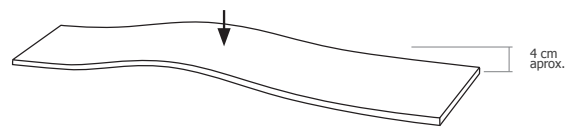

UP
14,74x118,80 cm

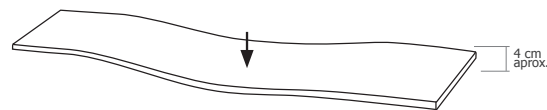

DOWN
14,74x118,80 cm

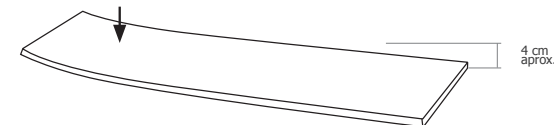

SIDE UP
14,74x118,80 cm

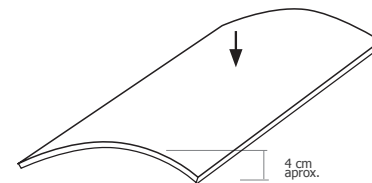

VEXA
44,10 X 89,46 cm

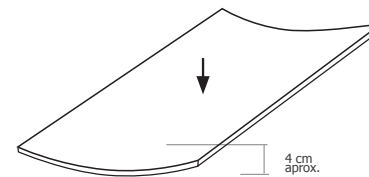

CAVE
43,55 X 89,46 cm



UP / DOWN

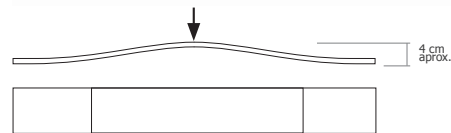

UP
14,74x118,80 cm

- Matter Up 14,73x118,80 cm
- Roots Up 19,71x118,8 cm
- Fahrenheit Up 22,21x88,80 cm

G-5435

G-5435
G-5355

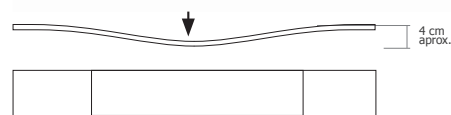

DOWN
14,74x118,80 cm

- Matter Down 14,73x118,80 cm

G-5435

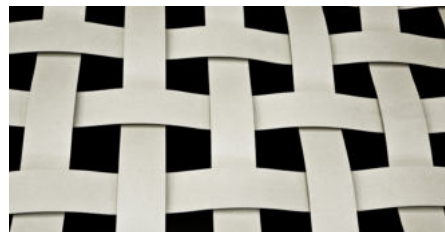

	% (m2)	pieces/m2	pieces/box
UP	100%	5,68	3
Not Covered Area	25%		



	% (m2)	pieces/m2	pieces/box
UP	100%	5,10	3
Not Covered Area	0%		

This is a natural product made through a handmade process, therefore, its possible shade or size variations must be considered as typical features of the material and they will not be admitted in a claim.
Este es un producto natural fabricado artesanalmente, por lo que posibles variaciones de tono o dimension deben considerarse propias del material y no será objeto de reclamación.



3Ddimensional

Azulcascais ivory slim up 22,21x89,46 cm

*Consultar con la red comercial para la realización de estas piezas con otras colecciones.



3Dimensional

Fahrenheit oxide up 22,21x88,80 cm

PRIVATE HOUSE. Ourense. SPAIN



LAND SHOWROOM.

Matter ivory up - Matter ivory down
14,73x118,80 cm / 29,67x118,80



SHOWROOM
Dortmund, Germany

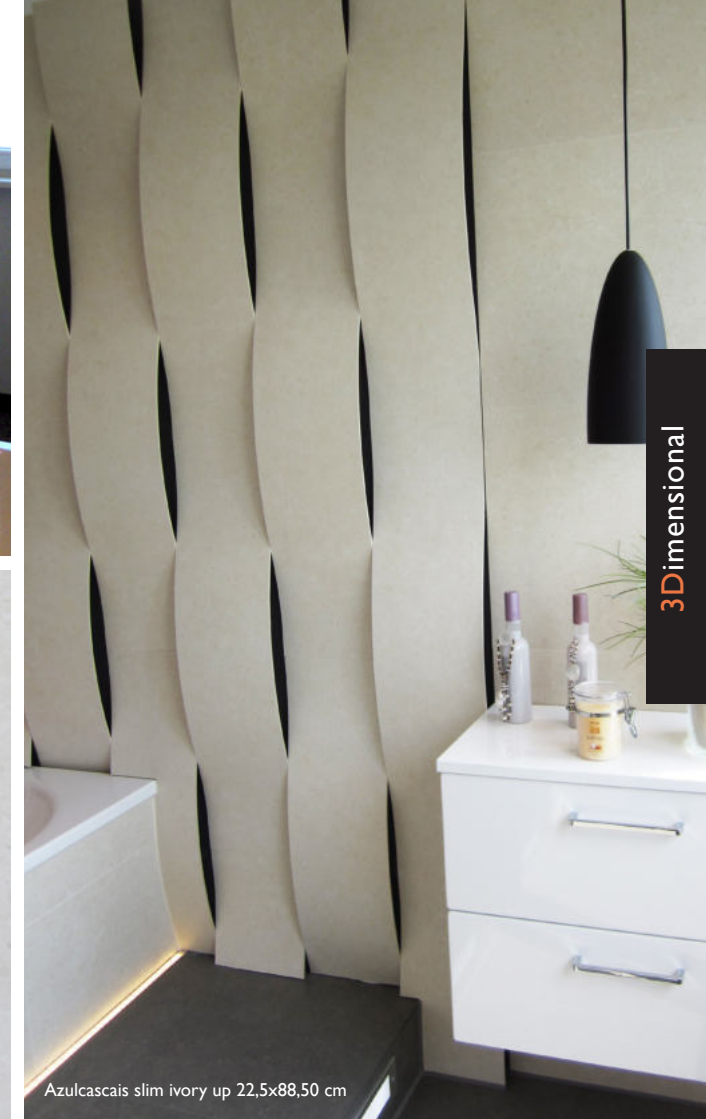

Azulcascais slim ivory up 22,5x88,50 cm

3Ddimensional

BAG



4 cm
aprox.

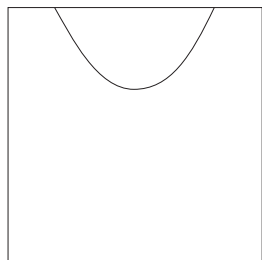

BAG

89,46 X 89,46 cm / 59,55x59,55 cm

- Portland Bag 89,46x89,46 cm
- Portland Bag 59,55x59,55 cm

G-5795
G-5449

* available in all colors from Portland collection.
disponible en todos los colores de la colección Portland.

TILING PROPOSALS. PROPUESTAS DE COLOCACIÓN

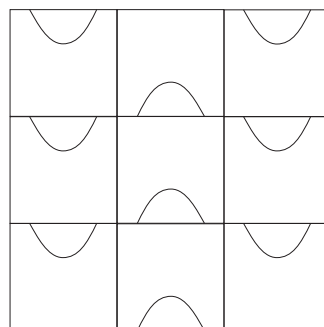
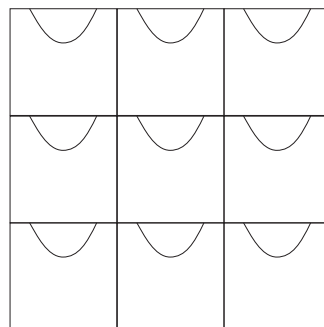

This is a natural product made through a handmade process, therefore, its possible shade or size variations must be considered as typical features of the material and they will not be admitted in a claim.
Este es un producto natural fabricado artesanalmente, por lo que posibles variaciones de tono o dimension deben considerarse propias del material y no será objeto de reclamación.

CAVE

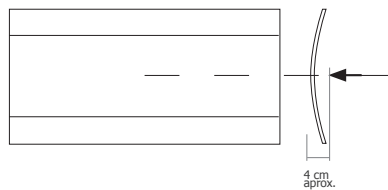

CAVE
43,55 X 89,46 cm
- Fahrenheit Cave 43,55x89,46 cm G-5599

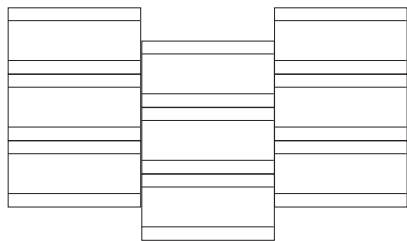

VEXA

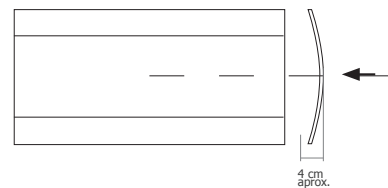

VEXA
44,10 X 89,46 cm
- Fahrenheit Vexa 44,10x89,46 cm G-5599

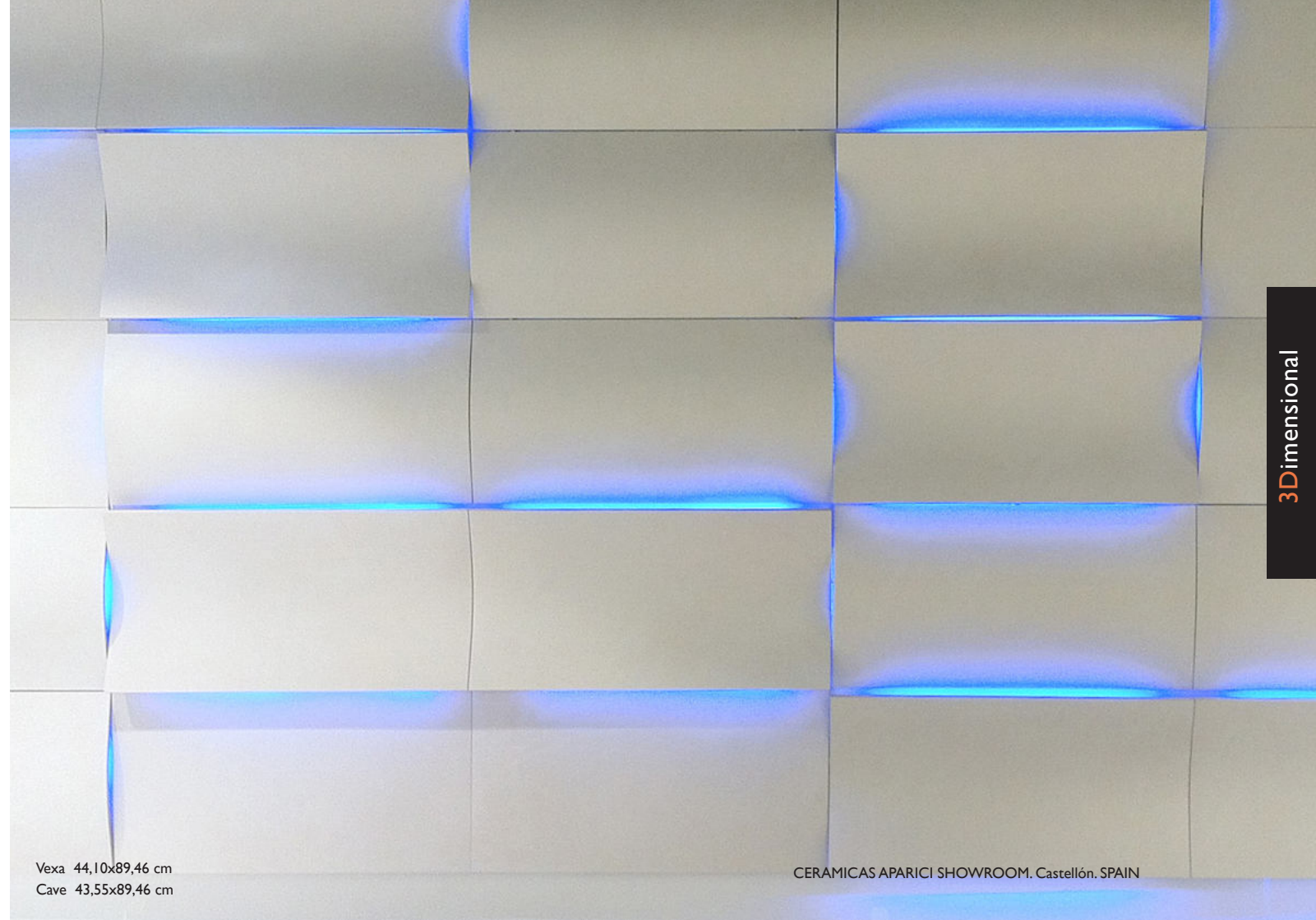
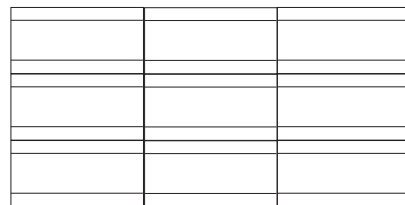

Vexa 44,10x89,46 cm
Cave 43,55x89,46 cm

CERAMICAS APARICI SHOWROOM. Castellón. SPAIN

3Dimensional

This is a natural product made through a handmade process, therefore, its possible shade or size variations must be considered as typical features of the material and they will not be admitted in a claim. Este es un producto natural fabricado artesanalmente, por lo que posibles variaciones de tono o dimension deben considerarse propias del material y no será objeto de reclamación.

*Consultar con la red comercial para la realización de estas piezas con otras colecciones.

STAR

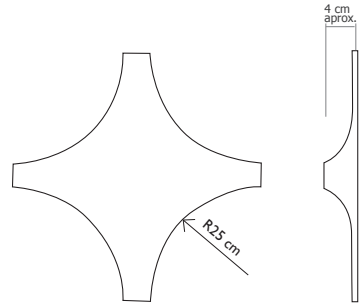

STAR

59,55x58,88 cm - 23.45"x 23.18"

- Matter Star 59,55x58,88 cm

G-5499

This is a natural product made through a handmade process, therefore, its possible shade or size variations must be considered as typical features of the material and they will not be admitted in a claim.
Este es un producto natural fabricado artesanalmente, por lo que posibles variaciones de tono o dimension deben considerarse propias del material y no será objeto de reclamación.

*Consultar con la red comercial para la realización de estas piezas con otras colecciones.

TILING PROPOSALS.
PROPUESTAS DE COLOCACIÓN

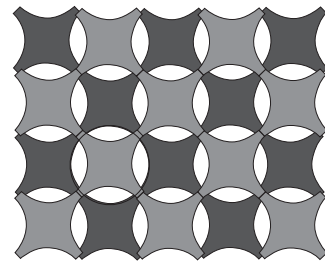
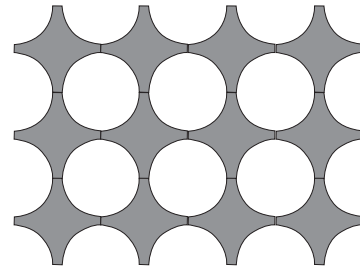
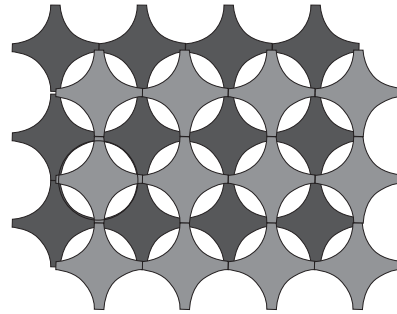

3Ddimensional

Matter ivory natural star 59,55x58,88 cm