

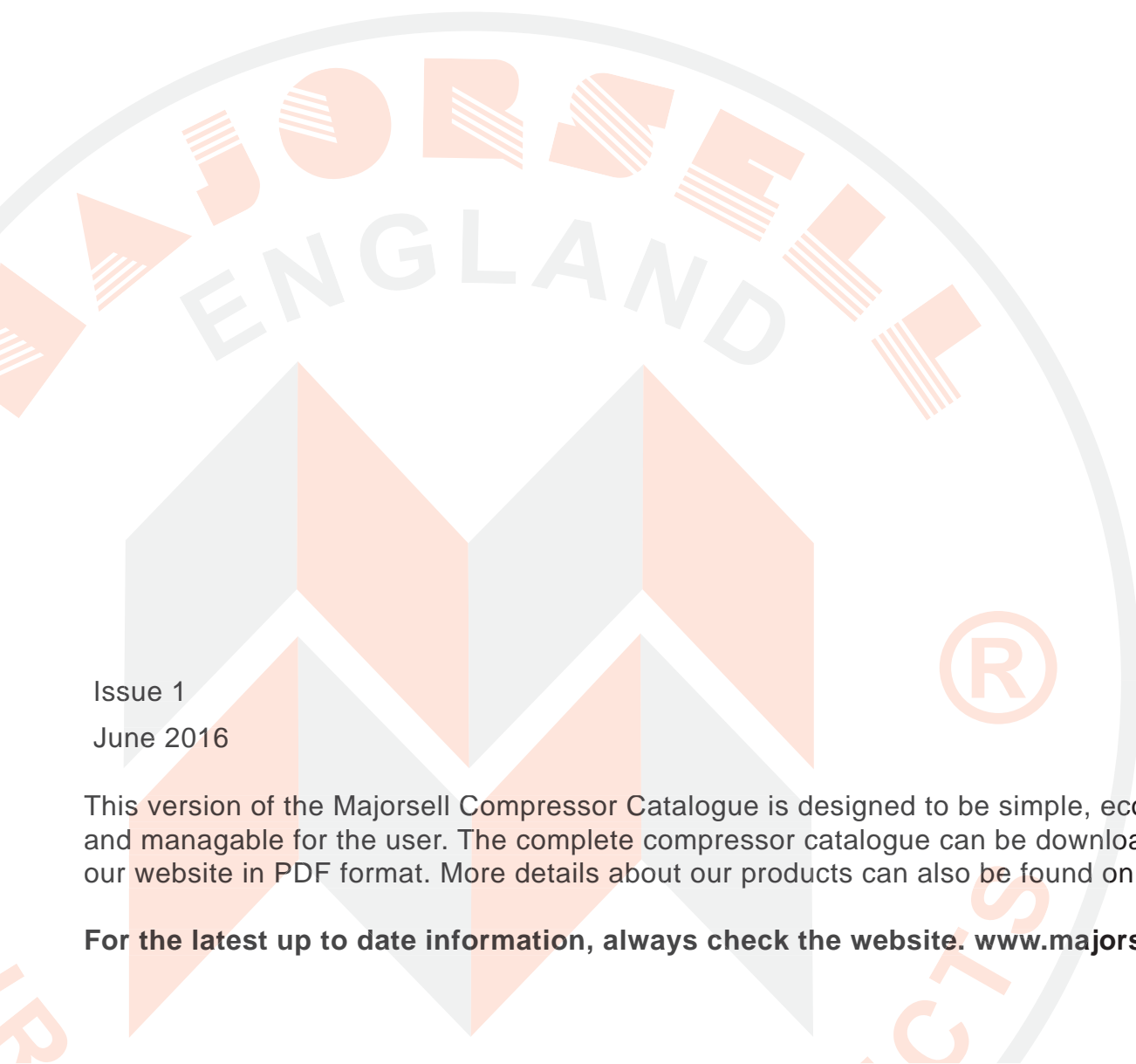

**MAJORSELL®**

# Compressor Catalogue for BENDIX, CUMMINS and MIDLAND applications





Issue 1  
June 2016

This version of the Majorsell Compressor Catalogue is designed to be simple, economical, and manageable for the user. The complete compressor catalogue can be downloaded from our website in PDF format. More details about our products can also be found on our website.

**For the latest up to date information, always check the website. [www.majorsell.co.uk](http://www.majorsell.co.uk)**

Majorsell Limited was established in 1980 as a reconditioning workshop of air brake equipment for commercial vehicles and off-road equipment, specialising in the repair of spring brakes and brake valves. As quality parts were hard to obtain, the decision was made to introduce a range of Majorsell air brake parts, primarily for use in its own workshop. This then became the start of the kit programme for which Majorsell is now internationally renowned. The range of kits offered has now evolved from just brake valves to air dryers, clutch servos, calipers and of course compressors.

The range of Majorsell compressor repair kits and components has increased continually during the last 30 years and is now probably the most extensive range of aftermarket compressor parts offered by a single company in the world. All of our compressor kits are designed with the rebuilder in mind to offer high quality and maximum choice whilst keeping costs to a minimum. They are all built in our UK warehouse to our specification and all of our compressor parts are used in our own reconditioning workshop.

In early 2011 we moved to a much larger facility in West Bromwich and invested a substantial amount in new machinery for our workshop, including a brand new test machine. In 2012 another building was purchased to accommodate the increase in demand for our reconditioned compressors and in 2014 an expansion to our existing workshop was completed.

Majorsell has been exporting since 1986 and now exports to over 70 countries. Our customers include small workshops and rebuilders as well as fleet operators and large distributors. We pride ourselves on our customer service and attention to detail. All of our parts are carefully packed and are easily identifiable in our distinctive Majorsell packaging. Majorsell is an internationally recognised brand which is something we are very proud of.

All Majorsell parts are alternative to OE and are replacements to those of all the leading makes of air brake and truck manufacturers. Over the years we have developed a large database of cross references and technical information, all of which is available on our website. To avoid confusion with any other manufacturer we have our own unique part numbering system.

In addition to air brake parts we also offer a comprehensive range of caliper parts and air conditioning compressors as well as ancillary items and workshop consumables. We are also pleased to be official stockists of Wabco, Cummins, Raufoss, Fleetguard and Valvoline.

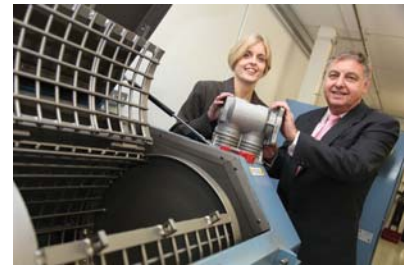

**Tel: ++44 (0) 121 544 0951**  
**e-mail: [sales@majorsell.co.uk](mailto:sales@majorsell.co.uk)**  
**[www.majorsell.co.uk](http://www.majorsell.co.uk)**



# TABLE OF CONTENTS

## BENDIX

065049	8	285970	23	KZ642	38
065197	8	286017	23	KZ800	38
065198	9	286104	24	KZ801	39
065300	9	286538	24	KZ803	39
101648	10	286539	25	KZ996	40
101649	10	286550	25	KZ1087	40
101650	11	286552	26	KZ1115-2	41
101651	11	286578	26	KZ1114	41
104437	12	286584	27	KZ1143	42
107007	12	287631	27	KZ1265-2	42
107506	13	289257	28		
107507	13	1186616	28		
107783	14	1189106	29		
107981	14	1189140	29		
108226	15	1189385	30		
109072	15	1189495	30		
109250	16	1189497	31		
109864	16	1189498	31		
227331	17	1189499	32		
229990	17	1194125	32		
271721	18	1194190	33		
274838	18	1194212	33		
274935	19	1194215	34		
276961	19	1194233	34		
277057	20	1194410	35		
280737	20	1194430	35		
282397	21	1194456	36		
282404	21	5001869	36		
285923	22	5012532	37		
285924	22	KZ433	37		

## CUMMINS

3035673	44
3047440	44
3048672	45
3048673	45
3048675	46
3048677	46
3048680	47
3049186	47
3558006	48
3558013	48
3558059	49
3558072	49
3558097	50
3558098	50
3558113	51
3558182	51
3558211	52
3558212	52

## MIDLAND

KN7070	54
KN13040	54
KN13050	55
KN13220	55
KN16020	56

## REPAIR KITS

A66RK058	58
A68RK006	58
A68RK007	59
A68RK009	59
A68RK038	60
A68RK040	60
A68RK056	61
A68RK058	61
A68RK092	62
A68RK094	62
A68RK096	63
A68RK103	63
A68RK104	64
A68RK105	64
A68RK109	65
A68RK115	65
A68RK117	66
A68RK118	66
A68RK124	67
A69RK021	67
A73RK001	68
A73RK014	68
A73RK015	68
A74RK001	69
A74RK010	69
A74RK002	69
A74RK012	69
A74RK016	70
A74RK017	70
220007	71

## REPAIR KITS

B68RK003	71
220020	71



BENDIX

BENDIX

BENDIX

BENDIX

BENDIX

BENDIX

BENDIX

BENDIX

BENDIX

BENDIX

KNORR

BENDIX

BENDIX

BENDIX

BENDIX

BENDIX

BENDIX

BENDIX

BENDIX

BENDIX

BENDIX

BENDIX

BENDIX

BENDIX

BENDIX

BENDIX

BENDIX

Parts suitable for

# BENDIX

## Compressors

BENDIX

BENDIX

BENDIX

BENDIX

BENDIX

BENDIX

BENDIX

BENDIX

BENDIX

BENDIX

BENDIX

BENDIX

BENDIX

BENDIX

BENDIX

BENDIX

BENDIX

BENDIX

BENDIX

BENDIX

BENDIX

BENDIX

BENDIX

BENDIX

BENDIX

BENDIX

BENDIX

BENDIX

BENDIX

BENDIX

BENDIX

BENDIX

BENDIX

**MAJORSELL PARTS FOR: 065049**

**MAJORSELL REBUILD: 68A144R**



Users:									
OE:	BX2150								
Bore	Drive	Cooling	Weight	Mount	Lube	Water Port	Air inlet	Air delivery	
85.7 mm	Non-through	Water	19 Kg	Base	Engine oil	½"	Manifold	½"	

Repair Kits	Full Kit	Head Kit	Gasket Kit	Valve Kit	Valve Plate	Cooling Plate		
	A68RK009	A68RK009A						
Piston	Std	0.25 mm	0.50 mm	0.75 mm	1.00 mm			
	020084	020085	020086	020087				
Rings	A68RK087	A68RK088	A68RK089	A68RK090				
Head								
Crankshaft		140185 (Nut)						
Front end Cover								
Rear end Cover								
Conn Rod								
Bolts	140173 (4)	140157 (4)	140159 (4)					
Other Parts	Front bush	Rear Bearing	Thrust Washer	O Ring	Locking Tab	Front Oil Seal		
	050202	6307	050108	BS040	050008 (2)	110008		

**MAJORSELL PARTS FOR: 065197**

**MAJORSELL REBUILD: 68A093R**



Users:	VOLVO	NAVISTAR							
OE:	70001-8001	1672563-C91	107000	107974	107975	108583	109197	107506	
Bore	Drive	Cooling	Weight	Mount	Lube	Water Port	Air inlet	Air delivery	
2.78"	Through	Water	26 kg	Flange	Engine oil	½"	Manifold	Manifold	

Repair Kits	Major Head Kit	Minor Head Kit	Gasket Kit	Valve Kit	Valve Plate	Cooling Plate	Ess Kit	
	A68RK096	A68RK096A					A68RK096D	
Piston	Std	+0.010"	+0.020"	+0.030"	+0.040"			
	020106	020107	020108	020109	020110			
Rings	A68RK097	A68RK098	A68RK099	A68RK100	A68RK101			
Head								
Crankshaft								
Front end Cover								
Rear end Cover								
Conn Rod								
Bolts	140163 (6)	140159 (4)	140175 (6)	140164 (6)	140159 (6)			
Other Parts	Front bush	Rear Bearing	Inserts	Inserts	Inserts	Thrust Washer	Locking Tab	Front Gasket
	050064	6011	050171	050172	050173	050114	050083 (2)	010443
	Rear Gasket	O Ring						
	010094	BS241V						



Check our web site for suitability of these and other parts, or contact us directly. Original part numbers are fitted for reference only. Check all applications. All parts offered are Majorsell brand and may not be of an original supply. Majorsell kit content and ring sets may be different to the original.



**MAJORSELL REBUILD:**

**MAJORSELL PARTS FOR: 065198**

Users:	CUMMINS							
OE:								



Bore	Drive	Cooling	Weight	Mount	Lube	Water Port	Air inlet	Air delivery
2.78"	Through	Water	24 Kg	Flange	Engine oil	1/2"	1/2"	1/2"

Repair Kits	Full Kit	Head Kit	Gasket Kit	Valve Kit	Valve Plate	Cooling Plate		
	A68RK096	A68RK096A						
Piston	Std	+0.010"	+0.020"	+0.030"	+0.040"			
	020101	020102	020103	020104	020105			
Rings	A68RK097	A68RK098	A68RK099	A68RK100	A68RK101			
Head								
Crankshaft								
Front end Cover								
Rear end Cover								
Conn Rod								
Bolts								
Other Parts	Flange Gasket							
	010349							

**MAJORSELL REBUILD: 68A004R**

**MAJORSELL PARTS FOR: 065300**

Users:	CUMMINS							
OE:	104103	108401	065055					



Bore	Drive	Cooling	Weight	Mount	Lube	Water Port	Air inlet	Air delivery
85.7mm	Through	Water	21Kg	Flange	Engine oil	1/2"	Manifold	1/2"

Repair Kits	Full Kit	Head Kit	Gasket Kit	Valve Kit	Valve Plate	Cooling Plate		
	A68RK009	A68RK009A						
Piston	Std	0.25 mm	0.50 mm	0.75 mm	1.00 mm			
	020084	020085	020086	020087				
Rings	A68RK087	A68RK088	A68RK089	A68RK090				
Head	220188 (Comp)							
Crankshaft								
Front end Cover								
Rear end Cover								
Conn Rod								
Bolts	140173 (4)	140157 (4)	140156 (4)	140157 (4)	140159 (4)	140157 (4)		
Other Parts	Front bush	Rear Bearing	Thrust Washer	O Ring	Locking Tab			
	050202	6307	050108	BS041	050008 (2)			



Check our web site for suitability of these and other parts, or contact us directly. Original part numbers are fitted for reference only. Check all applications. All parts offered are Majorsell brand and may not be of an original supply. Majorsell kit content and ring sets may be different to the original.

**MAJORSELL PARTS FOR: 101648**

**MAJORSELL REBUILD: 68A099R**



Users:	DETROIT	FORD						
OE:	8921206	289924	E1 HS - 2875BA					
Bore	Drive	Cooling	Weight	Mount	Lube	Water Port	Air inlet	Air delivery
2 3/4"	Non through	Water	18 Kg	Base	Engine oil	1/2"	Manifold	Manifold

Repair Kits	Full Kit	Service Kit	Unloader Kit	Valve Kit	Valve Plate	Cooling Plate		
	A68RK058	A68RK058A	A68RK056A					
Piston	Std	+0.010"	+0.020"	+0.030"	+0.040"			
	020038	020039	020040	020041	020042			
Rings	A68RK019	A68RK020	A68RK021	A68RK022	A68RK023			
Head	220196							
Crankshaft		140185 (Nut)						
Front end Cover								
Rear end Cover								
Conn Rod								
Bolts	140173 (10)	140160 (4)	140157 (4)	140159 (4)	140157 (4)			
Other Parts	Front Bearing	Rear Bush	Inserts	Thrust Washer	Locking Tab	Crankshaft Key	Oil Seal	Valve Seat
	6011	050110	050009 (2)	050114	050083 (2)	090004	110014	060070 (2)
	Valve Cap Nut	O Ring						
	060140 (2)	BS236						

**MAJORSELL PARTS FOR: 101649**

**MAJORSELL REBUILD: 68A120R**



Users:	DETROIT							
OE:								
Bore	Drive	Cooling	Weight	Mount	Lube	Water Port	Air inlet	Air delivery
2 3/4"	Non through	Water	21 Kg	Flange	Engine oil	1/2"	Manifold	Manifold

Repair Kits	Full Kit	Head Kit	Unloader Kit	Valve Kit	Valve Plate	Cooling Plate		
	A68RK058	A68RK058A	A68RK056A					
Piston	Std	+0.010"	+0.020"	+0.030"	+0.040"			
	020038	020039	020040	020041	020042			
Rings	A68RK019	A68RK020	A68RK021	A68RK022	A68RK023			
Head								
Crankshaft		140185 (Nut)						
Front end Cover								
Rear end Cover								
Conn Rod								
Bolts	140173 (10)	140159 (4)	140157 (4)	140190 (6)	140157 (6)			
Other Parts	Front bush	Rear Bush	Inserts	Thrust Washers		Locking Tab	Flange Gasket	Valve Seat
	050103	050109	050009 (2)	050108 (Front)	050114 (Rear)	050083 (2)	010059	060070 (2)
	Valve Cap Nut							
	060140 (2)							



Check our web site for suitability of these and other parts, or contact us directly. Original part numbers are fitted for reference only. Check all applications. All parts offered are Majorsell brand and may not be of an original supply. Majorsell kit content and ring sets may be different to the original.

**MAJORSELL REBUILD: 68A064R**

**MAJORSELL PARTS FOR: 101650**

Users:	DETROIT							
OE:								



Bore	Drive	Cooling	Weight	Mount	Lube	Water Port	Air inlet	Air delivery
2 3/4"	Non through	Water	20 Kg	Flange	Engine oil	1/2"	Manifold	Manifold

Repair Kits	Full Kit	Head Kit	Unloader Kit	Valve Kit	Valve Plate	Cooling Plate		
	A68RK058	A68RK058A	A68RK056A					
Piston	Std	+0.010"	+0.020"	+0.030"	+0.040"			
	020038	020039	020040	020041	020042			
Rings	A68RK019	A68RK020	A68RK021	A68RK022	A68RK023			
Head								
Crankshaft								
Front end Cover								
Rear end Cover								
Conn Rod								
Bolts	140173 (10)	140174 (6)	140175 (6)	140160 (4)	140103 (4)	140161 (5)	140162 (5)	
Other Parts	Front bush	Rear Bush	Inserts	Thrust Washers		Locking Tab	Flange Gasket	Valve Seat
	050103	050109	050009 (2)	050108 (Front)	050114 (Rear)	050083 (2)	010059	060070 (2)
	Valve Cap Nut							
	060140 (2)							

**MAJORSELL REBUILD: 68A087R**

**MAJORSELL PARTS FOR: 101651**

Users:	DETROIT							
OE:	05108209							



Bore	Drive	Cooling	Weight	Mount	Lube	Water Port	Air inlet	Air delivery
2 3/4"	Non through	Water	20 Kg	Flange	Engine oil	1/2"	Manifold	Manifold

Repair Kits	Full Kit	Head Kit	Unloader Kit	Valve Kit	Valve Plate	Cooling Plate		
	A68RK058	A68RK058A	A68RK056A					
Piston	Std	+0.010"	+0.020"	+0.030"	+0.040"			
	020038	020039	020040	020041	020042			
Rings	A68RK019	A68RK020	A68RK021	A68RK022	A68RK023			
Head								
Crankshaft								
Front end Cover								
Rear end Cover								
Conn Rod								
Bolts	140173 (10)	140174 (6)	140175 (6)	140160 (4)	140103 (4)	140161 (5)	140162 (5)	
Other Parts	Front bush	Rear Bush	Inserts	Thrust Washers		Locking Tab	Flange Gasket	Valve Seat
	050103	050109	050009 (2)	050108 (Front)	050114 (Rear)	050083 (2)	010059	060070 (2)
	Valve Cap Nut							
	060140 (2)							



Check our web site for suitability of these and other parts, or contact us directly. Original part numbers are fitted for reference only. Check all applications. All parts offered are Majorsell brand and may not be of an original supply. Majorsell kit content and ring sets may be different to the original.

**MAJORSELL PARTS FOR: 104437**

**MAJORSELL REBUILD: 68A128R**



Users:									
OE:	F8HT2875FA								
Bore	Drive	Cooling	Weight	Mount	Lube	Water Port	Air inlet	Air delivery	
2 3/4"	Through	Water	20 Kg	Base	Engine oil	1/2"	Manifold	Manifold	

Repair Kits	Full Kit	Service Kit	Unloader Kit	Valve Kit	Valve Plate	Cooling Plate		
		A68RK038A	A68RK056A					
Piston	Std	+0.010"	+0.020"	+0.030"	+0.040"			
	020028	020029	020030	020031	020032			
Rings	A68RK051	A68RK052	A68RK053	A68RK054	A68RK055			
Head								
Crankshaft		140185 (Nut)						
Front end Cover								
Rear end Cover								
Conn Rod								
Bolts	140217 (6)	140219 (4)	140218 (4)	140194 (6)				
Other Parts	Front bush	Rear Bearing	Inserts	Thrust Washer	Locking Tab	Crankshaft Key	Sump Gasket	
	050115	6207	050014 (2)	050108	050083 (2)	090004	010092	

**MAJORSELL PARTS FOR: 107007**

**MAJORSELL REBUILD: 68A109R**



Users:	VOLVO							
OE:	065204	107513						
Bore	Drive	Cooling	Weight	Mount	Lube	Water Port	Air inlet	Air delivery
2.78"	Non-through	Water	22 Kg	Flange	Engine oil	1/2"	Manifold	1/2"

Repair Kits	Major Head Kit	Minor Head Kit	Gasket Kit	Valve Kit	Valve Plate	Cooling Plate	Ess Kit	
	A68RK096	A68RK096A					A68RK096D	
Piston	Std	+0.010"	+0.020"	+0.030"	+0.040"			
	020106	020107	020108	020109	020110			
Rings	A68RK097	A68RK098	A68RK099	A68RK100	A68RK101			
Head								
Crankshaft								
Front end Cover								
Rear end Cover								
Conn Rod								
Bolts	140163 (6)	140159 (4)	140157 (4)	140164 (4)	140164 (6)			
Other Parts	Front bush	Rear bush	Inserts	Thrust Washer		O Ring	Inserts	Sump Gasket
	050064	050115	050171 (2)	050114 (Front)	050108 (Rear)	BS241V	050083 (2)	010393
	Flange Gasket	Liner Sleeve						
	010059	020994 (2)						



Check our web site for suitability of these and other parts, or contact us directly. Original part numbers are fitted for reference only. Check all applications. All parts offered are Majorsell brand and may not be of an original supply. Majorsell kit content and ring sets may be different to the original.

**MAJORSELL REBUILD: 68A103R**

**MAJORSELL PARTS FOR: 107506**

Users:	CUMMINS							
OE:	3069211	3074470	3166445	3417958	3609999	109197-065197		



Bore	Drive	Cooling	Weight	Mount	Lube	Water Port	Air inlet	Air delivery
2.78"	Through	Water	22 Kg	Flange	Engine oil	1/2"	Manifold	1/2"

Repair Kits	Major Head Kit	Minor Head Kit	Gasket Kit	Valve Kit	Valve Plate	Cooling Plate	Ess Kit	
	A68RK096	A68RK096A					A68RK096D	
Piston	Std	+0.010"	+0.020"	+0.030"	+0.040"			
	020106	020107	020108	020109	020110			
Rings	A68RK097	A68RK098	A68RK099	A68RK100	A68RK101			
Head								
Crankshaft								
Front end Cover								
Rear end Cover								
Conn Rod								
Bolts	140163 (6)	140159 (4)	140157 (4)	140164 (4)	140164 (6)			
Other Parts	Front bush	Rear bush	Inserts	Thrust Washer	Locking Tab	Flange Gasket		Liner Sleeve
	050064	6011	050171 (2)	050114	050083 (2)	010443 (Front)	010094 (Rear)	020994 (2)

**MAJORSELL REBUILD: 68A151R**

**MAJORSELL PARTS FOR: 107507**

Users:								
OE:								



Bore	Drive	Cooling	Weight	Mount	Lube	Water Port	Air inlet	Air delivery
2.78"	Through	Water	22 kg	Flange	Engine Oil	Water	1/2"	1/2"

Repair Kits	Full Kit	Head Kit	Gasket Kit	Valve Kit	Valve Plate	Cooling Plate	Unloader Kit	
	A68RK096	A68RK096A					A68RK096D	
Piston	Std	0.25 mm	0.50 mm	0.75 mm	1.00 mm			
	020101	020102	020103	020104	020105			
Rings	A68RK097	A68RK098	A68RK099	A68RK100	A68RK101			
Head								
Crankshaft								
Front end Cover								
Rear end Cover								
Conn Rod								
Bolts	140163 (6)	140159 (4)	140157 (4)	140164 (6)				
Other Parts	Front Bush	Rear Bearing	Inserts	Thust Washer	Gasket	Gasket	Gasket	Liner Sleeve
	050064	6011	050171 (2)	050114	010393	010443	010094	020994



Check our web site for suitability of these and other parts, or contact us directly. Original part numbers are fitted for reference only. Check all applications. All parts offered are Majorsell brand and may not be of an original supply. Majorsell kit content and ring sets may be different to the original.

**MAJORSELL PARTS FOR: 107783**

**MAJORSELL REBUILD: 68A043R**



Users:	DETROIT								
OE:	23509780								
Bore	Drive	Cooling	Weight	Mount	Lube	Water Port	Air inlet	Air delivery	
2.78"	Non through	Water	17 Kg	Flange	Engine oil	½"	½"	½"	

Repair Kits	Major Head Kit	Minor Head Kit	Gasket Kit	Valve Kit	Valve Plate	Cooling Plate	Ess Kit	
	A68RK096	A68RK096A					A68RK096D	
Piston	Std	+0.010"	+0.020"	+0.030"	+0.040"			
	020101	020102	020103	020104	020105			
Rings	A68RK097	A68RK098	A68RK099	A68RK100	A68RK101			
Head								
Crankshaft								
Front end Cover								
Rear end Cover								
Conn Rod								
Bolts	140163 (6)	140159 (4)	140157 (4)	140159 (4)	140164 (4)	140164 (6)		
Other Parts	Front bush	Rear bush	Inserts (2)			Thrust Washer		Locking Tab
	050064	050115	050171	050172	050173	050114 (Front)	050108 (Rear)	050083
	Sump Gasket	O Ring	Flange Gasket	Liner Sleeve				
	010393	BS241V	010059	020994				

**MAJORSELL PARTS FOR: 107981**

**MAJORSELL REBUILD: 68A073R**



Users:	CAT								
OE:	4P0596	4P2419	4P3956	CAT3116	CAT3126	6L1670	OR3391	1043823	
	1067851	1067852	1069089	1092996	1259562	1647557	1647558	3093850	8166665
Bore	Drive	Cooling	Weight	Mount	Lube	Water Port	Air inlet	Air delivery	
2.78"	Through	Water	28 Kg	Flange	Engine oil	¾"	½"	½"	

Repair Kits	Major Head Kit	Minor Head Kit	Gasket Kit	Valve Kit	Valve Plate	Cooling Plate	Ess Kit	
	A68RK096	A68RK096A					A68RK096D	
Piston	Std	+0.010"	+0.020"	+0.030"	+0.040"			
	020106	020107	020108	020109	020110			
Rings	A68RK097	A68RK098	A68RK099	A68RK100	A68RK101			
Head								
Crankshaft		140141 (Nut)						
Front end Cover								
Rear end Cover								
Conn Rod								
Bolts	140163 (6)	140159 (4)	140157 (4)	140156 (4)	140164 (5)			
Other Parts	Front bush	Rear Bearing	Inserts (2)			Thrust Washer	Locking Tab	O Ring
	050064	6011	050171	050172	050173	050114	050083 (2)	BS241V
	Sump Gasket	Flange Gasket	Liner Sleeve					
	010393	010059	020994 (2)					



Check our web site for suitability of these and other parts, or contact us directly. Original part numbers are fitted for reference only. Check all applications. All parts offered are Majorsell brand and may not be of an original supply. Majorsell kit content and ring sets may be different to the original.

**MAJORSELL REBUILD: 68A113R**

**MAJORSELL PARTS FOR: 108226**

Users:	CUMMINS							
OE:	3924878							



Bore	Drive	Cooling	Weight	Mount	Lube	Water Port	Air inlet	Air delivery
2.5/8"	Non through	Water	20 Kg	Flange	Engine oil	1/2"	Manifold.	1/2"

Repair Kits	Full Kit	Service Kit	Gasket Kit	Valve Kit	Valve Plate	Cooling Plate	Unloader Kit	
		A68RK038A					A68RK056A	
Piston	Std	+0.010"	+0.020"	+0.030"	+0.040"			
	020028	020029	020030	020031	020032			
Rings	A68RK051	A68RK052	A68RK053	A68RK054	A68RK055			
Head								
Crankshaft		140240 (Nut)						
Front end Cover								
Rear end Cover								
Conn Rod								
Bolts	140217 (6)	140156 (4)	140157 (4)	140175 (6)				
Other Parts	Front bush	Rear Bearing	Inserts	Thrust Washer	Locking Tab	Valve Seat	Sump Gasket	
	050115	6207	050014 (2)	050108	050083 (2)	060070 (2)	010092	

**MAJORSELL REBUILD: 68A014R**

**MAJORSELL PARTS FOR: 109072**

Users:	CUMMINS	ERF						
OE:	3924878	109073						



Bore	Drive	Cooling	Weight	Mount	Lube	Water Port	Air inlet	Air delivery
2.5/8"	Non through	Water	20 Kg	Flange	Engine oil	1/2"	Manifold.	1/2"

Repair Kits	Service Kit	Gasket Kit	Valve Kit	Valve Plate	Cooling Plate	Unloader Kit		
	A68RK038A					A68RK056A		
Piston	Std	+0.010"	+0.020"	+0.030"	+0.040"			
	020028	020029	020030	020031	020032			
Rings	A68RK051	A68RK052	A68RK053	A68RK054	A68RK055			
Head								
Crankshaft		140240 (Nut)						
Front end Cover								
Rear end Cover								
Conn Rod								
Bolts	140217 (6)	140156 (4)	140157 (4)	140175 (6)				
Other Parts	Front bush	Rear Bearing	Inserts	Thrust Washer	Locking Tab	Valve Seat	Sump Gasket	
	050115	6207	050014 (2)	050108	050083 (2)	060070 (2)	010092	



Check our web site for suitability of these and other parts, or contact us directly. Original part numbers are fitted for reference only. Check all applications. All parts offered are Majorsell brand and may not be of an original supply. Majorsell kit content and ring sets may be different to the original.

**MAJORSELL PARTS FOR: 109250**

**MAJORSELL REBUILD: 68A133R**



Users:	CATERPILLAR							
OE:	109-1317							
Bore	Drive	Cooling	Weight	Mount	Lube	Water Port	Air inlet	Air delivery
2.78"	Non through	Water	22 Kg	Flange	Engine oil	½"	Manifold	½"

Repair Kits	Major Head Kit	Minor Head Kit	Gasket Kit	Valve Kit	Valve Plate	Cooling Plate	Ess Kit	
	A68RK096	A68RK096A					A68RK096D	
Piston	Std	+0.010"	+0.020"	+0.030"	+0.040"			
	020106	020107	020108	020109	020110			
Rings	A68RK097	A68RK098	A68RK099	A68RK100	A68RK101			
Head								
Crankshaft								
Front end Cover								
Rear end Cover								
Conn Rod								
Bolts	140163 (6)	140159 (4)	140157 (4)	140164 (4)	140164 (6)			
Other Parts	Front bush	Rear Bearing	Inserts	Thrust Washers		O Ring	Liner Sleeve	Lock Tabs
	050064	050115	050171 (2)	050114 (Front)	050108 (Rear)	BS241V	020994 (2)	050083 (2)
	Sump Gasket	Flange Gasket						
	010393	010098						

**MAJORSELL PARTS FOR: 109864**

**MAJORSELL REBUILD: 68A142R**



Users:	CAT							
OE:	109604							
Bore	Drive	Cooling	Weight	Mount	Lube	Water Port	Air inlet	Air delivery
2.78"	Non-through	Water	22 Kg	Flange	Engine oil	½"	Manifold	½"

Repair Kits	Major Head Kit	Minor Head Kit	Gasket Kit	Valve Kit	Valve Plate	Cooling Plate	Ess Kit	
	A68RK096	A68RK096A					A68RK096D	
Piston	Std	+0.010"	+0.020"	+0.030"	+0.040"			
	020101	020102	020103	020104	020105			
Rings	A68RK097	A68RK098	A68RK099	A68RK100	A68RK101			
Head								
Crankshaft		140301 (Nut)						
Front end Cover								
Rear end Cover								
Conn Rod								
Bolts	140163 (6)	140164 (4)	140164 (6)					
Other Parts	Front Bush	Rear Bush	Inserts	Thrust Washers		Locking Tab	Sump Gasket	O Ring
	050064	050115	050171 (2)	050114 (Front)	050108 (Rear)	050083 (2)	010393	BS241V
	Cover Gasket	Liner Sleeve						
	010060	020994 (2)						



Check our web site for suitability of these and other parts, or contact us directly. Original part numbers are fitted for reference only. Check all applications. All parts offered are Majorsell brand and may not be of an original supply. Majorsell kit content and ring sets may be different to the original.



**MAJORSELL REBUILD: 68A139R**

**MAJORSELL PARTS FOR: 227331**

Users:								
OE:								
Bore	Drive	Cooling	Weight	Mount	Lube	Water Port	Air inlet	Air delivery
2½"	Non through	Water	21 Kg	Base	Engine oil	¾"	Manifold	Manifold



Repair Kits	Service Kit	Head Kit	Gasket Kit	Valve Kit	Valve Plate	Cooling Plate	Unloader Kit	
	A69RK021A						A68RK056A	
Piston	Std	+0.010"	+0.020"	+0.030"	+0.040"			
	020000	020001	020002	020003	020004			
Rings	A68RK001	A68RK002	A68RK003	A68RK004	A68RK005			
Head	226098							
Crankshaft								
Front end Cover								
Rear end Cover								
Conn Rod								
Bolts	140173 (10)	140159 (4)	140157 (4)	140160 (4)	140157 (4)	140190 (6)	140175 (6)	
Other Parts	Front Bearing	Inserts	Thrust Washer	Locking Tab	Oil Ring	Oil Seal	Sump Gasket	
	6011	050009 (2)	050114	050083 (2)	090008	110014	010066	

**MAJORSELL REBUILD: 68A110R**

**MAJORSELL PARTS FOR: 229990**

Users:	RUSTON BUCYRUS							
OE:								
Bore	Drive	Cooling	Weight	Mount	Lube	Water Port	Air inlet	Air delivery
2½"	Non through	Water	39 Kg	Base	Engine oil	¾"	Flange	Flange



Repair Kits	Service Kit	Head Kit	Gasket Kit	Valve Kit	Valve Plate	Cooling Plate	Unloader Kit	
	A69RK021A						A68RK056A	
Piston	Std	+0.010"	+0.020"	+0.030"	+0.040"			
	020000	020001	020002	020003	020004			
Rings	A68RK001	A68RK002	A68RK003	A68RK004	A68RK005			
Head								
Crankshaft		140185 (Nut)	090004 (Key)					
Front end Cover								
Rear end Cover								
Conn Rod								
Bolts	140173 (20)	140190 (12)	140175 (12)	140159 (5)	140103 (5)	140159 (5)	140103 (5)	140161 (8)
	140162 (8)							
Other Parts	Bearing	Inserts	Gasket	Oil Ring	Oil Seal	Sump Gasket		
	6011	050095 (4)	010075	090008	110008	010076		



Check our web site for suitability of these and other parts, or contact us directly. Original part numbers are fitted for reference only. Check all applications. All parts offered are Majorsell brand and may not be of an original supply. Majorsell kit content and ring sets may be different to the original.

**MAJORSELL PARTS FOR: 271721**

**MAJORSELL REBUILD: 68A065R**



Users:	DAF	SCANIA	VOLVO					
OE:	BBU5512	6243117	571003	148085	141144			
Bore	Drive	Cooling	Weight	Mount	Lube	Water Port	Air inlet	Air delivery
2½"	Non through	Water	15Kg	Flange	Engine oil	3/8"	Manifold	Manifold

Repair Kits	Full Kit	Service Kit	Gasket Kit	Valve Kit	Valve Plate	Cooling Plate	Unloader Kit	D2 Gov Kit
	A69RK021	A69RK021A					A68RK056A	B68RK003
Piston	Std	+0.010"	+0.020"	+0.030"	+0.040"			
	020000	020001	020002	020003	020004			
Rings	A68RK001	A68RK002	A68RK003	A68RK004	A68RK005			
Alt Rings	A68RK014	A68RK015	A68RK016	A68RK017	A68RK018			
Head								
Crankshaft								
Front end Cover								
Rear end Cover								
Conn Rod								
Bolts								
Other Parts								

**MAJORSELL PARTS FOR: 274838**

**MAJORSELL REBUILD: 68A045R**



Users:	DAF	DENNIS	ERF	IVECO	VOLVO			
OE:	949929	60806	41432	L29274	650397	ACU5896	25C111148	8112781
BBU5505	650027	4719522	11202	VE39674				
Bore	Drive	Cooling	Weight	Mount	Lube	Water Port	Air inlet	Air delivery
2½"	Non-through	Water	21 Kg	Base	Engine oil	¾"	Manifold	Manifold

Repair Kits	Full Kit	Service Kit	Gasket Kit	Valve Kit	Valve Plate	Cooling Plate	Unloader Kit	D2 Gov Kit
	A69RK021	A69RK021A					A68RK056A	B68RK003
Piston	Std	+0.010"	+0.020"	+0.030"	+0.040"			
	020000	020001	020002	020003	020004			
Rings	A68RK001	A68RK002	A68RK003	A68RK004	A68RK005			
Alt Rings	A68RK014	A68RK015	A68RK016	A68RK017	A68RK018			
Head								
Crankshaft		140185 (Nut)						
Front end Cover								
Rear end Cover								
Conn Rod								
Bolts	140173 (10)	140172 (4)	140162 (4)	140160 (4)	140157 (4)			
Other Parts	Front Bearing	Rear Bearing	Inserts	Thrust Washer	Oil Seal	Oil Ring	Sump Gasket	Valve Seat
	6307	6011	050009 (2)	050114	110014	090008	010001	060070 (2)
	Valve Cap Nut							
	060140 (2)							

\*Fitted to: Gardner, Bristol VR Bus, Fleetline Bus, Olympian Bus, Dominator



Check our web site for suitability of these and other parts, or contact us directly. Original part numbers are fitted for reference only. Check all applications. All parts offered are Majorsell brand and may not be of an original supply. Majorsell kit content and ring sets may be different to the original.

**MAJORSELL REBUILD: 68A117R**

**MAJORSELL PARTS FOR: 274935**

Users:								
OE:								
Bore	Drive	Cooling	Weight	Mount	Lube	Water Port	Air inlet	Air delivery
2½"	Non-through	Water	21 Kg	Base	Engine oil	¾"	Manifold	Manifold



Repair Kits	Service Kit	Head Kit	Gasket Kit	Valve Kit	Valve Plate	Cooling Plate	Unloader Kit	
	A69RK021A						A68RK056A	
Piston	Std	+0.010"	+0.020"	+0.030"	+0.040"			
	020000	020001	020002	020003	020004			
Rings	A68RK001	A68RK002	A68RK003	A68RK004	A68RK005			
Head								
Crankshaft		140306 (Nut)						
Front end Cover								
Rear end Cover								
Conn Rod								
Bolts	140173 (10)	140161 (4)	140162 (4)	140159 (4)	140157 (4)	140190 (6)	140175 (6)	140161 (6)
Other Parts	Front Bearing	Rear Bearing	Inserts	Tab Washers	Oil Seal	Oil Ring	Sump Gasket	
	6307	6011	050005 (2)	050008 (4)	110014	090008	010001	

**MAJORSELL REBUILD: 68A056R**

**MAJORSELL PARTS FOR: 276961**

Users:	DETROIT							
OE:	275857	276111	276167	276843	226288	226862	227330	227579
228333	228334	228373	228421	228446	229470	229563	275039	
Bore	Drive	Cooling	Weight	Mount	Lube	Water Port	Air inlet	Air delivery
2½"	Non-through	Water	22 Kg	Flange	Engine oil	½"	Manifold	Manifold



Repair Kits	Service Kit	Head Kit	Gasket Kit	Valve Kit	Valve Plate	Cooling Plate	Unloader Kit	D2 Gov Kit
	A69RK021A		A69RK021B				A68RK056A	B68RK003
Piston	Std	+0.010"	+0.020"	+0.030"	+0.040"			
	020000	020001	020002	020003	020004			
Rings	A68RK001	A68RK002	A68RK003	A68RK004	A68RK005			
Alt Rings	A68RK014	A68RK015	A68RK016	A68RK017	A68RK018			
Head								
Crankshaft		140185 (Nut)						
Front end Cover								
Rear end Cover								
Conn Rod								
Bolts	140173 (10)	140159 (4)	140157 (4)	140161 (6)	140162 (6)			
Other Parts	Front Bush	Rear Bush	Inserts	Thrust Washer		Locking Tab	Oil Ring	Oil Seal
	050103	050109	050009 (2)	050108 (Front)	050114 (Rear)	050150 (4)	090008	110014
	Valve Seat	Valve Cap Nut						
	060070 (2)	060140 (2)						



Check our web site for suitability of these and other parts, or contact us directly. Original part numbers are fitted for reference only. Check all applications. All parts offered are Majorsell brand and may not be of an original supply. Majorsell kit content and ring sets may be different to the original.

**MAJORSELL PARTS FOR: 277057**

**MAJORSELL REBUILD: 68A100R**



Users:	CAT							
OE:	227320							
Bore	Drive	Cooling	Weight	Mount	Lube	Water Port	Air inlet	Air delivery
2½"	Non-through	Water	21 Kg	Base	Engine oil	¾"	Manifold	Manifold

Repair Kits	Full Kit	Service Kit	Gasket Kit	Valve Kit	Valve Plate	Cooling Plate	Unloader Kit	D2 Gov Kit
	A69RK021	A69RK021A	A69RK021B				A68RK056A	B68RK003
Piston	Std	+0.010"	+0.020"	+0.030"	+0.040"			
	020000	020001	020002	020003	020004			
Rings	A68RK001	A68RK002	A68RK003	A68RK004	A68RK005			
Alt Rings	A68RK014	A68RK015	A68RK016	A68RK017	A68RK018			
Head	220196							
Crankshaft		140185 (Nut)						
Front end Cover								
Rear end Cover								
Conn Rod								
Bolts	140173 (10)	140160 (4)	140159 (4)					
Other Parts	Front Bearing	Rear Bush	Inserts	Thrust Washer	Locking Tab	O Ring		Oil Seal
	6011	050109	050009 (2)	050114	050008 (4)	BS236	BS011	110029
	Valve Seat	Valve Cap Nut	Crankshaft Key					
	060070 (2)	060140 (2)	090004					

**MAJORSELL PARTS FOR: 280737**

**MAJORSELL REBUILD: 68A006R**



Users:	VOLVO							
OE:	1599919	1611815	351453	5001153				
Bore	Drive	Cooling	Weight	Mount	Lube	Water Port	Air inlet	Air delivery
2½"	Non-through	Water	21 Kg	Flange	Engine oil	¾"	Manifold	Manifold

Repair Kits	Full Kit	Service Kit	Gasket Kit	Valve Kit	Valve Plate		Unloader Kit	D2 Gov Kit
	A69RK021	A69RK021A	A69RK021B				A68RK056A	B68RK003
Piston	Std	+0.010"	+0.020"	+0.030"	+0.040"			
	020000	020001	020002	020003	020004			
Rings	A68RK001	A68RK002	A68RK003	A68RK004	A68RK005			
Alt Rings	A68RK014	A68RK015	A68RK016	A68RK017	A68RK018			
Head								
Crankshaft			090004 (Key)					
Front end Cover								
Rear end Cover								
Conn Rod								
Bolts	140173 (10)	140160 (4)	140103 (4)	140161 (6)				
Other Parts	Front Bearing	Rear Bearing	Inserts	Locking Tab	Oil Ring	Sump Gasket	O Ring	Valve Seat
	6207 (2)	6011	050005 (2)	050008 (4)	090008 (4)	010027	RM1150-30V	060070 (2)
	Valve Cap Nut							
	060140 (2)							



Check our web site for suitability of these and other parts, or contact us directly. Original part numbers are fitted for reference only. Check all applications. All parts offered are Majorsell brand and may not be of an original supply. Majorsell kit content and ring sets may be different to the original.

**MAJORSELL REBUILD: 68A092R**

**MAJORSELL PARTS FOR: 282397**

Users:	TEREX							
OE:	5144303	229695	275007	276915	277242	279921	286418	
Bore	Drive	Cooling	Weight	Mount	Lube	Water Port	Air inlet	Air delivery
2½"	Non-through	Water	20 Kg	Flange	Engine oil	¾"	Manifold	Manifold



Repair Kits	Full Kit	Service Kit	Gasket Kit	Valve Kit	Valve Plate	Unloader Kit	D2 Gov Kit	
	A69RK021	A69RK021A	A69RK021B			A68RK056A	B68RK003	
Piston	Std	+0.010"	+0.020"	+0.030"	+0.040"			
	020000	020001	020002	020003	020004			
Rings	A68RK001	A68RK002	A68RK003	A68RK004	A68RK005			
Alt Rings	A68RK014	A68RK015	A68RK016	A68RK017	A68RK018			
	A68RK072	A68RK073	A68RK074	A68RK075	A68RK076			
Head								
Crankshaft		140185 (Nut)						
Front end Cover								
Rear end Cover								
Conn Rod								
Bolts	140173 (10)	140159 (4)	140157 (4)					
Other Parts	Front Bush	Rear Bush	Inserts	Thrust Washer		Locking Tab	Oil Ring	Oil Seal
	050103	050109	050009 (2)	050108 (Front)	050114(Rear)	050008 (4)	090008	110014
	Valve Seat	Valve Cap Nut	O Ring					
	060070 (2)	060140 (2)	BS236					

**MAJORSELL REBUILD: 68A089R**

**MAJORSELL PARTS FOR: 282404**

Users:	DETROIT	NAVISTAR						
OE:	276777	275725	278562	279162	283348			
Bore	Drive	Cooling	Weight	Mount	Lube	Water Port	Air inlet	Air delivery
2½"	Non-through	Water	36 Kg	Flange	Engine oil	¾"	Flange	Flange



Repair Kits	Full Kit	Service Kit	Gasket Kit	Valve Kit	Valve Plate	Cooling Plate	Unloader Kit	D2 Gov Kit
	A69RK021	A69RK021A	A69RK021B				A68RK056A	B68RK003
Piston	Std	+0.010"	+0.020"	+0.030"	+0.040"			
	020000	020001	020002	020003	020004			
Rings	A68RK001	A68RK002	A68RK003	A68RK004	A68RK005			
Alt Rings	A68RK014	A68RK015	A68RK016	A68RK017	A68RK018			
Head								
Crankshaft		140185 (Nut)						
Front end Cover								
Rear end Cover								
Conn Rod								
Bolts	140173 (20)	140159 (5)	140103 (5)					
Other Parts	Front Bearing	Rear Bearing	Inserts	Gasket	Oil Ring	Sump Gasket	Flange Gasket	Oil Seal
	6207	6011	050095 (4)	010075	090008	010079	010059	110008
	Valve Seat	Valve Cap Nut						
	060070 (2)	060140 (2)						

\*Detroit 'O' degrees straight

\*Used on Navistar Detroit 8V71



Check our web site for suitability of these and other parts, or contact us directly. Original part numbers are fitted for reference only. Check all applications. All parts offered are Majorsell brand and may not be of an original supply. Majorsell kit content and ring sets may be different to the original.

**MAJORSELL PARTS FOR: 285923**

**MAJORSELL REBUILD: 68A104R**



Users:	DETROIT								
OE:	286576								
Bore	Drive	Cooling	Weight	Mount	Lube	Water Port	Air inlet	Air delivery	
2 5/8"	Non through	Water	20 Kg	Base	Engine oil	1/2"	Manifold	Manifold	

Repair Kits	Service Kit	Head Kit	Gasket Kit	Valve Kit	Valve Plate	Cooling Plate	Unloader Kit	
	A68RK038A						A68RK056A	
Piston	Std	+0.010"	+0.020"	+0.030"	+0.040"			
	020028	020029	020030	020031	020032			
Rings	A68RK051	A68RK052	A68RK053	A68RK054	A68RK055			
Alt Rings	A68RK067	A68RK068	A68RK069	A68RK070	A68RK071			
	A68RK046	A68RK047	A68RK048	A68RK049	A68RK050			
Head								
Crankshaft			090004 (Key)					
Front end Cover								
Rear end Cover								
Conn Rod								
Bolts	140217 (6)	140219 (4)	140218 (4)	140194 (6)				
Other Parts	Front Bearing	Rear Bush	Inserts	Thrust Washer	Locking Tab	Oil Seal		
	6207	050115	050014 (2)	050108	050083 (2)	110014		

**MAJORSELL PARTS FOR: 285924**

**MAJORSELL REBUILD: 68A107R**



Users:	DETROIT								
OE:	286578								
Bore	Drive	Cooling	Weight	Mount	Lube	Water Port	Air inlet	Air delivery	
2 5/8"	Non through	Water	20 Kg	Base	Engine oil	1/2"	Flange	Flange	

Repair Kits	Service Kit	Head Kit	Gasket Kit	Valve Kit	Valve Plate	Cooling Plate	Unloader Kit	
	A68RK038A						A68RK056A	
Piston	Std	+0.010"	+0.020"	+0.030"	+0.040"			
	020028	020029	020030	020031	020032			
Rings	A68RK051	A68RK052	A68RK053	A68RK054	A68RK055			
Alt Rings	A68RK067	A68RK068	A68RK069	A68RK070	A68RK071			
	A68RK046	A68RK047	A68RK048	A68RK049	A68RK050			
Head								
Crankshaft		140185 (Nut)	090004 (Key)					
Front end Cover								
Rear end Cover								
Conn Rod								
Bolts	140217 (6)	140219 (4)	140218 (4)	140194 (6)				
Other Parts	Front Bearing	Rear Bearing	Inserts	Locking Tab	Thrust Washer	Oil Seal		
	6207	050115	050014 (2)	050083 (2)	050108	110014		



Check our web site for suitability of these and other parts, or contact us directly. Original part numbers are fitted for reference only. Check all applications. All parts offered are Majorsell brand and may not be of an original supply. Majorsell kit content and ring sets may be different to the original.

**MAJORSELL REBUILD: 68A088R**

**MAJORSELL PARTS FOR: 285970**

Users:	DETROIT							
OE:	286538	282094						



Bore	Drive	Cooling	Weight	Mount	Lube	Water Port	Air inlet	Air delivery
2 5/8"	Non through	Water	22Kg	Flange	Engine oil	1/2"	Manifold	Manifold

Repair Kits	Service Kit	Head Kit	Gasket Kit	Valve Kit	Valve Plate	Cooling Plate	Unloader Kit	
	A68RK038A						A68RK056A	
Piston	Std	+0.010"	+0.020"	+0.030"	+0.040"			
	020028	020029	020030	020031	020032			
Rings	A68RK051	A68RK052	A68RK053	A68RK054	A68RK055			
Head								
Crankshaft		140185 (Nut)	090004 (Key)					
Front end Cover								
Rear end Cover								
Conn Rod								
Bolts	140217 (6)	140219 (4)	140218 (4)	140192 (6)	140175 (6)			
Other Parts	Bush (Front & Back)	Inserts	Thrust Washer	Sump Gasket	Locking Tab	Gasket	O Ring	
	050115	050014 (2)	050108 (2)	010092	050083 (2)	010059	RM1150-30V	

\*Used on Detroit Diesel GMC IHC

**MAJORSELL REBUILD: 68A047R**

**MAJORSELL PARTS FOR: 286017**

Users:	CAT							
OE:	286580							



Bore	Drive	Cooling	Weight	Mount	Lube	Water Port	Air inlet	Air delivery
2 5/8"	Non through	Water	20Kg	Base	Engine oil	1/2"	Manifold	Manifold

Repair Kits	Service Kit	Head Kit	Gasket Kit	Valve Kit	Valve Plate	Cooling Plate	Unloader Kit	
	A68RK038A						A68RK056A	
Piston	Std	+0.010"	+0.020"	+0.030"	+0.040"			
	020028	020029	020030	020031	020032			
Rings	A68RK051	A68RK052	A68RK053	A68RK054	A68RK055			
Head								
Crankshaft		140185 (Nut)	090004 (Key)					
Front end Cover								
Rear end Cover								
Conn Rod								
Bolts	140217 (6)	140219 (4)	140218 (4)	140194 (6)				
Other Parts	Front Bearing	Rear Bush	Inserts	Thrust Washer	Locking Tab	Oil Seal	Sump Gasket	
	6207	050115	050014 (2)	050108	050083 (2)	110014	010092	



Check our web site for suitability of these and other parts, or contact us directly. Original part numbers are fitted for reference only. Check all applications. All parts offered are Majorsell brand and may not be of an original supply. Majorsell kit content and ring sets may be different to the original.

**MAJORSELL PARTS FOR: 286104**

**MAJORSELL REBUILD: 68A005R**



Users:	VOLVO	SCANIA						
OE:	1508996	5001477	9001508996	286563				
Bore	Drive	Cooling	Weight	Mount	Lube	Water Port	Air inlet	Air delivery
2 5/8"	Non through	Water	20Kg	Flange	Engine oil	1/2"	Manifold	Manifold

Repair Kits	Service Kit A68RK038A	Head Kit	Gasket Kit	Valve Kit	Valve Plate	Cooling Plate	Unloader Kit A68RK056A	
Piston	Std 020028 020130	+0.010" 020029 020131	+0.020" 020030 020132	+0.030" 020031 020133	+0.040" 020032 020134			
Rings	A68RK051	A68RK052	A68RK053	A68RK054	A68RK055			
Alt Rings	A68RK067 A68RK046	A68RK068 A68RK047	A68RK069 A68RK048	A68RK070 A68RK049	A68RK071 A68RK050			
Head								
Crankshaft		140185 (Nut)	090004 (Key)					
Front end Cover								
Rear end Cover								
Conn Rod								
Bolts	140217 (6)	140219 (2)	140218 (4)					
Other Parts	Bush (Front & Back) 050115	Inserts 050014 (2)	Thrust Washer 050108	Locking Tab 050083 (2)	Valve Seat 060070 (2)	Sump Gasket 010092	O Ring RM1150-30V	Oil Seal 110014

**MAJORSELL PARTS FOR: 286538**

**MAJORSELL REBUILD: 68A102R**



Users:	KERSHAW	EATON	FORD	WHITING	GMC	DETROIT		
OE:	285985	285987	285989	287076	285970	285971		
Bore	Drive	Cooling	Weight	Mount	Lube	Water Port	Air inlet	Air delivery
2 5/8"	Non through	Water	20Kg	Flange	Engine oil	1/2"	Manifold	Manifold

Repair Kits	Service Kit A68RK038A	Head Kit	Gasket Kit	Valve Kit	Valve Plate	Cooling Plate	Unloader Kit A68RK056A	
Piston	Std 020028	+0.010" 020029	+0.020" 020030	+0.030" 020031	+0.040" 020032			
Rings	A68RK051	A68RK052	A68RK053	A68RK054	A68RK055			
ALT Rings	A68RK046 A68RK067	A68RK047 A68RK068	A68RK048 A68RK069	A68RK049 A68RK070	A68RK050 A68RK071			
Head	220325							
Crankshaft		140185 (Nut)	090004 (Key)					
Front end Cover								
Rear end Cover								
Conn Rod								
Bolts	140217 (6)	140219 (2)	140218 (4)	140192 (6)	140175 (6)			
Other Parts	Bush (Front & Back) 050115	Inserts 050014 (2)	Thrust Washer 050108	Locking Tab 050083 (2)	Sump Gasket 010092	Flange Gasket 010059		

\*Used on Detroit Diesel GMC, Ford, IHC, Eaton



Check our web site for suitability of these and other parts, or contact us directly. Original part numbers are fitted for reference only. Check all applications. All parts offered are Majorsell brand and may not be of an original supply. Majorsell kit content and ring sets may be different to the original.



**MAJORSELL REBUILD: 68A084R**

**MAJORSELL PARTS FOR: 286539**

Users:	DETROIT	GMC	FREIGHTLINER	IHC	FORD	WHITING	DROTT	
OE:	285976	285977	285988	286066	286200	286217		



Bore	Drive	Cooling	Weight	Mount	Lube	Water Port	Air inlet	Air delivery
2 5/8"	Non through	Water	20Kg	Flange	Engine oil	1/2"	Manifold	Manifold

Repair Kits	Service Kit	Head Kit	Gasket Kit	Valve Kit	Valve Plate	Cooling Plate	Unloader Kit
	A68RK038A						A68RK056A
Piston	Std	+0.010"	+0.020"	+0.030"	+0.040"		
	020028	020029	020030	020031	020032		
Rings	A68RK051	A68RK052	A68RK053	A68RK054	A68RK055		
ALT Rings	A68RK046	A68RK047	A68RK048	A68RK049	A68RK050		
	A68RK067	A68RK068	A68RK069	A68RK070	A68RK071		
Head							
Crankshaft		140185 (Nut)	090004 (Key)				
Front end Cover							
Rear end Cover							
Conn Rod							
Bolts	140217 (6)	140219 (4)	140218 (4)	140192 (6)	140175 (6)		
Other Parts	Bushes (Front & Rear)	Inserts	Thrust Washer	Locking Tab	Sump Gasket	Flange Gasket	
	050115	050014 (2)	050108	050083 (2)	010092	010059	

**MAJORSELL REBUILD: 68A149R**

**MAJORSELL PARTS FOR: 286550**

Users:	CAT							
OE:								



Bore	Drive	Cooling	Weight	Mount	Lube	Water Port	Air inlet	Air delivery
2 5/8"	Non through	Water	20Kg	Flange	Engine oil	1/2"	Manifold	1/2"

Repair Kits	Full Kit	Head Kit	Gasket Kit	Valve Kit	Valve Plate	Cooling Plate	Gov Kit
	A68RK038A						A68RK056A
Piston	Std	+0.010"	+0.020"	+0.030"	+0.040"		
	020028	020029	020030	020031	020032		
Rings	A68RK051	A68RK052	A68RK053	A68RK054	A68RK055		
Head							
Crankshaft		140141 (Nut)					
Front end Cover							
Rear end Cover							
Conn Rod							
Bolts	140217 (6)	140218 (4)	140218 (4)				
Other Parts	Bushes (Front & Rear)	Inserts	Thrust Washer	Locking Tab	Sump Gasket	Flange Gasket	Valve Seat
	050115	050014 (2)	050108 (2)	050083 (2)	010092	010059	060014 (2)



Check our web site for suitability of these and other parts, or contact us directly. Original part numbers are fitted for reference only. Check all applications. All parts offered are Majorsell brand and may not be of an original supply. Majorsell kit content and ring sets may be different to the original.

**MAJORSELL PARTS FOR: 286552**

**MAJORSELL REBUILD: 68A156R**



Users:	CUMMINS								
OE:	3924878								
Bore	Drive	Cooling	Weight	Mount	Lube	Water Port	Air inlet	Air delivery	
2 5/8"	Non through	Water	20Kg	Flange	Engine oil	1/2"	Manifold	1/2"	

Repair Kits	Full Kit	Head Kit	Gasket Kit	Valve Kit	Valve Plate	Cooling Plate		
	A68RK038A							
Piston	Std	+0.010"	+0.020"	+0.030"	+0.040"			
	020028	020029	020030	020031	020032			
Rings	A68RK051	A68RK052	A68RK053	A68RK054	A68RK055			
Head								
Crankshaft		140185 (Nut)						
Front end Cover								
Rear end Cover								
Conn Rod								
Bolts	140217 (6)	140156 (4)	140157 (4)	140175 (6)				
Other Parts	Bushes (Front & Rear)	Inserts	Thrust Washer	Locking Tab	Sump Gasket	O Ring	Valve Seat	
	050115	050014 (2)	050108	050083 (2)	010092	BS040	060070 (2)	

**MAJORSELL PARTS FOR: 286578**

**MAJORSELL REBUILD: 68A108R**



Users:	DETROIT							
OE:	285924							
Bore	Drive	Cooling	Weight	Mount	Lube	Water Port	Air inlet	Air delivery
2 5/8"	Non through	Water	20 Kg	Side	Engine oil	3/4"	Manifold	Manifold

Repair Kits	Service Kit	Head Kit	Gasket Kit	Valve Kit	Valve Plate	Cooling Plate	Unloader Kit	
	A68RK038A						A68RK056A	
Piston	Std	+0.010"	+0.020"	+0.030"	+0.040"			
	020028	020029	020030	020031	020032			
Rings	A68RK051	A68RK052	A68RK053	A68RK054	A68RK055			
ALT Rings	A68RK046	A68RK047	A68RK048	A68RK049	A68RK050			
	A68RK067	A68RK068	A68RK069	A68RK070	A68RK071			
Head								
Crankshaft			090004 (Key)					
Front end Cover								
Rear end Cover								
Conn Rod								
Bolts	140217(6)	140175 (6)	140219 (4)	140218 (4)	140194 (6)			
Other Parts	Bush & Bearing		Inserts	Thrust Washer	Locking Tab	Sump Gasket	Oil Seal	
	6207 (Front)	050115 (Rear)	050014 (2)	050108	050083 (2)	010092	110014	



Check our web site for suitability of these and other parts, or contact us directly. Original part numbers are fitted for reference only. Check all applications. All parts offered are Majorsell brand and may not be of an original supply. Majorsell kit content and ring sets may be different to the original.

**MAJORSELL REBUILD: 68A131R**

**MAJORSELL PARTS FOR: 286584**

Users:	CAT							
OE:	7E6807							



Bore	Drive	Cooling	Weight	Mount	Lube	Water Port	Air inlet	Air delivery
2 5/8"	Non through	Water	20 Kg	Flange	Engine oil	In: 3/8" / Out: 1/2"	Flange	1/2"

Repair Kits	Service Kit	Head Kit	Gasket Kit	Valve Kit	Valve Plate	Cooling Plate	Unloader Kit
	A68RK038A						A68RK056A
Piston	Std	+0.010"	+0.020"	+0.030"	+0.040"		
	020028	020029	020030	020031	020032		
Rings	A68RK051	A68RK052	A68RK053	A68RK054	A68RK055		
Head							
Crankshaft							
Front end Cover							
Rear end Cover							
Conn Rod							
Bolts	140217 (6)	140218 (4)	140192 (6)	140175 (6)			
Other Parts	Bushes (Front & Rear)	Inserts	Thrust Washer	Locking Tab	Gasket	Gasket	
	050115	050014 (2)	050108	050083 (2)	010092 (Sump)	010098 (Mount)	

**MAJORSELL REBUILD: 68A071R**

**MAJORSELL PARTS FOR: 287631**

Users:	CAT							
OE:	286567	287632						



Bore	Drive	Cooling	Weight	Mount	Lube	Water Port	Air inlet	Air delivery
2 5/8"	Non through	Water	18 Kg	Base	Engine oil	1/2"	Manifold	Manifold

Repair Kits	Service Kit	Head Kit	Gasket Kit	Valve Kit	Valve Plate	Cooling Plate	Unloader Kit
	A68RK038A						A68RK056A
Piston	Std	+0.010"	+0.020"	+0.030"	+0.040"		
	020028	020029	020030	020031	020032		
Rings	A68RK051	A68RK052	A68RK053	A68RK054	A68RK055		
ALT Rings	A68RK046	A68RK047	A68RK048	A68RK049	A68RK050		
	A68RK067	A68RK068	A68RK069	A68RK070	A68RK071		
Head							
Crankshaft		140185 (Nut)	090004 (Key)				
Front end Cover							
Rear end Cover							
Conn Rod							
Bolts	140217(6)	140175 (6)	140219 (4)	140218 (4)			
Other Parts	Bearing	Inserts	Thrust Washer	Locking Tab	Oil Seal		
	6207	050014 (2)	050108	050083 (2)	110014		



Check our web site for suitability of these and other parts, or contact us directly. Original part numbers are fitted for reference only. Check all applications. All parts offered are Majorsell brand and may not be of an original supply. Majorsell kit content and ring sets may be different to the original.

**MAJORSELL PARTS FOR: 289257**

**MAJORSELL REBUILD: 68A022R**



Users:	VOLVO								
OE:	289347								
Bore	Drive	Cooling	Weight	Mount	Lube	Water Port	Air inlet	Air delivery	
2 3/4"	Non through	Water	23 Kg	Flange	Engine oil	1/2"	Manifold	Manifold	

Repair Kits	Full Kit	Service Kit	Gasket Kit	Valve Kit	Valve Plate	Cooling Plate	Unloader Kit	
	A68RK058	A68RK058A					A68RK038A	
Piston	Std	+0.010"	+0.020"	+0.030"	+0.040"			
	020038	020039	020040	020041	020042			
Rings	A68RK019	A68RK020	A68RK021	A68RK022	A68RK023			
Head	220196							
Crankshaft		140185 (Nut)	090004 (Key)					
Front end Cover								
Rear end Cover								
Conn Rod								
Bolts	140173 (10)	140160 (4)	140175 (4)	140161 (4)				
Other Parts	Front bearing	Rear Bearing	Inserts	Thrust Washer	Locking Tab	O Ring	Valve Seat	Valve Cap Nut
	6207 (2)	6011	050009 (2)	050114	050083 (2)	RM1150-30V	060070 (2)	060140 (2)

**MAJORSELL PARTS FOR: 1186616**

**MAJORSELL REBUILD: 68A076R**



Users:	CUMMINS	IVECO	FORD					
OE:	3280815	89DB287BA						
Bore	Drive	Cooling	Weight	Mount	Lube	Water Port	Air inlet	Air delivery
80 mm	Through	Water	12 Kg	Flange	Engine oil	3/8"	3/4"	3/4"

Repair Kits	Full Kit	Head Kit	Gasket Kit	Valve Kit	Valve Plate	Cooling Plate		
	A68RK105	A68RK105A	A68RK105B	A68RK105C	A68RK109V			
Piston	Std	+0.25 mm	+0.50 mm	+0.75 mm	+1.00 mm			
	020140		020141		020142			
Rings	A68RK110		A68RK111		A68RK114			
Head								
Crankshaft		140141 (Nut)						
Front end Cover								
Rear end Cover								
Conn Rod								
Bolts	140149 (4)	140138 (4)	140135 (4)	140125 (4)				
Other Parts	Bushes (Front & Rear)	Front Flange Seal		Sump cover				
	050203	010458		220097				



Check our web site for suitability of these and other parts, or contact us directly. Original part numbers are fitted for reference only. Check all applications. All parts offered are Majorsell brand and may not be of an original supply. Majorsell kit content and ring sets may be different to the original.

## MAJORSELL REBUILD: 68A003R

## MAJORSELL PARTS FOR: 1189106

Users:	ERF	DAF	SCANIA					
OE:	394441	1300366	1348919	571181	571185			



Bore	Drive	Cooling	Weight	Mount	Lube	Water Port	Air inlet	Air delivery
75 mm	Non through	Water	19 Kg	Flange	Engine oil	18 mm	Flange	Flange

Repair Kits	Universal Kit	Head Kit	Gasket Kit	Valve Kit	Valve Plate	Cooling Plate	Filter Kit	
	A68RK094		A68RK006B		220020		A68RK006F	
Piston	Std	+0.010"	+0.020"	+0.030"	+0.040"			
	020011	020012	020013	020014	020088			
Rings	A68RK024	A68RK025	A68RK026	A68RK027	A68RK095			
Head	220021							
Crankshaft	220008	140014 (Nut)	090004 (Key)					
Front end Cover								
Rear end Cover	220009							
Conn Rod	220019							
Bolts	140120 (10)	140126 (2)	140124 (3)	140103 (3)	140125 (8)			
Other Parts	Front Bearing	Rear Bush	Bearing Circlip	O Ring	Valve Seat	Base Plate	Crank Key	
	6207	050049	130010	RM1150-30V	060142 (2)	220097 (2)	090004	

## MAJORSELL REBUILD: 68A106R

## MAJORSELL PARTS FOR: 1189140

Users:	CUMMINS							
OE:	328290	3282190						



Bore	Drive	Cooling	Weight	Mount	Lube	Water Port	Air inlet	Air delivery
75 mm	Through	Water	10 Kg	Flange	Engine oil	3/8"	3/4"	3/4"

Repair Kits	Full Kit	Head Kit	Gasket Kit	Valve Kit	Valve Plate	Cooling Plate		
		A68RK104A	A68RK104B	A68RK104C	A68RK104V	A68RK105CP		
Piston	Std	+0.010"	+0.020"	+0.030"	+0.040"			
	020011	020012	020013	020014	020088			
Rings	A68RK024	A68RK025	A68RK026	A68RK027	A68RK095			
Head	220569							
Crankshaft		140240 (Nut)						
Front end Cover								
Rear end Cover								
Conn Rod								
Bolts	140149 (4)	140138 (4)	140135 (4)	140125 (4)				
Other Parts	Front bush	Rear Bush	Base Plate	Front Flange Seal				
	050203	050158	220097	010458				



Check our web site for suitability of these and other parts, or contact us directly. Original part numbers are fitted for reference only. Check all applications. All parts offered are MajorSell brand and may not be of an original supply. MajorSell kit content and ring sets may be different to the original.

**MAJORSELL PARTS FOR: 1189385**

**MAJORSELL REBUILD: 68A121R**



Users:	PERKINS								
OE:	2488A280								
Bore	Drive	Cooling	Weight	Mount	Lube	Water Port	Air inlet	Air delivery	
80 mm	Through	Water	12 Kg	Flange	Engine oil	3/8"	M26 x 1.5	M26 x 1.5	

Repair Kits	Service Kit	Head Kit	Gasket Kit	Valve Kit	Valve Plate	Cooling Plate		
	A68RK105A		A68RK105B	A68RK105C	A68RK105V			
Piston	Std	+0.25 mm	+0.50 mm	+0.75 mm	+1.00 mm			
	020140		020141		020142			
Rings	A68RK110		A68RK111		A68RK114			
Head								
Crankshaft		140141 (Nut)						
Front end Cover								
Rear end Cover								
Conn Rod								
Bolts	140102 (4)	140150 (4)	140125 (4)					
Other Parts	Front bush	Rear Bush	Front Flange Seal		Base Plate	Gasket		
	050203	050211	010458		220097	010208		

**MAJORSELL PARTS FOR: 1189495**

**MAJORSELL REBUILD: 68A122R**



Users:	PERKINS							
OE:	2488A283							
Bore	Drive	Cooling	Weight	Mount	Lube	Water Port	Air inlet	Air delivery
80 mm	Through	Water	12 Kg	Flange	Engine oil	1/2"	3/4"	3/4"

Repair Kits	Full Kit	Head Kit	Gasket Kit	Valve Kit	Valve Plate	Cooling Plate		
	A68RK105	A68RK105A	A68RK105B	A68RK105C	A68RK105V			
Piston	Std	+0.25 mm	+0.50 mm	+0.75 mm	+1.00 mm			
	020140		020141		020142			
Rings	A68RK110		A68RK111		A68RK114			
Head								
Crankshaft		140141 (Nut)						
Front end Cover								
Rear end Cover								
Conn Rod	220676							
Bolts	140102 (4)	140135 (4)	140103 (4)	140125 (4)				
Other Parts	Front bush	Rear Bearing	Front Flange Seal		Base Plate	Gasket		
	050203	6207	010458		220097	010208		



Check our web site for suitability of these and other parts, or contact us directly. Original part numbers are fitted for reference only. Check all applications. All parts offered are Majorsell brand and may not be of an original supply. Majorsell kit content and ring sets may be different to the original.

## MAJORSELL REBUILD: 68A018R

MAJORSELL PARTS FOR: 1189497

Users:	PERKINS	DAF						
OE:	2488A285	3906251						



Bore	Drive	Cooling	Weight	Mount	Lube	Water Port	Air inlet	Air delivery
75 mm	Through	Water	10 Kg	Flange	Engine oil	½"	¾"	½"

Repair Kits	Service Kit	Head Kit	Gasket Kit	Valve Kit	Valve Plate	Cooling Plate		
	A68RK104A		A68RK104B	A68RK104C	A68RK104V			
Piston	Std	+0.010"	+0.020"	+0.030"	+0.040"			
	020011	020012	020013	020014	020088			
Rings	A68RK010	A68RK011	A68RK012	A68RK013	A68RK095			
Head								
Crankshaft		140141 (Nut)						
Front end Cover								
Rear end Cover								
Conn Rod								
Bolts	140102 (4)	140135 (4)	140125 (8)					
Other Parts	Front bush	Rear Bush	Front Flange Seal		Base Plate	Gasket		
	050203	050211	010458		220097	010208		

## MAJORSELL REBUILD: 68A025R

MAJORSELL PARTS FOR: 1189498

Users:	PERKINS							
OE:	2488A286							



Bore	Drive	Cooling	Weight	Mount	Lube	Water Port	Air inlet	Air delivery
75 mm	Through	Water	10 Kg	Flange	Engine oil	½"	¾"	½"

Repair Kits	Service Kit	Head Kit	Gasket Kit	Valve Kit	Valve Plate	Cooling Plate		
	A68RK104A		A68RK104B	A68RK104C	A68RK104V1			
Piston	Std	+0.010"	+0.020"	+0.030"	+0.040"			
	020011	020012	020013	020014	020088			
Rings	A68RK010	A68RK011	A68RK012	A68RK013	A68RK095			
Head								
Crankshaft		140141 (Nut)						
Front end Cover								
Rear end Cover								
Conn Rod								
Bolts	140102 (4)	140135 (4)	140125 (4)					
Other Parts	Front Bushes	Rear Bush	Base Plate	Gasket	Front Flange Seal			
	050203	050211	220097	010208	010458			



Check our web site for suitability of these and other parts, or contact us directly. Original part numbers are fitted for reference only. Check all applications. All parts offered are Majorsell brand and may not be of an original supply. Majorsell kit content and ring sets may be different to the original.

**MAJORSELL PARTS FOR: 1189499**

**MAJORSELL REBUILD: 68A044R**



Users:	PERKINS								
OE:	2488A287								
Bore	Drive	Cooling	Weight	Mount	Lube	Water Port	Air inlet	Air delivery	
80 mm	Through	Water	12 Kg	Flange	Engine oil	½"	26mm	26mm	

Repair Kits	Service Kit	Head Kit	Gasket Kit	Valve Kit	Valve Plate	Cooling Plate		
	A68RK105A		A68RK105B	A68RK105C	A68RK105V			
Piston	Std	+0.25 mm	+0.50 mm	+0.75 mm	+1.00 mm			
	020140		020141		020142			
Rings	A68RK110		A68RK111		A68RK114			
Head								
Crankshaft		140141 (Nut)						
Front end Cover								
Rear end Cover								
Conn Rod								
Bolts	140102 (4)	140150 (4)	140125 (4)					
Other Parts	Bush (Front & Rear)		Front Flange Seal		Base Plate	Gasket		
	050203		010458		220097	010208		

**MAJORSELL PARTS FOR: 1194125**

**MAJORSELL REBUILD: 68A024R**



Users:	PERKINS	VOLVO						
OE:	2488A289	3950746						
Bore	Drive	Cooling	Weight	Mount	Lube	Water Port	Air inlet	Air delivery
75 mm	Through	Water	10 Kg	Flange	Engine oil	22 mm	26 mm	26 mm

Repair Kits	Full Kit	Head Kit	Gasket Kit	Valve Kit	Valve Plate	Cooling Plate		
	A68RK118	A68RK118A	A68RK118B	A68RK115C	A68RK118V			
Piston	Std	+0.25 mm	+0.50 mm	+0.75 mm	+1.00 mm			
	020124		020125		020126			
Rings	A66RK027		A66RK028		A66RK029			
Head								
Crankshaft		140141 (Nut)						
Front end Cover								
Rear end Cover								
Conn Rod								
Bolts	140120 (4)	140132	140135 (4)	140134 (4)				
Other Parts	Front bush	Rear Bearing	Front Flange Seal					
	050203	6207	010458					



Check our web site for suitability of these and other parts, or contact us directly. Original part numbers are fitted for reference only. Check all applications. All parts offered are Majorsell brand and may not be of an original supply. Majorsell kit content and ring sets may be different to the original.



## MAJORSELL REBUILD: 68A130R

## MAJORSELL PARTS FOR: 1194190

Users:	CUMMINS							
OE:	3283807							



Bore	Drive	Cooling	Weight	Mount	Lube	Water Port	Air inlet	Air delivery
80 mm	Through	Water	12 Kg	Flange	Engine oil	3/8"	3/4"	3/4"

Repair Kits	Full Kit	Head Kit	Gasket Kit	Valve Kit	Valve Plate	Cooling Plate		
	A68RK105	A68RK105A	A68RK105B	A68RK105C	A68RK109V	A68RK105CP		
Piston	Std	+0.25 mm	+0.50 mm	+0.75 mm	+1.00 mm			
	020140		020141		020142			
Rings	A68RK110		A68RK111		A68RK114			
Head								
Crankshaft		140141 (Nut)						
Front end Cover								
Rear end Cover								
Conn Rod								
Bolts	140149 (4)	140138 (4)	140150 (4)	140125 (4)				
Other Parts	Front bush	Rear Bush	O Ring	Gasket	Gasket	Gasket	Base Plate	Gasket
	050203	050210	BS534	010251	010250	010200	220097	010208

## MAJORSELL REBUILD: 68A026R

## MAJORSELL PARTS FOR: 1194212

Users:	PERKINS							
OE:	2488A290							



Bore	Drive	Cooling	Weight	Mount	Lube	Water Port	Air inlet	Air delivery
75 mm	Through	Water	10 Kg	Flange	Engine oil	1/2"	26 mm	26 mm

Repair Kits	Full Kit	Head Kit	Gasket Kit	Valve Kit	Valve Plate	Cooling Plate		
		A68RK104A	A68RK104B	A68RK104C	A68RK104V			
Piston	Std	+0.25 mm	+0.50 mm	+0.75 mm	+1.00 mm			
	020011	020012	020013	020014	020088			
Rings	A68RK010	A68RK011	A68RK012	A68RK013	A68RK095			
Head								
Crankshaft		140141 (Nut)						
Front end Cover								
Rear end Cover								
Conn Rod								
Bolts	140102 (4)	140135 (4)	140125 (4)					
Other Parts	Front bush	Rear Bush	Front Flange Seal		Base Plate	Gasket		
	050203	050211	010458		220097	010208		



Check our web site for suitability of these and other parts, or contact us directly. Original part numbers are fitted for reference only. Check all applications. All parts offered are Majorsell brand and may not be of an original supply. Majorsell kit content and ring sets may be different to the original.

**MAJORSELL PARTS FOR: 1194215**

**MAJORSELL REBUILD: 68A112R**



Users:	DAF	DENNIS	CUMMINS					
OE:	3283968	3279412	657033	653613	HBU2579			
Bore	Drive	Cooling	Weight	Mount	Lube	Water Port	Air inlet	Air delivery
80 mm	Through	Water	12 Kg	Flange	Engine oil	3/8 "	3/4 "	3/4 "

Repair Kits	Full Kit	Head Kit	Gasket Kit	Valve Kit	Valve Plate	Cooling Plate		
	A68RK105	A68RK105A	A68RK105B	A68RK105C	A68RK109V	A68RK105CP		
Piston	Std	+0.25 mm	+0.50 mm	+0.75 mm	+1.00 mm			
	020140		020141		020142			
Rings	A68RK110		A68RK111		A68RK114			
Head	220568 (Comp)	220569						
Crankshaft		140141 (Nut)						
Front end Cover								
Rear end Cover								
Conn Rod								
Bolts	140149 (4)	140138 (4)	140135 (4)	140125 (4)				
Other Parts	Front bush	Rear Bush	O Ring	Front Flange Seal		Base Plate	Gasket	
	050203	050210	BS534	010458		220097	010208	

**MAJORSELL PARTS FOR: 1194233**

**MAJORSELL REBUILD: 68A111R**



Users:	CUMMINS							
OE:	3411777	K035001						
Bore	Drive	Cooling	Weight	Mount	Lube	Water Port	Air inlet	Air delivery
86 mm	Through	Water	19 Kg	Flange	Engine oil	18 mm	26 mm	26 mm

Repair Kits	Full Kit	Head Kit	Gasket Kit	Valve Kit	Valve Plate	Cooling Plate		
	A68RK124	A68RK124A	A68RK124B	A68RK124C	A68RK115V1			
Piston	Std	+0.25 mm	+0.50 mm	+0.75 mm	+1.00 mm			
	020127	020180	020128	020188	020164			
Rings	A66RK030	A66RK081	A66RK032	A66RK082	A66RK068			
Head	220513 (Comp)	220514						
Crankshaft		140015 (Nut)						
Front end Cover								
Rear end Cover								
Conn Rod	220069							
Bolts	140102 (6)	140135 (4)	140138 (4)	140125 (8)				
Other Parts	Bushes (Front & Rear)		O Ring	O Ring	Base Plate	Gasket		
	050204		BS012V (End)	BS642V	220097 (2)	010208		



Check our web site for suitability of these and other parts, or contact us directly. Original part numbers are fitted for reference only. Check all applications. All parts offered are Majorsell brand and may not be of an original supply. Majorsell kit content and ring sets may be different to the original.

## MAJORSELL REBUILD: 68A085R

MAJORSELL PARTS FOR: 1194410

Users:	IVECO							
OE:	41211121	99971918						



Bore	Drive	Cooling	Weight	Mount	Lube	Water Port	Air inlet	Air delivery
86 mm	Through	Water	17 Kg	Flange	Engine oil	18 mm	26 mm	26 mm

Repair Kits	Full Kit	Head Kit	Gasket Kit	Valve Kit	Valve Plate	Cooling Plate	Ess Kit	Ess Kit
	A68RK115	A68RK115A	A68RK115B	A68RK115C	A68RK115V		A68RK115D	A68RK115D1
Piston	Std	+0.25 mm	+0.50 mm	+0.75 mm	+1.00 mm			
	020127	020180	020128	020188	020164			
Rings	A66RK030	A66RK081	A66RK032	A66RK082	A66RK068			
Head	220351	220452 (Comp)						
Crankshaft								
Front end Cover								
Rear end Cover								
Conn Rod	220044 (2)							
Bolts	140102 (6)	140138 (6)	140135 (4)	140125 (8)				
Other Parts	Front bush	Rear Bush	O Ring	Base Plate	Gasket			
	050269	050207	RM1250-30V	220097 (2)	010208			

\*See also LP4857 under 'Knorr Compressors'

\*68A110R (LP4857 rebuild) supersedes 68A085R (1194410 rebuild)

## MAJORSELL REBUILD: 68A132R

MAJORSELL PARTS FOR: 1194430

Users:	CUMMINS	DENNIS	TRANSBUS					
OE:	4895964	4898081	659044	658604-1				



Bore	Drive	Cooling	Weight	Mount	Lube	Water Port	Air inlet	Air delivery
86 mm	Through	Water	18 Kg	Flange	Engine oil	18 mm	26mm	26mm

Repair Kits	Full Kit	Head Kit	Gasket Kit	Valve Kit	Valve Plate	Cooling Plate		
	A68RK115	A68RK115A	A68RK115B	A68RK115C	A68RK115V1			
Piston	Std	+0.25 mm	+0.50 mm	+0.75 mm	+1.00 mm			
	020127	020180	020128	020188	020164			
Rings	A66RK030	A66RK081	A66RK032	A66RK082	A66RK068			
Head	220584	220583 (Comp)						
Crankshaft	220589	140240 (Nut)						
Front end Cover								
Rear end Cover	220591							
Conn Rod	220597 (2)							
Bolts	140102 (6)	140138 (6)	140135 (4)	140197 (8)				
Other Parts	Front bush	Rear Bearing	O Rings		Liner Sleeve	Gasket		
	050269	6207	RM1000-30V	RM0100-25V	020996 (2)	010208		



Check our web site for suitability of these and other parts, or contact us directly. Original part numbers are fitted for reference only. Check all applications. All parts offered are Majorsell brand and may not be of an original supply. Majorsell kit content and ring sets may be different to the original.

**MAJORSELL PARTS FOR: 1194456**

**MAJORSELL REBUILD: 68A111R**



Users:	CUMMINS							
OE:	3411777	K035001						
Bore	Drive	Cooling	Weight	Mount	Lube	Water Port	Air inlet	Air delivery
86 mm	Through	Water	19 Kg	Flange	Engine oil	18 mm	26 mm	26 mm

Repair Kits	Full Kit	Head Kit	Gasket Kit	Valve Kit	Valve Plate	Cooling Plate		
	A68RK124	A68RK124A	A68RK124B	A68RK124C	A68RK115V1			
Piston	Std	+0.25 mm	+0.50 mm	+0.75 mm	+1.00 mm			
	020127	020180	020128	020188	020164			
Rings	A66RK030	A66RK081	A66RK032	A66RK082	A66RK068			
Head	220513 (Comp)	220514						
Crankshaft	140015 (Nut)							
Front end Cover								
Rear end Cover								
Conn Rod	220069							
Bolts	140102 (6)	140135 (4)	140138 (4)	140125 (8)				
Other Parts	Bushes (Front & Rear)		O Ring	O Ring	Base Plate	Gasket	Gasket	Gasket
	050204		BS012V	BS642V	220097 (2)	010208	010097	010094

**MAJORSELL PARTS FOR: 5001869**

**MAJORSELL REBUILD: 68A159R**



Users:								
OE:								
Bore	Drive	Cooling	Weight	Mount	Lube	Water Port	Air inlet	Air delivery
2.78"	Through	Water	26 Kg	Flange	Engine oil	1/2"	MANIFOLD	MANIFOLD

Repair Kits	Full Kit	Head Kit	Gasket Kit	Valve Kit	Valve Plate	Cooling Plate		
	A68RK096	A68RK096A						
Piston	Std	+0.25 mm	+0.50 mm	+0.75 mm	+1.00 mm			
	020106	020107	020108	020109	020110			
Rings	A68RK097	A68RK098	A68RK099	A68RK100	A68RK101			
Head								
Crankshaft								
Front end Cover								
Rear end Cover								
Conn Rod								
Bolts	140163 (6)	140159 (4)	140159 (7)	140193 (6)				
Other Parts	Rear bush	Inserts	Base Gasket					
	050064	050171 (2)	010092					



Check our web site for suitability of these and other parts, or contact us directly. Original part numbers are fitted for reference only. Check all applications. All parts offered are Majorsell brand and may not be of an original supply. Majorsell kit content and ring sets may be different to the original.

**MAJORSELL REBUILD: 68A078R**

**MAJORSELL PARTS FOR: 5012532**

Users:	CAT							
OE:	223-3636	5012533						



Bore	Drive	Cooling	Weight	Mount	Lube	Water Port	Air inlet	Air delivery
92 mm	Non through	Water	21 Kg	Flange	Engine oil	16 mm	26 mm	18 mm

Repair Kits	Full Kit	Head Kit	Gasket Kit	Valve Kit	Valve Plate	Cooling Plate	Ess Kit	
	A66RK058	A66RK058A	A66RK058B	A66RK058C	A66RK058V	A66RK058CP	A66RK058D	
Piston	Std	+0.25 mm	+0.50 mm	+0.75 mm	+1.00 mm			
	020158	020182	020159	020207	020160			
Rings	A66RK060	A66RK086	A66RK061	A66RK087	A66RK062			
Head	220750 (Comp)	220749						
Crankshaft	220748	140323 (Nut)						
Front end Cover								
Rear end Cover	220751							
Conn Rod	220682							
Bolts	140135 (4)	140134 (4)						
Other Parts	Front bush	Rear Bearing	Base Plate					
	050206	6308	220271					

**MAJORSELL REBUILD: 68A002R**

**MAJORSELL PARTS FOR: KZ433**

Users:	VOLVO	ERF	LEYLAND					
OE:	1612335	15705940	1590264	5001711	5001608	1367537R	EBBU5551	



Bore	Drive	Cooling	Weight	Mount	Lube	Water Port	Air inlet	Air delivery
75 mm	Non through	Water	23 Kg	Flange	Engine oil	3/8"	Flange	Flange

Repair Kits	Universal Kit	Service Kit	Gasket Kit	Valve Kit	Valve Plate	Cooling Plate	Filter Kit	
	A68RK094	A68RK006A	A68RK006B		220007		A68RK006F	
Piston	Std	+0.010"	+0.020"	+0.030"	+0.040"			
	020011	020012	020013	020014	020088			
Rings	A68RK024	A68RK025	A68RK026	A68RK027	A68RK095			
Head	220006							
Crankshaft	220008	140014 (Nut)	090004 (Key)					
Front end Cover								
Rear end Cover	220009							
Conn Rod	220019							
Bolts	140120 (11)	140126 (2)	140124 (3)	140103 (3)	140125 (10)	140125 (8)		
Other Parts	Front bearing	Rear bush	Bearing Circlip	O Ring	Valve Seat	Base Plate	Base Plate	Base Plate
	6207	050049	130010	RM1150-30V	060142 (2)	220097	220098	220594



Check our web site for suitability of these and other parts, or contact us directly. Original part numbers are fitted for reference only. Check all applications. All parts offered are Majorsell brand and may not be of an original supply. Majorsell kit content and ring sets may be different to the original.

**MAJORSELL PARTS FOR: KZ642**

**MAJORSELL REBUILD: 68A001R**



Users:	SCANIA	ERF	DAF					
OE:	571043	300162	136751-4R	BBU7608				
Bore	Drive	Cooling	Weight	Mount	Lube	Water Port	Air inlet	Air delivery
75 mm	Non through	Water	19 Kg	Flange	Engine oil	18 mm	Flange	Flange

Repair Kits	Full Kit	Head Kit	Gasket Kit	Valve Kit	Valve Plate	Cooling Plate	Filter Kit	
	A68RK094	A68RK006A	A68RK006B		220020		A68RK006F	
Piston	Std	+0.010"	+0.020"	+0.030"	+0.040"			
	020011	020012	020013	020014	020088			
Rings	A68RK024	A68RK025	A68RK026	A68RK027	A68RK095			
Head	220021							
Crankshaft	220008	140014 (Nut)	090004 (Key)					
Front end Cover								
Rear end Cover	220009							
Conn Rod	220019							
Bolts	140120 (10)	140126 (2)	140124 (6)	140103 (6)	140125 (10)			
Other Parts	Front bearing	Rear bush	Bearing Circlip	O Ring	Valve Seat	Sump cover		
	6207	050049	130010	RM1150-30V	060142 (2)	220430		

**MAJORSELL PARTS FOR: KZ800**

**MAJORSELL REBUILD: 68A027R**



Users:	IVECO	CARGO	FORD					
OE:	81DB2875DE	82DB2875AC						
Bore	Drive	Cooling	Weight	Mount	Lube	Water Port	Air inlet	Air delivery
75 mm	Non through	Air	10 Kg	Flange	Engine oil		3/8"	3/8"

Repair Kits	Full Kit	Head Kit	Gasket Kit	Valve Kit	Valve Plate	Cooling Plate		
	A68RK040A		A68RK040B					
Piston	Std	+0.010"	+0.020"	+0.030"	+0.040"			
	020011	020012	020013	020014	020088			
Rings	A68RK010	A68RK011	A68RK012	A68RK013	A68RK095			
Head								
Crankshaft	140141 (Nut)							
Front end Cover								
Rear end Cover								
Conn Rod								
Bolts	140288 (4)	140103 (4)	140124 (4)	140103 (4)	140154 (4)			
Other Parts	Front bush	Rear Bush	Thrust Washer	O Ring				
	050179	050049	050191	BS041				



Check our web site for suitability of these and other parts, or contact us directly. Original part numbers are fitted for reference only. Check all applications. All parts offered are Majorsell brand and may not be of an original supply. Majorsell kit content and ring sets may be different to the original.

## MAJORSELL REBUILD: 68A105R

## MAJORSELL PARTS FOR: KZ801

Users:	IVECO	CARGO	FORD					
OE:								



Bore	Drive	Cooling	Weight	Mount	Lube	Water Port	Air inlet	Air delivery
75 mm	Through	Air	10 Kg	Flange	Engine oil		3/8"	3/8"

Repair Kits	Full Kit	Head Kit	Gasket Kit	Valve Kit	Valve Plate	Cooling Plate		
	A68RK040A		A68RK040B					
Piston	Std	+0.010"	+0.020"	+0.030"	+0.040"			
	020011	020012	020013	020014	020088			
Rings	A68RK010	A68RK011	A68RK012	A68RK013	A68RK095			
Head								
Crankshaft		140141 (Nut)						
Front end Cover								
Rear end Cover								
Conn Rod								
Bolts	140288 (4)	140103 (4)	140135 (4)	140154 (4)	140103 (4)			
Other Parts	Front bush	Rear Bush	Thrust Washer	O Ring				
	050179	050049	050191	BS041				

## MAJORSELL REBUILD: 68A015R

## MAJORSELL PARTS FOR: KZ803

Users:	IVECO	CARGO	FORD					
OE:	81DB2875EE							



Bore	Drive	Cooling	Weight	Mount	Lube	Water Port	Air inlet	Air delivery
85.7 mm	Through	Water	12 Kg	Flange	Engine oil	3/8"	3/4"	1/2"

Repair Kits	Full Kit	Head Kit	Gasket Kit	Valve Kit	Valve Plate	Cooling Plate		
	A68RK040A		A68RK040B		A68RK040V			
Piston	Std	+0.010"	+0.020"	+0.030"				
	020084	020085	020086	020087				
Rings	A68RK087	A68RK088	A68RK089	A68RK090				
Head								
Crankshaft	140141 (Nut)							
Front end Cover								
Rear end Cover								
Conn Rod								
Bolts	140102 (4)	140135 (4)	140154 (4)					
Other Parts	Front bush	Rear Bush	Thrust Washer	O Ring				
	050179	050049	050191	BS041				



Check our web site for suitability of these and other parts, or contact us directly. Original part numbers are fitted for reference only. Check all applications. All parts offered are Majorsell brand and may not be of an original supply. Majorsell kit content and ring sets may be different to the original.

**MAJORSELL PARTS FOR: KZ996**

**MAJORSELL REBUILD: 68A007R**



Users:	SCANIA							
OE:	1189107	KZ996-2	301525	571044	1314107			
Bore	Drive	Cooling	Weight	Mount	Lube	Water Port	Air inlet	Air delivery
75 mm	Non through	Water	23 Kg	Flange	Engine oil	16 mm	Manifold	Manifold

Repair Kits	Universal Kit	Service Kit	Gasket Kit	Valve Kit	Valve Plate	Cooling Plate		
	A68RK094	A68RK006A	A68RK006B		220020			
Piston	Std	+0.010"	+0.020"	+0.030"	+0.040"			
	020011	020012	020013	020014	020088			
Rings	A68RK024	A68RK025	A68RK026	A68RK027	A68RK095			
Head	220184							
Crankshaft	220008	140014 (Nut)	090004 (Key)					
Front end Cover								
Rear end Cover	220009							
Conn Rod	220019							
Bolts	140120 (10)	140126 (2)	140124 (3)	140103 (3)	140125 (10)			
Other Parts	Front Bearing	Rear Bush	Bearing Circlip	O Ring	Valve Seat	Sump cover		
	6207	050049	130010	RM1150-30V	060142 (2)	220430		

**MAJORSELL PARTS FOR: KZ1087**

**MAJORSELL REBUILD: 68A119R**



Users:	GARDNER	DENNIS						
OE:	L29274	653926						
Bore	Drive	Cooling	Weight	Mount	Lube	Water Port	Air inlet	Air delivery
75 mm	Non through	Water	19 Kg	Base	Engine oil	½"	¾"	¾"

Repair Kits	Full Kit	Head Kit	Gasket Kit	Valve Kit	Valve Plate	Cooling Plate		
	A68RK103	A68RK103A	A68RK103B	A68RK103C	A68RK103V			
Piston	Std	+0.25 mm	+0.50 mm	+0.75 mm	+1.00 mm			
	020011	020012	020013	020014	020088			
Rings	A68RK024	A68RK025	A68RK026	A68RK027	A68RK095			
Head	220574 (Comp)	220575						
Crankshaft			190004 (Key)					
Front end Cover								
Rear end Cover								
Conn Rod	220055 (2)							
Bolts	140124 (3)	140124 (3)						
Other Parts	Front bearing	Rear Bush	Sump Gasket	Oil Seal				
	6307	050203	010240	110004				



Check our web site for suitability of these and other parts, or contact us directly. Original part numbers are fitted for reference only. Check all applications. All parts offered are Majorsell brand and may not be of an original supply. Majorsell kit content and ring sets may be different to the original.



**MAJORSELL REBUILD: 68A069R**

**MAJORSELL PARTS FOR: KZ1114**

Users:	DAF	CUMMINS						
OE:	CBU1206	3906251						



Bore	Drive	Cooling	Weight	Mount	Lube	Water Port	Air inlet	Air delivery
75 mm	Through	Air	10.5 Kg	Flange	Engine oil		3/4"	1/2"

Repair Kits	Service Kit	Head Kit	Gasket Kit	Valve Kit	Valve Plate	Cooling Plate		
	A68RK092A		A68RK092B		A68RK092V			
Piston	Std	+0.25 mm	+0.50 mm	+0.75 mm	+1.00 mm			
	020011	020012	020013	020014	020015			
Rings	A68RK010	A68RK011	A68RK012	A68RK013	A68RK095			
Head								
Crankshaft	140240 (Nut)							
Front end Cover								
Rear end Cover								
Conn Rod								
Bolts	140125 (4)							
Other Parts	Front bush	Rear Bush	Locking Tab	Front Flange Seal		Base Plate	Gasket	
	050203	050211	050008	010458		220097	010208	

**MAJORSELL REBUILD: 68A074R**

**MAJORSELL PARTS FOR: KZ1115-2**

Users:								
OE:								



Bore	Drive	Cooling	Weight	Mount	Lube	Water Port	Air inlet	Air delivery
75 mm	Through	Water	10 Kg	Flange	Engine oil	3/8"	3/4"	1/2"

Repair Kits	Full Kit	Head Kit	Gasket Kit	Valve Kit	Valve Plate	Cooling Plate		
		A68RK104A	A68RK104B	A68RK104C	A68RK104V1			
Piston	Std	+0.25 mm	+0.50 mm	+0.75 mm	+1.00 mm			
	020011	020012	020013	020014	020088			
Rings	A68RK010	A68RK011	A68RK012	A68RK013	A68RK095			
Head								
Crankshaft		140014 (Nut)						
Front end Cover								
Rear end Cover								
Conn Rod	220019							
Bolts	140102 (4)	140125 (4)	140135 (4)					
Other Parts	Front Bush	Rear Bush	Base Plate					
	050203	050211	220097					



Check our web site for suitability of these and other parts, or contact us directly. Original part numbers are fitted for reference only. Check all applications. All parts offered are Majorsell brand and may not be of an original supply. Majorsell kit content and ring sets may be different to the original.

**MAJORSELL PARTS FOR: KZ1143**

**MAJORSELL REBUILD: 68A016R**



Users:	DENNIS	CUMMINS	DAF					
OE:	3282836	3279087	3906255					
Bore	Drive	Cooling	Weight	Mount	Lube	Water Port	Air inlet	Air delivery
80 mm	Through	Water	13 Kg	Flange	Engine oil	3/8"	3/4"	1/2"

Repair Kits	Service Kit	Head Kit	Gasket Kit	Valve Kit	Valve Plate	Cooling Plate		
	A68RK092A		A68RK092B		A68RK092V			
Piston	Std	+0.25 mm	+0.50 mm	+0.75 mm	+1.00 mm			
	020140		020141		020142			
Rings	A68RK110		A68RK111		A68RK114			
Head	220677 (Comp)	220678						
Crankshaft	220679	140240 (Nut)						
Front end Cover								
Rear end Cover	220680							
Conn Rod	220676							
Bolts	140102 (4)	140125 (4)	140150 (4)					
Other Parts	Bushes (Front & Rear)		Front Flange Ring	Thrust Washer		Base Plate	Gasket	
	050203		010458	050008 (2)		220097	010208	

**MAJORSELL PARTS FOR: KZ1265-2**

**MAJORSELL REBUILD: 68A101R**



Users:	FODEN							
OE:	WDKZ12652							
Bore	Drive	Cooling	Weight	Mount	Lube	Water Port	Air inlet	Air delivery
80 mm	Non through	Water	12 Kg	Base	Engine oil	1/2"	3/4"	1/2"

Repair Kits	Service Kit	Head Kit	Gasket Kit	Valve Kit	Valve Plate	Cooling Plate		
	A68RK105A		A68RK105B	A68RK105C	A68RK105V			
Piston	Std	+0.25 mm	+0.50 mm	+0.75 mm	+1.00 mm			
	020140		020141		020142			
Rings	A68RK110		A68RK111		A68RK114			
Head								
Crankshaft			090004 (Key)					
Front end Cover								
Rear end Cover								
Conn Rod								
Bolts	140102 (4)	140138 (4)	140135 (4)					
Other Parts	Front Bearing	Rear Bush	Thrust Washer	Oil Seal				
	2NU07	050203	050026	110040				



Check our web site for suitability of these and other parts, or contact us directly. Original part numbers are fitted for reference only. Check all applications. All parts offered are Majorsell brand and may not be of an original supply. Majorsell kit content and ring sets may be different to the original.



**MAJORSELL PARTS FOR: 3035673**

**MAJORSELL REBUILD: 74A010R**



Users:	CUMMINS							
OE:								
Bore	Drive	Cooling	Weight	Mount	Lube	Water Port	Air inlet	Air delivery
3 5/8"	Through	Water	20 Kg	Flange	Engine oil	3/8"	Manifold	1/2"

Repair Kits	Full Kit	Head Kit	Gasket Kit	Valve Kit	Valve Plate	Cooling Plate	Unloader Kit	
	A74RK002A		A74RK010				A74RK001A	
Piston	Std	+0.010"	+0.020"	+0.030"	+0.040"			
	020048	020049	020050	020051	020052			
Rings	A74RK003	A74RK004	A74RK005	A74RK006	A74RK007			
Head	220615 (Cover)							
Crankshaft								
Front end Cover	220616							
Rear end Cover								
Conn Rod	220024							
Bolts	140173 (4)	140157 (4)	140174 (4)	140175 (4)				
Other Parts	Rear Bush	Bearing Thrust	Gasket					
	050053	050156	010197					

**MAJORSELL PARTS FOR: 3047440**

**MAJORSELL REBUILD: 74A003R**



Users:	CUMMINS							
OE:	3275536	3277555	3035673	3035674				
Bore	Drive	Cooling	Weight	Mount	Lube	Water Port	Air inlet	Air delivery
3 5/8"	Through	Water	20 Kg	Flange	Engine oil	3/8"	Manifold	1/2"

Repair Kits	Full Kit	Head Kit	Gasket Kit	Valve Kit	Valve Plate	Cooling Plate	Unloader Kit	
	A74RK002A		A74RK010		A74RK002V		A74RK001A	
Piston	Std	+0.010"	+0.020"	+0.030"	+0.040"			
	020048	020049	020050	020051	020052			
Rings	A74RK003	A74RK004	A74RK005	A74RK006	A74RK007			
Head	220615 (Cover)							
Crankshaft								
Front end Cover	220616							
Rear end Cover								
Conn Rod	220024							
Bolts	140173 (4)	140157 (4)	140174 (4)	140175 (4)				
Other Parts	Rear Bush	Liner Sleeve	Thrust Washer	Cover Gasket	Mount Gasket	Flange Gasket		
	050053	020998	050156	010161	010097	010094		



Check our web site for suitability of these and other parts, or contact us directly. Original part numbers are fitted for reference only. Check all applications. All parts offered are Majorsell brand and may not be of an original supply. Majorsell kit content and ring sets may be different to the original.

**MAJORSELL REBUILD:**

**MAJORSELL PARTS FOR: 3048672**

Users:	CUMMINS							
OE:	199654	3025827						



Bore	Drive	Cooling	Weight	Mount	Lube	Water Port	Air inlet	Air delivery
		Water		Flange				

Repair Kits	Full Kit	Service Kit	Gasket Kit	Valve Kit	Valve Plate	Cooling Plate		
	A74RK016	A74RK012						
Piston	Std	+0.010"	+0.020"	+0.030"	+0.040"			
	020048	020049	020050	020051	020052			
Rings	A74RK003	A74RK004	A74RK005	A74RK006	A74RK007			
Head								
Crankshaft								
Front end Cover								
Rear end Cover								
Conn Rod								
Bolts								
Other Parts	Front bush	Rear Bush	Thrust Washer	Sump Gasket	Gaskets			
	050050	050053	050146	010215	010097 (Cover)	010177 (Cover)	010349 (Flange)	

**MAJORSELL REBUILD:**

**MAJORSELL PARTS FOR: 3048673**

Users:	CUMMINS							
OE:	199654	3025827						



Bore	Drive	Cooling	Weight	Mount	Lube	Water Port	Air inlet	Air delivery
		Water		Flange				

Repair Kits	Full Kit	Service Kit	Gasket Kit	Valve Kit	Valve Plate	Cooling Plate		
	A74RK016	A74RK012						
Piston	Std	+0.010"	+0.020"	+0.030"	+0.040"			
	020048	020049	020050	020051	020052			
Rings	A74RK003	A74RK004	A74RK005	A74RK006	A74RK007			
Head								
Crankshaft								
Front end Cover								
Rear end Cover								
Conn Rod								
Bolts								
Other Parts	Rear bush	Front Cover Gasket	Sump Gasket	Flange Gasket				
	050053	010161	010215	010349				



Check our web site for suitability of these and other parts, or contact us directly. Original part numbers are fitted for reference only. Check all applications. All parts offered are Majorsell brand and may not be of an original supply. Majorsell kit content and ring sets may be different to the original.

**MAJORSELL PARTS FOR: 3048675**

**MAJORSELL REBUILD:**

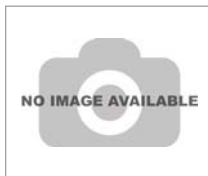

Users:	CUMMINS							
OE:	AR11495	3017048	3025832					
Bore	Drive	Cooling	Weight	Mount	Lube	Water Port	Air inlet	Air delivery
		Water		Flange				

Repair Kits	Full Kit	Service Kit	Gasket Kit	Valve Kit	Valve Plate	Cooling Plate		
	A74RK016	A74RK012						
Piston	Std	+0.010"	+0.020"	+0.030"	+0.040"			
	020048	020049	020050	020051	020052			
Rings	A74RK003	A74RK004	A74RK005	A74RK006	A74RK007			
Head								
Crankshaft								
Front end Cover								
Rear end Cover								
Conn Rod								
Bolts								
Other Parts	Front bush	Rear Bush	Thrust Washer		Sump Gasket	Front Cover Gasket		
	050050	050053	050146	050156	010215	010177		

**MAJORSELL PARTS FOR: 3048677**

**MAJORSELL REBUILD: 74A017R**



Users:	CUMMINS							
OE:								
Bore	Drive	Cooling	Weight	Mount	Lube	Water Port	Air inlet	Air delivery
3 5/8"	Through	Water	36 Kg	Flange	Engine oil	3/8"	Flange	3/4"

Repair Kits	Full Kit	Head Kit	Gasket Kit	Valve Kit	Valve Plate	Cooling Plate		
	A74RK016	A74RK012						
Piston	Std	+0.010"	+0.020"	+0.030"	+0.040"			
	020048	020049	020050	020051	020052			
Rings	A74RK003	A74RK004	A74RK005	A74RK006	A74RK007			
Head								
Crankshaft								
Front end Cover								
Rear end Cover								
Conn Rod	220330 (2)							
Bolts	140217 (8)	140175 (10)	140174 (2)	140175 (6)	140190 (3)	140175 (3)		
Other Parts	Front Bush	Rear Bush	Thrust Washer	Cylinder Liner				
	050050	050053	050146	020998				



Check our web site for suitability of these and other parts, or contact us directly. Original part numbers are fitted for reference only. Check all applications. All parts offered are Majorsell brand and may not be of an original supply. Majorsell kit content and ring sets may be different to the original.

**MAJORSELL REBUILD:**

**MAJORSELL PARTS FOR: 3048680**

Users:	CUMMINS							
OE:								
Bore	Drive	Cooling	Weight	Mount	Lube	Water Port	Air inlet	Air delivery
		Water		Flange				



Repair Kits	Full Kit	Service Kit	Gasket Kit	Valve Kit	Valve Plate	Cooling Plate		
	A74RK016	A74RK012						
Piston	Std	+0.010"	+0.020"	+0.030"	+0.040"			
	020048	020049	020050	020051	020052			
Rings	A74RK003	A74RK004	A74RK005	A74RK006	A74RK007			
Head								
Crankshaft								
Front end Cover								
Rear end Cover								
Conn Rod								
Bolts								
Other Parts	Front bush	Rear Bush	Thrust Washer		Sump Gasket	Gasket	Gasket	
	050050	050053	050146	050156	010215	010177	010097	

**MAJORSELL REBUILD: 74A011R**

**MAJORSELL PARTS FOR: 3049186**

Users:	CUMMINS							
OE:								
Bore	Drive	Cooling	Weight	Mount	Lube	Water Port	Air inlet	Air delivery
3 5/8"	Through	Water	20 Kg	Flange	Engine oil	3/8"	Manifold	1/2"



Repair Kits	Full Kit	Head Kit	Gasket Kit	Valve Kit	Valve Plate	Cooling Plate	Unloader Kit	
	A74RK002A		A74RK010				A74RK001A	
Piston	Std	+0.010"	+0.020"	+0.030"	+0.040"			
	020048	020049	020050	020051	020052			
Rings	A74RK003	A74RK004	A74RK005	A74RK006	A74RK007			
Head	220615 (Cover)							
Crankshaft								
Front end Cover	220616							
Rear end Cover								
Conn Rod	220024							
Bolts	140173 (4)	140157 (4)	140174 (4)	140175 (4)				
Other Parts	Rear Bush	Bearing Thrust	Gasket					
	050053	050156	010197					



Check our web site for suitability of these and other parts, or contact us directly. Original part numbers are fitted for reference only. Check all applications. All parts offered are Majorsell brand and may not be of an original supply. Majorsell kit content and ring sets may be different to the original.

**MAJORSELL PARTS FOR: 3558006**

**MAJORSELL REBUILD: 74A001R**



Users:	CUMMINS							
OE:								
Bore	Drive	Cooling	Weight	Mount	Lube	Water Port	Air inlet	Air delivery
3 5/8"	Non Through	Water	20 Kg	Flange	Engine oil	3/8"	Flange	1/2"

Repair Kits	Full Kit	Head Kit	Gasket Kit	Valve Kit	Valve Plate	Cooling Plate	Unloader Kit		
	A74RK002A		A74RK010				A74RK001A		
Piston	Std	+0.010"	+0.020"	+0.030"	+0.040"				
	020048	020049	020050	020051	020052				
Rings	A74RK003	A74RK004	A74RK005	A74RK006	A74RK007				
Head	220615 (Cover)								
Crankshaft									
Front end Cover	220663								
Rear end Cover									
Conn Rod	220024								
Bolts	140173 (4)	140157 (4)	140174 (4)	140175 (4)					
Other Parts	Rear Bush	Thrust Washer	Liner Sleeve	Gaskets					
	050053	050156	020998	010161 (Inn)	010438 (Inn)	010361 (Out)	010444 (Flange)		

**MAJORSELL PARTS FOR: 3558013**

**MAJORSELL REBUILD: 74A018R**



Users:	CUMMINS							
OE:	3558211							
Bore	Drive	Cooling	Weight	Mount	Lube	Water Port	Air inlet	Air delivery
3 7/8"	Through	Water	20 Kg	Flange	Engine oil	3/8"	Manifold	1/2"

Repair Kits	Full Kit	Head Kit	Gasket Kit	Valve Kit	Valve Plate	Cooling Plate	Unloader Kit	
	A74RK002A		A74RK010		A74RK002V		A74RK001A	
Piston	Std	+0.25 mm	+0.50 mm	+0.75 mm	+1.00 mm			
	020090		020092		020093			
Rings	A74RK013		A74RK015		A74RK018			
Head	220615 (Cover)							
Crankshaft								
Front end Cover	220616							
Rear end Cover								
Conn Rod	220024							
Bolts	140173 (4)	140157 (4)	140174 (4)	140175 (4)				
Other Parts	Rear Bearing	Thrust Washer	Gasket	Gasket	Gasket	Gasket		
	050053	050156	010448 (Head)	010438 (Rear)	010097 (Mount)	010161 (Flange)		



Check our web site for suitability of these and other parts, or contact us directly. Original part numbers are fitted for reference only. Check all applications. All parts offered are Majorsell brand and may not be of an original supply. Majorsell kit content and ring sets may be different to the original.



**MAJORSELL REBUILD: 74A002R**

**MAJORSELL PARTS FOR: 3558059**

Users:	CUMMINS							
OE:								



Bore	Drive	Cooling	Weight	Mount	Lube	Water Port	Air inlet	Air delivery
3 5/8"	Through	Water	21 Kg	Flange	Engine oil	3/4"	Manifold	1/2"

Repair Kits	Full Kit	Head Kit	Gasket Kit	Valve Kit	Valve Plate	Cooling Plate	Unloader Kit	
	A74RK017	A74RK017A	A74RK017B	A74RK017C	A74RK017V	A74RK017CP	A74RK017D	
Piston	Std	+0.010"	+0.020"	+0.030"	+0.040"			
	020048	020049	020050	020051	020052			
Rings	A74RK003	A74RK004	A74RK005	A74RK006	A74RK007			
Head	220512 (Comp)							
Crankshaft								
Front end Cover	220616							
Rear end Cover								
Conn Rod	220024							
Bolts	140191 (4)	140174 (4)	140175 (4)					
Other Parts	Front Bush	Rear Bush	Gaskets		Liner Sleeve			
	050050	050053	010161 (Inn)	010097 (Front)	020998			

**MAJORSELL REBUILD: 74A005R**

**MAJORSELL PARTS FOR: 3558072**

Users:	CUMMINS							
OE:	3558072							



Bore	Drive	Cooling	Weight	Mount	Lube	Water Port	Air inlet	Air delivery
3 5/8"	Through	Water	21 Kg	Flange	Engine oil	3/4"	Manifold	1/2"

Repair Kits	Full Kit	Head Kit	Gasket Kit	Valve Kit	Valve Plate	Cooling Plate	Unloader Kit	
	A74RK017	A74RK017A	A74RK017B	A74RK017C	A74RK017V	A74RK017CP	A74RK017D	
Piston	Std	+0.010"	+0.020"	+0.030"	+0.040"			
	020048	020049	020050	020051	020052			
Rings	A74RK003	A74RK004	A74RK005	A74RK006	A74RK007			
Head	220512 (Comp)							
Crankshaft								
Front end Cover	220616							
Rear end Cover								
Conn Rod	220024							
Bolts	140191 (4)	140175 (4)						
Other Parts	Rear Bush	Liner Sleeve						
	050053	020998						



Check our web site for suitability of these and other parts, or contact us directly. Original part numbers are fitted for reference only. Check all applications. All parts offered are Majorsell brand and may not be of an original supply. Majorsell kit content and ring sets may be different to the original.

**MAJORSELL PARTS FOR: 3558097**

**MAJORSELL REBUILD: 74A007R**



Users:	CUMMINS							
OE:								
Bore	Drive	Cooling	Weight	Mount	Lube	Water Port	Air inlet	Air delivery
3 5/8"	Non through	Water	21 Kg	Flange	Engine oil	3/4"	Manifold	1/2"

Repair Kits	Full Kit	Head Kit	Gasket Kit	Valve Kit	Valve Plate	Cooling Plate	Unloader Kit	
	A74RK017	A74RK017A	A74RK017B	A74RK017C	A74RK017V	A74RK017CP	A74RK017D	
Piston	Std	+0.010"	+0.020"	+0.030"	+0.040"			
	020048	020049	020050	020051	020052			
Rings	A74RK003	A74RK004	A74RK005	A74RK006	A74RK007			
Head	220512 (Comp)							
Crankshaft								
Front end Cover								
Rear end Cover								
Conn Rod	220024							
Bolts	140191 (4)	140175 (4)						
Other Parts	Rear Bush	Gasket	Gasket	Liner Sleeve	Front Flange Gasket			
	050053	010444 (Flange)	010361 (Out)	020998	3929751			

**MAJORSELL PARTS FOR: 3558098**

**MAJORSELL REBUILD: 74A009R**



Users:	CUMMINS							
OE:	3558097							
Bore	Drive	Cooling	Weight	Mount	Lube	Water Port	Air inlet	Air delivery
3 5/8"	Non through	Water		Flange	Engine oil	3/4"	Manifold	1/2"

Repair Kits	Full Kit	Head Kit	Gasket Kit	Valve Kit	Valve Plate	Cooling Plate	Unloader Kit	
	A74RK017	A74RK017A	A74RK017B	A74RK017C	A74RK017V	A74RK017CP	A74RK017D	
Piston	Std	+0.010"	+0.020"	+0.030"	+0.040"			
	020048	020049	020050	020051	020052			
Rings	A74RK003	A74RK004	A74RK005	A74RK006	A74RK007			
Head								
Crankshaft								
Front end Cover								
Rear end Cover								
Conn Rod								
Bolts								
Other Parts	Front Flange Gasket							
	3929751							



Check our web site for suitability of these and other parts, or contact us directly. Original part numbers are fitted for reference only. Check all applications. All parts offered are Majorsell brand and may not be of an original supply. Majorsell kit content and ring sets may be different to the original.

## MAJORSELL REBUILD: 74A019R

MAJORSELL PARTS FOR: 3558113

Users:	CUMMINS							
OE:								
Bore	Drive	Cooling	Weight	Mount	Lube	Water Port	Air inlet	Air delivery
3. 7/8"	Through	Water	21 Kg	Flange	Engine oil	3/4"	Manifold	1/2"



Repair Kits	Full Kit	Head Kit	Gasket Kit	Valve Kit	Valve Plate	Cooling Plate	Ess Kit	
	A74RK017	A74RK017A	A74RK017B	A74RK017C	A74RK017V	A74RK017CP	A74RK017D	
Piston	Std	+0.20 mm	+0.30 mm	+0.40 mm	+0.50 mm			
	020090	020092	020093					
Rings	A74RK013	A74RK015	A74RK018					
Head	220512 (Comp)							
Crankshaft								
Front end Cover								
Rear end Cover								
Conn Rod	220024							
Bolts	140191 (4)	140174 (4)	140175 (6)	140158 (2)	140147 (4)			
Other Parts	Rear Bush	Gasket	Gasket	Gasket	Gasket			
	050053	010445	010438	010161	010361			

## MAJORSELL REBUILD: 74A012R

MAJORSELL PARTS FOR: 3558182

Users:	CUMMINS							
OE:								
Bore	Drive	Cooling	Weight	Mount	Lube	Water Port	Air inlet	Air delivery
3 5/8"	Through	Water		Flange	Engine oil	3/8"	Manifold	1/2"



Repair Kits	Full Kit	Head Kit	Gasket Kit	Valve Kit	Valve Plate	Cooling Plate	Unloader Kit	
	A74RK017	A74RK017A	A74RK017B	A74RK017C	A74RK017V	A74RK017CP	A74RK017D	
Piston	Std	+0.010"	+0.020"	+0.030"	+0.040"			
	020048	020049	020050	020051	020052			
Rings	A74RK003	A74RK004	A74RK005	A74RK006	A74RK007			
Head	220512 (Comp)							
Crankshaft								
Front end Cover								
Rear end Cover								
Conn Rod	220024							
Bolts	140191 (4)	140174 (4)	140175 (4)					
Other Parts	Rear Bush	Gasket	Liner Sleeve					
	050053	010445	020998					



Check our web site for suitability of these and other parts, or contact us directly. Original part numbers are fitted for reference only. Check all applications. All parts offered are Majorsell brand and may not be of an original supply. Majorsell kit content and ring sets may be different to the original.

**MAJORSELL PARTS FOR: 3558211**

**MAJORSELL REBUILD: 74A008R**



Users:	CUMMINS							
OE:								
Bore	Drive	Cooling	Weight	Mount	Lube	Water Port	Air inlet	Air delivery
3 5/8"	Through	Water	21 Kg	Flange	Engine oil	3/4"	Manifold	1/2"

Repair Kits	Full Kit	Head Kit	Gasket Kit	Valve Kit	Valve Plate	Cooling Plate	Unloader Kit	
	A74RK017	A74RK017A	A74RK017B	A74RK017C	A74RK017V	A74RK017CP	A74RK017D	
Piston	Std	+0.010"	+0.020"	+0.030"	+0.040"			
	020048	020049	020050	020051	020052			
Rings	A74RK003	A74RK004	A74RK005	A74RK006	A74RK007			
Head	220512 (Comp)							
Crankshaft								
Front end Cover								
Rear end Cover	220040							
Conn Rod	220024							
Bolts	140191 (4)	140175 (4)						
Other Parts	Rear Bush	Gasket	Liner Sleeve	Front Flange Gasket				
	050053	010445	020998	3929751				

**MAJORSELL PARTS FOR: 3558212**

**MAJORSELL REBUILD: 74A006R**



Users:	CUMMINS							
OE:								
Bore	Drive	Cooling	Weight	Mount	Lube	Water Port	Air inlet	Air delivery
3. 7/8"	Through	Water	21 Kg	Flange	Engine oil	3/4"	Manifold	1/2"

Repair Kits	Full Kit	Head Kit	Gasket Kit	Valve Kit	Valve Plate	Cooling Plate	Unloader Kit	
	A74RK017	A74RK017A	A74RK017B	A74RK017C	A74RK017V	A74RK017CP	A74RK017D	
Piston	Std	+0.010"	+0.020"	+0.030"	+0.040"			
	020090		020092	020093				
Rings	A74RK013		A74RK015	A74RK018				
Head	220512 (Comp)							
Crankshaft								
Front end Cover								
Rear end Cover	220040							
Conn Rod	220024							
Bolts	140191 (4)	140174 (4)	140175 (4)					
Other Parts	Rear Bush	Gasket		Front Flange Gasket				
	050053	010445	010361 (Out)	3929751				



Check our web site for suitability of these and other parts, or contact us directly. Original part numbers are fitted for reference only. Check all applications. All parts offered are Majorsell brand and may not be of an original supply. Majorsell kit content and ring sets may be different to the original.



**MAJORSELL PARTS FOR: KN7070**

**MAJORSELL REBUILD:**



Users:	CAT							
OE:								
Bore	Drive	Cooling	Weight	Mount	Lube	Water Port	Air inlet	Air delivery
	Non-through	Water		Flange				

Repair Kits	Full Kit	Head Kit	Gasket Kit	Valve Kit	Valve Plate	Cooling Plate	Unloader Kit	
	A73RK015						A73RK014	
Piston	Std	+0.010"	+0.020"	+0.030"	+0.040"			
	020078	020079	020080	020081	020082			
Rings	A73RK016	A73RK017	A73RK018	A73RK019	A73RK020			
Head								
Crankshaft								
Front end Cover								
Rear end Cover								
Conn Rod								
Bolts								
Other Parts	Inserts							
	050027 (2)							

**MAJORSELL PARTS FOR: KN13040**

**MAJORSELL REBUILD: 73A003R**



Users:	CUMMINS							
OE:								
Bore	Drive	Cooling	Weight	Mount	Lube	Water Port	Air inlet	Air delivery
2 3/4"	Through	Water	15 Kg	Flange				

Repair Kits	Full Kit	Head Kit	Gasket Kit	Valve Kit	Valve Plate	Cooling Plate		
	A73RK001	A73RK001A	A73RK001B	A73RK001C				
Piston	Std	+0.010"	+0.020"	+0.030"	+0.040"			
	020018	020019	020020	020021	020022			
Rings	A73RK002	A73RK003	A73RK004	A73RK005	A73RK006			
Head								
Crankshaft								
Front end Cover								
Rear end Cover								
Conn Rod	220037							
Bolts								
Other Parts	Roller Bearing	Front Bush	Inserts	Plunger				
	6011	050137	050027 (2)	210054				



Check our web site for suitability of these and other parts, or contact us directly. Original part numbers are fitted for reference only. Check all applications. All parts offered are Majorsell brand and may not be of an original supply. Majorsell kit content and ring sets may be different to the original.

## MAJORSELL REBUILD: 73A008R

## MAJORSELL PARTS FOR: KN13050

Users:	DETROIT							
OE:								



Bore	Drive	Cooling	Weight	Mount	Lube	Water Port	Air inlet	Air delivery
2¾"	Through	Water	25 Kg	Flange	Engine oil	½"	Flange	½"

Repair Kits	Full Kit	Head Kit	Gasket Kit	Valve Kit	Valve Plate	Cooling Plate		
	A73RK001	A73RK001A	A73RK001B	A73RK001C				
Piston	Std	+0.010"	+0.020"	+0.030"	+0.040"			
	020018	020019	020020	020021	020022			
Rings	A73RK002	A73RK003	A73RK004	A73RK005	A73RK006			
Head								
Crankshaft		140185 (Nut)						
Front end Cover								
Rear end Cover								
Conn Rod	220037							
Bolts	140217 (5)	140163	140175 (6)	140160 (4)	140159 (5)			
Other Parts	Bearing	Inserts	Gasket	Gasket				
	6207 (2)	050027 (2)	010059 (Flange)	010035 (Sump)				

## MAJORSELL REBUILD: 73A001R

## MAJORSELL PARTS FOR: KN13220

Users:	CUMMINS							
OE:								



Bore	Drive	Cooling	Weight	Mount	Lube	Water Port	Air inlet	Air delivery
2¾"	Non-through	Water		Flange				

Repair Kits	Full Kit	Head Kit	Gasket Kit	Valve Kit	Valve Plate	Cooling Plate		
	A73RK001	A73RK001A	A73RK001B	A73RK001C				
Piston	Std	+0.010"	+0.020"	+0.030"	+0.040"			
	020018	020019	020020	020021	020022			
Rings	A73RK002	A73RK003	A73RK004	A73RK005	A73RK006			
Head								
Crankshaft								
Front end Cover								
Rear end Cover								
Conn Rod	220037							
Bolts								
Other Parts	Roller Bearing	Front Bush	Inserts	Plunger				
	6011	050137	050027 (2)	210054				



Check our web site for suitability of these and other parts, or contact us directly. Original part numbers are fitted for reference only. Check all applications. All parts offered are Majorsell brand and may not be of an original supply. Majorsell kit content and ring sets may be different to the original.

**MAJORSELL PARTS FOR: KN16020**

**MAJORSELL REBUILD:**



Users:	CAT	FORD	CUMMINS					
OE:								
Bore	Drive	Cooling	Weight	Mount	Lube	Water Port	Air inlet	Air delivery
2¾"	Non-through	Water		Base				

Repair Kits	Full Kit	Head Kit	Gasket Kit	Valve Kit	Valve Plate	Cooling Plate		
	A73RK001	A73RK001A	A73RK001B	A73RK001C				
Piston	Std	+0.010"	+0.020"	+0.030"	+0.040"			
	020018	020019	020020	020021	020022			
Rings	A73RK002	A73RK003	A73RK004	A73RK005	A73RK006			
Head								
Crankshaft								
Front end Cover								
Rear end Cover								
Conn Rod	220037							
Bolts								
Other Parts	Roller Bearing	Front Bush	Inserts	Plunger				
	6011	050137	050027 (2)	210054				



Check our web site for suitability of these and other parts, or contact us directly. Original part numbers are fitted for reference only. Check all applications. All parts offered are Majorsell brand and may not be of an original supply. Majorsell kit content and ring sets may be different to the original.





# A66

## A66RK058

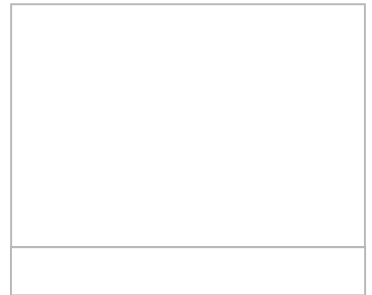
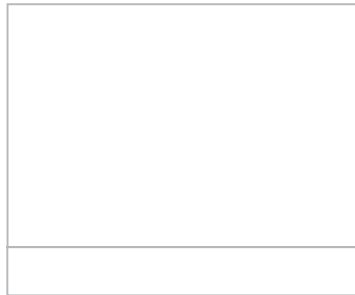
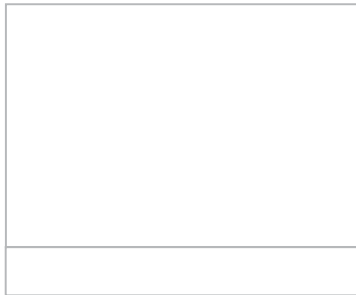
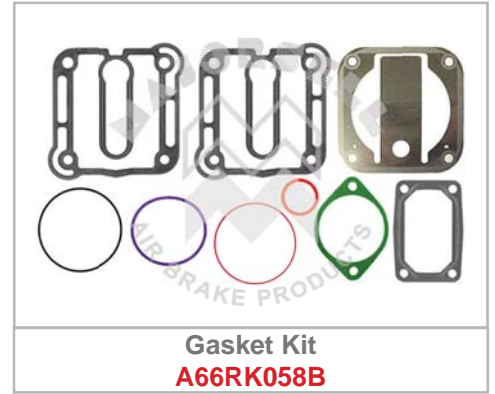

# A68

## A68RK006

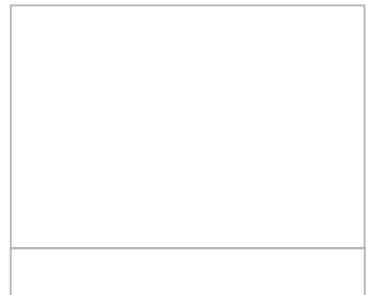
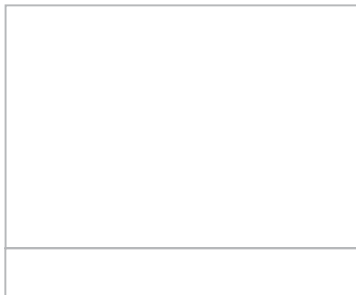
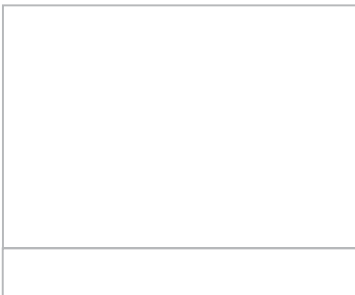
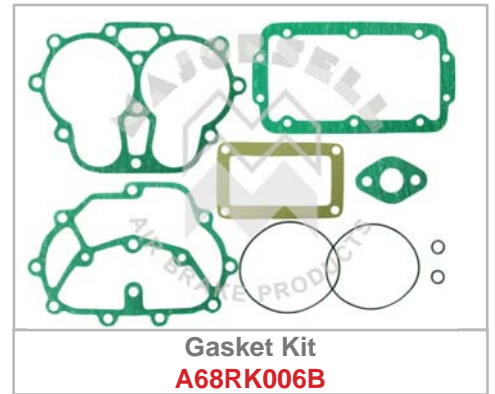
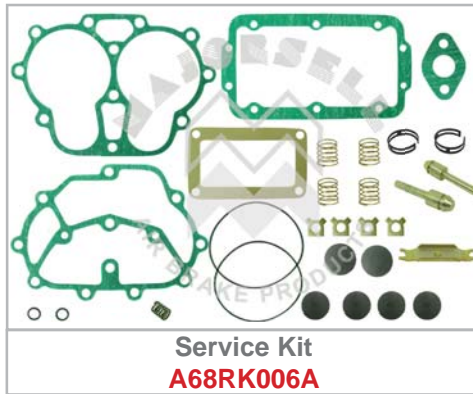
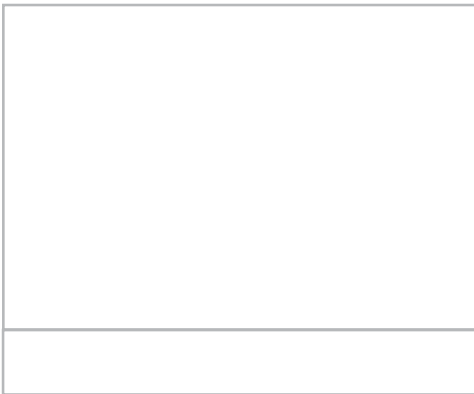

Check our web site for suitability of these and other parts, or contact us directly. Original part numbers are fitted for reference only. Check all applications. All parts offered are Majorsell brand and may not be of an original supply. Majorsell kit content and ring sets may be different to the original.

A68RK007



Full Kit  
**A68RK007**

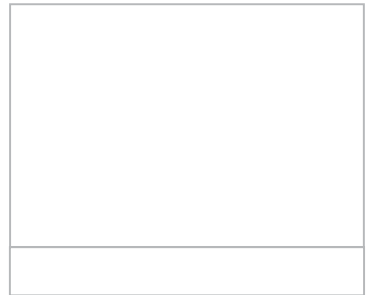
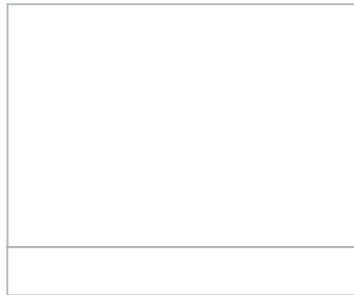
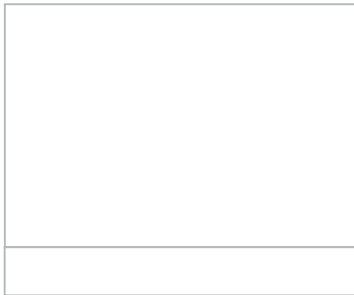
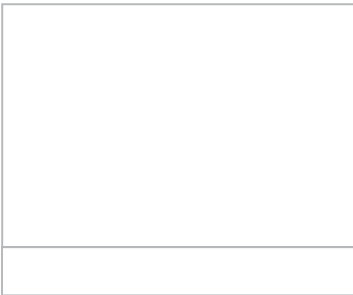
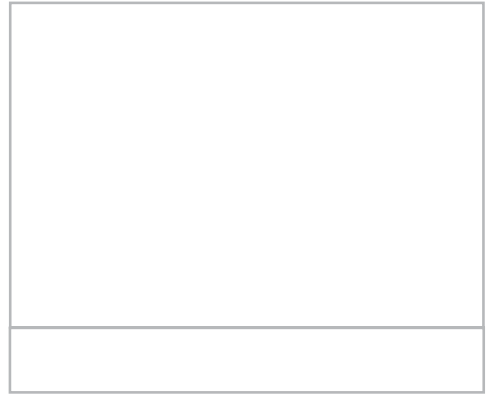
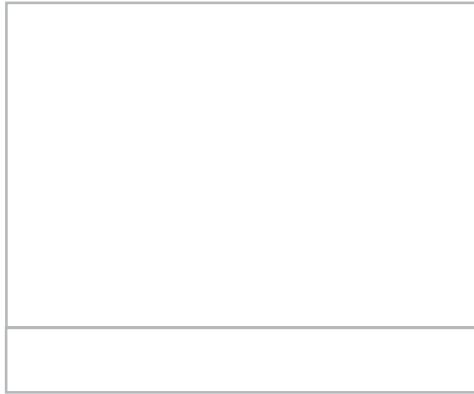

A68RK009



Full Kit  
**A68RK009**

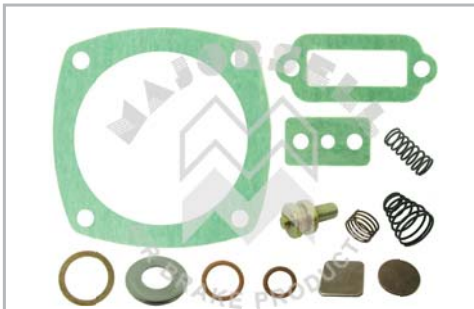

Head Kit  
**A68RK009A**

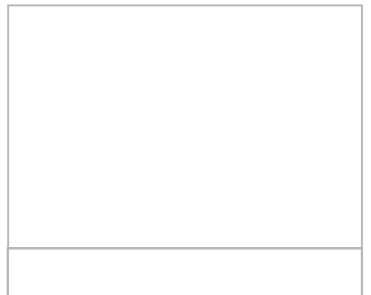
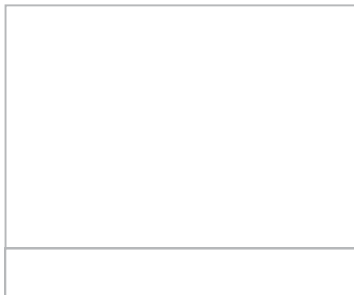
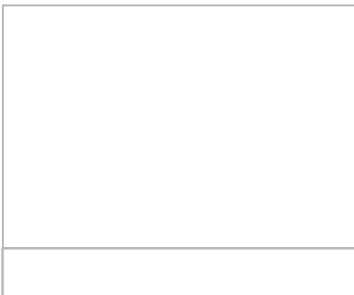
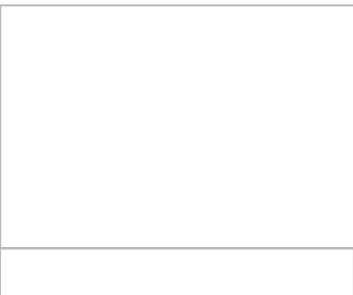
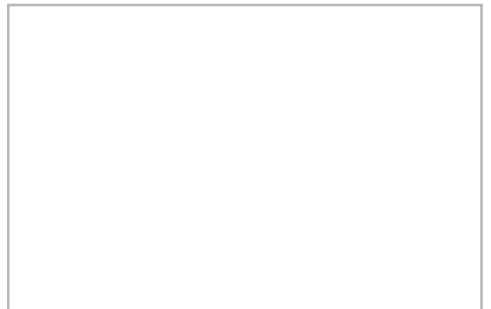

Check our web site for suitability of these and other parts, or contact us directly. Original part numbers are fitted for reference only. Check all applications. All parts offered are Majorsell brand and may not be of an original supply. Majorsell kit content and ring sets may be different to the original.

A68RK038



A68RK040

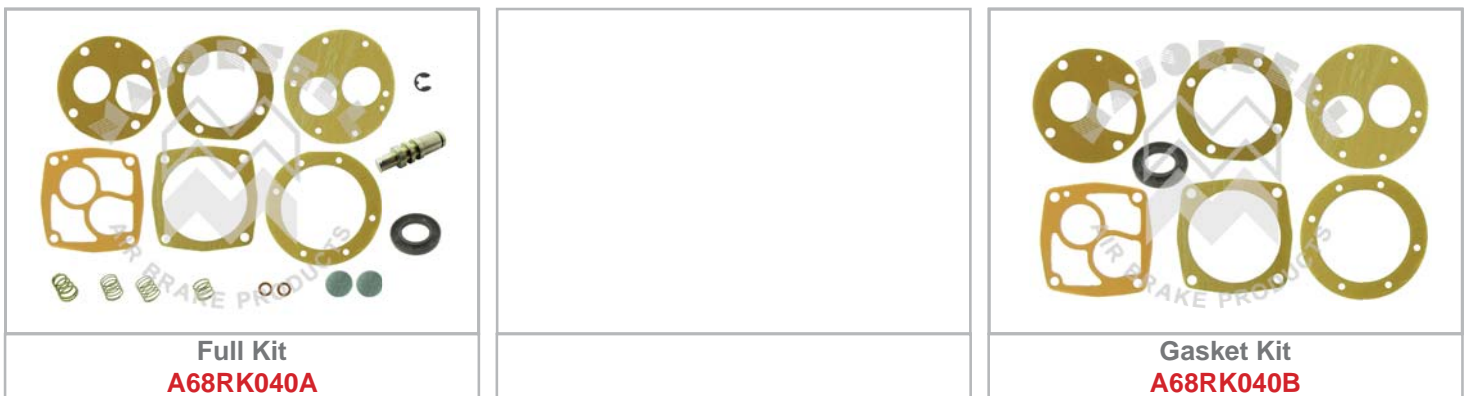

Check our web site for suitability of these and other parts, or contact us directly. Original part numbers are fitted for reference only. Check all applications. All parts offered are Majorsell brand and may not be of an original supply. Majorsell kit content and ring sets may be different to the original.

A68RK056

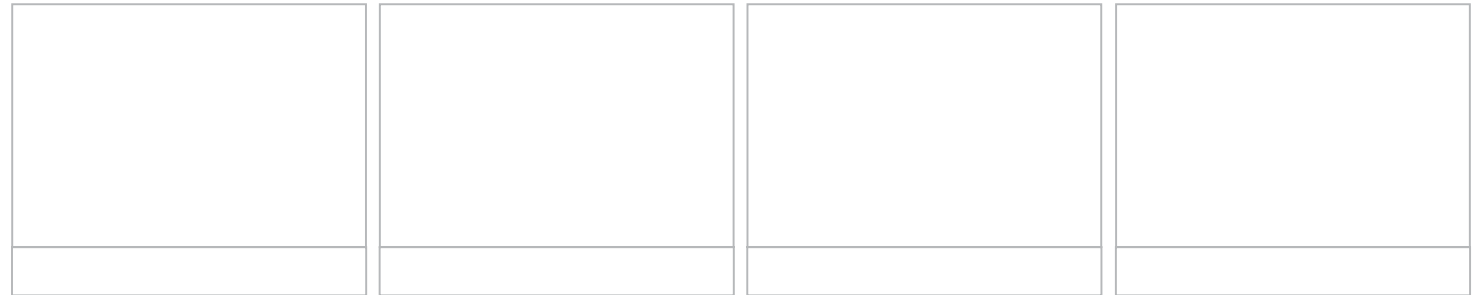

A68RK058



Check our web site for suitability of these and other parts, or contact us directly. Original part numbers are fitted for reference only. Check all applications. All parts offered are Majorsell brand and may not be of an original supply. Majorsell kit content and ring sets may be different to the original.

A68RK092

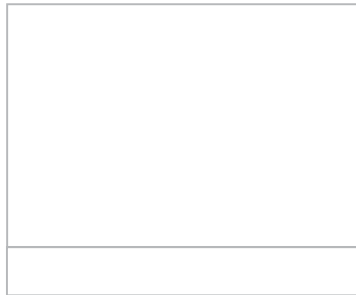
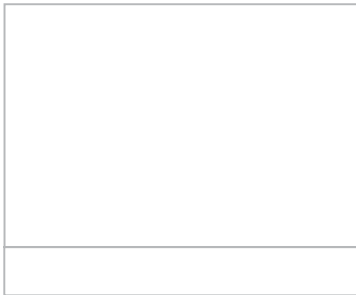
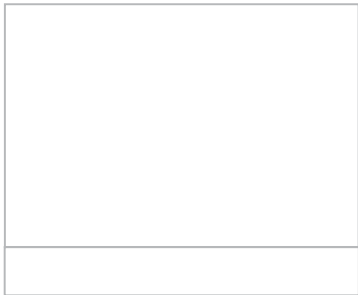
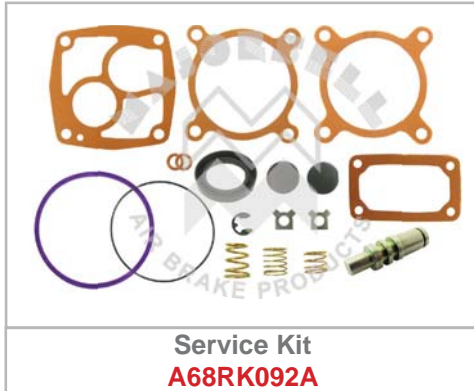
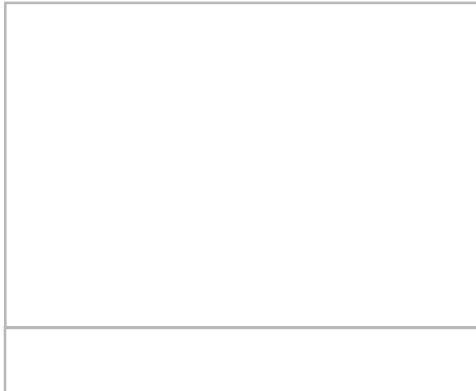

A68RK094

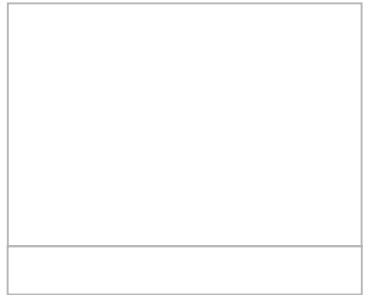
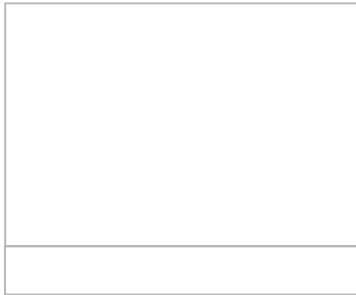
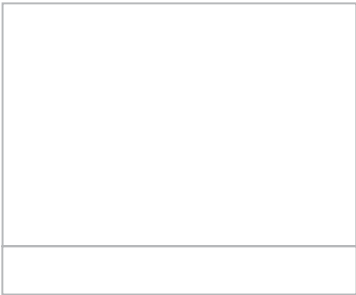
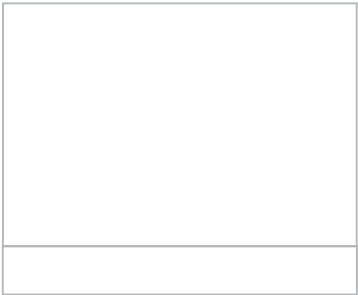
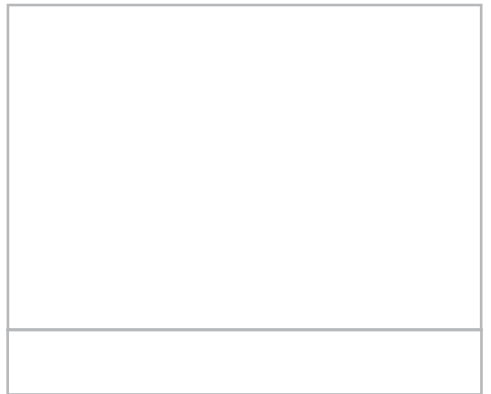
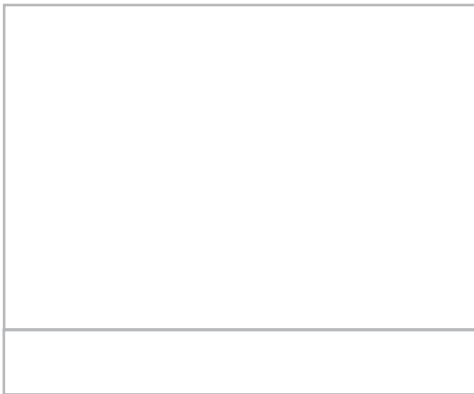

Check our web site for suitability of these and other parts, or contact us directly. Original part numbers are fitted for reference only. Check all applications. All parts offered are Majorsell brand and may not be of an original supply. Majorsell kit content and ring sets may be different to the original.

A68RK096

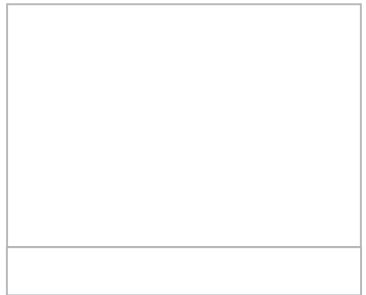
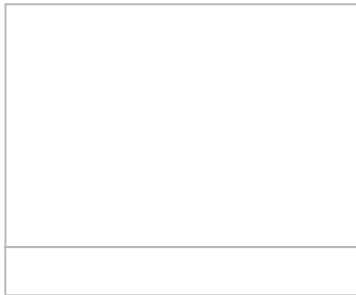
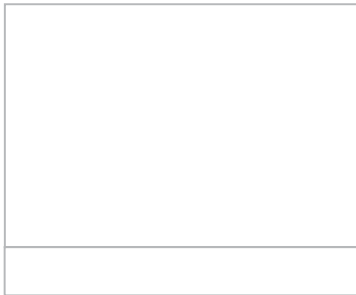
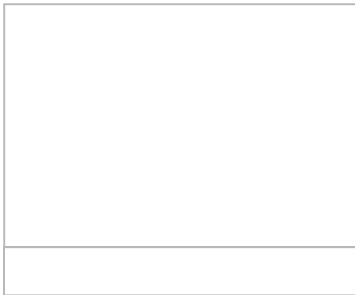
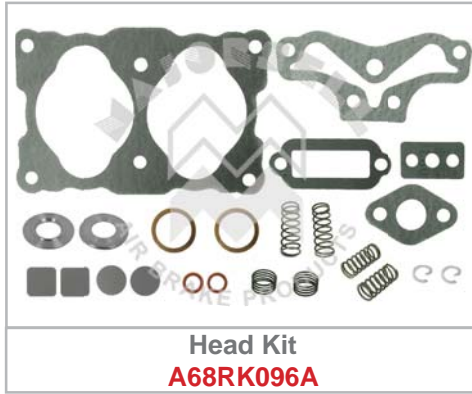

A68RK103

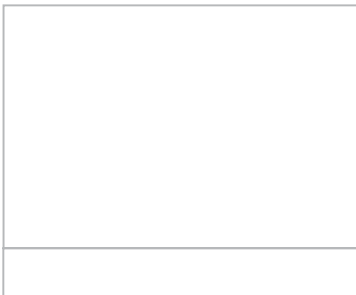
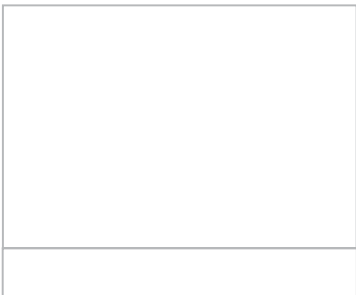
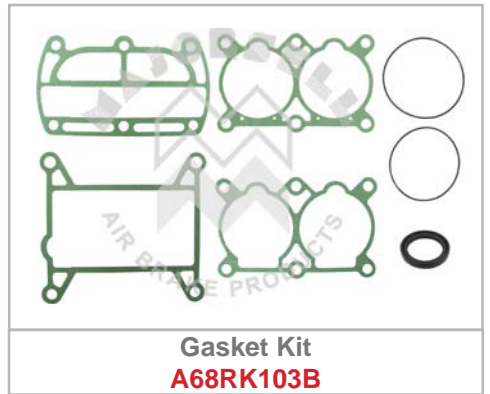
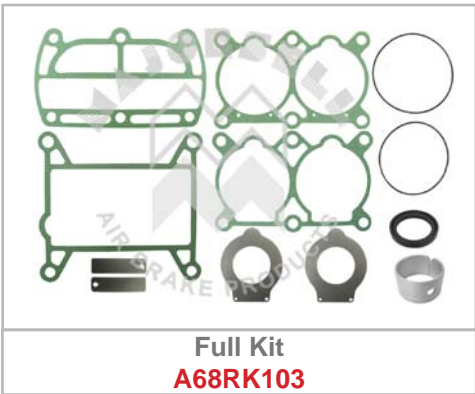

Check our web site for suitability of these and other parts, or contact us directly. Original part numbers are fitted for reference only. Check all applications. All parts offered are Majorsell brand and may not be of an original supply. Majorsell kit content and ring sets may be different to the original.

A68RK104

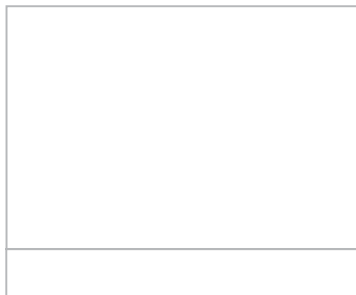
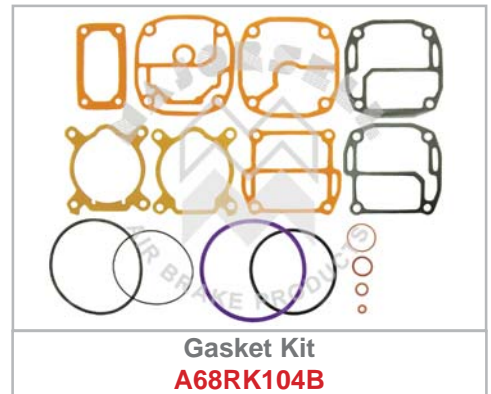
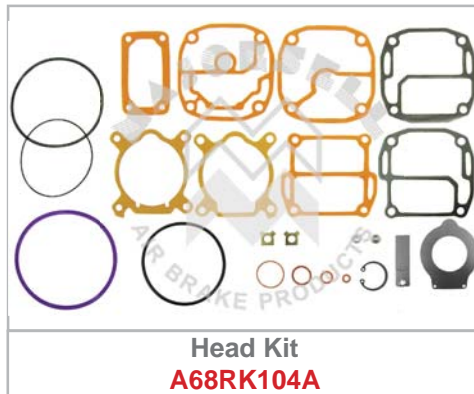
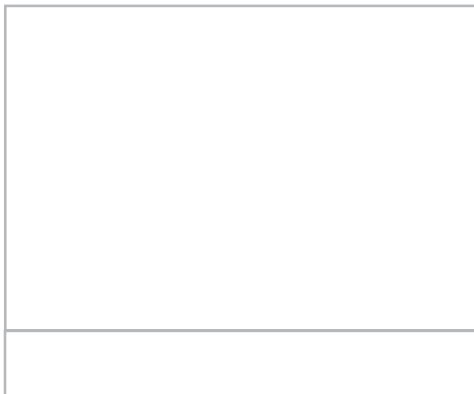

A68RK105

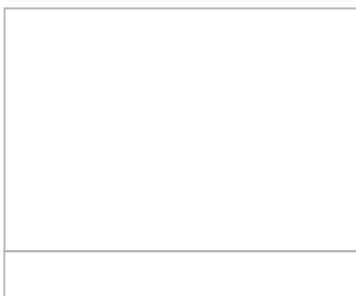

Check our web site for suitability of these and other parts, or contact us directly. Original part numbers are fitted for reference only. Check all applications. All parts offered are Majorsell brand and may not be of an original supply. Majorsell kit content and ring sets may be different to the original.



**A68RK109**

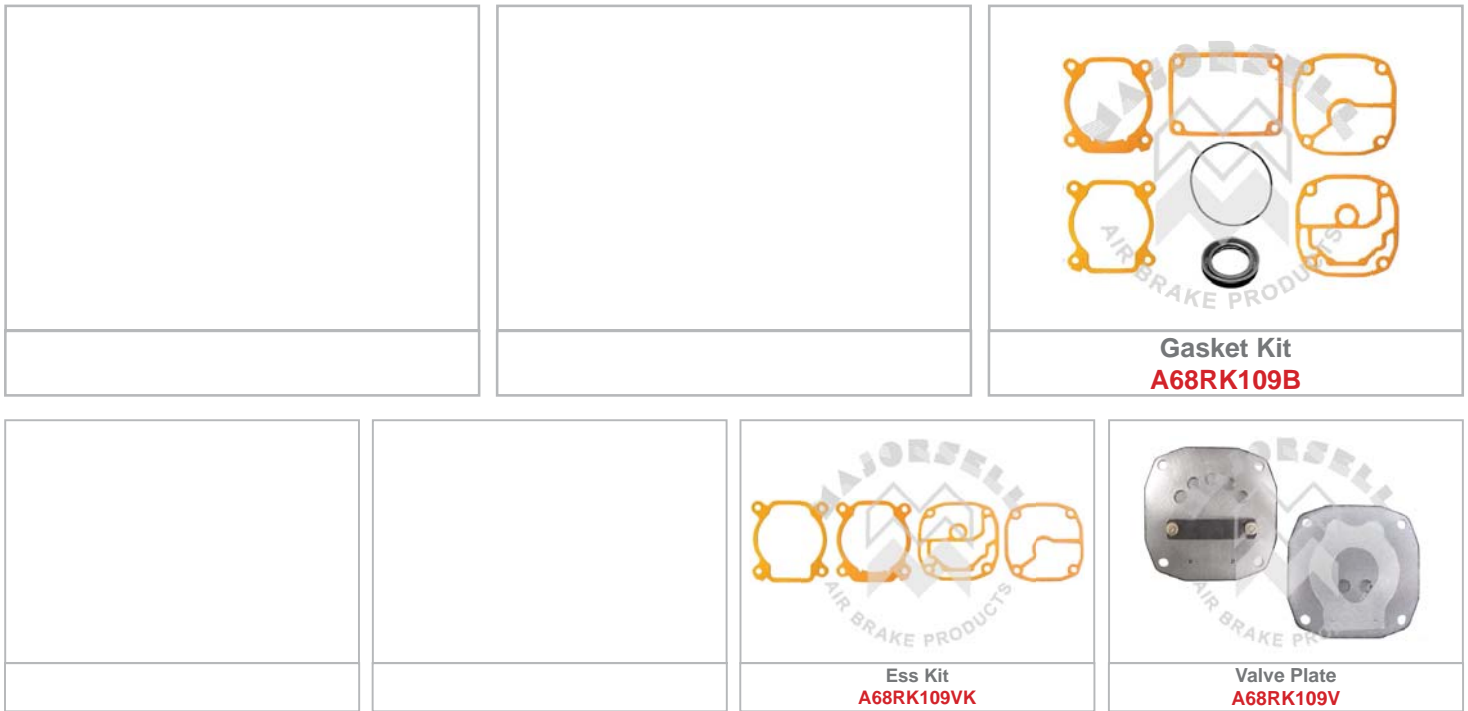

**A68RK115**

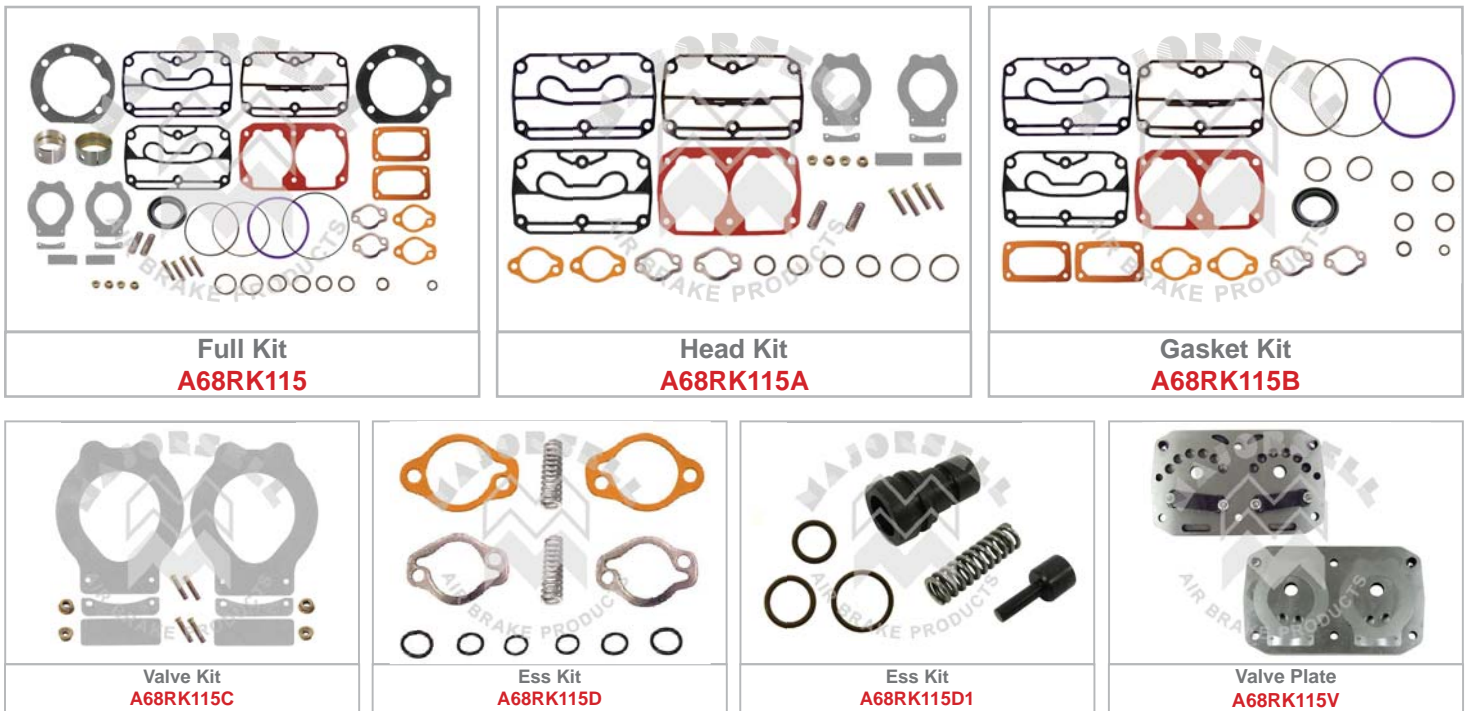

Check our web site for suitability of these and other parts, or contact us directly. Original part numbers are fitted for reference only. Check all applications. All parts offered are Majorsell brand and may not be of an original supply. Majorsell kit content and ring sets may be different to the original.

**A68RK117**

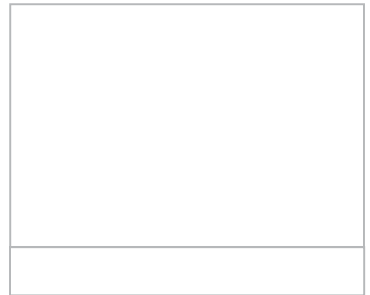
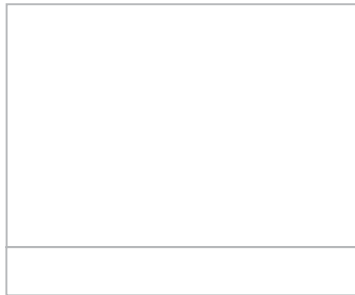
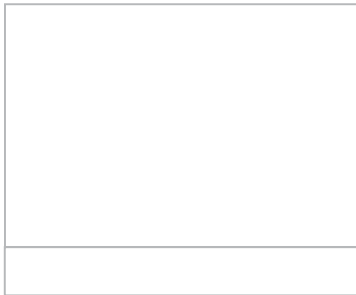

**A68RK118**

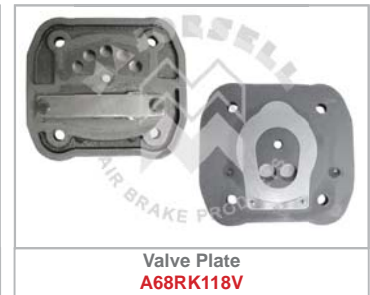
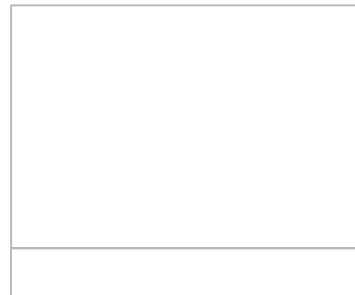
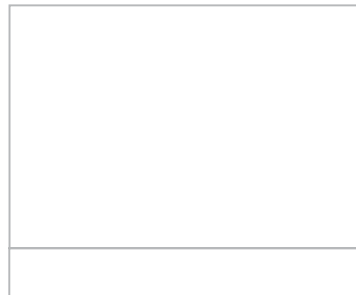
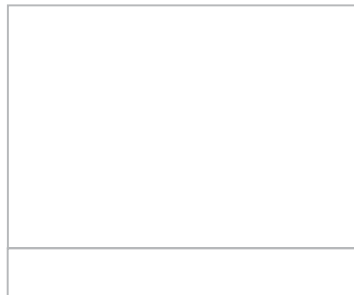
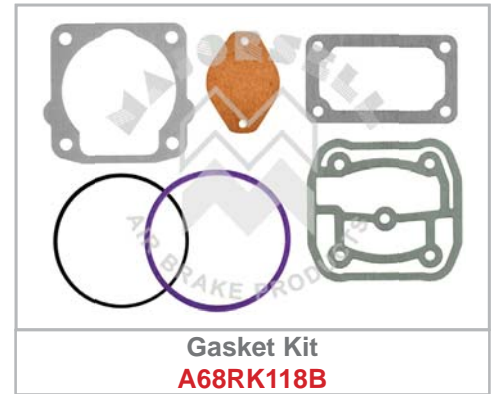

Check our web site for suitability of these and other parts, or contact us directly. Original part numbers are fitted for reference only. Check all applications. All parts offered are Majorsell brand and may not be of an original supply. Majorsell kit content and ring sets may be different to the original.

A68RK124

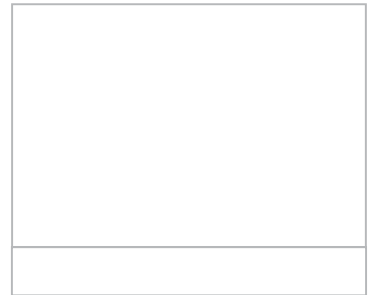
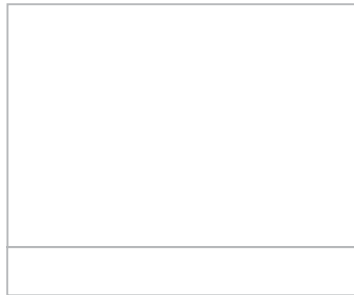
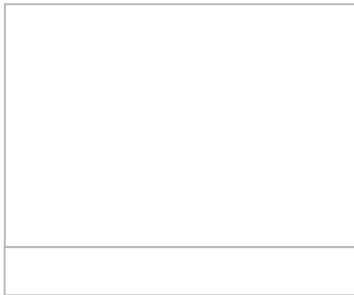
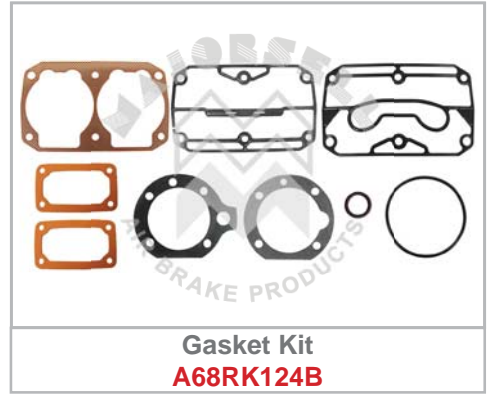

A69RK021

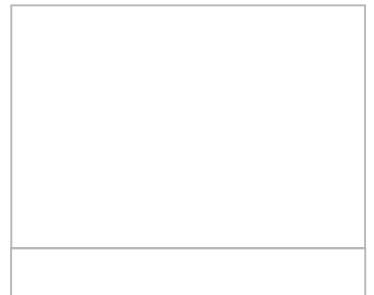
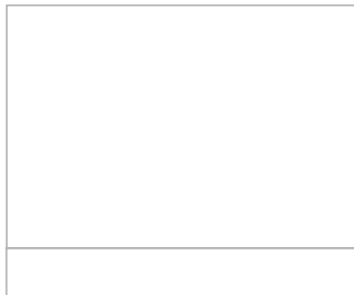
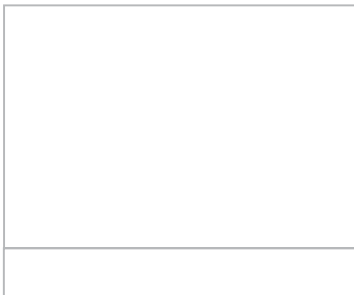
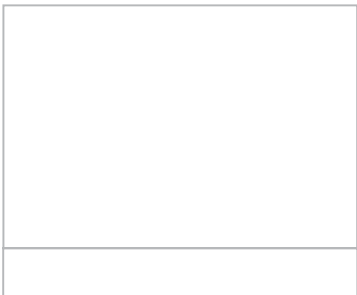

Check our web site for suitability of these and other parts, or contact us directly. Original part numbers are fitted for reference only. Check all applications. All parts offered are Majorsell brand and may not be of an original supply. Majorsell kit content and ring sets may be different to the original.

# A73

## A73RK001

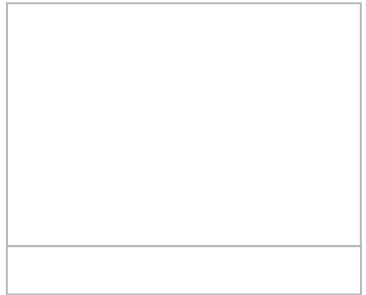
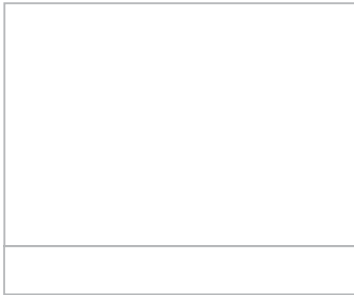
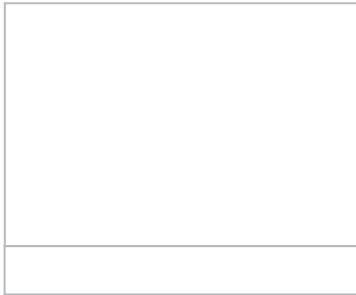
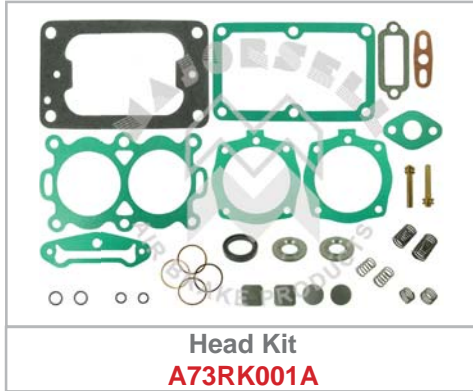

## A73RK014



## A73RK015

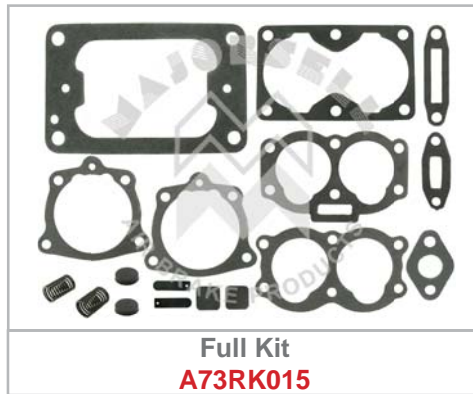

Check our web site for suitability of these and other parts, or contact us directly. Original part numbers are fitted for reference only. Check all applications. All parts offered are Majorsell brand and may not be of an original supply. Majorsell kit content and ring sets may be different to the original.

A74RK001



Unloader Kit  
A74RK001A

A74RK002



Full Kit  
A74RK002A

A74RK010



Gasket Kit  
A74RK010

A74RK012



SUITABLE FOR ST676 TYPE

Service Kit  
A74RK012



Check our web site for suitability of these and other parts, or contact us directly. Original part numbers are fitted for reference only. Check all applications. All parts offered are Majorsell brand and may not be of an original supply. Majorsell kit content and ring sets may be different to the original.

A74RK016

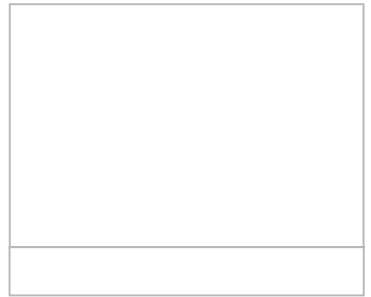
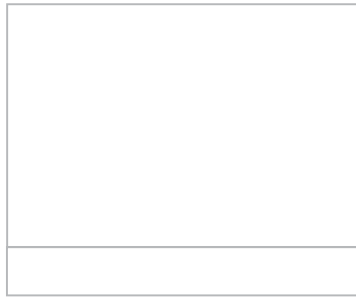
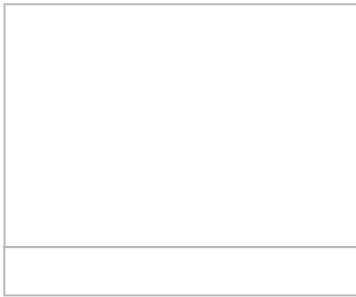
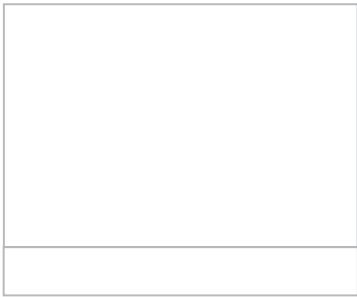
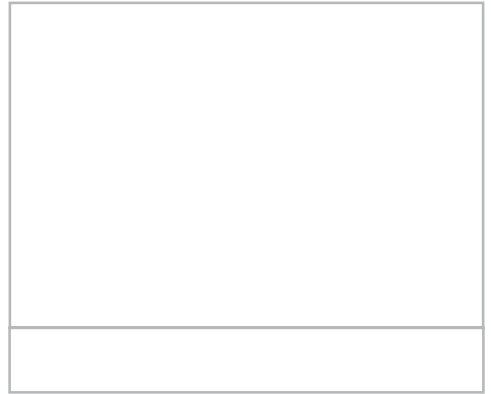
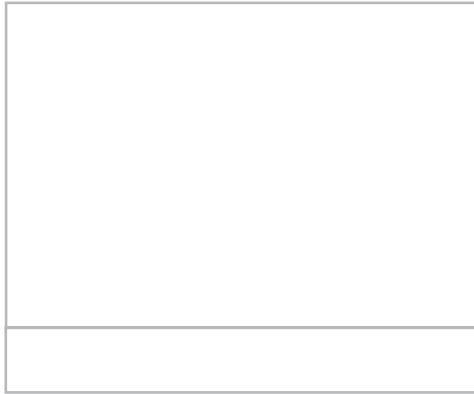

A74RK017



Check our web site for suitability of these and other parts, or contact us directly. Original part numbers are fitted for reference only. Check all applications. All parts offered are Majorsell brand and may not be of an original supply. Majorsell kit content and ring sets may be different to the original.

**B68RK003**



**D2 Gov Kit**  
**B68RK003**

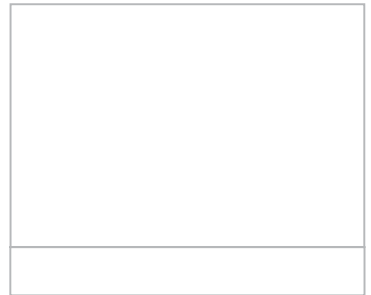
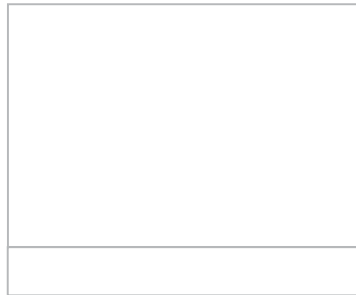
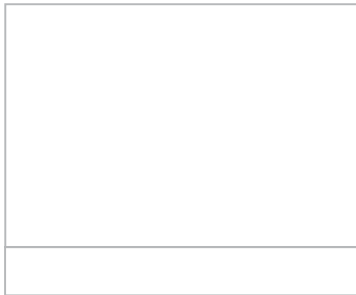
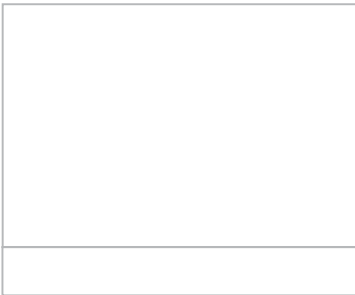
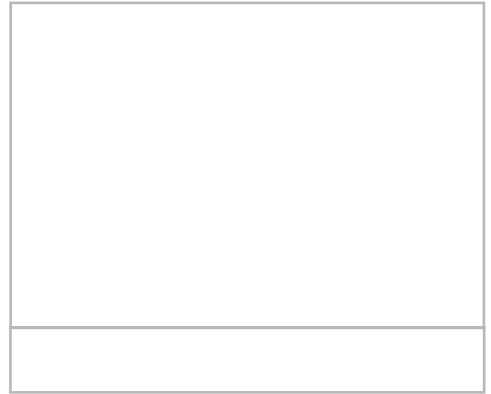
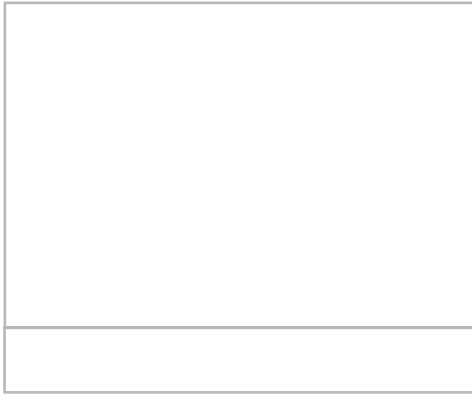

**220007**



**Valve Plate**  
**220007**

**220020**



**Valve Plate**  
**220020**



Check our web site for suitability of these and other parts, or contact us directly. Original part numbers are fitted for reference only. Check all applications. All parts offered are Majorsell brand and may not be of an original supply. Majorsell kit content and ring sets may be different to the original.



Tel: +44(0)121 544 0951  
e-mail: [sales@majorsell.co.uk](mailto:sales@majorsell.co.uk)  
[www.majorsell.co.uk](http://www.majorsell.co.uk)



Majorsell Limited  
Unit 2 Credenda Road  
West Bromwich  
B70 7JE  
England