

IONICMAT

NEGATIVE ION CAR MAT

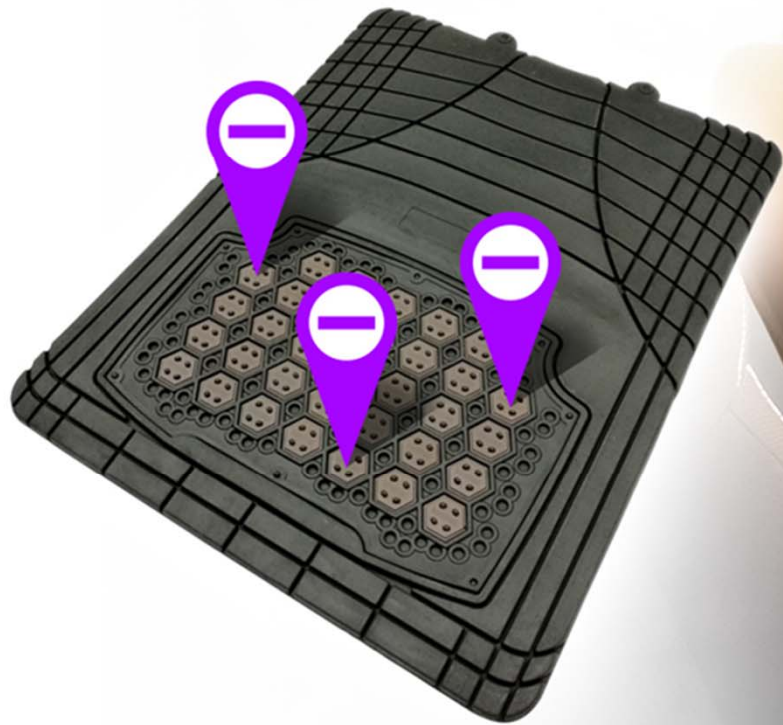

A QUALITY PRODUCT BY



IONICMAT
NEGATIVE ION CAR MAT

A QUALITY PRODUCT BY



DID YOU KNOW?

Vehicle passengers are also exposed to polluted and contaminated air similar to pedestrians and riders.

(Source: King's College London)

Contaminated air in the vehicle cabin can cause drivers to experience drowsiness while driving which lead to accidents.

(Source: Michael Pines)



IONICMAT
NEGATIVE ION CAR MAT

A QUALITY PRODUCT BY



POOR AIR QUALITY IN VEHICLE CABIN

Vehicles with small cabin space, poor ventilation can cause cross contamination between passengers.

New vehicle cabin releases odour which is actually harmful to passengers. The 4 main causes are...



POOR AIR QUALITY IN VEHICLE CABIN

- Paint, glue and adhesives used inside the vehicle's cabin parts contain formaldehyde, acetone, xylene, benzene and others toxic chemicals.
- The air conditioning in the vehicle cabin could emit harmful gases which deteriorates the air quality if the air filter in the air conditioning system is not properly maintained.
- Carbon monoxide emitted from the vehicle engine, gasoline fumes and other exhaust gases which enters the vehicle cabin.
- Cigarette smoke, body odour from human activities could also contaminate the air in the vehicle cabin.



WHAT IS A NEGATIVE ION?

An ion is an atom or molecule with electrical charge which is found in the air. It is known as “air ions” and it contains positive ion and negative ion.

Positively charged ions (cation) are BAD for us while negatively charged ions (anion) are GOOD for us.

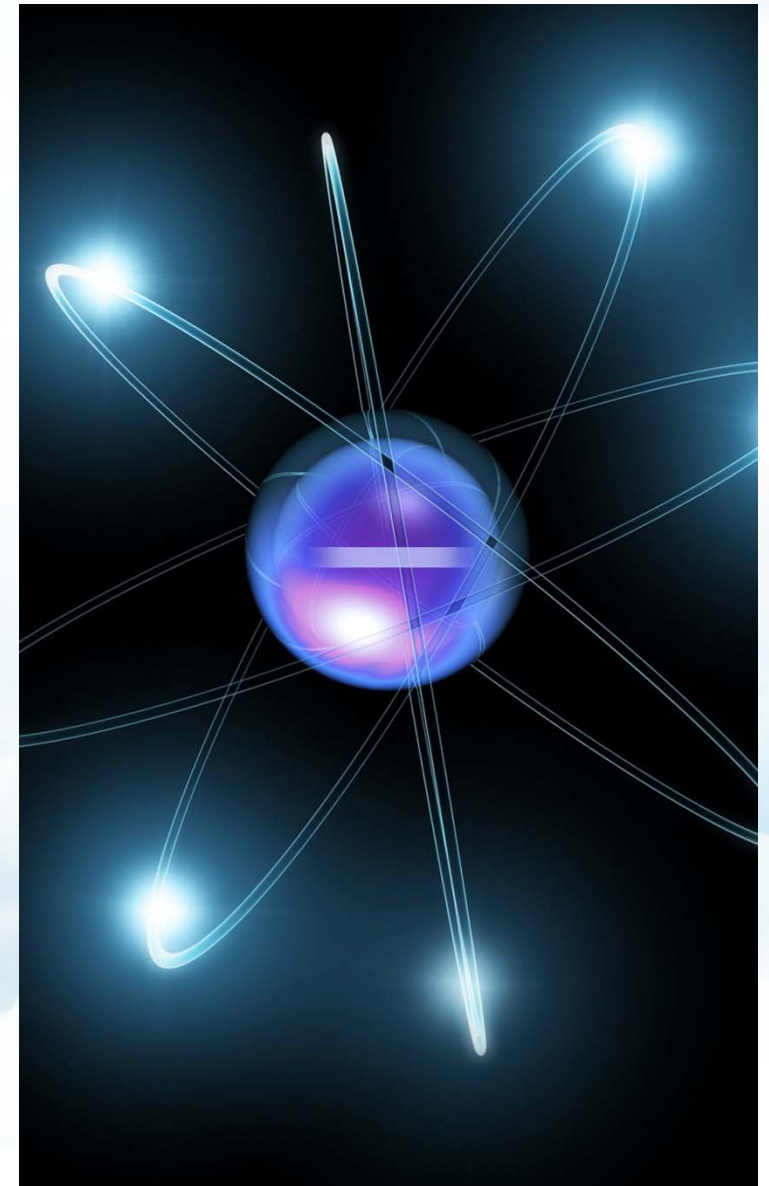

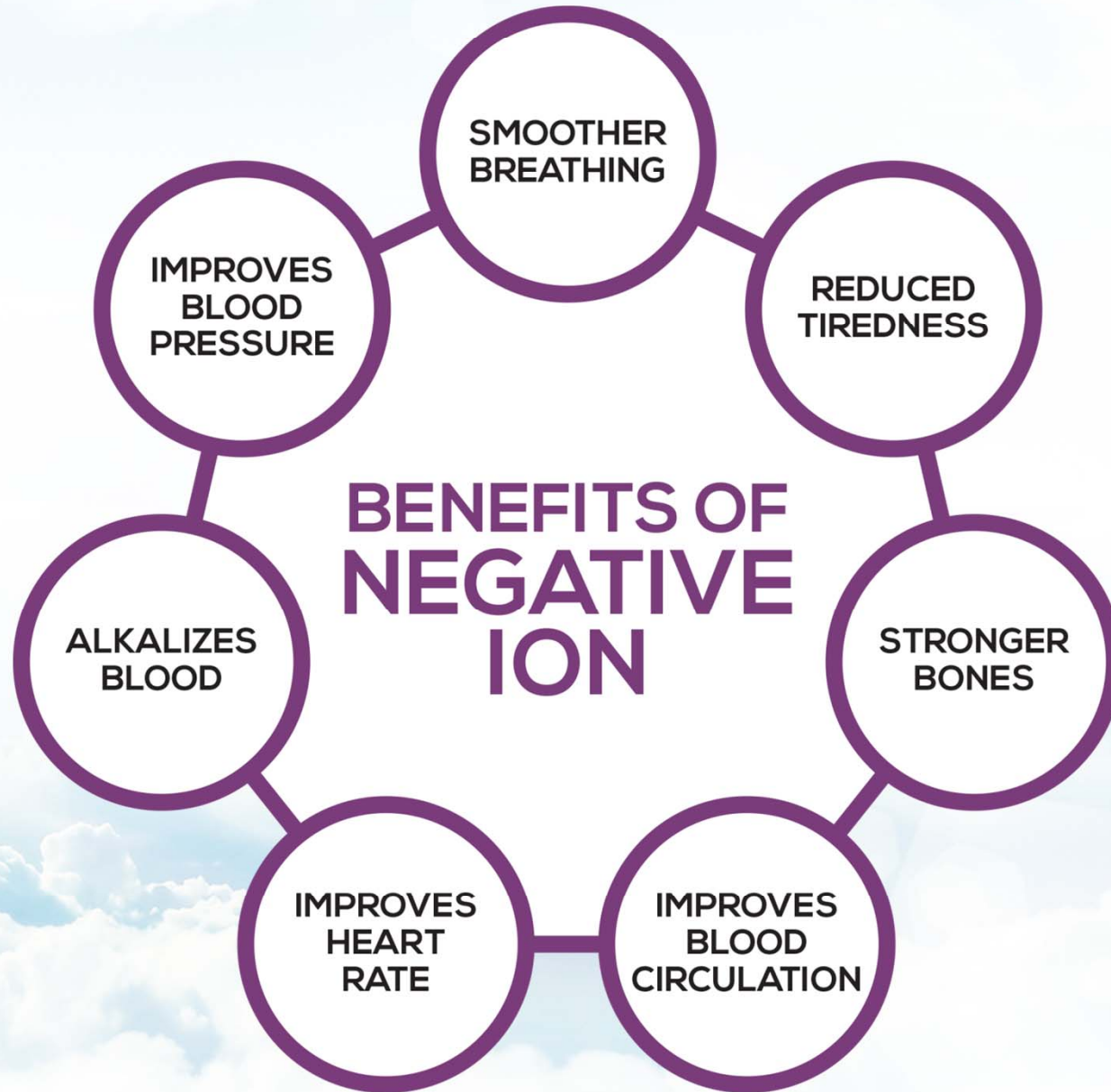

CONCENTRATION OF NEGATIVE IONS IN VARIOUS ENVIRONMENTS

ENVIRONMENT	CONCENTRATION OF NEGATIVE ION IN THE AIR (PER CM ³)	STATE OF HEALTH
Factory with workers	0 - 50	May cause a variety of diseases
Indoor city area	60 - 50	Easily induces psysiological disorders
Street with surrounding green trees	200 - 500	On the edge of physiological disorders
Urban park areas	500 - 1000	Maintains basic needs for human health
Outdoors / Open field	1000	Strengthens the immune system of human body
High mountain areas	2000 - 3000	Kills bacteria and reduces the spread of diseases
Forests	2000 - 3000	Facilitates natural healing
Waterfalls	5000	Has natural healing properties

IONICMAT
NEGATIVE ION CAR MAT

A QUALITY PRODUCT BY



VEHICLE CABIN WITH **POSITIVE** IONS



IONICMAT
NEGATIVE ION CAR MAT

A QUALITY PRODUCT BY
MALCORP[®]
THE NAME THE WORLD TRUSTS

VEHICLE CABIN WITH **NEGATIVE IONS**



IONICMAT
NEGATIVE ION CAR MAT

A QUALITY PRODUCT BY
MALCORP[®]
THE NAME THE WORLD TRUSTS

INTRODUCING THE IONICMAT

THE NEGATIVE ION MAT FOR YOUR VEHICLE

COLOUR : BLACK

Front x 2 Pcs
530 x 680 x 11.50 mm
(with Tourmaline)

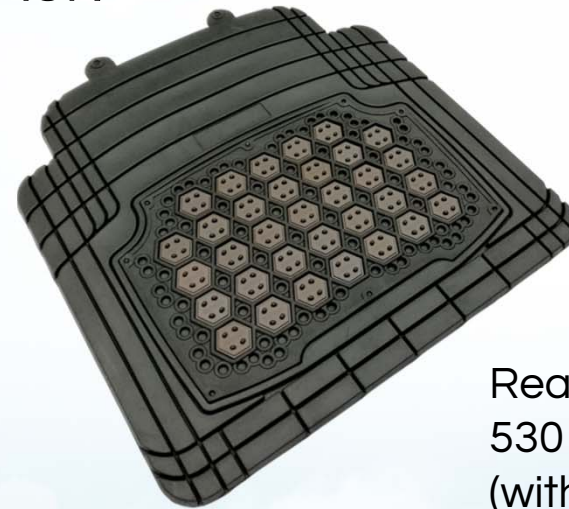

Rear x 2 Pcs
530 x 530 x 11.50 mm
(with Tourmaline)

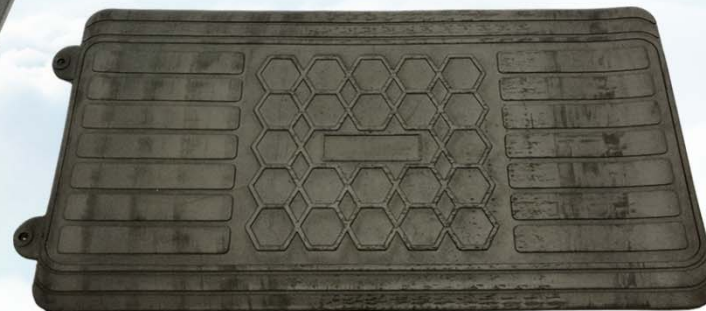

Bridge x 1 Pc
320 x 620 x 3.0 mm

IONICMAT
NEGATIVE ION CAR MAT

A QUALITY PRODUCT BY
MALCORP[®]
THE NAME THE WORLD TRUSTS

INTRODUCING THE IONICMAT THE NEGATIVE ION MAT FOR YOUR VEHICLE

COLOUR : GREY

Front x 2 Pcs
530 x 680 x 11.50 mm
(with Tourmaline)

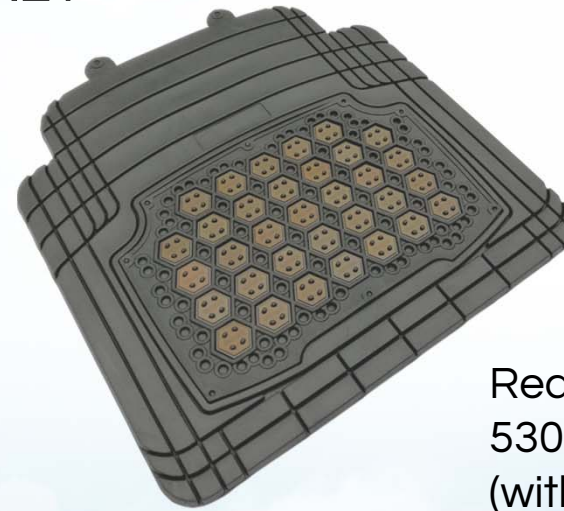
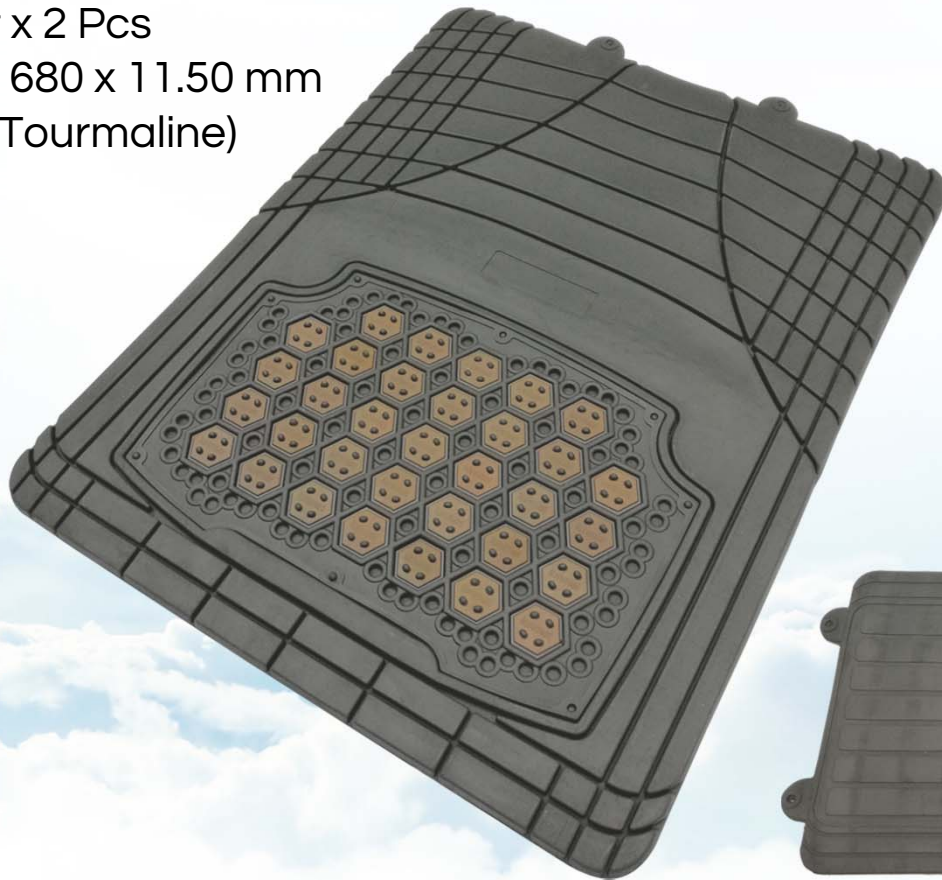

Rear x 2 Pcs
530 x 530 x 11.50 mm
(with Tourmaline)

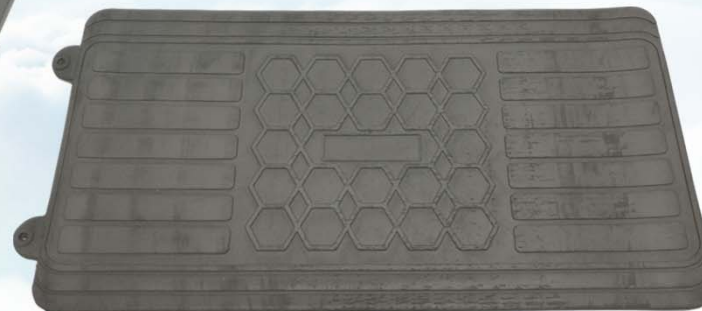

Bridge x 1 Pc
320 x 620 x 3.0 mm

IONICMAT
NEGATIVE ION CAR MAT

A QUALITY PRODUCT BY



WHAT IS THE IONICMAT?

IONICMAT is designed to eliminate air pollution in a vehicle cabin.

The IONICMAT fills the interior of your vehicle with health-inducing negative ions, giving your family and you healthier and refreshing air when driving.

The IONICMAT recreates the health-giving benefits of Mother Nature with modern technology by infusing the car mat with TOURMALINE to produce an endless supply of negative ions. The mat releases surface negative ions more than $1,200/\text{cm}^3$, effectively filling your car cabin with a sea of negative ions.

IONICMAT effectively neutralizes positively-charged ion (cations), removes odour, purifies the air and inhibits bacterial growth. Driver and passengers will feel refreshed and energized, as you would feel on a trip to the mountain, forest or seaside.

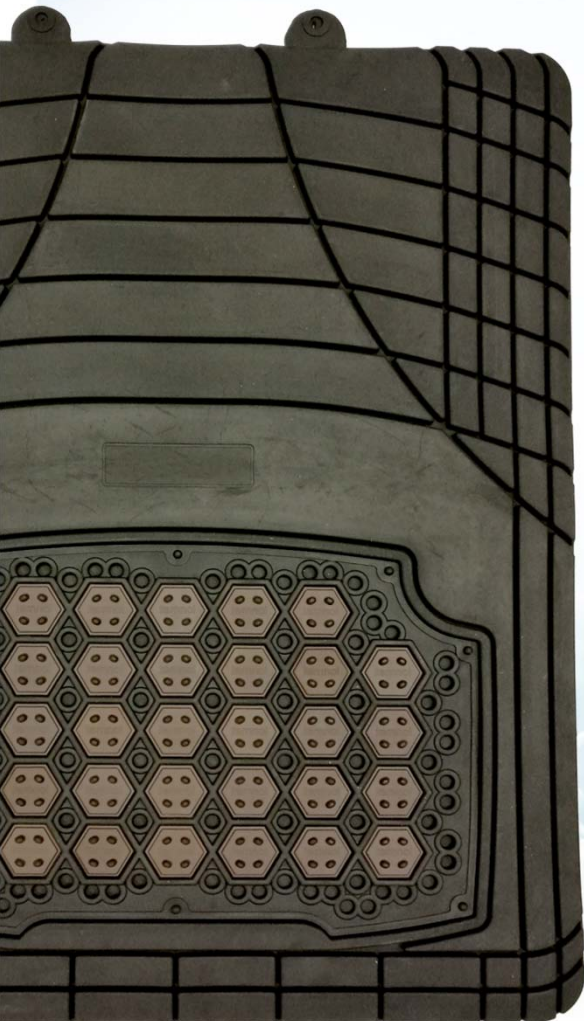

WHAT ARE TOURMALINES?

Tourmaline is a natural mineral widely used as a semi-precious gemstone, and comes in many different shapes and colours. Tourmaline is unique and has a high natural output of negative ions.

Tourmaline has a positive charge at one end and a negative charge at the other end which is also known as pyro-electric charge. Tourmaline can also be charged when pressure is applied.

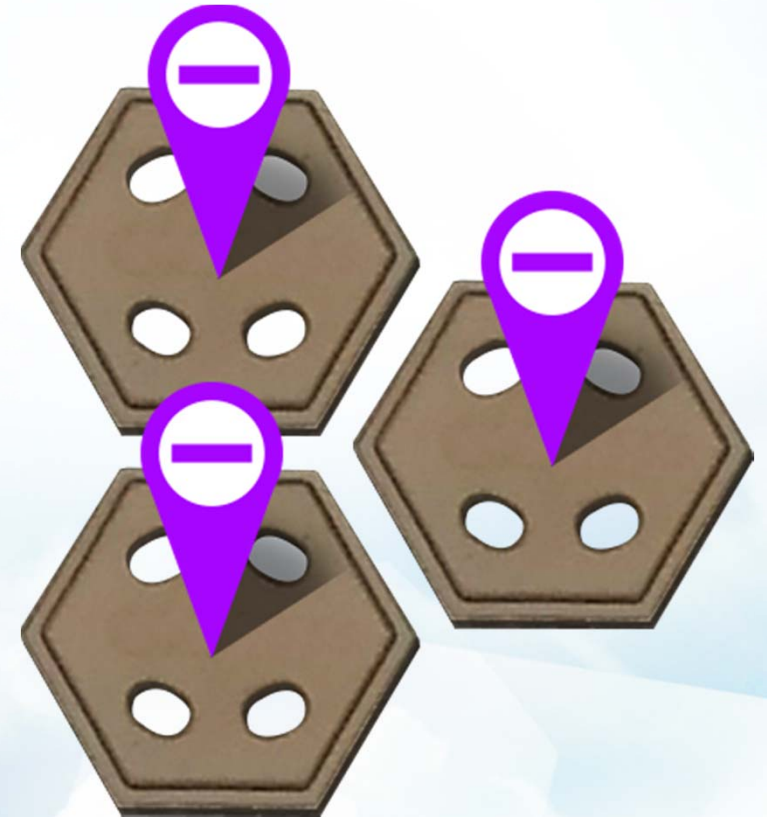

WHY USE IONICMAT?

6 MAIN BENEFITS OF THE IONICMAT

AIR
PURIFICATION



DETOXIFYING



ANTIOXIDANT



DUST
CONTROL



ANTI
BACTERIAL



ANTI
TVOC





AIR PURIFICATION

IONICMAT emits approximately 1200/cm³ of negative ions perpetually to purify the air in vehicle cabin keeping it well ventilated and reducing the effect of positive ions. Meanwhile, negative ions can break down and neutralize harmful pollutants (formaldehyde, benzene), and remove odor effectively.



DUST CONTROL

Negative ions also help to eliminate pollutants in the air by attracting dust particles to the mat, giving the cabin refreshed air.



DETOXIFYING

Negative ions improve the oxygen in the vehicle cabin providing drivers and passengers healthier breathing air. Clean air helps detoxify the human body improving the driver's mental alertness for a much safer drive.



ANTIBACTERIAL

Negative ions have antibacterial properties which help to improve the hygiene of the vehicle cabin. It will increase the immunity of drivers and passengers and reduce the risk of any bacterial infections.



ANTIOXIDANT

The human body naturally produces free radicals in the blood stream. Negative ions work as antioxidants to neutralize the free radicals and counteract their damaging effects.



ANTI TVOC

Negative ions can eliminate TVOC (Total Volatile Organic Compounds) effectively, keeping the air fresh and better ventilation inside the vehicle cabin.

WHY CHOOSE IONICMAT? 6 MAIN FEATURES OF IONICMAT

ECO
FRIENDLY



EASY
INSTALLATION



ANTI-SKID



EASY
CLEANING



WATER
PROOF



COMFORTABLE
& BEAUTIFUL





ECO-FRIENDLY

Substantial amount of negative ions will improve the air quality and freshness and provide a more cooling effect in the vehicle cabin.



EASY CLEANING

The IONICMAT is designed with a double-groove recessed structure which helps accumulated dust and dirt. It is very easy to clean by removing just the upper mesh layer.



EASY INSTALLATION

The IONICMAT is completely customizable to fit all sedan car models.

IONICMAT
NEGATIVE ION CAR MAT

A QUALITY PRODUCT BY
 **MALCORP**[®]
THE NAME THE WORLD TRUSTS



WATER PROOF AND ANTI-SKID

IONICMAT is made with water resistant materials to prevent from getting wet and slippery compared to a standard car mat. It is designed with anti-skid structure to help prevent shifts.



COMFORTABLE & BEAUTIFUL

The IONICMAT's design is elegant and yet it provides comfort to drivers while driving.



IONICMAT PRODUCT SPECIFICATIONS – SEDAN VEHICLES

Material	: Natural Rubber
Quantity Per Set	: 5 Pcs
Product Measurement	: Front - 530 x 680 x 11.50 mm (with Tourmaline) : Rear - 530 x 530 x 11.50 mm (with Tourmaline) : Bridge - 320 x 620 x 3.0 mm
Tourmaline Quantity	: 33pcs / mat 132 pcs / set
Mat Color	: Black / Grey
Tourmaline Color	: Brown

IONICMAT

NEGATIVE ION CAR MAT

A QUALITY PRODUCT BY



IONICMAT PACKAGING

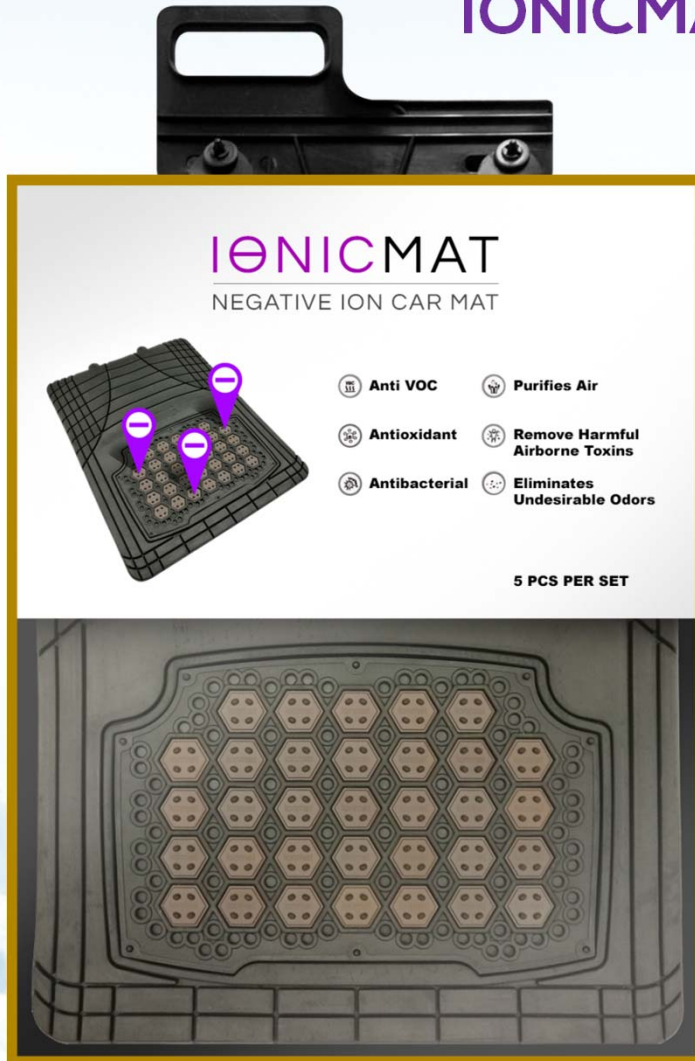

FRONT

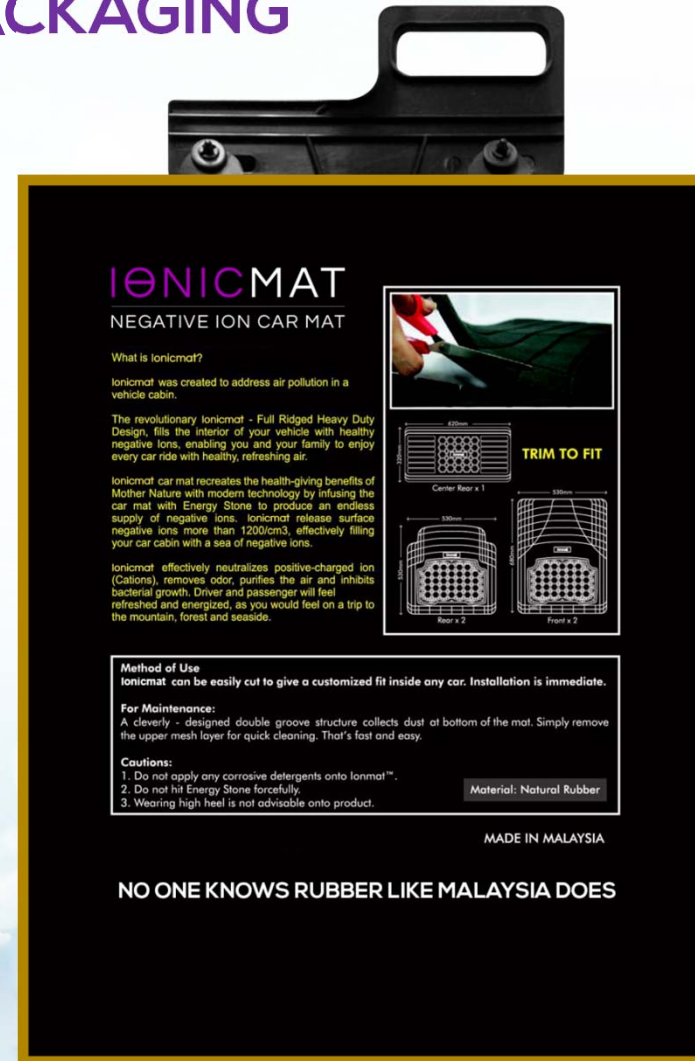

BACK

IONICMAT PACKAGING INFORMATION – SEDAN VEHICLES

5 pcs per set (Non-woven fabric bag packaging with hanger), 3 sets per carton

Gross Weight : 9.50 kg/set 28.50 kg/carton

Nett Weight : 9.00 kg/set 27.00 kg/carton

Shipping Information (Estimated)

20 feet container : 936 sets / 312 cartons (Weight (9.0 ton))