

Art.	Portata Capacité Nutzlast Capacity	A	B	C	D	E	F	Alzata Hauteur maxi Hubhöhe max. Maximum lift	Diametro est. max. Diam. externe maxi Externer Durch. max Outside diam. max
	kg	mm	mm	mm	mm	mm	mm	mm	mm
N90	90	1900	740	90	320	730	360	930	820
N100	100	1200	740	80	320	620	380	930	820
N700	700	1200	940	120	500	1030	420 - 670	650	1125

N700

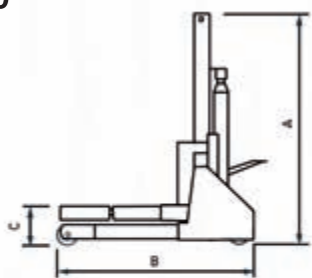

idraulico

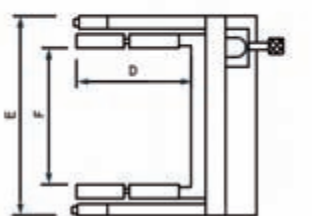

N100

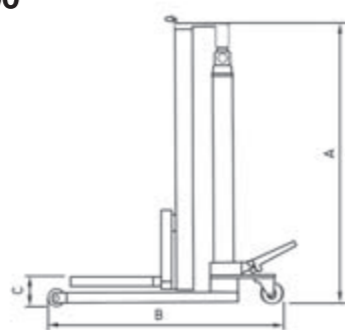

idraulico

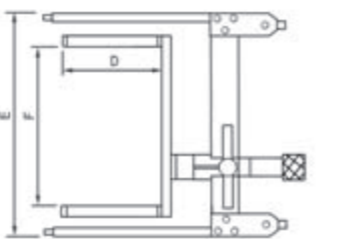

N90

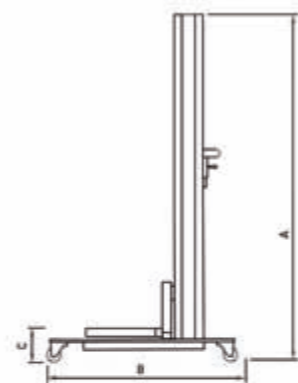

pneumatico

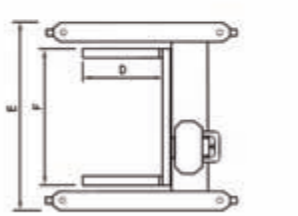

Cimm di Mazzola e Co. SNC - via Isole Corso, 2/C
36054 Montebello Vic. Italia - tel. e Fax +39 0444/649807
www.mazzola-garageequipment.com
e-mail: mazzola@inwind.it



Made in Italy

www.stargraphic.it



SOLLEVATORI PER PNEUMATICI
TYRE LIFT
APPAREIL DE LEVAGE POUR PNEUS
REINFENHEBER

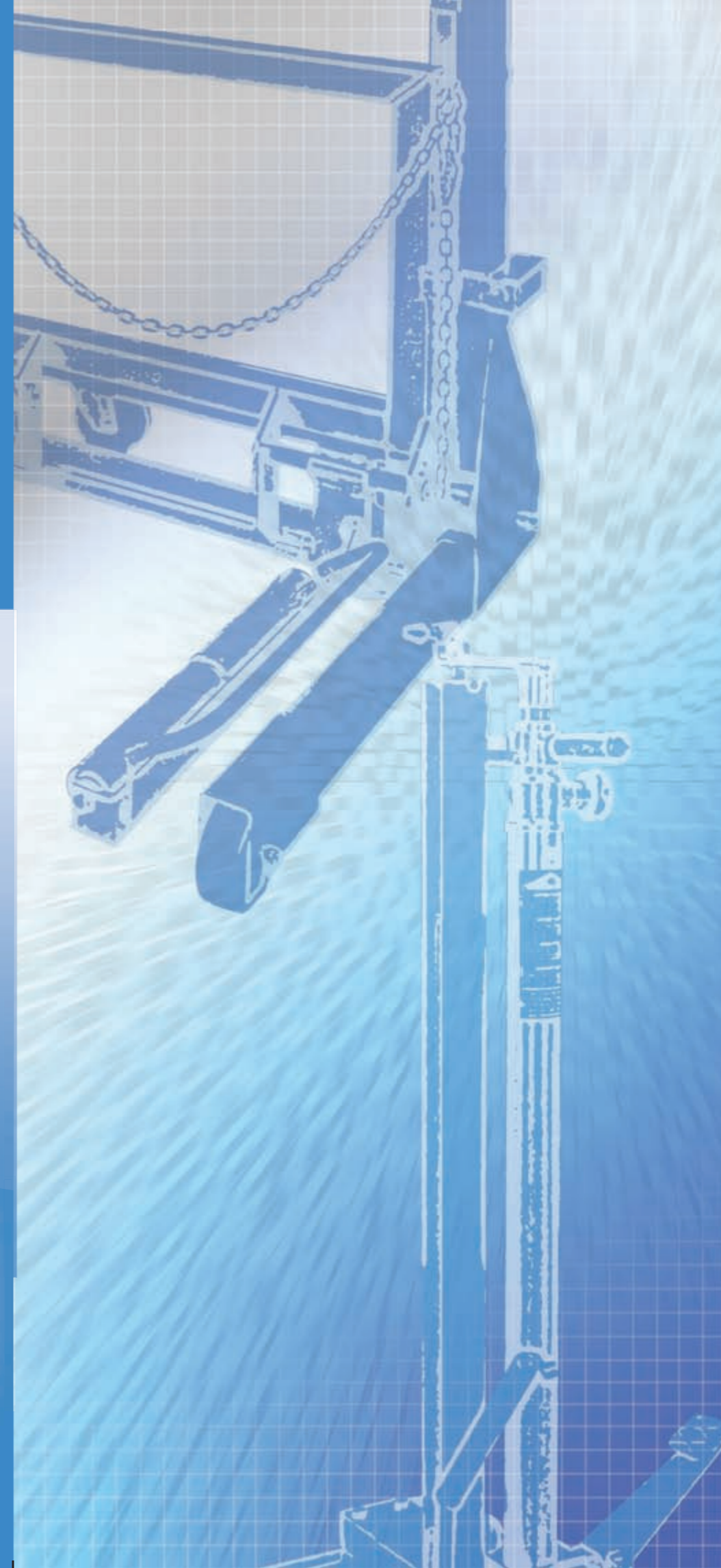



SOLLEVATORI PER PNEUMATICI
TYRE LIFT
APPAREIL DE LEVAGE POUR PNEUS
REIFENHEBER



Art. N700





Art. N100





Art. N90



 Sollevatore ideale per la movimentazione, lo smontaggio e rimontaggio di ruote per veicoli. I carrelli sono dotati di ruote girevoli, rulli regolabili per un supporto ottimale della ruota, telaio con baricentro ridotto per la massima stabilità, comando oleodinamico a pedale/mano per i modelli N100, N700 e comando manuale pneumatico per il modello N90.

 Lift perfect for handling, removing and reinstalling vehicle wheels. The trolleys are equipped with swivel wheels, adjustable rollers to give optimum support to the wheel, frame with low center of gravity for maximum stability. Models N100, N 700 have pedal/hand operated hydraulic controls and model N90 has manual pneumatic control.

 Appareil de levage idéal pour manutentionner, démonter et remonter les roues des véhicules. Les chariots sont équipés de roulettes pivotantes, de rouleaux réglables pour supporter la roue d'une façon optimale, d'un châssis au centre de gravité réduit pour le maximum de stabilité, commande hydraulique par pédale/manuelle pour les modèles N100, N700 et d'une commande manuelle pneumatique pour le modèle N90.

 Idealer Heber für das Handhaben, Demontieren und Montieren von Rädern für Fahrzeuge. Ausgestattet sind die Wagen mit Drehrädern, verstellbaren Rollen für eine optimale Radauflage, Rahmen mit reduziertem Schwerpunkt für höchste Stabilität, Hydraulikantrieb mit Pedal/Handsteuerung bei den Modellen N100, N700 und manueller Druckluftantrieb bei Model N90.