

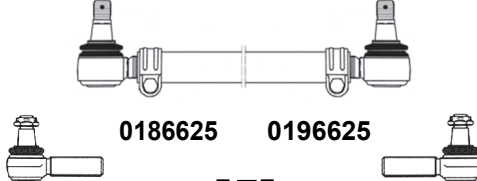

INDICE – CONTENTS

	PAGINA - PAGE
IMPIEGO DEL CATALOGO - HOW TO USE THE CATALOGUE	A-2
DESCRIZIONE DEI PARTICOLARI – ITEMS DESCRIPTION	A-3
ASTRA	1-1
DAF	2-1
IVECO	3-1
MAN	4-1
MERCEDES	5-1
NISSAN	6-1
RENAULT V.I.	7-1
SCANIA	8-1
VOLVO	9-1
CORRISPONDENZE CODICI - CROSS REFERENCE	
CODICE ORIGINALE > CODICE OCAP ORIGINAL NUMBER > OCAP NUMBER	10-1
CODICE OCAP > CODICE ORIGINALE OCAP NUMBER > ORIGINAL NUMBER	11-1

IMPIEGO DEL CATALOGO - HOW TO USE THE CATALOGUES

RIF. ORIG O.E. NUMBER	RIF. ORIG O.E. NUMBER	NOTE REMARKS	MODELLO/DESCRIZIONE MODEL/DESCRIPTION
0186622 [1] 	42493781 [2] 2966688	M=30x1,5 RHT L= 115 m=20x1,5	EUROARGO: 120E15/E18/E23 130E15/E18/E23 150E15/E23/E27 R 260E23T-280E23T 320E27T
0186622  0186625 0196625 [5]	98458724 98427667	L=1636 [3]	EUROTECH: 180E24/27/30 190E24/27/30 400E30/34 [4]
0600918 	3812A4 9566950880	M=14x1,5 RHT	SNODO ASSIALE – AXIAL JOINT

	I	GB	D	F	E
[1]	Riferimento OCAP	OCAP References	OCAP Nummern	Références OCAP	Referencias OCAP
[2]	Riferimento originale	Original number	Originalnummern	Numero original	Numero original
[3]	Note	Remarks	Bemerkungen	Remarques	Observaciones
[4]	Modello/Descrizione	Model/Description	Modell/Beschreibung	Modell/Description	Modelo/Descripción
[5]	Teste di ricambio	Tie rod ends	Kugelgelenk	Rotules	Ròtulas

FABBRICANTI, MARCHE E CODICI PRODOTTI SONO ELENCATI SOLO PER L'IDENTIFICAZIONE DEL VEICOLO PER CUI I PARTICOLARI SONO ADATTI

ALL VEHICLE MANUFACTURES NAMES AND ORIGINAL PART NUMBER IN THIS CATALOG ARE FOR REFERENCE PURPOSES ONLY



DIE GENANNTEN ORIGINAL NRN. DIENEN NUR ZU VERGLEICHSZWECKEN

LE NOMS DES FABRICANTS DE VEHICULES AINSI QUE LES NUMEROS DE PIECES INDIQUES DANS CE CATALOGUE DOIVENT ETRE UTILISES UNIQUEMENT COMME REFERENCES

TODOS LAS DENOMINACIONES DE FABRICANTES Y NUMEROS DE PIEZAS ORIGINALES INDICADOS EN ESTE CATALOGO SON UNICAMENTE PARA USO DE CONPARACION

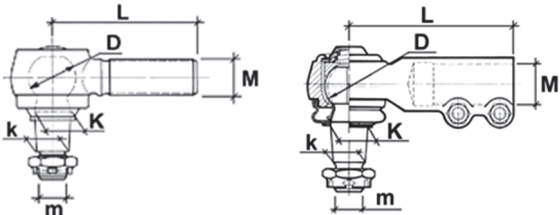
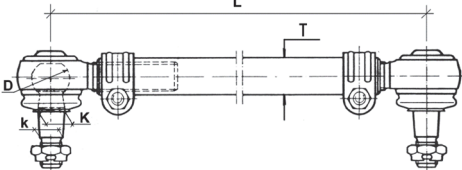
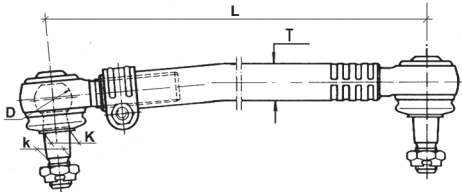
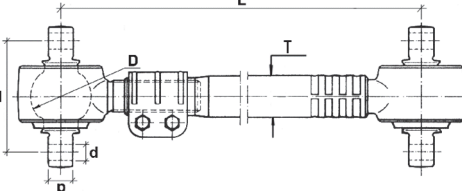
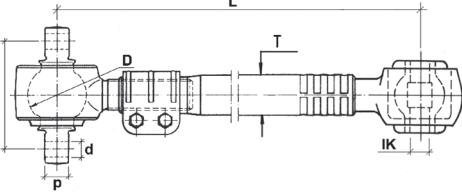
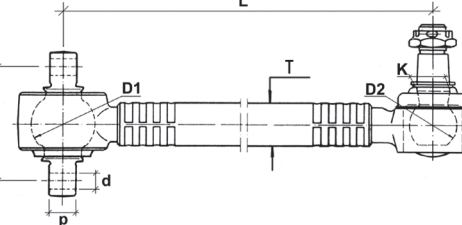
DESCRIZIONE DEI PARTICOLARI - ITEMS DESCRIPTION

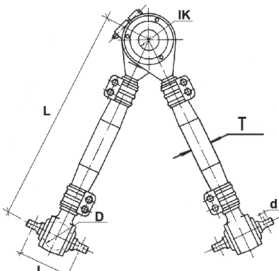
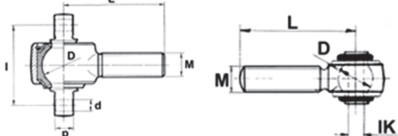
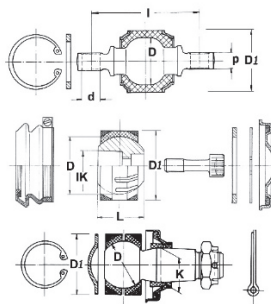
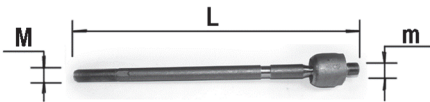
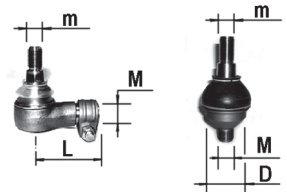

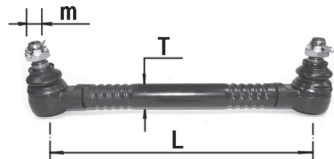

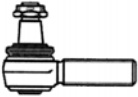
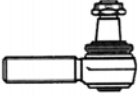

<p style="text-align: center;">Testa / Tie rod end</p> 	<p>M = Filetto gambo - Shank thread m = Filetto perno - Pin thread L = Lunghezza testa sterzo – Tie rod end length D = Diametro sfera - Ball pin diameter K = Diametro cono base perno - Taper diameter max. size k = Diametro cono inizio perno - Taper diameter min. size</p>
<p style="text-align: center;">Barra accoppiamento / Tie rod</p> 	<p>L = Lunghezza barra accoppiamento – Tie rod length D = Diametro sfera - Ball pin diameter K = Diametro cono base perno - Taper diameter max. size k = Diametro cono inizio perno - Taper diameter min. size T = Diametro tubo - Tube diameter</p>
<p style="text-align: center;">Tirante longitudinale / Drag link</p> 	<p>L = Lunghezza tirante – Drag link length D = Diametro sfera - Ball pin diameter K = Diametro cono base perno - Taper diameter max. size k = Diametro cono inizio perno - Taper diameter min. size T = Diametro tubo - Tube diameter</p>
<p style="text-align: center;">Barra di reazione / Torque rod</p> 	<p>L = Lunghezza barra di reazione – Torque rod length D = Diametro sfera - Ball pin diameter d = Diametro foro perno - Hole pin diameter p = Spessore perno – Thickness of the pin I = Interasse fori perno - Pin hole spacing T = Diametro tubo - Tube diameter</p>
<p style="text-align: center;">Barra reazione / Torque rod</p> 	<p>L = Lunghezza barra di reazione – Torque rod length D = Diametro sfera - Ball pin diameter d = Diametro foro perno - Hole pin diameter p = Spessore perno - Thickness of the pin I = Interasse fori perno - Pin hole spacing IK = Diametro foro sfera - Hole ball pin diameter T = Diametro tubo - Tube diameter</p>
<p style="text-align: center;">Barra reazione / Torque rod</p> 	<p>L = Lunghezza barra di reazione – Torque rod length D1 = Diametro sfera - Ball pin diameter D2 = Diametro sfera - Ball pin diameter K = Diametro cono base perno - Taper diameter max. size d = Diametro foro perno - Hole pin diameter p = Spessore perno - Thickness of the pin I = Interasse fori perno - Pin hole spacing T = Diametro tubo - Tube diameter</p>

<p>Barra reazione triangolare/ Triangular torque rod</p> 	<p>L = Lunghezza barra di reazione – Torque rod length D = Diametro sfera - Ball pin diameter d = Diametro foro perno - Hole pin diameter p = Spessore perno - Thickness of the pin l = Interasse fori perno - Pin hole spacing IK = Diametro foro sfera - Hole ball diameter T = Diametro tubo - Tube diameter T = Diametro tubo - Tube diameter</p>
<p>Testa barra / Ball joint</p> 	<p>L = Lunghezza testa – Ball joint length M = Filetto gambo testa - Head shank thread D = Diametro sfera - Ball pin diameter d = Diametro foro perno - Hole pin diameter p = Spessore perno - Thickness of the pin l = Interasse fori perno - Pin hole spacing IK = Diametro foro sfera - Hole ball diameter</p>
<p>Kit riparazione / Repair kit</p> 	<p>D = Diametro sfera - Ball pin diameter D1 = Diametro kit – Kit diameter d = Diametro foro perno - Hole pin diameter p = Spessore perno - Thickness of the pin l = Interasse fori perno - Pin hole spacing K = Diametro cono base perno - Taper diameter max. size IK = Diametro foro sfera - Hole ball pin diameter L = Lunghezza sfera - Ball pin length</p>
<p>Snodo assiale / Axial joint</p> 	<p>L = Lunghezza snodo assiale – Axial joint length M = Filetto perno - Pin thread m = Filetto corpo - Shape thread</p>
<p>Snodo sospensione / Ball joint</p> 	<p>M = Filetto snodo sospensione - Ball joint thread m = Filetto perno - Pin thread L = Lunghezza da centro testa a fine gambo - Length from head center to end of stick</p>
<p>Braccio oscillante / Track control arm</p> 	
<p>Stabilizzatore / Stabilizer link</p> 	<p>L = Lunghezza stabilizzatore – Stabilizer link length m = Filetto perno - Pin thread T = Diametro tubo - Tube diameter</p>

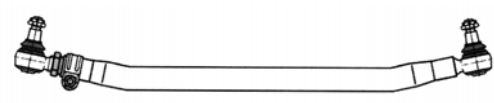
TESTE STERZO - TIE RODS END

RIF. OCAP OCAP REF.	RIF. ORIG O.E. NUMBER	NOTE REMARKS	MODELLO / DESCRIZIONE MODEL / DESCRIPTION
<p>0186422</p> 	<p>101347 113251</p>	<p>L= 135</p> <p>M= 38x1,5 RHT</p>	<p>BM</p>
<p>0196422</p> 	<p>101348 113252</p>	<p>L= 135</p> <p>M= 38x1,5 LHT</p>	<p>BM</p>





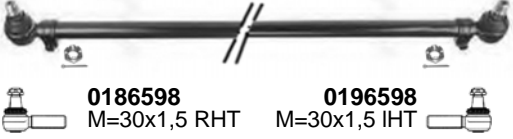

BARRE ACCOPPIAMENTO - TIE RODS

RIF. OCAP OCAP REF.	RIF. ORIG O.E. NUMBER	NOTE REMARKS	MODELLO / DESCRIZIONE MODEL / DESCRIPTION
<p>0506432</p>  <p>0186424 M=30x1,5 RHT</p>	<p>1286343</p>	<p>L=1698 T=52</p>	<p>CF 75 - 85 XF 95 - 105</p>
<p>0507933</p>  <p>0186424 M=30x1,5 RHT 0196424 M=30x1,5 LHT</p>	<p>1270853 1353391</p>	<p>L=1698 T=40</p>	<p>CF 65 - 75 - 85 XF 95 - 105</p>
<p>0507934</p>  <p>0186424 M=30x1,5 RHT 0196424 M=30x1,5 LHT</p>	<p>1337644 0288281 288281 1270854</p>	<p>L=1734 T=40</p>	<p>CF 65 - 75 - 85 + XF 95 - 105</p>
<p>0507942</p>  <p>0187843 M=30x1,5 RHT</p>	<p>1297572 1361155</p>	<p>L=1522 T=52</p>	<p>CF 75 - 85 XF 95 - 105</p>
<p>0507949</p>  <p>0186598 M=30x1,5 RHT 0196598 M=30x1,5 LHT</p>	<p>1700000</p>	<p>L=1690 T=40</p>	<p>CF 65 - 75 - 85 XF 95 - 105</p>
<p>0509438</p>  <p>0187894 M=30x1,5 RHT</p>	<p>1732973</p>	<p>L=1698 T=52</p>	<p>CF 75 - 85 XF 105</p>







BARRE ACCOPPIAMENTO - TIE RODS

RIF. OCAP OCAP REF.	RIF. ORIG O.E. NUMBER	NOTE REMARKS	MODELLO / DESCRIZIONE MODEL / DESCRIPTION
<p>0509469</p>  <p>0186598 M=30x1,5 RHT</p> <p>0196598 M=30x1,5 IHT</p>	<p>1807596</p>	<p>L=1766 T=40</p>	<p>XF FA-FAD-FAR-FAS-FT-FTP-FTR-FTS</p>





TIRANTI LONGITUDINALI - DRAG LINKS

RIF. OCAP OCAP REF.	RIF. ORIG O.E. NUMBER	NOTE REMARKS	MODELLO / DESCRIZIONE MODEL / DESCRIPTION
<p>0506430</p>  <p>0186598 M=30x1,5 RHT</p>	<p>0094038 0554765 094038 554765 94038 525443</p>	<p>L=995 T=52</p>	<p>95 XF</p>
<p>0506433</p>  <p>0186424 M=30x1,5 RHT</p>	<p>1291060 1385499 1351734</p>	<p>L=1005 T=52</p>	<p>XF 95</p>
	<p>1451122 1392640</p>	<p>L=1977 T=52</p>	<p>CF 75 - CF 85</p>
<p>0507937</p>  <p>0186598 M=30x1,5 RHT 0196598 M=30x1,5 LHT</p>	<p>1451118</p>	<p>L=860 T=38</p>	<p>CF 75 - 85 - XF 95 - 105</p>
<p>0507938</p>  <p>0186598 M=30x1,5 RHT</p>	<p>1451129 1380417</p>	<p>L=860 T=36</p>	<p>CF 75 - CF 85</p>
<p>0507947</p>  <p>0186598 M=30x1,5 RHT</p>	<p>1395994</p>	<p>L=991 T=50</p>	<p>CF 85 XF 95 - 105</p>









TIRANTI LONGITUDINALI - DRAG LINKS

RIF. OCAP OCAP REF.	RIF. ORIG O.E. NUMBER	NOTE REMARKS	MODELLO / DESCRIZIONE MODEL / DESCRIPTION
<p>0507948</p>  <p>0186598 M=30x1,5 RHT</p>	<p>1602821 1448063 1363859</p>	<p>L=867 T=50</p>	<p>CF 65 - 75 - 85</p>
<p>0509459</p>  <p>0186598 M=30x1,5 RHT</p>	<p>1902942 1828523</p>	<p>L=785 T=52</p>	<p>CF - XF</p>
<p>0509464</p>  <p>0186598 M=30x1,5 RHT</p>	<p>1448064 1373878</p>	<p>L=865 T=52</p>	<p>CF 75 - 85</p>
<p>0509474</p>  <p>0186598 M=30x1,5 RHT</p>	<p>1426101</p>	<p>L=1004 T=52</p>	<p>CF 85 XF 95-105</p>
<p>0509939</p>  <p>0197928 M=30x1,5 LHT</p>	<p>1700913 1406600</p>	<p>L=900 T=38</p>	<p>LF 45</p>
<p>0509941</p>  <p>0196424 M=30x1,5 LHT</p>	<p>1401937</p>	<p>L=910 T=40</p>	<p>LF 55</p>

TIRANTI LONGITUDINALI - DRAG LINKS

RIF. OCAP OCAP REF.	RIF. ORIG O.E. NUMBER	NOTE REMARKS	MODELLO / DESCRIZIONE MODEL / DESCRIPTION
0509943 	1405309 1403898	L=926 T=46	CF 65 - LF 55
0509946   0186598 M=30x1,5 RHT	1395993	L=996 T=38	XF 95 - 105
0509947   0186598 M=30x1,5 RHT	1395995	L=1000 T=52	XF 95 - 105



TESTE STERZO - TIE RODS END

RIF. OCAP OCAP REF.	RIF. ORIG O.E. NUMBER	NOTE REMARKS	MODELLO / DESCRIZIONE MODEL / DESCRIPTION
0186168 	1604248 1705907 1902997 1703472	L=150 M=28x1,5 RHT	LF 45
0186424 	1331925 698609 607999 1229944 1326896	L=115 M=30x1,5 RHT	CF 65 - 75 M 2000 XF 95 - 105
0186598 	688450 607981 257890 1149907 1152350 1257890 1603789 1618048 ACHF060	L=120 M=30x1,5 RHT	CF 65 - 75 - 85 XF 95
0196598 	1228115 696225 607053 1329134 1611088 696205	L=120 M=30x1,5 LHT	CF 65 - 75 - 85 XF 95
0186613 	1373135 1743554 607451 ACU9242 0110197	L=105 M=28x1,5 RHT	CF 65 - 75 - 85 XF 95
0196613 	1743594 1373137 607452	L=105 M=28x1,5 LHT	CF 65 - 75 - 85 XF 95
0186758 	696226 607073	L=135 M=30x1,5 RHT	CF 65 - 75 - 85
0187723 	1603883 1149875	L=150 M=30x1,5 RHT	LF 55

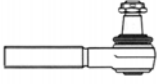
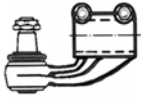



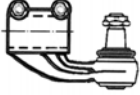
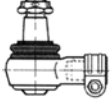

TESTE STERZO - TIE RODS END

RIF. OCAP OCAP REF.	RIF. ORIG O.E. NUMBER	NOTE REMARKS	MODELLO / DESCRIZIONE MODEL / DESCRIPTION
0187803 	ACU9240 AFRA888	L=180 M=28x1,5 RHT	45 FA
0197803 	ACU9239	L=180 M=28x1,5 LHT	45 FA
0188994 	1685552	L=140 M=30x1,5 RHT	CF 65 - 75 - 85 LF 55 XF 95 - 105
0196168 	1604247 1703473 1902296 1705908	L=150 M=28x1,5 LHT	LF 45
0196424 	1319838 607998 1319838 1315447 ACHF241 1332123 311300	L=115 M=30x1,5 LHT	CF 65 - 75
0196608 	1689605	L=115 M=28x1,5 LHT	LF 45
0197928 	1401942 AFRA635	L=120 M=30x1,5 LHT	LF 45 - LF FA
0286428 	0067389 67389	L=130 M=48x1,5 RHT	65 CF - 75 CF - 85 CF

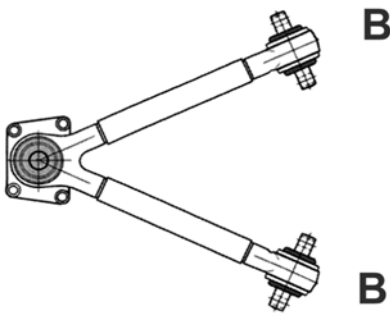

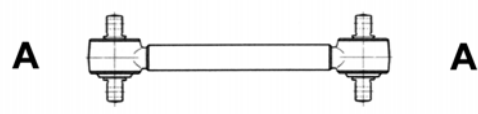

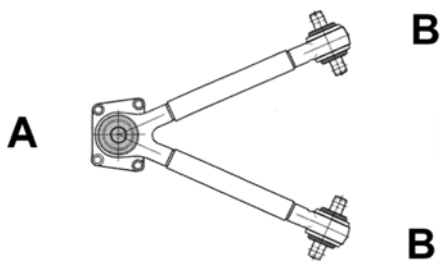

TESTE STERZO - TIE RODS END

RIF. OCAP OCAP REF.	RIF. ORIG O.E. NUMBER	NOTE REMARKS	MODELLO / DESCRIZIONE MODEL / DESCRIPTION
0296428 	0067303 67303	L=130 M=48x1,5 LHT	65 CF - 75 CF - 85 CF
0287291 	8178244	L=95 M=24x1,5 RHT	LF 55
0287503 	0273203 1399724	L=95 M=22x1,5 RHT	CF 75-85 + XF 95

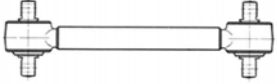

BARRE DI REAZIONE - TORQUE RODS

RIF. OCAP OCAP REF.	RIF. ORIG O.E. NUMBER	NOTE REMARKS	MODELLO / DESCRIZIONE MODEL / DESCRIPTION
<p>0807489</p> 	<p>0080521 1793875 1390932 1368270 1361651</p>	<p>L=608 T=48 d=23</p>	<p>CF 65 - 75 -85</p>
<p>0907489</p> 	<p>0698724</p>	<p>L=152 d=23 p=24 D=70</p>	
<p>0807501</p> 	<p>1361649 1361650 1656428 1817809 1663207 0267743</p>	<p>L=605 T=48 d=21</p>	<p>CF 75 - 85 LF 55 XF 95 - 105</p>
<p>0907359</p> 	<p>0513757 0691709</p>	<p>l=130 p=30 D=70 d=21</p>	
<p>0807525</p> 	<p>0649819 1620437 1793877</p>	<p>L1=550 T=58 d=23 L2=550</p>	<p>CF 75 - 85 XF 95 - 105</p>
<p>0907525</p> 	<p>0696320</p>	<p>L=61 IK=56 D=80</p>	





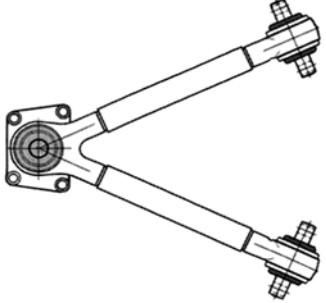

BARRE DI REAZIONE - TORQUE RODS

RIF. OCAP OCAP REF.	RIF. ORIG O.E. NUMBER	NOTE REMARKS	MODELLO / DESCRIZIONE MODEL / DESCRIPTION
0907529 B 	0696321	l=152 p=35 D=95 d=23	
0807555  B	1261101	L=390 T=50 d1=21 - d2=19	CF 75 - 85 XF 95 - 105
0907258 B 	1271124 2980884 81432206132 81432206108	l=130 p=30 D=65 d=19	
0807927 A  A	1294251	L=606 T=42	CF 75 - 85
0907927 A 	1321936	p=24 D=67 d=19	
0807930 A  B	1793876 1620436 1361652	L=608,2 T=48 d=23	CF 75 - 85
0907525  A	0696320	L=61 IK=56 D=80	

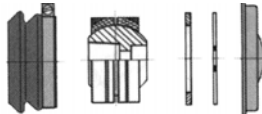

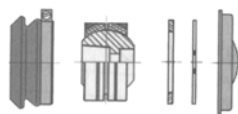



BARRE DI REAZIONE - TORQUE RODS

RIF. OCAP OCAP REF.	RIF. ORIG O.E. NUMBER	NOTE REMARKS	MODELLO / DESCRIZIONE MODEL / DESCRIPTION
<p>0907489</p> <p>B</p> 	<p>0698724</p>	<p>L=152 d=23 p=24 D=70</p>	
<p>0809447</p> <p>A</p>  <p>0909447</p> <p>A</p> 	<p>2141265</p> <p>1676776</p>	<p>L=609 T=46</p> <p>D=108</p>	<p>CF 75-85 LF 55 XF 95 - 105</p>

KIT DI SOSPENSIONE - SUSPENSION KITS

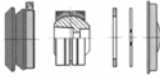
RIF. OCAP OCAP REF.	RIF. ORIG O.E. NUMBER	NOTE REMARKS	MODELLO / DESCRIZIONE MODEL / DESCRIPTION
0907257 	1398368 0691704 0069600	L=50 IK=38 D=65	CF 65 - 75 - 85 LF 55 XF 95
0907258 	1271124 2980884 81432206132 81432206108	l=130 p=30 D=65 d=19	CF 75 - 85 XF 95 - 105
0907296 	1252284	l=130 p=24 D=75 d=21	CF 85
0907297 	1376730	IK=38 D=65	CF 65 - 75 - 85 XF 95
0907359 	0513757 0691709	l=130 p=30 D=70 d=21	CF 75 - 85 - 95 LF 55 XF 95 - 105
0907489 	0698724	L=152 d=23 p=24 D=70	CF 65 - 75 -85 LF 55 XF 95 - 105
0907525 	0696320	L=61 IK=56 D=80	CF 75 - 85 XF 95 - 105
0907528 	0689748	l=115 p=24 D=75 d=17	CF 75 - 85 - 95 XF 95











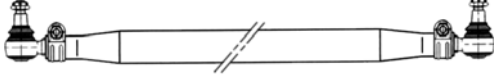

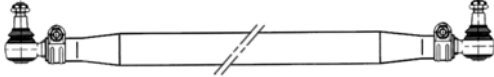
KIT DI SOSPENSIONE - SUSPENSION KITS

RIF. OCAP OCAP REF.	RIF. ORIG O.E. NUMBER	NOTE REMARKS	MODELLO / DESCRIZIONE MODEL / DESCRIPTION
0907529 	0696321	l=152 p=35 D=95 d=23	CF 65 - 75 - 85 XF 95 - 105
0907595 	0693778		CF 75 - 85 XF 95 - 105
0907683 	0696320		CF 75 - 85 XF 95 - 105
0907757 	1271124	D=65	CF 75 - 85 XF 95 - 105
0907927 	1321936	p=24 D=67 d=19	CF 75 - 85
0909447 	1676776	D=108	CF 75-85 LF 55 XF 95 - 105

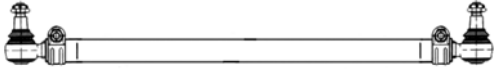

TESTE COMANDO CAMBIO - GEAR BOX CONTROL BALL JOINTS

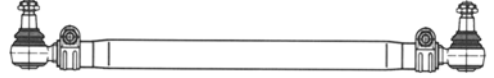
RIF. OCAP OCAP REF.	RIF. ORIG O.E. NUMBER	NOTE REMARKS	MODELLO / DESCRIZIONE MODEL / DESCRIPTION
<p>0187228</p> 	<p>386930 0386930 542477</p>	<p>L=85</p> <p>M=14x1,5 RHT</p>	<p>95 XF - F</p>





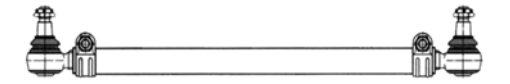







BARRE ACCOPPIAMENTO - TIE RODS

RIF. OCAP OCAP REF.	RIF. ORIG O.E. NUMBER	NOTE REMARKS	MODELLO / DESCRIZIONE MODEL / DESCRIPTION
0506847   0186598 M=30x1,5 RHT 0196598 M=30x1,5 LHT 	42003432 41036943 41042938	L=1640 T=46	TURBOSTAR TURBOTECH
0506932   0186598 M=30x1,5 RHT 0196598 M=30x1,5 LHT 	41005450 8163773 41005451 41036944 41042730	L=1641 T=48	EUROTECH EUROSTAR CURSOR EUROTRAKKER CURSOR TRAKKER STRALIS
0506950   0186424 M=30x1,5 RHT 0196424 M=30x1,5 LHT 	98402553 500307556	L=1490 T=38	EURO CARGO - EURO CARGO TECTOR
0506953   0186424 M=30x1,5 RHT 0196424 M=30x1,5 LHT 	4854871	L=1584 T=42	EURO CARGO - EURO CARGO TECTOR
0506994   0186598 M=30x1,5 RHT 0196598 M=30x1,5 LHT 	98470968	L=1590 T=42	EURO CARGO I-III





BARRE ACCOPPIAMENTO - TIE RODS

RIF. OCAP OCAP REF.	RIF. ORIG O.E. NUMBER	NOTE REMARKS	MODELLO / DESCRIZIONE MODEL / DESCRIPTION
<p>0507288</p>  <p>0186598 0196598 M=30x1,5 RHT M=30x1,5 LHT</p>	<p>8165309</p>	<p>L=1560 T=48</p>	<p>EUROCARGO EUROTRAKKER - EUROTRAKKER CURSOR TRAKKER</p>
<p>0507290</p>  <p>0186613 0196613 M=28x1,5 RHT M=28x1,5 LHT</p>	<p>8582320 8564386</p>	<p>L=1348 T=34</p>	<p>GAMMA ZETA</p>
<p>0507366</p>  <p>0186598 0196598 M=30x1,5 RHT M=30x1,5 LHT</p>	<p>41033237 41032608</p>	<p>L=1477 T=48</p>	<p>EUROTECH EUROSTAR STRALIS TRAKKER</p>
<p>0509421</p>  <p>0186598 0196598 M=30x1,5 RHT M=30x1,5 LHT</p>	<p>504144266 5801692437</p>	<p>L=1620 T=42</p>	<p>EUROCARGO I - II - III</p>



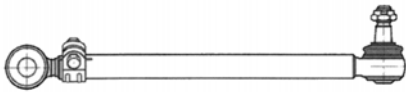
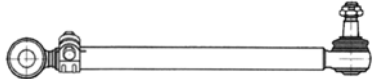





TIRANTI LONGITUDINALI - DRAG LINKS

RIF. OCAP OCAP REF.	RIF. ORIG O.E. NUMBER	NOTE REMARKS	MODELLO / DESCRIZIONE MODEL / DESCRIPTION
0506726   0186612 M=24x1,5 RHT	8591222 8590479 8558522	L=830 T=30	GAMMA ZETA
0506737   0186612 M=24x1,5 RHT	8591219 8564248 8590443	L=765 T=30	GAMMA ZETA
0506840   0186598 M=30x1,5 RHT	42087842 4747961 4747960	L=982 T=48	TURBOSTAR TURBOTECH
0506855   0186598 M=30x1,5 RHT	42001326 42001325 42086458	L=890 T=46	190
0506887   0186424 M=30x1,5 RHT	8590435	L=715 T=38	GAMMA ZETA
0506894   0186598 M=30x1,5 RHT	98446354	L=901 T=50	EUROTECH

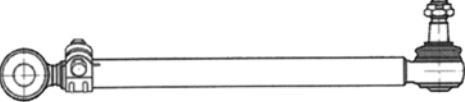

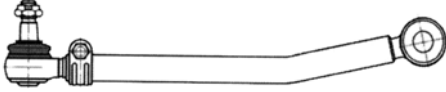



TIRANTI LONGITUDINALI - DRAG LINKS

RIF. OCAP OCAP REF.	RIF. ORIG O.E. NUMBER	NOTE REMARKS	MODELLO / DESCRIZIONE MODEL / DESCRIPTION
<p>0506897</p>  <p>0186598 M=30x1,5 RHT</p>	<p>41016958 8135446 41005472</p>	<p>L=832 T=52</p>	<p>STRALIS EUROSTAR</p>
<p>0506927</p>  <p>0186598 M=30x1,5 RHT</p>	<p>41016964 41005466 8136061 41017272</p>	<p>L=698 T=40</p>	<p>EUROTRAKKER</p>
<p>0506931</p>  <p>0186598 M=30x1,5 RHT</p>	<p>41005463 8131582 8132397 41042919</p>	<p>L=953 T=52</p>	<p>EUROTECH EUROSTAR EUROTRAKKER EUROTRAKKER CURSOR STRALIS TRAKKER</p>
<p>0506951</p>  <p>0186424 M=30x1,5 RHT</p>	<p>98402544 98467459</p>	<p>L=822 T=40</p>	<p>EUROCARGO</p>
<p>0506952</p>  <p>0186424 M=30x1,5 RHT</p>	<p>4854874</p>	<p>L=897 T=42</p>	<p>EUROCARGO</p>
<p>0506955</p>  <p>0186598 M=30x1,5 RHT</p>	<p>42118693 42117267 42118781</p>	<p>L=1458 T=58</p>	<p>EUROCARGO I - III</p>





TIRANTI LONGITUDINALI - DRAG LINKS

RIF. OCAP OCAP REF.	RIF. ORIG O.E. NUMBER	NOTE REMARKS	MODELLO / DESCRIZIONE MODEL / DESCRIPTION
0506956   0186598 M=30x1,5 RHT	98469650 98449025	L=878 T=36	EUROCARGO - EUROCARGO TECTOR
0507207 	41032826	L=1590 T=48	EUROTRAKKER
0507287   0186598 M=30x1,5 RHT	41016961 41005469 8135492 41011470 41017269	L=824 T=52	EUROSTAR STRALIS
0507293   0186598 M=30x1,5 RHT	41005475 41006093	L=952 T=52	EUROTRAKKER EUROTRAKKER CURSOR
0507314   0186598 M=30x1,5 RHT	42118694 42115532	L=1485 T=60	EUROTRAKKER EUROTRAKKER CURSOR TRAKKER
0507365 	5801282537 5801282538	L=953 T=52	EUROSTAR EUROTECH EUROTRAKKER TRAKKER STRALIS



TIRANTI LONGITUDINALI - DRAG LINKS

RIF. OCAP OCAP REF.	RIF. ORIG O.E. NUMBER	NOTE REMARKS	MODELLO / DESCRIZIONE MODEL / DESCRIPTION
<p>0507368</p>  <p>0186598 M=30X1,5 RHT</p>	<p>504049893 5801645286</p>	<p>L=892 T=42</p>	<p>EUROCARGO TECTOR</p>
<p>0507369</p>  <p>0186598 M=30x1,5 RHT</p>	<p>500397738</p>	<p>L=959 T=36</p>	<p>EUROTECH EUROSTAR CURSOR TRAKKER STRALIS</p>
<p>0507370</p>  <p>0186598 M=30x1,5 RHT</p>	<p>41226580 41215165</p>	<p>L=959 T=52</p>	<p>EUROTRAKKER EUROTRAKKER CURSOR TRAKKER</p>
<p>0507850</p>  <p>0186598 M=30x1,5 RHT</p>	<p>98473328</p>	<p>L=966 T=50</p>	<p>EUROCARGO</p>
<p>0507851</p>  <p>0186598 M=30x1,5 RHT</p>	<p>98493054</p>	<p>L=887 T=40</p>	<p>EUROCARGO</p>
<p>0507859</p>  <p>0186424 M=30x1,5 RHT</p>	<p>500324282</p>	<p>L=785 T=40</p>	<p>EUROCARGO</p>

TIRANTI LONGITUDINALI - DRAG LINKS

RIF. OCAP OCAP REF.	RIF. ORIG O.E. NUMBER	NOTE REMARKS	MODELLO / DESCRIZIONE MODEL / DESCRIPTION
0507866   0186598 M=30x1,5 RHT 0196598 M=30x1,5 LHT 	504034521	L=1570 T=42	EUROCARGO I-III
0507904   0186598 M=30x1,5 RHT	41298449 41028269	L=887 T=52	EUROTRAKKER TRAKKER



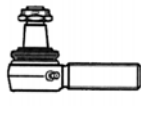





TESTE STERZO - TIE RODS END

RIF. OCAP OCAP REF.	RIF. ORIG O.E. NUMBER	NOTE REMARKS	MODELLO / DESCRIZIONE MODEL / DESCRIPTION
0186424 	4833827 8122754 42493781 2966688 42495718 2966891 4833820	L=115 M=30x1,5 RHT	EUROCARGO - EUROCARGO TECTOR GAMMA ZETA
0196424 	4833828 2984511 4833821 8122755	L=115 M=30x1,5 LHT	EUROCARGO
0186598 	4833829 4833822 42483386 4802443 93163828 93190752	L=120 M=30x1,5 RHT	EUROTECH EUROSTAR EUROCARGO EUROTRAKKER STRALIS
0196598 	4833830 4833823 42489395 42489574 4802444	L=120 M=30x1,5 LHT	EUROCARGO EUROTECH EUROSTAR EUROTRAKKER STRALIS
0186599 	4688948	L=120 M=38x1,5 RHT	TURBOSTAR - TURBOTECH
0196599 	4688949	L=120 M=38x1,5 LHT	TURBOSTAR
0186608 	4688941 8582332 7167757 8565366	L=115 M=28x1,5 RHT	GAMMA ZETA
0196603 	4018037	L=115 M=25x1,5 LHT	GAMMA ZETA

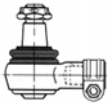

TESTE STERZO - TIE RODS END

RIF. OCAP OCAP REF.	RIF. ORIG O.E. NUMBER	NOTE REMARKS	MODELLO / DESCRIZIONE MODEL / DESCRIPTION
0186612 	93194626 8558527 42487165	L=105 M=24x1,5RHT	OM
0196612 	8558524	L=105 M=24x1,5LHT	OM
0186613 	42484886 4833825 8193645 8558533 8582322 2966321 2966635	L=105 M=28x1,5 RHT	GAMMA ZETA
0196613 	42484887 4833826 8123394 8193646 8558536 2969507	L=105 M=28x1,5 LHT	GAMMA ZETA
0186614 	9009501 4579231	L=98 M=18x1,5 RHT	NC
0196614 	9009503 4579232	L=98 M=18x1,5 LHT	OM
0186758 	42537936 8122752 4833829 042489573	L=135 M=30x1,5 RHT	EUROCARGO TURBOTECH EUROTRAKKER
0187158 	61595957 *	L=105 M=25x1,5 RHT	100 NC





TESTE STERZO - TIE RODS END

RIF. OCAP OCAP REF.	RIF. ORIG O.E. NUMBER	NOTE REMARKS	MODELLO / DESCRIZIONE MODEL / DESCRIPTION
0188994 	42538384	L=140 M=30x1,5 RHT	EUROCARGO I-II-III EUROTRAKKER TURBOTECH
0196608 	8582333	L=115 M=28x1,5 LHT	GAMMA ZETA
0280515 	1903652 93804059 93800662	L=80 M=16x1,5 RHT	DAILY I-II
0287238 	55175540	L=91 M=30x1,5 RHT	EUROTECH EUROSTAR
0287320 	42530316 42538047	L=86 M=30x1,5 RHT	EUROTRAKKER TRAKKER
0287360 	42533101	L=90 M=26x1,5 RHT	EUROTECH EUROSTAR STRALIS
0287361 	42533073	L=75 M=26x1,5 RHT	EUROTECH EUROSTAR STRALIS
0287552 	42534911 93827647 42556991	L=80 M=16x1,5 RHT	DAILY III-IV-V
0287906 	42533102	L=80 M=26x1,5 RHT	EUROTECH EUROSTAR STRALIS TRAKKER



TESTE STERZO - TIE RODS END

RIF. OCAP OCAP REF.	RIF. ORIG O.E. NUMBER	NOTE REMARKS	MODELLO / DESCRIZIONE MODEL / DESCRIPTION
0289425 	42569563	L=109 M=16x1,5 RHT	DAILY VI
0289426 	42569562	L=87 M=16x1,5 RHT	DAILY VI
0289923 	42538048 42530447	L=90 M=36X1,5 RHT	TRAKKER



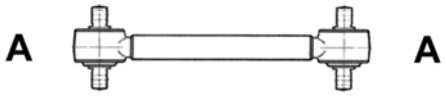
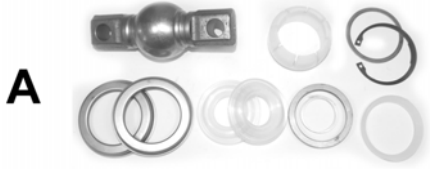

SNODI ASSIALI - AXIAL JOINTS

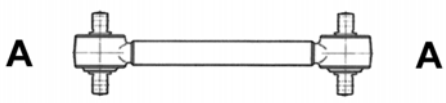
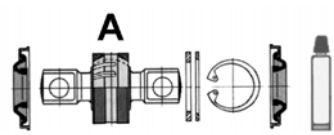
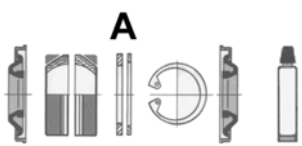
RIF. OCAP OCAP REF.	RIF. ORIG O.E. NUMBER	NOTE REMARKS	MODELLO / DESCRIZIONE MODEL / DESCRIPTION
0600516 	9983325	L=310 M=16x1,5 RHT	DAILY I - II
0602749 	2992593	L=367 M=16x1,5 RHT	DAILY III - IV - V
0606927 	7820249212	M=16x1,5 RHT	DAILY I - II
0607552 	42532977 99463268	L=348 M=16x1,5 RHT	DAILY III - IV
0609422 	42569566	L=348 M=18x1,5 RHT	DAILY VI



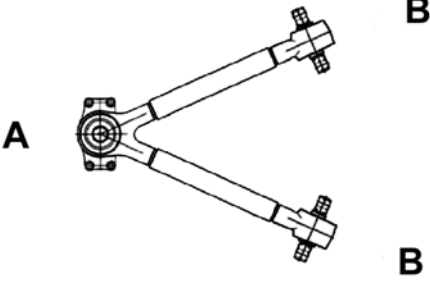
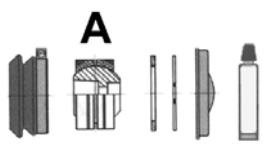
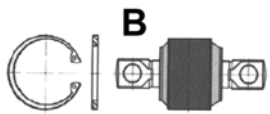



BARRE DI REAZIONE - TORQUE RODS

RIF. OCAP OCAP REF.	RIF. ORIG O.E. NUMBER	NOTE REMARKS	MODELLO / DESCRIZIONE MODEL / DESCRIPTION
<p>0807207</p> 	4714134	L=583 d=19	TURBOSTAR TURBOTECH
<p>0907258</p> 	2980884	l=130 p=30 D=65 d=19	
<p>0907757</p> 	-	D=65	
<p>0807209</p> 	42125057	L=582 d=19	TURBOSTAR TURBOTECH
<p>0907578</p> 	93161371	l=130 D=65 d=19	
<p>0907586</p> 	0005861533 093161371	D=65	



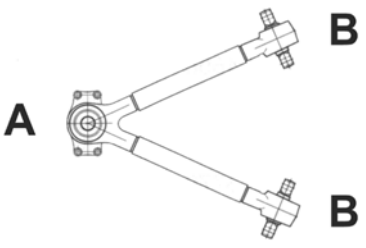
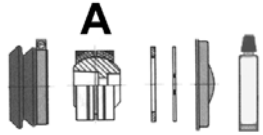

BARRE DI REAZIONE - TORQUE RODS

RIF. OCAP OCAP REF.	RIF. ORIG O.E. NUMBER	NOTE REMARKS	MODELLO / DESCRIZIONE MODEL / DESCRIPTION
<p>0807211</p> 	<p>41042050 41034479 41028598 41002770 41009665 225.027 (4)</p>	<p>L=665 T=46 d=21</p>	<p>EUROTECH EUROSTAR EUROTRAKKER STRALIS TRAKKER</p>
<p>0907297</p> 	<p>93161958 93161631</p>	<p>D=65 IK=38</p>	
<p>0907296</p> 	<p>93161960</p>	<p>l=130 p=24 D=62 d=21</p>	
<p>0807225</p> 	<p>41009961</p>	<p>L=455 T=50</p>	<p>EUROSTAR EUROTECH STRALIS</p>
<p>0907327</p> 	<p>93192361</p>	<p>l=130 p=24 D1=75 d=19</p>	
<p>0807226</p> 	<p>41033731</p>	<p>L=455 T=50</p>	<p>EUROSTAR EUROTECH STRALIS</p>
<p>0907327</p> 	<p>93192361</p>	<p>l=130 p=24 D1=75 d=19</p>	



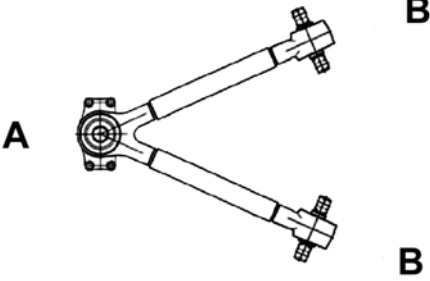
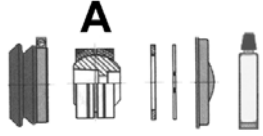
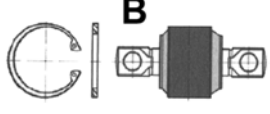



BARRE DI REAZIONE - TORQUE RODS

RIF. OCAP OCAP REF.	RIF. ORIG O.E. NUMBER	NOTE REMARKS	MODELLO / DESCRIZIONE MODEL / DESCRIPTION
0807292 	500340452 41003268	L=594 T=52 d=19,5	EUROSTAR EUROTECH STRALIS
0907327 	93192361	l=130 p=24 D1=75 d=19	
0807295 	42065332 41011006 5801304684	L=610 T=58 d=21	EUROTRAKKER EUROTRAKKER CURSOR TRAKKER
0907330 	93192619 42493431	l=152 p=24 D=80 d=21	
0807296 	504064007 41042092 98472468 41028599	L=665 d=21	EUROCARGO EUROCARGO TECTOR EUROTECH
0907297 	93161958 93161631	D=65 IK=38	
0907327 	93192361	l=130 p=24 D1=75 d=19	





BARRE DI REAZIONE - TORQUE RODS

RIF. OCAP OCAP REF.	RIF. ORIG O.E. NUMBER	NOTE REMARKS	MODELLO / DESCRIZIONE MODEL / DESCRIPTION
<p>0807299</p> 	<p>41042093 500340451</p>	<p>L=665</p> <p>d=21</p>	<p>STRALIS</p>
<p>0907299</p> 	<p>93161631 93161638</p>	<p>L=46</p> <p>IK=38</p> <p>D=65</p>	
<p>0907296</p> 	<p>93161960</p>	<p>l=130</p> <p>p=24</p> <p>D=62</p> <p>d=21</p>	
<p>0807336</p> 	<p>98472871</p>	<p>L=594</p> <p>d=19</p>	<p>EUROTECH</p>
<p>0907327</p> 	<p>93192361</p>	<p>l=130</p> <p>p=24</p> <p>D1=75</p> <p>d=19</p>	
<p>0807358</p> 	<p>41035951 98472466 41009661 41272429 8137027</p>	<p>L=590</p> <p>d=19</p>	<p>EUROCARGO TECTOR EUROTECH EUROSTAR EUROTRAKKER STRALIS TRAKKER</p>
<p>0907327</p> 	<p>93192361</p>	<p>l=130</p> <p>p=24</p> <p>D1=75</p> <p>d=19</p>	







BARRE DI REAZIONE - TORQUE RODS

RIF. OCAP OCAP REF.	RIF. ORIG O.E. NUMBER	NOTE REMARKS	MODELLO / DESCRIZIONE MODEL / DESCRIPTION
0807363 A  A 0907330 A 	41218021 5801384823 01902137 93192619 42493431	L=582 T=60 l=152 p=24 D=80 d=21	TRAKKER
0807372 	41218621 41218620	L=665 T=48 l=152/130 d=25/21	TRAKKER STRALIS
0807373 A  0907774 A 	41272706 41272707 41272706 0003502405 81432706110	L=665 T=48 l=152 d=25 l=152 p=24 D1=100 d=25	STRALIS TRAKKER
0807374 A  0907774 A 	41296730 41296731 41272706 0003502405 81432706110	L=665 T=48 l=152 d=25 l=152 p=24 D1=100 d=25	STRALIS TRAKKER

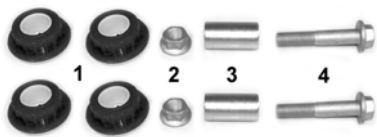
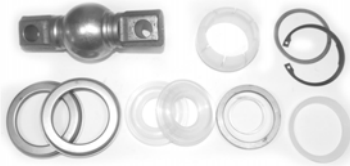

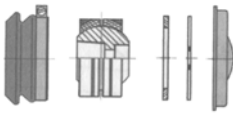



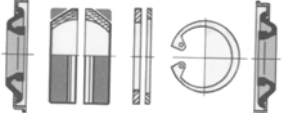

BARRE DI REAZIONE - TORQUE RODS

RIF. OCAP OCAP REF.	RIF. ORIG O.E. NUMBER	NOTE REMARKS	MODELLO / DESCRIZIONE MODEL / DESCRIPTION
<p>0807579</p>  <p>0907304</p> 	<p>42041107 41011008</p> <p>93192618 93161720 42535046</p>	<p>L=610 T=50 l=152 d=21</p> <p>l=152 p=24 D1=85 d=21</p>	<p>EUROTECH EUROSTAR EUROTRAKKER STRALIS TRAKKER</p>
<p>0809418</p> 	<p>93163964 99458576</p>	<p>L=635 T=28,7</p>	<p>EUROCARGO</p>
<p>0809448</p>  <p>0907774</p> 	<p>41272428</p> <p>41272706 0003502405 81432706110</p>	<p>L=665 T=48 l=152/130 d=25/21</p> <p>l=152 p=24 D1=100 d=25</p>	<p>TRAKKER</p>

KIT DI SOSPENSIONE - SUSPENSION KITS

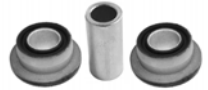
RIF. OCAP OCAP REF.	RIF. ORIG O.E. NUMBER	NOTE REMARKS	MODELLO / DESCRIZIONE MODEL / DESCRIPTION
0903144 	504039506 *		DAILY III - IV - V ASSE ANTERIORE - FRONT AXLE
0907258 	2980884	l=130 p=30 D=65 d=19	STRALIS TURBOSTAR TURBOTECH
0907296 	93161960	l=130 p=24 D=62 d=21	EUROCARGO - EUROCARGO TECTOR EUROTECH EUROSTAR EUROTRAKKER STRALIS TRAKKER
0907297 	93161958 93161631	D=65 IK=38	EUROCARGO EUROTECH EUROSTAR EUROTRAKKER STRALIS TRAKKER
0907304 	93192618 93161720 42535046	l=152 p=24 D1=85 d=21	EUROSTAR EUROTECH EUROTRAKKER TRAKKER STRALIS
0907327 	93192361	l=130 p=24 D1=75 d=19	EUROCARGO TECTOR EUROTECH EUROSTAR EUROTRAKKER STRALIS TRAKKER
0907330 	93192619 42493431	l=152 p=24 D=80 d=21	EUROTRAKKER EUROTRAKKER CURSOR TRAKKER
0907578 	93161371	l=130 D=65 d=19	TURBOSTAR TURBOTECH







KIT DI SOSPENSIONE - SUSPENSION KITS

RIF. OCAP OCAP REF.	RIF. ORIG O.E. NUMBER	NOTE REMARKS	MODELLO / DESCRIZIONE MODEL / DESCRIPTION
0907586 	0005861533 093161371	D=65	TURBOSTAR TURBOTECH
0907757 	-	D=65	TURBOSTAR TURBOTECH
0907774 	41272706 0003502405 81432706110	l=152 p=24 D1=100 d=25	STRALIS - TRAKKER
0907927 	93163617	p=24 D=67 d=19	EUROCARGO EUROTECH
0909422 	5801564281 5801564274 5801564276	L=25,2 D=17 mm.	DAILY VI ASSE ANTERIORE - FRONT AXLE
1215269 	93807641	D=32 mm.	DAILY II - III
1215270 	93807640	D=29 mm.	DAILY I-II-III-IV-V-VI
1215271 	93810239	D=37 mm.	DAILY I-II-III-IV-V







KIT DI SOSPENSIONE - SUSPENSION KITS

RIF. OCAP OCAP REF.	RIF. ORIG O.E. NUMBER	NOTE REMARKS	MODELLO / DESCRIZIONE MODEL / DESCRIPTION
1215953 	504039506		DAILY III - IV - V ASSE ANTERIORE - FRONT AXLE

BRACCI OSCILLANTI - TRACK CONTROL ARMS

RIF. OCAP OCAP REF.	RIF. ORIG O.E. NUMBER	NOTE REMARKS	MODELLO / DESCRIZIONE MODEL / DESCRIPTION
<p>0709422</p>  <p>A B</p>	5801564293		DAILY VI ANTERIORE - SUPERIORE FRONT - UPPER
<p>0409422</p>  <p>A</p>	5801564293 *		
<p>0909422</p>  <p>B</p>	<p>5801564281 5801564274 5801564276</p>	<p>L=25,2</p> <p>D=17 mm.</p>	
<p>0709423</p>  <p>A B</p>	5801564316		DAILY VI ANTERIORE - INFERIORE FRONT - LOWER
<p>0409423</p>  <p>A</p>	5801564316 *		
<p>0909422</p>  <p>B</p>	<p>5801564281 5801564274 5801564276</p>	<p>L=25,2</p> <p>D=17 mm.</p>	
<p>0787249</p>  <p>A B</p>	<p>500379802 42551297 500344888</p>		DAILY III - IV - V ANTERIORE - SUPERIORE FRONT - UPPER







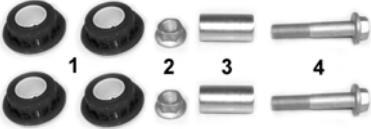

BRACCI OSCILLANTI - TRACK CONTROL ARMS

RIF. OCAP OCAP REF.	RIF. ORIG O.E. NUMBER	NOTE REMARKS	MODELLO / DESCRIZIONE MODEL / DESCRIPTION
0797249  B A	500379801 42551296 500344887 500379802		DAILY III - IV - V ANTERIORE - SUPERIORE FRONT - UPPER
0407249  A	500379801 500334713 500344888 500379802 500334714 500344887	m=16x1,5 RHT D=43,95 mm.	
1215953  B	504039506		
0787250  A B	500334716 500334486 42551289		DAILY III - IV - V ASSE ANTERIORE - INFERIORE FRONT AXLE - LOWER
0797250  B A	500334717 500334487 42551290 500334716		DAILY III - IV - V ASSE ANTERIORE - INFERIORE FRONT AXLE - LOWER
0407250  A	500334716 500334717	m=18x1,5 RHT D=44,95 mm.	
1215953  B	504039506		

BRACCI OSCILLANTI - TRACK CONTROL ARMS

RIF. OCAP OCAP REF.	RIF. ORIG O.E. NUMBER	NOTE REMARKS	MODELLO / DESCRIZIONE MODEL / DESCRIPTION
<p>0903144</p> 	<p>504039506 *</p>		<p>DAILY III - IV - V ASSE ANTERIORE - FRONT AXLE</p>



SNODI SOSPENSIONI - SUSPENSION JOINTS

RIF. OCAP OCAP REF.	RIF. ORIG O.E. NUMBER	NOTE REMARKS	MODELLO / DESCRIZIONE MODEL / DESCRIPTION
0280517 	93802209 93804060 500310933	L=72 m=18x1,5 RHT M=20x1,5 RHT	DAILY I-II-III-IV-V-VI
0286616 	500337201 8580735	L=80 m=18x1,5 RHT M=20x1,5 RHT	DAILY II - III
0400518 	93802242 93807545 93807320	m=18x1,5 RHT M=20x1,5 RHT	DAILY III - IV - V - VI
0407249 	500379801 500334713 500344888 500379802 500334714 500344887	m=16x1,5 RHT D=43,95 mm.	DAILY III - IV - V ANTERIORE - SUPERIORE FRONT - UPPER
0407250 	500334716 500334717	m=18x1,5 RHT D=44,95 mm.	DAILY III - IV - V ASSE ANTERIORE - INFERIORE FRONT AXLE - LOWER
0407893 	504212586 504212584	m=18x1,5 RHT M=20x1 RHT	DAILY III-IV-V-VI
0407894 	5801378064	m=18x1,5 RHT M=20x1,5 RHT	DAILY III MOD. 90 Q.li
0409422 	5801564293 *		DAILY VI SNODO SOSPENSIONE ASSE ANTERIORE - SUPERIORE BALL JOINT FRONT AXLE - UPER

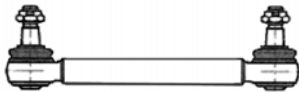

SNODI SOSPENSIONI - SUSPENSION JOINTS

RIF. OCAP OCAP REF.	RIF. ORIG O.E. NUMBER	NOTE REMARKS	MODELLO / DESCRIZIONE MODEL / DESCRIPTION
<p>0409423</p> 	<p>5801564316 *</p>		<p>DAILY VI SNODO SOSPENSIONE ASSE ANTERIORE - INFERIORE BALL JOINT FRONT AXLE - LOWER</p>



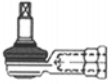
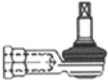

STABILIZZATORI - STABILIZERS

RIF. OCAP OCAP REF.	RIF. ORIG O.E. NUMBER	NOTE REMARKS	MODELLO / DESCRIZIONE MODEL / DESCRIPTION
0507165 	4741171	L=355	TURBOSTAR
0587871 	500383975		DAILY III ASSE ANTERIORE - FRONT AXLE
0597871 	500383976		DAILY III ASSE ANTERIORE - FRONT AXLE

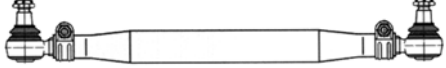

TESTE COMANDO CAMBIO - GEAR BOX CONTROL BALL JOINTS

RIF. OCAP OCAP REF.	RIF. ORIG O.E. NUMBER	NOTE REMARKS	MODELLO / DESCRIZIONE MODEL / DESCRIPTION
0181785 	42042912 41218482	L=90 M=16x1,5 RHT	EUROSTAR EUROTECH EUROCARGO I-III EUROTRAKKER STRALIS
0187228 	7981909	L=85 M=14x1,5 RHT	TURBOSTAR TURBOTECH
0281786 	41203863	L=55 M=10x1,5 RHT	EUROSTAR EUROTECH EUROTRAKKER
0291786 	42041328 41002119 42079850 42079852 41203864	L=55 M=10x1,5 LHT	EUROSTAR EUROTECH EUROTRAKKER

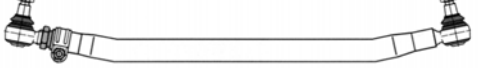
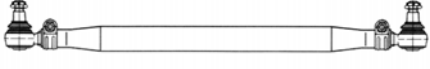





BARRE ACCOPPIAMENTO - TIE RODS

RIF. OCAP OCAP REF.	RIF. ORIG O.E. NUMBER	NOTE REMARKS	MODELLO / DESCRIZIONE MODEL / DESCRIPTION
<p>0507807</p>  <p>0186598 M=30x1,5 RHT 0196598 M=30x1,5 LHT</p>	<p>81467106353 81467116820 81467116725 81467106361 81467106354 81467106112 81467106163 81467106165 81467106198</p>	<p>L=1652 T=50</p>	<p>M2000 TGA - TGS - TGX</p>
<p>0507814</p>  <p>0186613 M=28x1,5 RHT 0196613 M=28x1,5 LHT</p>	<p>81467116894 81467116803 81467116805 81467116893 81467116896</p>	<p>L=1632 T=36</p>	<p>L2000 M2000 TGL - TGM</p>
<p>0507817</p>  <p>0186598 M=30x1,5 RHT</p>	<p>81467116736 81467106830 81467106167</p>	<p>L=1588 T=52</p>	<p>M2000 TGA - TGS</p>
<p>0507841</p>  <p>0186595 M=24x1,5 RHT 0196595 M=24x1,5 LHT</p>	<p>81467106866 81467106865 81467116717 81467116728</p>	<p>L=1645 T=30</p>	<p>L2000</p>
<p>0507843</p>  <p>0187843 M=30x1,5</p>	<p>81467116711 81467106932 81467106933 81467106934 81467106785 81467106846</p>	<p>L=1650 T=50</p>	<p>M2000</p>
<p>0507848</p>  <p>0186598 M=30x1,5 RHT 0196598 M=30x1,5 LHT</p>	<p>81466106579 81466106580 81466106583 81466106624 81466106640 81467116720</p>	<p>L=1530 T=50</p>	<p>F2000 - TGA-TGS-TGX</p>







BARRE ACCOPPIAMENTO - TIE RODS

RIF. OCAP OCAP REF.	RIF. ORIG O.E. NUMBER	NOTE REMARKS	MODELLO / DESCRIZIONE MODEL / DESCRIPTION
<p>0507915</p>  <p>0187723 M=30x1,5 RHT</p>	<p>81467116773 81467116859 81467116921 81467116860 81467116861 81467116863</p>	<p>L=1679 T=50</p>	<p>M2000 TGA - TGS - TGX</p>
<p>0509417</p>  <p>0186598 0196598 M=30x1,5 RHT M=30x1,5 LHT</p>	<p>81467116933 81467116966</p>	<p>L=1680 T=42</p>	<p>TGA - TGS - TGX</p>





TIRANTI LONGITUDINALI - DRAG LINKS

RIF. OCAP OCAP REF.	RIF. ORIG O.E. NUMBER	NOTE REMARKS	MODELLO / DESCRIZIONE MODEL / DESCRIPTION
<p>0506443</p>  <p>0186442 M=30x1,5 RHT</p>	81466106721	L=1040 T=48	F2000
<p>0506446</p>  <p>0186595 M=24x1,5 RHT</p>	85466106102	L=826 T=32	L 2000
<p>0507215</p>  <p>0186424 M=30x1,5 RHT</p>	85466106019 85466106119 85466106150 85466106219	L=910 T=40	M 2000
<p>0507408</p>  <p>0186598 M=30x1,5 RHT</p>	81466116199 81466116200 81466116206 81466116104 81466116105 81466116134 81466116135 81466116137	L=967 T=52	TGA - TGS - TGX
<p>0507409</p>  <p>0186598 M=30x1,5 RHT</p>	81466116004 81466116003 81466116005	L=1063 T=42	F 2000
<p>0507533</p>  <p>0186613 M=28x1,5 RHT</p>	85466106140 85466106021 85466106121 85466106221	L=840 T=38	L2000 M2000 TGL

TIRANTI LONGITUDINALI - DRAG LINKS

RIF. OCAP OCAP REF.	RIF. ORIG O.E. NUMBER	NOTE REMARKS	MODELLO / DESCRIZIONE MODEL / DESCRIPTION
<p>0507812</p>  <p>0186613 M=28x1,5 RHT</p>	<p>85466106246 85466106160</p>	<p>L=864 T=38</p>	TGL
<p>0507815</p>  <p>0186424 M=30x1,5 RHT</p>	<p>81466106692 81466106693 81466106695 85466106020 85466106151</p>	<p>L=960 T=42</p>	M 2000
<p>0507820</p> 	<p>81466106790 81466106791 82466106191</p>	<p>L=1749 T=52</p>	F 2000
<p>0507822</p>  <p>0186442 M=30x1,5 RHT</p>	<p>81466106779 81466106780 81466106782</p>	<p>L=1060 T=48</p>	F 2000
<p>0507839</p>  <p>0186613 M=28x1,5 RHT</p>	<p>81466106754 85466106104 81466106753 85466106031 85466106203 85466106006</p>	<p>L=825 T=38</p>	L2000
<p>0507917</p>  <p>0186758 M30x1,5 RHT</p>	<p>81466116096 81466116097 81466116198 81466116205 81466116197 81466116133 81466116132 81466116087</p>	<p>L=993 T=52</p>	TGA - TGS - TGX





TIRANTI LONGITUDINALI - DRAG LINKS

RIF. OCAP OCAP REF.	RIF. ORIG O.E. NUMBER	NOTE REMARKS	MODELLO / DESCRIZIONE MODEL / DESCRIPTION
<p>0507955</p>  <p>0186598 M30x1,5 RHT</p> <p>0196598 M30x1,5 LHT</p>	<p>81466106374 81466116019 82466106080 82466106189 82466106190</p>	<p>L=1050 T=42</p>	<p>F 2000</p>
<p>0509415</p>  <p>0186598 M=30x1,5 RHT</p>	<p>81466106813 81466116204 81466116146 81466116147 81466116148</p>	<p>L=960 T=50</p>	<p>TGA - TGS</p>
<p>0509968</p>  <p>0186613 M=28x1,5 RHT</p>	<p>85466106162</p>	<p>L=820 T=38</p>	<p>TGL</p>
<p>0509982</p> 	<p>81466116161 81466116152 81466116162 81466116163 81466116142</p>	<p>L=1800 T=62</p>	<p>TGA - TGS</p>





TESTE STERZO - TIE RODS END

RIF. OCAP OCAP REF.	RIF. ORIG O.E. NUMBER	NOTE REMARKS	MODELLO / DESCRIZIONE MODEL / DESCRIPTION
0186442 	81953016263	L=155 M=30x1,5 RHT	E2000 F2000
0186595 	81953016142 81953016303 81953016321 81953010077 81953016134	L=95 M=24X1,5 RHT	L2000 M2000
0196595 	81953016141 81953016322 81953016304 81953010078	L=95 M=24X1,5 LHT	L2000 M2000
0186613 	81953016328 81953016358 81953016249 81953016060 81953016135 81953016140	L=105 M=28x1,5 RHT	L2000 M2000 TGL
0196613 	81953010079 81953016222 81953016139	L=105 M=28x1,5 LHT	L2000 M2000 TGL - TGM
0186758 	81953010022	L=135 M=30x1,5 RHT	TGA - TGS - TGX
0187723 	81.95301.6288 81953016288	L=150 M=30x1,5 RHT	L2000 M2000 TGA - TGM - TGS - TGX
0187843 	81953016270	L=141 M=30x1,5 RHT	L2000 M2000





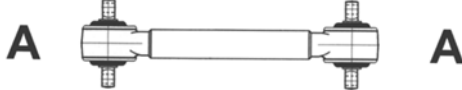
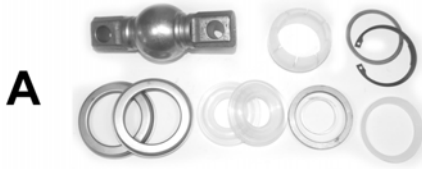

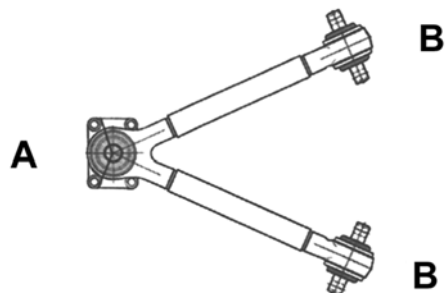
TESTE STERZO - TIE RODS END

RIF. OCAP OCAP REF.	RIF. ORIG O.E. NUMBER	NOTE REMARKS	MODELLO / DESCRIZIONE MODEL / DESCRIPTION
0188994 	81953016286	L=140 M=30x1,5 RHT	TGA - TGS - TGX
0287360 	82953016016 81953016337 81953016281	L=90 M=26x1,5 RHT	TGA - TGS - TGX
0287361 	81953016280	L=75 M=26x1,5 RHT	TGA - TGS - TGX
0289923 	81953016268 81953016018 81953016019	L=90 M=36X1,5 RHT	TGA - TGS

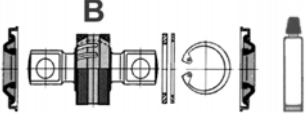

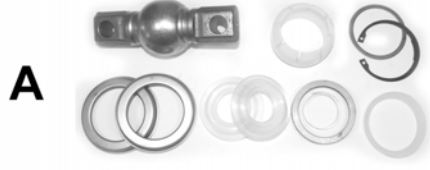
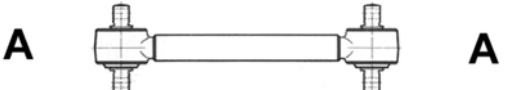



BARRE DI REAZIONE - TORQUE RODS

RIF. OCAP OCAP REF.	RIF. ORIG O.E. NUMBER	NOTE REMARKS	MODELLO / DESCRIZIONE MODEL / DESCRIPTION
<p>0807407</p> 	<p>81432206382 81432206272 81432206305 81432209267 81432206267 81432206401 81432206236 81432209236 81432206304 81432209272 81432206380 81432206229</p>	<p>L=572 T=48 l=130 d=19</p>	<p>TGA - TGS - TGX</p>
<p>0907407</p> 	<p>85.43220.6002 85432206002</p>	<p>l=130 D=74,9 d=19</p>	
<p>0807559</p> 	<p>81432206129</p>	<p>L=571 d=19</p>	<p>F 2000 M 2000 TGA</p>
<p>0907258</p> 	<p>81432206108 81432206132</p>	<p>l=130 p=30 D=65 d=19</p>	
<p>0907757</p> 	<p>81432206108</p>	<p>D=65</p>	
<p>0807533</p> 	<p>81432706078 81432706076 81432706074 81432706034 81432706054 81432706082</p>	<p>L=621 d=23</p>	<p>TGA</p>





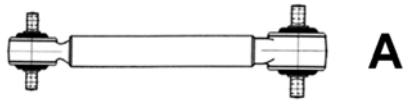
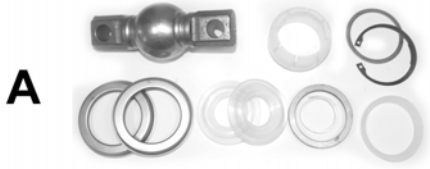

BARRE DI REAZIONE - TORQUE RODS

RIF. OCAP OCAP REF.	RIF. ORIG O.E. NUMBER	NOTE REMARKS	MODELLO / DESCRIZIONE MODEL / DESCRIPTION
<p>0907533</p> 	<p>81953016132 03304800A 0005861035</p>	<p>L=61 IK=46 D=80</p>	
<p>0907534</p> 	<p>81953016133</p>	<p>l=152 p=35 D=80 d=23</p>	
<p>0807807</p> 	<p>81432206174</p>	<p>L=644 T=50</p>	M2000
<p>0907258</p> 	<p>81432206108 81432206132</p>	<p>l=130 p=30 D=65 d=19</p>	
<p>0807811</p> 	<p>81432206067 81432206092 81432209092 81432206120 81432206090</p>	<p>L=590 d=19</p>	TGA
<p>0907259</p> 	<p>81432206055 81432206073 81432206107 81432206250 81953020041</p>	<p>l=130 p=30 D=70 d=19</p>	
<p>0807817</p> 	<p>81432206260 81432206283</p>	<p>L=941 T=48 l=115 d=17</p>	TGA - TGS - TGX
<p>0907528</p> 	<p>81432306051 81432306068 81432706064 81432206244</p>	<p>l=115 p=24 D=75 d=17</p>	



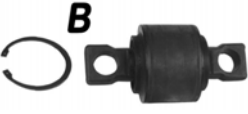



BARRE DI REAZIONE - TORQUE RODS

RIF. OCAP OCAP REF.	RIF. ORIG O.E. NUMBER	NOTE REMARKS	MODELLO / DESCRIZIONE MODEL / DESCRIPTION
<p>0807820</p>  <p>A</p> <p>0907820</p>  <p>A</p>	<p>81432206247 81432206341 81432206342</p> <p>81432206322</p>	<p>L=414 T=50 l=130 d=23</p> <p>l=130 p=30 D=72 d=23</p>	TGA - TGS - TGX
<p>0807821</p>  <p>A</p> <p>0907259</p>  <p>A</p>	<p>81432206161 81432206190</p> <p>81432206055 81432206073 81432206107 81432206250 81953020041</p>	<p>L=531 T=50 l=130 d=19</p> <p>l=130 p=30 D=70 d=19</p>	TGA
<p>0807824</p>  <p>A</p> <p>0907258</p>  <p>A</p> <p>0907757</p>  <p>A</p>	<p>81432206140 81432209140</p> <p>81432206108 81432206132</p> <p>81432206108</p>	<p>L=596 d2=18,5 d1=19</p> <p>l=130 p=30 D=65 d=19</p> <p>D=65</p>	M2000 senza perno (without pin)

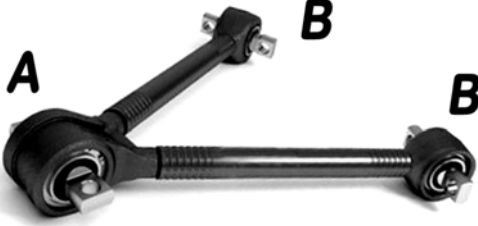

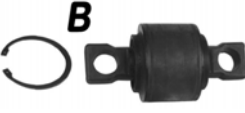



BARRE DI REAZIONE - TORQUE RODS

RIF. OCAP OCAP REF.	RIF. ORIG O.E. NUMBER	NOTE REMARKS	MODELLO / DESCRIZIONE MODEL / DESCRIPTION
<p>0807839</p>  <p>0907774</p>  <p>0907907</p> 	<p>81432706087 81432706088 81432706094 81432706095 81432706137 81432706150</p> <p>81432706110</p> <p>81432706105 81432706124</p>	<p>L=627 T=48</p> <p>I=152 p=24 D1=100 d=25</p> <p>I=130 p=24,3 d=25</p>	<p>TGA - TGS - TGX</p>
<p>0807840</p>  <p>0907533</p>  <p>0907840</p> 	<p>81432706096 81432206221 81432706114 81432706121</p> <p>81953016132 03304800A 0005861035</p> <p>81432706123 81432706126 81432706118</p>	<p>L=627 T=48</p> <p>L=61 IK=46 D=80</p> <p>I=130 p=30 D=85 d=23</p>	<p>TGA - TGS - TGX</p>

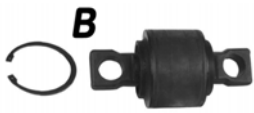

BARRE DI REAZIONE - TORQUE RODS

RIF. OCAP OCAP REF.	RIF. ORIG O.E. NUMBER	NOTE REMARKS	MODELLO / DESCRIZIONE MODEL / DESCRIPTION
<p>0807841</p> 	<p>81432706137 81432706116 81432706150 81432706151</p>	<p>L=627 T=48</p>	<p>F2000 TGA - TGS - TGX</p>
<p>0907774</p> 	<p>81432706110</p>	<p>l=152 p=24 D1=100 d=25</p>	
<p>0907907</p> 	<p>81432706105 81432706124</p>	<p>l=130 p=24,3 d=25</p>	
<p>0807842</p> 	<p>81432706097 81432706113 81432706135 81432706160 81432706161</p>	<p>L=627 T=46</p>	<p>TGA- TGS - TGX</p>
<p>0807894</p> 	<p>81432206268 81432206236 81432206267 81432206272 81432206229 81432209236 81432206401 81432209272 81432206380 81432209297 81432206305 81432206270 81432206304 81432206382</p>	<p>L=572 T=52</p>	<p>TGA - TGS - TGX</p>
<p>0907407</p> 	<p>85.43220.6002 85432206002</p>	<p>l=130 D=74,9 d=19</p>	







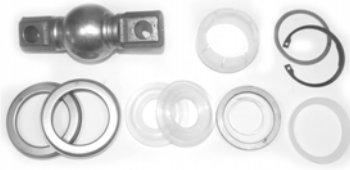

BARRE DI REAZIONE - TORQUE RODS

RIF. OCAP OCAP REF.	RIF. ORIG O.E. NUMBER	NOTE REMARKS	MODELLO / DESCRIZIONE MODEL / DESCRIPTION
<p>0807906</p> 	<p>81432206196 81432206232 81432206233</p>	<p>L=596 T=48 d=19</p>	TGA - TGS - TGX
<p>0807907</p> 	<p>81432706117 81432706152</p>	<p>L=627 T=58 d=19</p>	TGA - TGS - TGX
<p>0907533</p> 	<p>81953016132 03304800A 0005861035</p>	<p>L=61 IK=46 D=80</p>	
<p>0907907</p> 	<p>81432706105 81432706124</p>	<p>l=130 p=24,3 d=25</p>	
<p>0809420</p> 	<p>81432206327 81432206271 81432206282 81432206314</p>	<p>L=572</p>	TGA - TGS - TGX
<p>0909992</p> 	<p>81432206285</p>	<p>l=130 p=24 D=85 d=25</p>	
<p>0809446</p> 	<p>81432206270</p>	<p>L=572 l=130 d=19</p>	TGA - TGS - TGX







BARRE DI REAZIONE - TORQUE RODS

RIF. OCAP OCAP REF.	RIF. ORIG O.E. NUMBER	NOTE REMARKS	MODELLO / DESCRIZIONE MODEL / DESCRIPTION
<p>0907407</p> 	<p>85.43220.6002 85432206002</p>	<p>l=130 D=74,9 d=19</p>	
<p>0809988</p> 	<p>81432706145 82432706005 81432706147 81432701601 81432706146 82432706007</p>	<p>L=622 T=60 l=130 d=24</p>	<p>TGA - TGS - TGX</p>

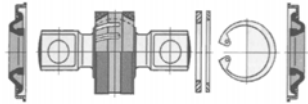
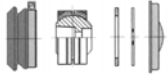

KIT DI SOSPENSIONE - SUSPENSION KITS

RIF. OCAP OCAP REF.	RIF. ORIG O.E. NUMBER	NOTE REMARKS	MODELLO / DESCRIZIONE MODEL / DESCRIPTION
0907258 	81432206108 81432206132	l=130 p=30 D=65 d=19	L2000 M2000 TGA - TGS - TGX
0907259 	81432206055 81432206073 81432206107 81432206250 81953020041	l=130 p=30 D=70 d=19	L2000 M2000 TGA - TGS - TGX
0907327 	81432306061 81432706091 85432206002	l=130 p=24 D1=75 d=19	TGA - TGS - TGX
0907407 	85.43220.6002 85432206002	l=130 D=74,9 d=19	TGA - TGS - TGX
0907525 	81432706080		TGA - TGS - TGX
0907528 	81432306051 81432306068 81432706064 81432206244	l=115 p=24 D=75 d=17	M2000 TGA - TGS - TGX
0907529 	81432706079 81432306099		TGA
0907533 	81953016132 03304800A 0005861035	L=61 lK=46 D=80	TGA - TGS - TGX





KIT DI SOSPENSIONE - SUSPENSION KITS

RIF. OCAP OCAP REF.	RIF. ORIG O.E. NUMBER	NOTE REMARKS	MODELLO / DESCRIZIONE MODEL / DESCRIPTION
0907534 	81953016133	l=152 p=35 D=80 d=23	TGA
0907683 	81953016132 81432706080 81432706122	D=80 IK=46	TGA - TGS - TGX
0907757 	81432206108	D=65	M2000 F 2000 M 2000 TGA
0907774 	81432706110	l=152 p=24 D1=100 d=25	TGA - TGS - TGX
0907820 	81432206322	l=130 p=30 D=72 d=23	TGA - TGS - TGX
0907840 	81432706123 81432706126 81432706118	l=130 p=30 D=85 d=23	TGA - TGS - TGX
0907907 	81432706105 81432706124	l=130 p=24,3 d=25	TGA - TGS - TGX
0909992 	81432206285	l=130 p=24 D=85 d=25	TGA - TGS - TGX



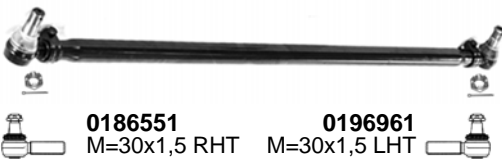

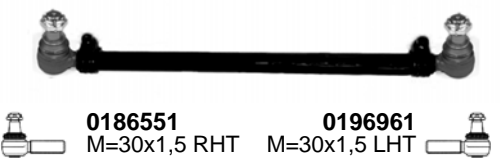
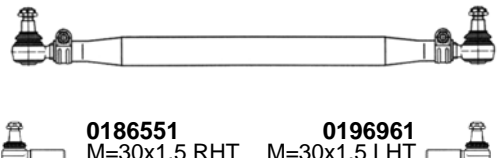
TESTE COMANDO CAMBIO - GEAR BOX CONTROL BALL JOINTS

RIF. OCAP OCAP REF.	RIF. ORIG O.E. NUMBER	NOTE REMARKS	MODELLO / DESCRIZIONE MODEL / DESCRIPTION
0187228 	81953016169	L=85 M=14x1,5 RHT	M 2000
0287229 	81953016170	L=55 M=12x1,75 RHT	L 2000 M 2000 TGL TGM
0297229 	81953016063 81953016131 81953016171 81953016174	L=55 M=12x1,75 LHT	L 2000 M 2000 TGL TGM

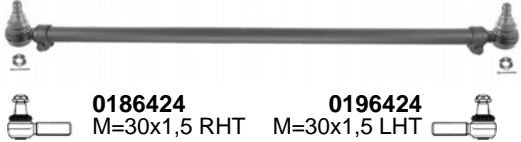
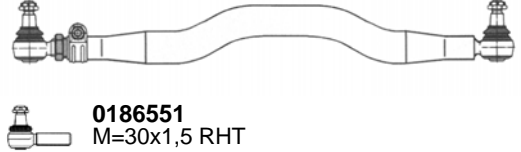

BARRE ACCOPPIAMENTO - TIE RODS

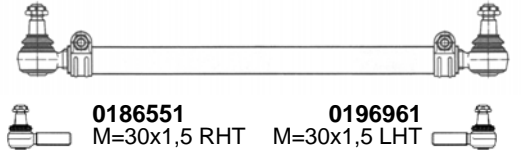
RIF. OCAP OCAP REF.	RIF. ORIG O.E. NUMBER	NOTE REMARKS	MODELLO / DESCRIZIONE MODEL / DESCRIPTION
<p>0507436</p>  <p>0186551 0196961 M=30x1,5 RHT M=30x1,5 LHT</p>	<p>9493301003 9493301103 9493301703</p>	<p>L=1596 T=50</p>	<p>ACTROS - ACTROS MP2-MP3 AXOR 2</p>
<p>0507437</p>  <p>0186598 M=30x1,5 RHT</p>	<p>9443301703 6253303203</p>	<p>L=1588 T=58</p>	<p>ACTROS - ACTROS MP2 - MP3 ATEGO AXOR 2</p>
<p>0507587</p>  <p>0186551 0196961 M=30x1,5 RHT M=30x1,5 LHT</p>	<p>0014601505 0014607305 0034603305 3754601605</p>	<p>L=733 T=36</p>	<p>ACTROS - ACTROS MP2 - MP3 AXOR 2</p>
<p>0507591</p>  <p>0186551 0196961 M=30x1,5 RHT M=30x1,5 LHT</p>	<p>9493300203 9493300303 9493300903 9493300803</p>	<p>L=1615 T=50</p>	<p>ACTROS - ACTROS MP2 - MP3 ATEGO AXOR 2</p>
<p>0507603</p>  <p>0186551 M=30x1,5 RHT</p>	<p>9493300603 9493300703 9493301503 9493301603 9493302003 9493302403</p>	<p>L=1687 T=52</p>	<p>ACTROS - ACTROS MP2 - MP3 ATEGO AXOR - AXOR 2</p>
<p>0507604</p>  <p>0186551 M=30x1,5 RHT</p>	<p>9493300403 9493300503 9493300803 9493301403 9493301903 9493302303</p>	<p>L=1700 T=52</p>	<p>ACTROS - ACTROS MP2 - MP3 ATEGO AXOR 2</p>





BARRE ACCOPPIAMENTO - TIE RODS

RIF. OCAP OCAP REF.	RIF. ORIG O.E. NUMBER	NOTE REMARKS	MODELLO / DESCRIZIONE MODEL / DESCRIPTION
<p>0507610</p>  <p>0186424 M=30x1,5 RHT 0196424 M=30x1,5 LHT</p>	<p>3913300603 3913300803 3913301003 3913301203</p>	<p>L=1190 T=40</p>	<p>MK - NG - SK</p>
<p>0507633</p>  <p>0186551 M=30x1,5 RHT</p>	<p>9423300203 9423300103 9423300003 9423301103</p>	<p>L=1735 T=52</p>	<p>ACTROS - ACTROS MP2 - MP3 ATEGO AXOR2 ECONIC</p>
<p>0507643</p>  <p>0186551 M=30x1,5 RHT 0196961 M=30x1,5 LHT</p>	<p>9413300503 9413300203 9413300003 9413300103 9413300303</p>	<p>L=1735 T=50</p>	<p>ACTROS - ACTROS MP2 - MP3 ATEGO AXOR 2</p>
<p>0507651</p>  <p>0186551 M=30x1,5 RHT 0196961 M=30x1,5 LHT</p>	<p>9453300503 9453300203 9453300303</p>	<p>L=1465 T=40</p>	<p>ACTROS - ACTROS MP2 - MP3 ATEGO ECONIC</p>
<p>0507916</p>  <p>0187916 M30x1,5 RHT</p>	<p>9453300003 9453300103 9453300403 9453300603</p>	<p>L=1735 T=62</p>	<p>ACTROS - ACTROS MP2 - MP3 ATEGO ECONIC</p>
<p>0507975</p>  <p>0186598 M=30x1,5 RHT 0196598 M=30x1,5 LHT</p>	<p>9753302503 9753300803 9753300303 9753300203 9753302503</p>	<p>L=1607 T=40</p>	<p>ATEGO - ATEGO 2 - 3</p>



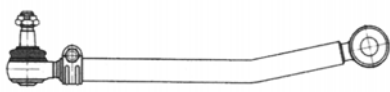
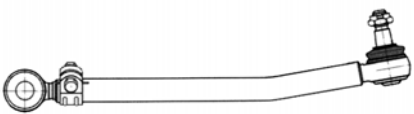

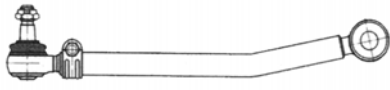

BARRE ACCOPPIAMENTO - TIE RODS

RIF. OCAP OCAP REF.	RIF. ORIG O.E. NUMBER	NOTE REMARKS	MODELLO / DESCRIZIONE MODEL / DESCRIPTION
<p>0508967</p>  <p>0186551 0196961 M=30x1,5 RHT M=30x1,5 LHT</p>	<p>6253300603 9423300903 9423300503 6253302003 6253302703 9423301903</p>	<p>L=1565 T=50</p>	<p>ACTROS ATEGO AXOR 2</p>
<p>0509391</p>  <p>0186424 0196424 M=30x1,5 RHT M=30x1,5 LHT</p>	<p>9703300003</p>	<p>L=1640 T=40</p>	<p>ATEGO - ATEGO 2 - 3</p>
<p>0509442</p> 	<p>9603300403</p>	<p>L=1685 T=52</p>	<p>ACTROS MP4-MP5 ECONIC</p>







TIRANTI LONGITUDINALI - DRAG LINKS

RIF. OCAP OCAP REF.	RIF. ORIG O.E. NUMBER	NOTE REMARKS	MODELLO / DESCRIZIONE MODEL / DESCRIPTION
<p>0506576</p>  <p>0187146 M=30x1,5 RHT</p>	6754602205	L=780 T=40	LK - LN2 (-98)
<p>0506577</p>  <p>0187146 M=30x1,5 RHT</p>	6764601105	L=780 T=40	LK - LN2 (-98)
<p>0506578</p>  <p>0186598 M=30x1,5 RHT</p>	6194605205 6194602505 6194602905	L=860 T=42	MK - NG - SK
<p>0506581</p>  <p>0187146 M=30x1,5 RHT</p>	6754602405 6754601205 6754601805 6754603005	L=727 T=40	LK/LN2
<p>0506583</p>  <p>0186547 M=30x1,5 RHT</p>	6734600605	L=725 T=36	LK - LN2 (-98)
<p>0506585</p>  <p>0186598 M=30x1,5 RHT</p>	0004607105 0004607205 0014606705	L=879 T=42	ACTROS AXOR - AXOR 2



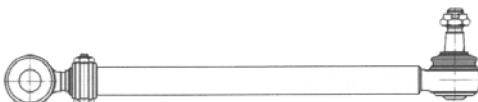

TIRANTI LONGITUDINALI - DRAG LINKS

RIF. OCAP OCAP REF.	RIF. ORIG O.E. NUMBER	NOTE REMARKS	MODELLO / DESCRIZIONE MODEL / DESCRIPTION
<p>0506962</p>  <p>0186598 M=30x1,5 RHT</p>	<p>6474600005 3874600705 6474600105 3874603305 3874601405 3874603205</p>	<p>L=865 T=40</p>	<p>MK - NG</p>
<p>0507439</p>  <p>0186424 M=30x1,5 RHT</p>	<p>9724601405 9724601605</p>	<p>L=837 T=40</p>	<p>ATEGO - ATEGO 2</p>
<p>0507611</p>  <p>0186424 M=30x1,5 RHT</p>	<p>4244600305 4274600005 4274600105 4274600305 4274600405</p>	<p>L=877 T=38</p>	<p>UNIMOG</p>
<p>0507613</p>  <p>0186424 M=30x1,5 RHT</p>	<p>9704600905 9704600705</p>	<p>L=846 T=42</p>	<p>ATEGO - ATEGO 2</p>
<p>0507614</p>  <p>0187959 M=30x1,5 RHT</p>	<p>0034605705 0024609605 0024609705</p>	<p>L=858 T=40</p>	<p>ACTROS - ACTROS MP2-MP3</p>
<p>0507615</p>  <p>0187959 M=30x1,5 RHT</p>	<p>0024604905 0024605005</p>	<p>L=895 T=40</p>	<p>ATEGO AXOR - AXOR 2</p>



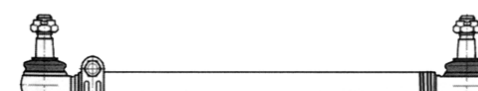







TIRANTI LONGITUDINALI - DRAG LINKS

RIF. OCAP OCAP REF.	RIF. ORIG O.E. NUMBER	NOTE REMARKS	MODELLO / DESCRIZIONE MODEL / DESCRIPTION
<p>0507617</p>  <p>0187959 M=30x1,5 RHT</p>	<p>4054600005 4054600305 4054600605</p>	<p>L=753 T=42</p>	<p>UNIMOG</p>
<p>0507627</p>  <p>0186598 M=30x1,5 RHT</p>	<p>0004609905 0004609805</p>	<p>L=900</p>	<p>SK</p>
<p>0507630</p>  <p>0187789 M=28x1,5 RHT</p>	<p>0024604405 0024604305 0034604805</p>	<p>L=879 T=35</p>	<p>ACTROS - ACTROS MP2 - MP3 ATEGO 2 AXOR - AXOR 2</p>
<p>0507631</p>  <p>0187959 M=30x1,5 RHT</p>	<p>0024604805 0024604705 0034604905</p>	<p>L=876 T=40</p>	<p>ACTROS - ACTROS MP2 - MP3 AXOR AXOR 2 - ATEGO 2</p>
<p>0507632</p>  <p>0186598 M=30x1,5 RHT</p>	<p>0024606405 0014609805 0014609905</p>	<p>L=866 T=38</p>	<p>ACTROS - ACTROS MP2-MP3</p>
<p>0507639</p>  <p>0187146 M=30x1,5 RHT</p>	<p>6764601905 6764602105</p>	<p>L=783 T=42</p>	<p>LK/LN 2</p>







TIRANTI LONGITUDINALI - DRAG LINKS

RIF. OCAP OCAP REF.	RIF. ORIG O.E. NUMBER	NOTE REMARKS	MODELLO / DESCRIZIONE MODEL / DESCRIPTION
<p>0507642</p>  <p>0187959 M=30x1,5 RHT</p>	<p>0034601805 0034601905 0034605805</p>	<p>L=888 T=42</p>	<p>ACTROS MP2 - MP3</p>
<p>0507789</p>  <p>0187789 M=28x1,5 RHT</p>	<p>0024604505 0024604605 3754600405</p>	<p>L=895 T=36</p>	<p>ACTROS - ACTROS MP2 - MP3 ATEGO - ATEGO 2 AXOR 2</p>
<p>0507794</p>  <p>0186424 M=30x1,5 RHT</p>	<p>6764603105</p>	<p>L=783 T=42</p>	<p>LK/LN2</p>
<p>0507827</p>  <p>0186598 M=30x1,5 RHT</p>	<p>9724602005 9724601805 0034605905</p>	<p>L=895 T=50</p>	<p>ATEGO - ATEGO 2</p>
<p>0507887</p>  <p>0186598 M=30x1,5 RHT</p>	<p>0034604605 3754600005 9744601005 9744601205</p>	<p>L=894 T=50</p>	<p>ATEGO - ATEGO 2</p>
<p>0507905</p>  <p>0186613 M=28x1,5 RHT</p>	<p>6674601705 6674601505</p>	<p>L=504 T=34</p>	<p>VARIO</p>

TIRANTI LONGITUDINALI - DRAG LINKS

RIF. OCAP OCAP REF.	RIF. ORIG O.E. NUMBER	NOTE REMARKS	MODELLO / DESCRIZIONE MODEL / DESCRIPTION
0507911 	0014601305 3754601505 0024600505 0014601405 0034603205	L=1095 T=42	ACTROS - ACTROS MP2 - MP3 AXOR 2
0507912   0186551 M=30x1,5 RHT	0024605205	L=885 T=38	ACTROS - ACTROS MP2 - MP3 ATEGO AXOR 2
0507961 	0014601105 0024600405 0034603105	L=711 T=42	ACTROS - ACTROS MP2-MP3
0507962   0186551 M=30x1,5 RHT	0034604205 0024606105 0034606205	L=958 T=38	ACTROS - ACTROS MP2 - MP3 ATEGO AXOR 2
0507963   0186598 M=30x1,5 RHT	0034604705 9744601105 9744601305 0034600705	L=894 T=50	ATEGO - ATEGO 2
0507965   0186551 M=30x1,5 RHT	0034604105 0024605905 0024606005	L=935 T=38	ACTROS - ACTROS MP2 - MP3

TIRANTI LONGITUDINALI - DRAG LINKS

RIF. OCAP OCAP REF.	RIF. ORIG O.E. NUMBER	NOTE REMARKS	MODELLO / DESCRIZIONE MODEL / DESCRIPTION
<p>0507967</p>  <p>0186551 M=30x1,5 RHT</p>	<p>0014607105 0004609505</p>	<p>L=904 T=52</p>	<p>ACTROS - ACTROS MP2 - MP3</p>
<p>0507968</p>  <p>0186598 M=30x1,5 RHT</p>	<p>0014600705 0014600805 0014607005</p>	<p>L=888 T=38</p>	<p>ACTROS</p>
<p>0507972</p>  <p>0186551 M=30x1,5 RHT</p>	<p>9574600505 9574600705</p>	<p>L=860 T=50</p>	<p>ECONIC</p>
<p>0508939</p> 	<p>9574600405 9574600905</p>	<p>L=387 T=36</p>	<p>ECONIC</p>
<p>0508957</p>  <p>0186551 M=30x1,5 RHT</p>	<p>0024608605 0024608705</p>	<p>L=883 T=38</p>	<p>ACTROS - ACTROS MP2 - MP3</p>
<p>0509461</p>  <p>0186551 M=30x1,5 RHT</p>	<p>0024608805 0024608905</p>	<p>L=761 T=38</p>	<p>ACTROS - ACTROS MP2 - MP3 AXOR 2</p>

TIRANTI LONGITUDINALI - DRAG LINKS

RIF. OCAP OCAP REF.	RIF. ORIG O.E. NUMBER	NOTE REMARKS	MODELLO / DESCRIZIONE MODEL / DESCRIPTION
<p>0509470</p>  <p>0187686 M=30x1,5 RHT</p>	<p>0034608605</p>	<p>L=776 T=46</p>	<p>ACTROS MP4-MP5</p>





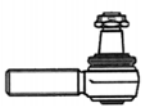

TESTE STERZO - TIE RODS END

RIF. OCAP OCAP REF.	RIF. ORIG O.E. NUMBER	NOTE REMARKS	MODELLO / DESCRIZIONE MODEL / DESCRIPTION
0186424 	0014604448 0023301535 0013300135 0003307335 0013300235 0014603148 0014603448 0014608348 0014608448	L=115 M=30x1,5 RHT	ACTROS ATEGO 2 AXOR UNIMOG
0196424 	0013308835 3023300035 3023300135 3023300335 3023300355 3023300235 0014604348 3503307135 0003406218 0013306635	L=115 M=30x1,5 LHT	ACTROS ATEGO 2 AXOR
0186547 	0013300335	L=115 M=30x1,5 RHT	LK - LN
0196547 	-	L=115 M=30x1,5 LHT	LK - LN
0186551 	0004606848 0014607648 0014601748 0004605748 0004607548 0014600448 0014601148 0014602448 0004607048	L=120 M=30x1,5 RHT	ACTROS - ACTROS MP2 - MP3 ATEGO 2 AXOR
0186598 	0024600148 0004602948 0014601848 0004601048 0004602848 0014602248 0014607748	L=120 M=30x1,5 RHT	ATEGO
0196598 	0014603648 0004603548 0014601448 0004603448 0014602348 0014607848	L=120 M=30x1,5 LHT	ATEGO



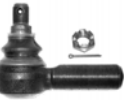



TESTE STERZO - TIE RODS END

RIF. OCAP OCAP REF.	RIF. ORIG O.E. NUMBER	NOTE REMARKS	MODELLO / DESCRIZIONE MODEL / DESCRIPTION
0186612 	0003309735 0003309935 0003383429 0003301235	L=105 M=24x1,5 RHT	VARIO
0196612 	0003301235 0003301335 0003307535 0003307635	L=105 M=24x1,5 LHT	VARIO
0186613 	0003309335 0003301435 0003301535 0003307135 0003309535 0003382129	L=105 M=28x1,5 RHT	VARIO
0186758 	A0003305248 A0003406169 A0003406251	L=135 M=30x1,5 RHT	LK - LN
0187146 	0004602648	L=120 M=30x1,5 RHT	LK - LN - NG
0197146 	0014607448	L=120 M=30x1,5 LHT	LK - LN - NG
0187467 	0004601748	L=135 M=38x1,5 RHT	ACTROS
0197467 	6851490000	L=135 M=38x1,5 LHT	ACTROS

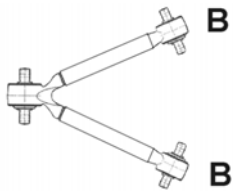

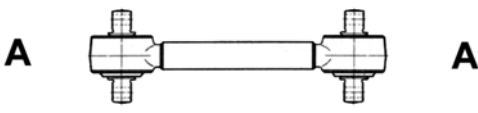

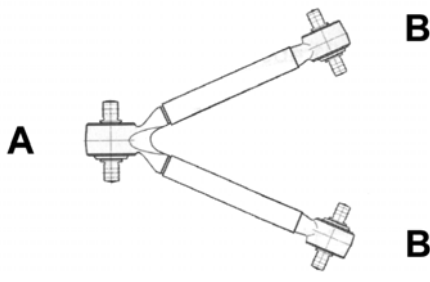

TESTE STERZO - TIE RODS END

RIF. OCAP OCAP REF.	RIF. ORIG O.E. NUMBER	NOTE REMARKS	MODELLO / DESCRIZIONE MODEL / DESCRIPTION
0187789 	0014604148 A0014608948	L=141 M=28X1,5 RHT	ACTROS - ACTROS MP2 - MP3 ATEGO 2 AXOR - AXOR 2
0187916 	0014602948	L=146 M30x1,5 RHT	ACTROS - ACTROS MP2 - MP3 ATEGO ECONIC
0187959 	0014609948 0014605148 0014608648 0014603848 0014604848	L=115 M=30x1,5 RHT	ACTROS - ACTROS MP2-MP3-MP4-MP5 AXOR
0196961 	0004606948 0014607948 0014602548 0014600548 0004606148 0004607148	L=120 M=30x1,5 LHT	ACTROS - ACTROS MP2 - MP3 ATEGO 2 AXOR
0287684 	0004604948	L=95 M=26x1,5 RHT	ACTROS MP 2 - MP 3 ATEGO - ATEGO 2 AXOR 2
0288930 	0014601648 0024600648	L=75 M=26x1,5 RHT	ACTROS MP2 - MP3 AXOR 2



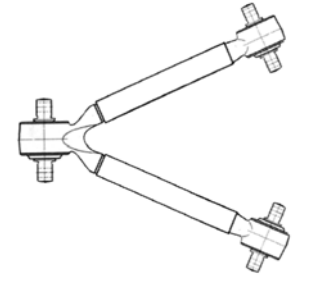

BARRE DI REAZIONE - TORQUE RODS

RIF. OCAP OCAP REF.	RIF. ORIG O.E. NUMBER	NOTE REMARKS	MODELLO / DESCRIZIONE MODEL / DESCRIPTION
<p>0807599</p> 	<p>9423500505 9423501205 9423500805</p>	<p>L=622</p>	<p>ACTROS ACTROS MP2 - MP3 - MP4 - MP5 AXOR 2 ECONIC 2</p>
<p>0907599</p> 	<p>0003502505</p>	<p>l=130 p=24 D1=75 d=25</p>	
<p>0807611</p> 	<p>6593501106 3953500006 6243500006 6593503406</p>	<p>L=579 d=21</p>	<p>NG - SK</p>
<p>0907330</p> 	<p>0003500413 0005861235</p>	<p>l=152 p=24 D=80 d=21</p>	
<p>0807634</p> 	<p>9443500005 9473500105 9443500305 9423501005 9423501505 9473500705 9473501005</p>	<p>L=622 d=25</p>	<p>ACTROS - ACTROS MP2 - MP3 - MP4 - MP5 ATEGO AXOR 2 ECONIC</p>
<p>0907634</p> 	<p>0003504405 0003504005 0003502305</p>	<p>l=152 p=24 D1=85 d=25</p>	
<p>0907599</p> 	<p>0003502505</p>	<p>l=130 p=24 D1=75 d=25</p>	





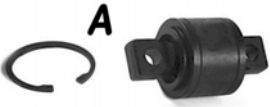
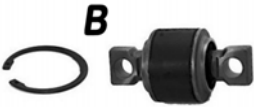

BARRE DI REAZIONE - TORQUE RODS

RIF. OCAP OCAP REF.	RIF. ORIG O.E. NUMBER	NOTE REMARKS	MODELLO / DESCRIZIONE MODEL / DESCRIPTION
<p>0807635</p>  <p>A A</p>	<p>9453300007</p>	<p>L=850</p> <p>d=17</p>	<p>ACTROS - ACTROS MP2 - MP3 ATEGO - ATEGO 2</p>
<p>0907635</p>  <p>A</p>	<p>0003301411</p>	<p>I=100 p=20 D1=67 d=17</p>	
<p>0807636</p>  <p>A A</p>	<p>9413300007</p>	<p>L=845</p> <p>d=17</p>	<p>ACTROS - ACTROS MP2 - MP3 ATEGO AXOR 2 ECONIC</p>
<p>0907635</p>  <p>A</p>	<p>0003301411</p>	<p>I=100 p=20 D1=67 d=17</p>	
<p>0807669</p>  <p>A A</p>	<p>9483501205 9483501305 9483500805 9473500005 9473500605 9483500006 8483500106 9483502005 9483502405</p>	<p>L=565 T=52</p> <p>d=21</p>	<p>ACTROS - ACTROS MP2 - MP3 ATEGO AXOR - AXOR 2</p>
<p>0907547</p>  <p>A</p>	<p>0003502705</p>	<p>I=152</p> <p>D=70 d=21</p>	
<p>0807774</p>  <p>A B B</p>	<p>9483500405 9483503005 9443500505 9473500905</p>	<p>L=622</p> <p>d=25</p>	<p>ACTROS - ACTROS MP2 - MP3 AXOR - AXOR 2</p>

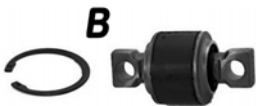

BARRE DI REAZIONE - TORQUE RODS

RIF. OCAP OCAP REF.	RIF. ORIG O.E. NUMBER	NOTE REMARKS	MODELLO / DESCRIZIONE MODEL / DESCRIPTION
<p>0907774</p>  <p>A</p>	<p>0003502405 0003504905</p>	<p>I=152 p=24 D1=100 d=25</p>	
<p>0907599</p>  <p>B</p>	<p>0003502505</p>	<p>I=130 p=24 D1=75 d=25</p>	
<p>0807908</p>  <p>A B</p>	<p>9483502205 9483501705</p>	<p>L=621,5 T=60</p>	<p>ACTROS - ACTROS MP2 - MP3 AXOR 2</p>
<p>0907908</p>  <p>A</p>	<p>0003503605</p>	<p>I=152 p=30 d=25</p>	
<p>0907909</p>  <p>B</p>	<p>0003503705</p>	<p>I=130 p=30 d=23</p>	
<p>0808975</p>  <p>A A</p>	<p>9453500105 9483501005 9483502505</p>	<p>L=615 T=52</p>	<p>ACTROS MP2 - MP3 AXOR 2</p>
<p>0907547</p>  <p>A</p>	<p>0003502705</p>	<p>I=152 D=70 d=21</p>	





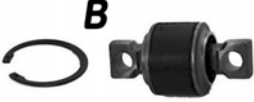



BARRE DI REAZIONE - TORQUE RODS

RIF. OCAP OCAP REF.	RIF. ORIG O.E. NUMBER	NOTE REMARKS	MODELLO / DESCRIZIONE MODEL / DESCRIPTION
<p>0808982</p> 	<p>9483502905</p>	<p>L=622 T=46</p>	<p>ACTROS MP2 - MP3 AXOR 2</p>
<p>0907774</p> 	<p>0003502405 0003504905</p>	<p>l=152 p=24 D1=100 d=25</p>	
<p>0907609</p> 	<p>0003502205 0003504505 0003503205 0003502505</p>	<p>l=130 p=24 D=62 d=25</p>	
<p>0808986</p> 	<p>9483500905 9483502305</p>	<p>L=667 T=60</p>	<p>ACTROS - ACTROS MP2 - MP3 AXOR 2</p>
<p>0907908</p> 	<p>0003503605</p>	<p>l=152 p=30 d=25</p>	
<p>0907909</p> 	<p>0003503705</p>	<p>l=130 p=30 d=23</p>	
<p>0808987</p> 	<p>9743500005 9743500405 9743500505</p>	<p>L=761,70 T=46</p>	<p>ATEGO - ATEGO 2 - ATEGO 3</p>





BARRE DI REAZIONE - TORQUE RODS

RIF. OCAP OCAP REF.	RIF. ORIG O.E. NUMBER	NOTE REMARKS	MODELLO / DESCRIZIONE MODEL / DESCRIPTION
<p>0907622</p>  <p>A</p> <p>0907909</p>  <p>B</p>	<p>0003502105 0003504605</p> <p>0003503705</p>	<p>l=152 p=24 D1=75 d=25</p> <p>l=130 p=30 d=23</p>	
<p>0809444</p> 	<p>9603500906</p>	<p>L=532 T=46 l=130 d=21</p>	<p>ACTROS MP4 - MP5</p>



KIT DI SOSPENSIONE - SUSPENSION KITS

RIF. OCAP OCAP REF.	RIF. ORIG O.E. NUMBER	NOTE REMARKS	MODELLO / DESCRIZIONE MODEL / DESCRIPTION
0907547 	0003502705	l=152 D=70 d=21	ACTROS - ACTROS MP2 - MP3 - ATEGO AXOR - AXOR 2
0907330 	0003500413 0005861235	l=152 p=24 D=80 d=21	NG - SK
0907599 	0003502505	l=130 p=24 D1=75 d=25	ACTROS ACTROS MP2 - MP3 - MP4 - MP5 AXOR 2 ECONIC 2
0907609 	0003502205 0003504505 0003503205 0003502505	l=130 p=24 D=62 d=25	ACTROS MP2 - MP3 AXOR 2
0907622 	0003502105 0003504605	l=152 p=24 D1=75 d=25	ATEGO - ATEGO 2 - ATEGO 3
0907908 	0003503605	l=152 p=30 d=25	ATEGO - ATEGO 2 - ATEGO 3
0907634 	0003504405 0003504005 0003502305	l=152 p=24 D1=85 d=25	ACTROS ACTROS MP2 - MP3 - MP4 - MP5 ATEGO AXOR 2 ECONIC
0907635 	0003301411	l=100 p=20 D1=67 d=17	ACTROS - ACTROS MP2 - MP3 ATEGO AXOR 2 ECONIC
0907774 	0003502405 0003504905	l=152 p=24 D1=100 d=25	ACTROS - ACTROS MP2 - MP3 AXOR - AXOR 2

KIT DI SOSPENSIONE - SUSPENSION KITS

RIF. OCAP OCAP REF.	RIF. ORIG O.E. NUMBER	NOTE REMARKS	MODELLO / DESCRIZIONE MODEL / DESCRIPTION
0907908 	0003503605	l=152 p=30 d=25	ACTROS - ACTROS MP2 - MP3 AXOR 2
0907909 	0003503705	l=130 p=30 d=23	ACTROS - ACTROS MP2 - MP3 AXOR 2
0907984 	0003502005 0003504705	l=130 p=23 D1=67 d=23	ACTROS - ACTROS MP2 - MP3 ATEGO - ATEGO 2 AXOR 2
0908991 	0003503105 0003502305 0003504405	l=152 p=24 D1=85 d=25	ACTROS - ATEGO 2 AXOR



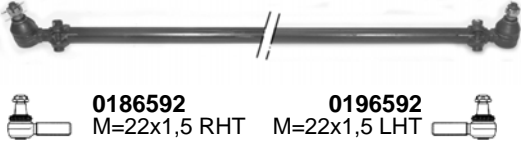

STABILIZZATORI - STABILIZERS

RIF. OCAP OCAP REF.	RIF. ORIG O.E. NUMBER	NOTE REMARKS	MODELLO / DESCRIZIONE MODEL / DESCRIPTION
0508968 	0003220323 0003220623 3753220423	L=1815 T=58	ACTROS - ACTROS MP2-MP3 AXOR 2
0508969 	0003220423 0003220723	L=1815 T=60	ACTROS - ACTROS MP2-MP3



BARRE ACCOPPIAMENTO - TIE RODS

RIF. OCAP OCAP REF.	RIF. ORIG O.E. NUMBER	NOTE REMARKS	MODELLO / DESCRIZIONE MODEL / DESCRIPTION
<p>0506588</p>  <p>0186592 0196592 M=22x1,5 RHT M=22x1,5 LHT</p>	<p>11200265-0</p>	<p>L=1385 T=28</p>	<p>ECO-T</p>





TIRANTI LONGITUDINALI - DRAG LINKS

RIF. OCAP OCAP REF.	RIF. ORIG O.E. NUMBER	NOTE REMARKS	MODELLO / DESCRIZIONE MODEL / DESCRIPTION
<p>0506590</p> 	<p>11200454-0 112004540 485109X101 485109X100 48510D8600 48510LA20A</p>	<p>L=780 T=36</p>	<p>ATLEON</p>
<p>0506591</p>  <p> 0186592 M=22x1,5 RHT</p>	<p>11505036-0</p>	<p>L=755 T=36</p>	<p>ECO-T TRADE</p>
<p>0509411</p>  <p> 0186592 M=22x1,5 RHT</p>	<p>48510-F3900 48510-F3901 48510-LA21D 48510F3900 48510F3901 48510LA21D</p>	<p>L=640 T=36</p>	<p>CABSTAR</p>



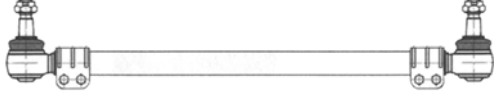
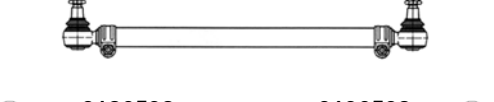

TESTE STERZO - TIE RODS END

RIF. OCAP OCAP REF.	RIF. ORIG O.E. NUMBER	NOTE REMARKS	MODELLO / DESCRIZIONE MODEL / DESCRIPTION
0186592 	11200360-0 11200360-0A 11200360-0B 485279X62A 485139X200	L=95 M=22x1,5 RHT	ATLEON CABSTAR ECO-T TRADE
0196592 	11200361-0 11200361-0A 11200361-0B 486479X62A 485139X201	L=95 M=22x1,5 LHT	ATLEON CABSTAR ECO-T

BARRE ACCOPPIAMENTO - TIE RODS

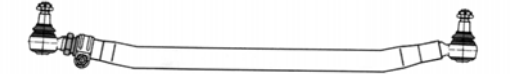
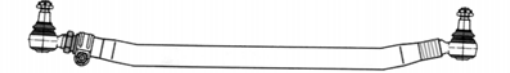
RIF. OCAP OCAP REF.	RIF. ORIG O.E. NUMBER	NOTE REMARKS	MODELLO / DESCRIZIONE MODEL / DESCRIPTION
<p>0506695</p>  <p>0186598 0196598 M=30x1,5 RHT M=30x1,5 LHT</p>	<p>5000786902 5010145077</p>	<p>L=1690 T=48</p>	<p>MIDLINER MIDLUM</p>
<p>0506697</p>  <p>0186424 0196424 M=30x1,5 RHT M=30x1,5 LHT</p>	<p>5000613837</p>	<p>L=1510 T=40</p>	<p>MIDLINER</p>
<p>0506699</p>  <p>0186595 0196595 M=24x1,5 RHT M=24x1,5 LHT</p>	<p>5000446681</p>	<p>L=1415 T=30</p>	<p>MIDLINER</p>
<p>0506939</p>  <p>0186598 0196598 M=30x1,5 RHT M=30x1,5 LHT</p>	<p>5000613598</p>	<p>L=1736 T=40</p>	<p>MIDLUM</p>
<p>0507849</p>  <p>0186598 0196598 M=30x1,5 RHT M=30x1,5 LHT</p>	<p>5010439631 5010098467 5010145584</p>	<p>L=1752 T=48</p>	<p>KERAX PREMIUM</p>
<p>0507855</p>  <p>0186598 0196598 M=30x1,5 RHT M= 30x1,5 LHT</p>	<p>5010566059</p>	<p>L=1720 T=48</p>	<p>PREMIUM KERAX</p>







BARRE ACCOPPIAMENTO - TIE RODS

RIF. OCAP OCAP REF.	RIF. ORIG O.E. NUMBER	NOTE REMARKS	MODELLO / DESCRIZIONE MODEL / DESCRIPTION
<p>0507856</p>  <p>0187723 M=30x1,5 RHT</p>	<p>5010566064 5010439022</p>	<p>L=1720 T=52</p>	<p>PREMIUM</p>
<p>0507858</p>  <p>0187723 M=30x1,5 RHT</p>	<p>5010566063 5010439021</p>	<p>L=1758 T=52</p>	<p>MAGNUM PREMIUM</p>
<p>0507865</p>  <p>0187723 M=30x1,5 RHT</p>	<p>5010439023 5010291903 5010566062</p>	<p>L=1560 T=52</p>	<p>MIDLINER</p>
<p>0508736</p>  <p>0187723 M=30x1,5 RHT</p>	<p>5001868363 7421560957 5010587004 5010600822</p>	<p>L=1655 T=60</p>	<p>PREMIUM 2 MAGNUM</p>
<p>0509435</p>  <p>0188994 M=30x1,5 RHT</p>	<p>5010630434</p>	<p>L=1818 T=58</p>	<p>MAGNUM - PREMIUM 2</p>
<p>0509440</p>  <p>0187723 M=30x1,5 RHT</p>	<p>7422163636</p>	<p>L=1766 T=60</p>	<p>MAGNUM</p>

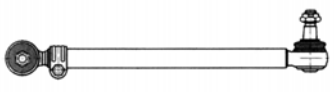



BARRE ACCOPPIAMENTO - TIE RODS

RIF. OCAP OCAP REF.	RIF. ORIG O.E. NUMBER	NOTE REMARKS	MODELLO / DESCRIZIONE MODEL / DESCRIPTION
<p>0509468</p> 	<p>7422159764</p>	<p>L=1671 T=60</p>	<p>SERIE T</p>
<p>0509473</p> 	<p>7422159755 7421192770</p>	<p>L=1693 T=60</p>	<p>SERIE T</p>
<p>0509911</p>  <p>0187723 M=30x1,5 RHT</p>	<p>5001868366</p>	<p>L=1686 T=60</p>	<p>PREMIUM 2 SERIE C</p>
<p>0509914</p> 	<p>7420581086</p>	<p>L=1669 T=42</p>	<p>SERIE C - SERIE K - SERIE T</p>



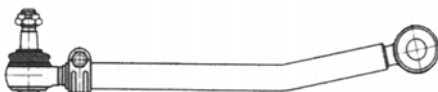







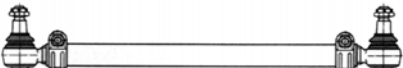

TIRANTI LONGITUDINALI - DRAG LINKS

RIF. OCAP OCAP REF.	RIF. ORIG O.E. NUMBER	NOTE REMARKS	MODELLO / DESCRIZIONE MODEL / DESCRIPTION
<p>0506679</p>  <p>0186598 M=30x1,5 RHT</p>	<p>5010060764 5010557243</p>	<p>L=720 T=36</p>	<p>MAGNUM</p>
<p>0506681</p>  <p>0186598 M=30x1,5 RHT</p>	<p>5010294287</p>	<p>L=810 T=50</p>	<p>PREMIUM</p>
<p>0506682</p>  <p>0186598 M=30x1,5 RHT</p>	<p>5010294502</p>	<p>L=847 T=52</p>	<p>PREMIUM</p>
<p>0506683</p>  <p>0186424 M=30x1,5 RHT</p>	<p>5010130393 7485114936</p>	<p>L=872 T=40</p>	<p>MIDLINER</p>
<p>0506684</p>  <p>0186598 M=30x1,5 RHT</p>	<p>5010294288</p>	<p>L=825 T=52</p>	<p>PREMIUM</p>
<p>0506685</p>  <p>0186598 M=30x1,5 RHT</p>	<p>5010294289 5010630617</p>	<p>L=861 T=62</p>	<p>PREMIUM</p>







TIRANTI LONGITUDINALI - DRAG LINKS

RIF. OCAP OCAP REF.	RIF. ORIG O.E. NUMBER	NOTE REMARKS	MODELLO / DESCRIZIONE MODEL / DESCRIPTION
<p>0506686</p>  <p>0186613 M=28x1,5 RHT</p>	5010037418	L=902 T=40	MIDLINER
<p>0506687</p>  <p>0186598 M=30x1,5 RHT</p>	5010229242	L=934 T=52	KERAX
<p>0506688</p>  <p>0186598 M=30x1,5 RHT</p>	5010130344	L=737 T=52	MAGNUM
<p>0506690</p>  <p>0186424 M=30x1,5 RHT</p>	5000541230 5000352082	L=880 T=40	MIDLINER
<p>0507854</p>  <p>0186598 M=30x1,5 RHT</p>	5010294720	L=827 T=52	PREMIUM
<p>0507861</p>  <p>0182344 M=28x1,5 RHT</p>	5010488164 5010294707	L=886 T=42	MIDLUM





TIRANTI LONGITUDINALI - DRAG LINKS

RIF. OCAP OCAP REF.	RIF. ORIG O.E. NUMBER	NOTE REMARKS	MODELLO / DESCRIZIONE MODEL / DESCRIPTION
0507863   0186424 M=30x1,5 RHT	5010488167 5010305367	L=946 T=42	MIDLUM
0507864   0182345 M=30x1,5 RHT 0192345 M=30x1,5 LHT 	7422482969 5010395796 5010566049	L=1500 T=38	MIDLUM
0507884   0187884 M=24x1,5 RHT 0197884 M=24x1,5 LHT 	5010488464	L=540 T=30	MASCOTT
0507988 	5010488097 5010383529	L=944 T=52	KERAX
0508721 	5001868374 5010630637 5010630638 7421560825	L=700 T=50	MAGNUM
0508722   0186598 M=30x1,5 RHT	5010383203 5010488836 5010557523	L=735 T=50	MAGNUM
0508723 	5010630822 5001868384 5010630823 7421560882	L=825 T=62	PREMIUM 2 SERIE C



TIRANTI LONGITUDINALI - DRAG LINKS

RIF. OCAP OCAP REF.	RIF. ORIG O.E. NUMBER	NOTE REMARKS	MODELLO / DESCRIZIONE MODEL / DESCRIPTION
<p>0508728</p>  <p>0186598 M=30x1,5 RHT</p>	<p>5000453600 5010130394 7485114922</p>	<p>L=902 T=50</p>	<p>MIDLINER</p>
<p>0508998</p> 	<p>5010630980 7421021395 7482292079</p>	<p>L=552 T=60</p>	<p>PREMIUM 2 - KERAX</p>
<p>0509412</p> 	<p>5001868383 7421560865 5010630821 5010630820 7422163226</p>	<p>L=830 T=62</p>	<p>PREMIUM 2 SERIE C</p>
<p>0509439</p>  <p>0186598 M=30x1,5 RHT</p>	<p>5010557341 5010488759 5010488639 5010488084 20818854</p>	<p>L=900 T=50</p>	<p>MIDLUM</p>
<p>0509460</p> 	<p>5001868385 5010630812 5010630813 7421560892</p>	<p>L=833 T=62</p>	<p>SERIE C,D PREMIUM 2</p>
<p>0509462</p> 	<p>7422526504 7421698607</p>	<p>L=900 T=52</p>	<p>SERIE C,K,T</p>
<p>0509463</p>  <p>0186424 M=30x1,5 RHT</p>	<p>5010630255 5010305365</p>	<p>L=909 T=50</p>	<p>MIDLUM SERIE D</p>

TIRANTI LONGITUDINALI - DRAG LINKS

RIF. OCAP OCAP REF.	RIF. ORIG O.E. NUMBER	NOTE REMARKS	MODELLO / DESCRIZIONE MODEL / DESCRIPTION
<p>0509466</p>  <p>0188994 M=30x1,5 RHT</p>	7422163231	L=825 T=62	SERIE C PREMIUM 2
	7421560848	L=696 T=52	MAGNUM
	7421560838	L=697 T=50	MAGNUM
	7422380814 7421698605	L=895 T=52	SERIE C - K - T





TESTE STERZO - TIE RODS END

RIF. OCAP OCAP REF.	RIF. ORIG O.E. NUMBER	NOTE REMARKS	MODELLO / DESCRIZIONE MODEL / DESCRIPTION
0182344 	-	L=110 M=28x1,5 RHT	MIDLUM
0186424 	5001832582 5001859985 5000295214 5000212483 5000812483 5001831473 5001850549	L=115 M=30x1,5 RHT	MIDLINER MIDLUM MAGNUM
0196424 	5000295215 5001859984 5001852263 5001834533 5001850550	L=115 M=30x1,5 LHT	MIDLINER MIDLUM
0186598 	5000288360 5001836298 5010832582 5000253852 5000590236 5000804824 5000858773 5001858760	L=120 M=30x1,5 RHT	MAGNUM MIDLINER PREMIUM KERAX
0196598 	5000288361 5001836297 5010832583 5000242478 5000823265 5000242486 5000858774 5001832581 5001858759	L=120 M=30x1,5 LHT	MAGNUM MIDLINER PREMIUM 2 KERAX
0186613 	5000823987	L=105 M=28x1,5 RHT	MIDLINER
0186758 	5000240688 5000242475 5000242479 5000242485	L=135 M=30x1,5 RHT	MAGNUM MIDLINER MIDLUM

TESTE STERZO - TIE RODS END

RIF. OCAP OCAP REF.	RIF. ORIG O.E. NUMBER	NOTE REMARKS	MODELLO / DESCRIZIONE MODEL / DESCRIPTION
0187723 	5001852452 5001858763 50 01 852 452 50 01 858 763	L=150 M=30x1,5 RHT	PREMIUM MIDLINER
0187884 	5001860770	L=100 M=24x1,5 RHT	MASCOTT
0197884 	5001860769	L=100 M=24x1,5 LHT	MASCOTT
0187903 	5001867774 5001866165	L=120 M=32x1,5 RHT	MAGNUM PREMIUM - PREMIUM 2 KERAX
0188994 	7420937674	L=140 M=30x1,5 RHT	MAGNUM MIDLINER MIDLUM PREMIUM 2
0196599 	5001832579	L=120 M=38x1,5 LHT	MIDLINER
0287291 	7485114029 5000792132	L=95 M=24x1,5 RHT	MAGNUM PREMIUM
0287320 	5001823718	L=86 M=30x1,5 RHT	KERAX



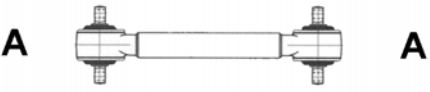
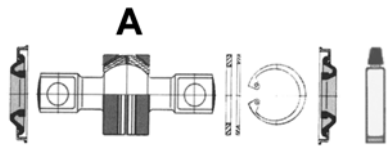
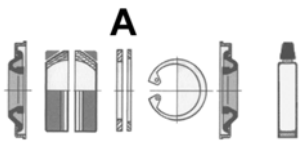
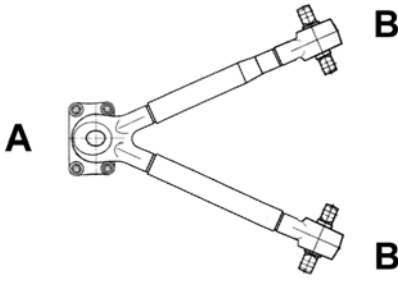
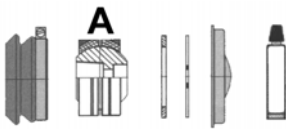
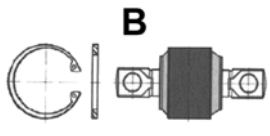

TESTE STERZO - TIE RODS END

RIF. OCAP OCAP REF.	RIF. ORIG O.E. NUMBER	NOTE REMARKS	MODELLO / DESCRIZIONE MODEL / DESCRIPTION
0287360 	5001849880	L=90 M=26x1,5 RHT	PREMIUM
0287361 	5001849879	L=75 M=26x1,5 RHT	PREMIUM
0288930 	5001845430 5001830480	L=75 M=26x1,5 RHT	PREMIUM KERAX
0288993 	7403193731 3193731	L=120 M=26x1,5 RHT	PREMIUM 2
0289456 	7421431678	L=120 M=26x1,5 RHT	SERIE C,D,T







BARRE DI REAZIONE - TORQUE RODS

RIF. OCAP OCAP REF.	RIF. ORIG O.E. NUMBER	NOTE REMARKS	MODELLO / DESCRIZIONE MODEL / DESCRIPTION
<p>0807252</p> 	<p>5010094941 5010094838 5001850530 5000750976 5000783574 5010064641</p>	<p>L=575 d=19</p>	<p>MAGNUM KERAX</p>
<p>0907252</p> 	<p>5001014345</p>	<p>l=145 D=65 d=19</p>	
<p>0907595</p> 	<p>5000819413 5001014345</p>	<p>l=145 p=30 d=19</p>	<p>senza perno (without pin)</p>
<p>0807762</p> 	<p>7420829503 7421295227</p>	<p>L=671 T=58 d=21</p>	<p>KERAX</p>
<p>0907762</p> 	<p>7420840820</p>	<p>D=80</p>	
<p>0907763</p> 	<p>7420840815</p>	<p>l=130 p=30 D=85 d=21/26</p>	

BARRE DI REAZIONE - TORQUE RODS

RIF. OCAP OCAP REF.	RIF. ORIG O.E. NUMBER	NOTE REMARKS	MODELLO / DESCRIZIONE MODEL / DESCRIPTION
<p>0807913</p> 	7420741703	L=668	PREMIUM 2 KERAX
<p>0907919</p> 	7420547286	L=130 p=24 D=75 d=19	
<p>0808738</p> 	7421051052	L=510 T=50	SERIE K KERAX
<p>0909994</p> 	7420702095	L=130 p=35 D=95 d=21	
<p>0809443</p> 	7420448089 20448089	L=564 L=111/115 d=17/19	MIDLUM

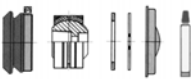
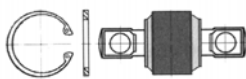





KIT DI SOSPENSIONE - SUSPENSION KITS

RIF. OCAP OCAP REF.	RIF. ORIG O.E. NUMBER	NOTE REMARKS	MODELLO / DESCRIZIONE MODEL / DESCRIPTION
0907252 	5001014345	l=145 D=65 d=19	MAGNUM KERAX
0907304 	5001842337	l=152 p=24 D1=85 d=21	KERAX
0907359 	7420702096	l=130 p=30 D=70 d=21	KERAX
0907528 	7485104224	l=115 p=24 D=75 d=17	PREMIUM KERAX MIDLUM
0907595 	5000819413 5001014345	l=145 p=30 d=19	MAGNUM KERAX
0907762 	7420840820	D=80	KERAX
0907763 	7420840815	l=130 p=30 D=85 d=21/26	KERAX
0907919 	7420547286	l=130 p=24 D=75 d=19	PREMIUM 2 KERAX

KIT DI SOSPENSIONE - SUSPENSION KITS

RIF. OCAP OCAP REF.	RIF. ORIG O.E. NUMBER	NOTE REMARKS	MODELLO / DESCRIZIONE MODEL / DESCRIPTION
<p>0909994</p> 	<p>7420702095</p>	<p>l=130 p=35 D=95 d=21</p>	<p>SERIE K KERAX</p>



STABILIZZATORI - STABILIZERS

RIF. OCAP OCAP REF.	RIF. ORIG O.E. NUMBER	NOTE REMARKS	MODELLO / DESCRIZIONE MODEL / DESCRIPTION
0507123 	7422325247 7421446333	L=325 T=30	SERIE C,K,T
0509374 	7420800194	L=275 T=30	KERAX
0509433 	7420850454	L=300 T=30	KERAX
0587990 	5000450713	L=335 T=28	MIDLINER - MIDLUM
0597990 	5000450714	L=335 T=28	MIDLINER - MIDLUM
0587991 	5010253256	L=280 T=28	MIDLINER - MIDLUM
0597991 	5010253255 5010238594	L=280 T=28	MIDLINER - MIDLUM

TESTE COMANDO CAMBIO - GEAR BOX CONTROL BALL JOINTS

RIF. OCAP OCAP REF.	RIF. ORIG O.E. NUMBER	NOTE REMARKS	MODELLO / DESCRIZIONE MODEL / DESCRIPTION
<p>0187228</p> 	<p>5000807536</p>	<p>L=85 M=14x1,5 RHT</p>	<p>MIDLUM MIDLINER MAGNUM PREMIUM KERAX</p>

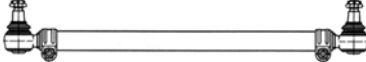

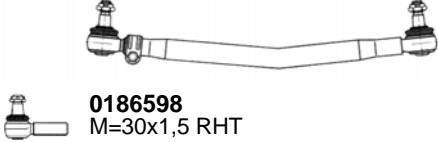
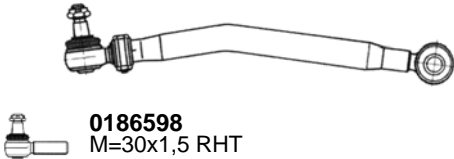
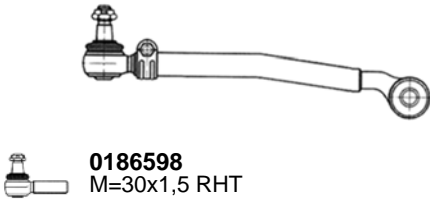
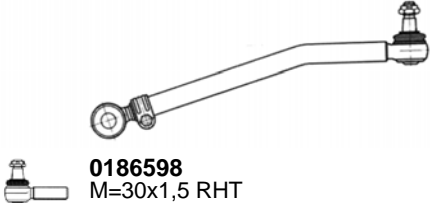
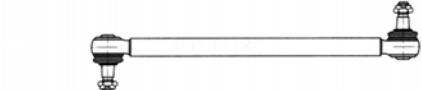
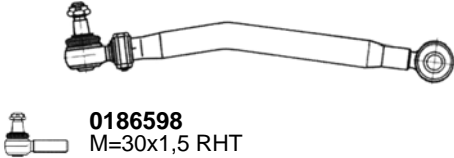

BARRE ACCOPPIAMENTO - TIE RODS

RIF. OCAP OCAP REF.	RIF. ORIG O.E. NUMBER	NOTE REMARKS	MODELLO / DESCRIZIONE MODEL / DESCRIPTION
<p>0506937</p>  <p>0186598 M=30x1,5 RHT</p>	<p>1409918 1897335 1737683 1723895 1501030 1385251</p>	<p>L=1740 T=50</p>	<p>SERIE 4 SERIE P,G,R,T</p>
<p>0506939</p>  <p>0186598 M=30x1,5 RHT 0196598 M=30x1,5 LHT</p>	<p>2146104 1723896 1737684 1897336 2125091 2161884</p>	<p>L=1736 T=40</p>	<p>SERIE 4 SERIE P,G,R,T</p>
<p>0507723</p>  <p>0187723 M=30x1,5 RHT</p>	<p>1395614 2040254 1897333 1734019 1361413 2146105</p>	<p>L=1743 T=62</p>	<p>SERIE 4 SERIE P,G,R,T</p>
<p>0508758</p>  <p>0187894 M=30x1,5 RHT</p>	<p>2146104 1723896 1737684 1897336 2125091 2161884</p>	<p>L=1743 T=52</p>	<p>SERIE P,G,R,T</p>



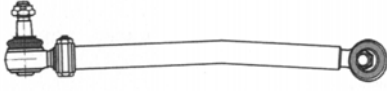

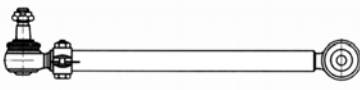
TIRANTI LONGITUDINALI - DRAG LINKS

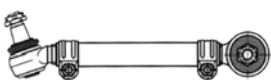
RIF. OCAP OCAP REF.	RIF. ORIG O.E. NUMBER	NOTE REMARKS	MODELLO / DESCRIZIONE MODEL / DESCRIPTION
<p>0506829</p>  <p>0186598 M=30x1,5 RHT</p>	352637	L=947 T=48	SERIE 3
<p>0506869</p>  <p>0186598 M=30x1,5 RHT</p>	1304571	L=915 T=50	SERIE 3
<p>0506888</p>  <p>0186598 M=30x1,5 RHT</p>	345124	L=927 T=50	SERIE 3
<p>0506913</p>  <p>0186598 M=30x1,5 RHT</p>	390784	L=855 T=42	SERIE 3
<p>0506916</p> 	1308643	L=1590 T=40	SERIE 3
<p>0506918</p>  <p>0186598 M=30x1,5 RHT</p>	306981	L=947 T=48	SERIE 3



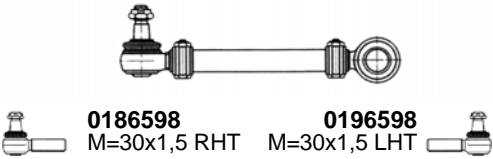

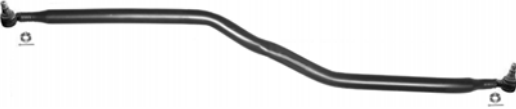



TIRANTI LONGITUDINALI - DRAG LINKS

RIF. OCAP OCAP REF.	RIF. ORIG O.E. NUMBER	NOTE REMARKS	MODELLO / DESCRIZIONE MODEL / DESCRIPTION
<p>0506919</p>  <p>0186598 M=30x1,5 RHT</p>	<p>1369919</p>	<p>L=912 T=50</p>	<p>SERIE 3</p>
<p>0506920</p>  <p>0186598 M=30x1,5 RHT</p>	<p>1379071 1912757 1847311 1768898 1356055 1384025</p>	<p>L=1060 T=52</p>	<p>SERIE 4 SERIE P,G,R,T</p>
<p>0506936</p>  <p>0186598 M=30x1,5 RHT</p>	<p>1112511</p>	<p>L=843 T=50</p>	<p>SERIE 3</p>
<p>0507188</p>  <p>0186598 M=30x1,5 RHT</p>	<p>382774</p>	<p>L=578 T=40</p>	<p>SERIE 3</p>
<p>0507731</p>  <p>0186598 M=30x1,4 RHT</p>	<p>1847312 1769597 1384027 1379072</p>	<p>L=1060 T=52</p>	<p>SERIE 4 SERIE P,G,R,T</p>
<p>0507766</p>  <p>0187723 0196598 M=30x1,5 RHT M=30x1,5 LHT</p>	<p>1343283 1759691</p>	<p>L=435 T=38</p>	<p>SERIE 4 SERIE P,G,R,T</p>



TIRANTI LONGITUDINALI - DRAG LINKS

RIF. OCAP OCAP REF.	RIF. ORIG O.E. NUMBER	NOTE REMARKS	MODELLO / DESCRIZIONE MODEL / DESCRIPTION
<p>0507767</p>  <p>0186598 M=30x1,5 RHT</p> <p>0196598 M=30x1,5 LHT</p>	<p>1343266 1759690</p>	<p>L=495 T=40</p>	<p>SERIE 4 SERIE P,G,R,T</p>
<p>0507999</p> 	<p>1343262 1869413</p>	<p>L=608 T=42</p>	<p>SERIE 4 - SERIE P,G,R,T</p>
<p>0509416</p> 	<p>1393383 1788520</p>	<p>L=1950 T=62</p>	<p>SERIE 4 SERIE P,G,R,T</p>
<p>0509879</p> 	<p>1343264 1732635 2007278</p>	<p>L=1921 T=60</p>	<p>SERIE 4 SERIE P,G,R,T</p>
<p>0509881</p>  <p>0186598 M=30x1,5 RHT</p>	<p>1348269 2007275</p>	<p>L=1062 T=52</p>	<p>SERIE 4 SERIE P,G,R,T</p>









TESTE STERZO - TIE RODS END

RIF. OCAP OCAP REF.	RIF. ORIG O.E. NUMBER	NOTE REMARKS	MODELLO / DESCRIZIONE MODEL / DESCRIPTION
0186598 	283784 468286 395010 1738381 0395010 1767328 0283784	L=120 M=30x1,5 RHT	SERIE 3
0196598 	283783 395009 468285 1358792 1738380	L=120 M=30x1,5 LHT	SERIE 3
0186758 	1337367 352645 352646	L=135 M=30x1,5 RHT	SERIE 4 SERIE P,G,R,T
0196758 	352645 1337366	L=135 M=30x1,5 LHT	SERIE 3
0187894 	1723897 2051041 2154938 2154939	L=145 M=30x1,5 RHT	SERIE P,G,R,T
0188994 	1358793	L=140 M=30x1,5 RHT	SERIE 4 SERIE P,G,R,T
0287360 	1394444	L=90 M=26x1,5 RHT	SERIE 4 SERIE P,G,R,T
0287361 	1394443	L=75 M=26x1,5 RHT	SERIE 4 SERIE P,G,R,T

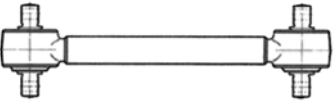



TESTE STERZO - TIE RODS END

RIF. OCAP OCAP REF.	RIF. ORIG O.E. NUMBER	NOTE REMARKS	MODELLO / DESCRIZIONE MODEL / DESCRIPTION
<p>0287684</p> 	<p>1912759</p>	<p>L=95</p> <p>M=26x1,5 RHT</p>	<p>SERIE 4 SERIE P,G,R,T</p>
<p>0289455</p> 	<p>1394447</p>	<p>L=115</p> <p>M=26x1,5 RHT</p>	<p>SERIE 4 SERIE P,G,R,T</p>











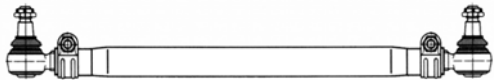

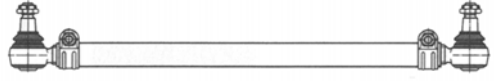
BARRE DI REAZIONE - TORQUE RODS

RIF. OCAP OCAP REF.	RIF. ORIG O.E. NUMBER	NOTE REMARKS	MODELLO / DESCRIZIONE MODEL / DESCRIPTION
<p>0807454</p>  <p>A A</p>	<p>1428349 1326775</p>	<p>L=522 T=46 l=115</p>	<p>SERIE 4 SERIE P,G,R,T</p>
<p>0907528</p>  <p>A</p>	<p>639370 550808 1517403 1102506 1104334 550806</p>	<p>l=115 p=24 D=75 d=17</p>	
<p>0807771</p>  <p>A A</p>	<p>1428347 1399180</p>	<p>L=568 d=17</p>	<p>SERIE 4 SERIE P,G,R,T</p>
<p>0907528</p>  <p>A</p>	<p>639370 550808 1517403 1102506 1104334 550806</p>	<p>l=115 p=24 D=75 d=17</p>	
<p>0808776</p>  <p>A A</p>	<p>1101843 1379423 1393298 1942075</p>	<p>L=752 T=48</p>	<p>SERIE 4 SERIE P,G,R,T</p>
<p>0907591</p>  <p>A</p>	<p>550800 1628671 0003302111</p>	<p>l=115 p=24 D=67 d=17</p>	
<p>0809434</p>  <p>B B</p>	<p>1722582 1440028</p>	<p>L=613,2 T=46</p>	<p>SERIE P,G,R,T</p>
<p>0909434</p>  <p>B</p>	<p>1444472</p>	<p>l=115 p=24 D=70 d=19</p>	











KIT DI SOSPENSIONE - SUSPENSION KITS

RIF. OCAP OCAP REF.	RIF. ORIG O.E. NUMBER	NOTE REMARKS	MODELLO / DESCRIZIONE MODEL / DESCRIPTION
0907259 	638862 639287 1104335 1953248 1435944	l=130 p=30 D=70 d=19	SERIE 4 SERIE P,G,R,T
0907528 	639370 550808 1517403 1102506 1104334 550806	l=115 p=24 D=75 d=17	SERIE 4 SERIE P,G,R,T
0907591 	550800 1628671 0003302111	l=115 p=24 D=67 d=17	SERIE 4 SERIE P,G,R,T
0909434 	1444472	l=115 p=24 D=70 d=19	SERIE P,G,R,T

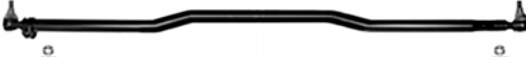

BARRE ACCOPPIAMENTO - TIE RODS

RIF. OCAP OCAP REF.	RIF. ORIG O.E. NUMBER	NOTE REMARKS	MODELLO / DESCRIZIONE MODEL / DESCRIPTION
0507109   0186959 M=30x1,5 RHT 0196959 M=30x1,5 LHT 	1626494 6862225 1606274 1611864 1505855	L=1592 T=42	FL 7 - 10 -12
0507124   0186959 M=30x1,5 RHT 0196959 M=30x1,5 LHT 	3962343 3988711 3986450 1626637	L=1640 T=42	FM 12 FH 12 - 16 FMX
0508736 	21560957 25372885	L=1655 T=60	FE - FE II
0509357   0187686 M=30x1,5 RHT	20392778 21260296	L=1645 T=50	FM 9
0509358   0189896 M=30x1,5 RHT	21260275 3198234	L=1660 T=62	FH 12-16 FMX II
0509359 	20587731 21106938 22159753	L=1660 T=60	FH 12-16 - FMX II
0509436 	22159757	L=1818 T=52	FH 12-FH 16-FM 12





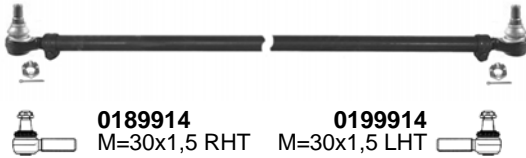

BARRE ACCOPPIAMENTO - TIE RODS

RIF. OCAP OCAP REF.	RIF. ORIG O.E. NUMBER	NOTE REMARKS	MODELLO / DESCRIZIONE MODEL / DESCRIPTION
0509437 	22159765 21367010	L=1818 T=48	FH 16 FMX II
0509468 	21261985 22159764	L=1671 T=60	FH 16 FMX II
0509472   0187686 M=30x1,5 RHT	22159758	L=1025 T=48	FH 12-16 FM 9-12 FMX-FMX II
0509473 	22159755 21192770	L=1693 T=60	FH 16 FMX II
0509894   0187686 M=30x1,5 RHT	20399543 21299034 85115631	L=1818 T=52	FM 9 - 12 FH 12 - 16
0509896   0189896 M=30x1,5 RHT	20393097 21260286 1612254 3985570	L=1640 T=58	FM 7 - 10 - 12 FH 12-16
0509911   0187723 M=30x1,5 RHT	21560963 20824578	L=1686 T=60	FE - FE II











BARRE ACCOPPIAMENTO - TIE RODS

RIF. OCAP OCAP REF.	RIF. ORIG O.E. NUMBER	NOTE REMARKS	MODELLO / DESCRIZIONE MODEL / DESCRIPTION
0509914  0189914 0199914 M=30x1,5 RHT M=30x1,5 LHT	20581086	L=1669 T=42	FM 9 - 12 FH 12 - 16 FMX - FMX II
0509916  0189896 M=30x1,5 RHT	21260274 3198276	L=1634 T=50	FM 9 - 12 FH 12-16 FMX - FMX 2







TIRANTI LONGITUDINALI - DRAG LINKS

RIF. OCAP OCAP REF.	RIF. ORIG O.E. NUMBER	NOTE REMARKS	MODELLO / DESCRIZIONE MODEL / DESCRIPTION
<p>0506967</p>  <p>0186960 M=30x1,5 RHT</p>	<p>1626751 1610338</p>	<p>L=850 T=42</p>	<p>F10 - F12 - F16</p>
<p>0507100</p>  <p>0186960 M=30x1,5 RHT</p>	<p>1592940</p>	<p>L=823 T=50</p>	<p>FL 7 - 10 - 12</p>
<p>0507101</p>  <p>0186960 M=30x1,5 RHT</p>	<p>1592939 85114144</p>	<p>L=823 T=50</p>	<p>FL 7 - 10 - 12</p>
<p>0507107</p>  <p>0186946 M=30x1,5 RHT</p>	<p>1075005</p>	<p>L=863 T=50</p>	<p>FH 12 - 16</p>
<p>0507108</p>  <p>0186946 M=30x1,5 RHT</p>	<p>1691660</p>	<p>L=863 T=52</p>	<p>FH 12 - 16</p>
<p>0507111</p>  <p>0186959 M=30x1,5 RHT</p>	<p>1075663 20393069 3988704</p>	<p>L=861 T=52</p>	<p>FM 7 - 10 - 12 FH 12 - 16</p>





TIRANTI LONGITUDINALI - DRAG LINKS

RIF. OCAP OCAP REF.	RIF. ORIG O.E. NUMBER	NOTE REMARKS	MODELLO / DESCRIZIONE MODEL / DESCRIPTION
0507112   0186959 M=30x1,5 RHT	1075153 20393061 3988695 3988697	L=881 T=52	FM 7 - 10 - 12 FH 12 - 16
0507113   0186959 M=30x1,5 RHT	1628636 85114200	L=881 T=52	FH 12 - 16
0507116   0186612 M=24x1,5 RHT	3124480 20400909 31244809 3124594 6777855 6791948	L=978 T=30	FL6
0507120   0186946 M=30x1,5 RHT	1075664 3988701 20393063	L=861 T=52	FH 12 - 16 FM 12
0507863   0186424 M=30x1,5 RHT	20709844 82165564	L=946 T=42	FL - FL II
0508723 	21560882 21560884 20727843	L=825 T=62	FE - FE II



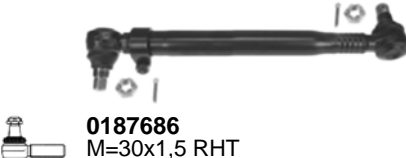



TIRANTI LONGITUDINALI - DRAG LINKS

RIF. OCAP OCAP REF.	RIF. ORIG O.E. NUMBER	NOTE REMARKS	MODELLO / DESCRIZIONE MODEL / DESCRIPTION
<p>0508799</p>  <p>0187686 M=30x1,5 RHT</p>	<p>20390745 21106936</p>	<p>L=885 T=50</p>	<p>FH - FH12 - FH16 FM 7 - FM 9 - FM 12</p>
<p>0509412</p> 	<p>20727840 21560865 21560868</p>	<p>L=830 T=62</p>	<p>FE - FE II</p>
<p>0509439</p>  <p>0186598 M=30x1,5 RHT</p>	<p>20818854</p>	<p>L=900 T=50</p>	<p>FL - FL III</p>
<p>0509441</p> 	<p>24425658 20393089 20442111 20513949</p>	<p>L=2111 T=52</p>	<p>FM 12</p>
<p>0509460</p> 	<p>20727850 21560892 21560894</p>	<p>L=833 T=62</p>	<p>FE-FE II</p>
<p>0509462</p> 	<p>22526504 23341677 21698607 21543888</p>	<p>L=900 T=52</p>	<p>FH 16 FMX II</p>
<p>0509463</p>  <p>0186424 M=30x1,5 RHT</p>	<p>20818840</p>	<p>L=909 T=50</p>	<p>FL - FL II - FL III</p>

TIRANTI LONGITUDINALI - DRAG LINKS

RIF. OCAP OCAP REF.	RIF. ORIG O.E. NUMBER	NOTE REMARKS	MODELLO / DESCRIZIONE MODEL / DESCRIPTION
0509465  0187686 M=30x1,5 RHT	22159741	L=563 T=46	FH 12 FMX
0509466  0188994 M=30x1,5 RHT	22163223	L=825 T=62	FE - FE II
0509475 	22380814 22526506	L=895 T=52	FH16 - FMX II
0509893  0186960 M=30x1,5 RHT	1094219 20453027	L=813 T=60	FL 10 - FL 12
0509897  0186959 M=30x1,5 RHT	20393186 21106930 20375555 3986452	L=863 T=52	FM 7 - 10 - 12 FH 12 - 16 FMX - FMX II







TESTE STERZO - TIE RODS END

RIF. OCAP OCAP REF.	RIF. ORIG O.E. NUMBER	NOTE REMARKS	MODELLO / DESCRIZIONE MODEL / DESCRIPTION
0186598 	20821160 20742127 20745043 20862494	L=125 M=30x1,5 RHT	FL FM 9 - 12
0186612 	1696919	L=105 M=24x1,5 RHT	FL6
0186758 	20862494 20742127 20745043 20821160	L=135 M=30x1,5 RHT	FE II FL II
0186946 	3090727 3110002 3988965 3090472	L=115 M=30x1,5 RHT	FL 10 FM 7 - FM 12
0186959 	1698846 3988965 1507823 3092472 1505759 6884002 6889479 85112073 85125126	L=120 M=30x1,5 RHT	FH 12 - 16 FM 10 - 12 FL 12
0196959 	1698847 1507822 1698533 3092471 1505758 3110001 3988968 6884001 6889478	L=120 M=30x1,5 LHT	FH 12 - 16 FM 10 - 12 FL 12
0186960 	1507826	L=120 M=30x1,5 RHT	FL 7 - 10 - 12

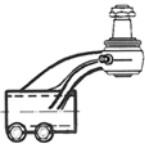





TESTE STERZO - TIE RODS END

RIF. OCAP OCAP REF.	RIF. ORIG O.E. NUMBER	NOTE REMARKS	MODELLO / DESCRIZIONE MODEL / DESCRIPTION
0196960 	1131744	L=120 M=30x1,5 LHT	FL 7 - 10 - 12
0187686 	3093647	L=140 M=30x1,5 RHT	FH 12 - 16 FM 9 - 10 - 12 FMX I - II
0187723 	20894438 21580396	L=150 M=30x1,5 RHT	FE
0188994 	20937674	L=140 M=30x1,5 RHT	FE FL I - II
0189896 	3097228 3099529 21263974 3092189	L=145 M=30x1,5 RHT	FH 12 - 16 FL 12 FM 9 - 10 - 12 FMX I - II
0189914 	20581089	L=136 M=30x1,5 RHT	FH 12 - 16 FM 9 - 12 FMX I - II
0199914 	20710008	L=136 M=30x1,5 LHT	FH 12 - 16 FM 9 - 12 FMX I - II
0196946 	3090728	L=115 M=30x1,5 LHT	FL 10 FM 7 - FM 12

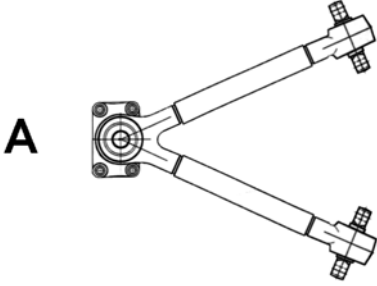
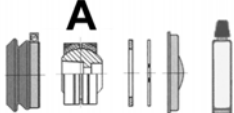

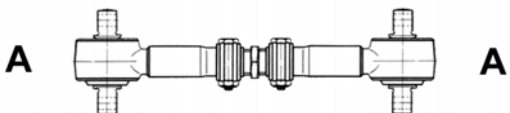

TESTE STERZO - TIE RODS END

RIF. OCAP OCAP REF.	RIF. ORIG O.E. NUMBER	NOTE REMARKS	MODELLO / DESCRIZIONE MODEL / DESCRIPTION
0286964 	1699401 1696901 1131742 6889484	L=168 M=52x1,5 RHT	FL 12 FH 12 - 16
0296964 	1699400 1131741 6889483	L=168 M=52x1,5 LHT	FL 12 FH 12 - 16 FM 10 - 12
0288779 	20374698	L=88 M=26x1,5 RHT	FH 12 - 16 FM 12 FMX
0288993 	3193731 7403193731	L=120 M=26x1,5 RHT	FH 12 - 16 - FM 9 -12 - FMX
0289456 	21431678	L=120 M=26x1,5 RHT	FE II - FMX II
0289923 	3099128 3090291	L=90 M=36x1,5 RHT	FH 12 - 16 FL 12



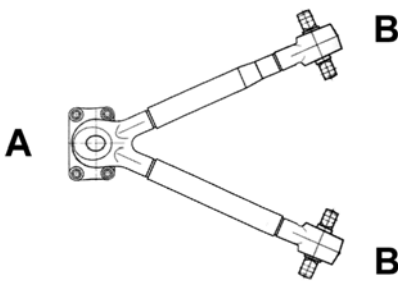
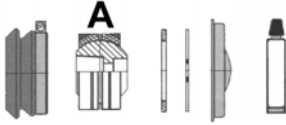
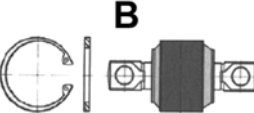



BARRE DI REAZIONE - TORQUE RODS

RIF. OCAP OCAP REF.	RIF. ORIG O.E. NUMBER	NOTE REMARKS	MODELLO / DESCRIZIONE MODEL / DESCRIPTION
0807221 	1080690 1576952 1606200	L=635 d=23	FL 10 - 12
0907683 	273706	D=80 IK=46	
0807222 	1082104 1605035	L=666 T=48	FM 7 - 10 - 12 FH 12 - 16
0907222 	1598588	l=125 p=20 D=91 d=14	
0907224 	1135080	D=91 d=52	
0807687 	8158207 1607079 1581527	L=660 d=21	FL 10 - 12
0907359 	274019 273373 20702096	l=130 p=30 D=70 d=21	





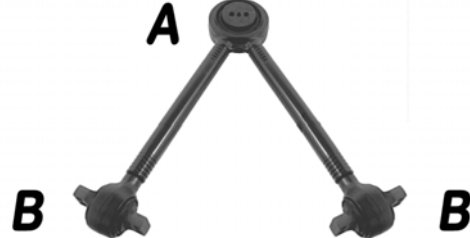

BARRE DI REAZIONE - TORQUE RODS

RIF. OCAP OCAP REF.	RIF. ORIG O.E. NUMBER	NOTE REMARKS	MODELLO / DESCRIZIONE MODEL / DESCRIPTION
<p>0807762</p>  <p>0907762</p>  <p>0907763</p> 	<p>21295227 20829503 21474441 20392649 1626896 1629734 1076639</p> <p>3090712</p> <p>20840815 21295230 3093630 3093631</p>	<p>L=671</p> <p>d=21</p> <p>D=80</p> <p>I=130</p> <p>D=70 d=21</p>	<p>FH 12 - 16 FM 12 FMX - FMX II</p>
<p>0807913</p>  <p>0907919</p> 	<p>20507262 20367004 20741695 20741703</p> <p>20547286</p>	<p>L=662 T=48</p> <p>I=130 p=24 D=75 d=19</p>	<p>FM 9 - 10 - 12 FH 12 - 16 FE</p>
<p>0808738</p>  <p>0909994</p> 	<p>21051052 20522934</p> <p>20702095 273612</p>	<p>L=510</p> <p>I=130 p=35 D=95 d=21</p>	<p>FH 12 - 16 FM 9 - 12 FM - FMX II</p>

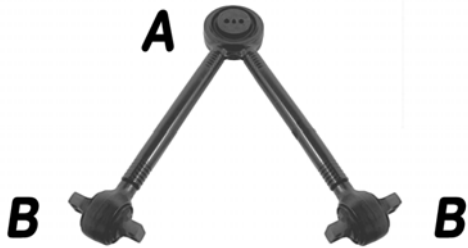



BARRE DI REAZIONE - TORQUE RODS

RIF. OCAP OCAP REF.	RIF. ORIG O.E. NUMBER	NOTE REMARKS	MODELLO / DESCRIZIONE MODEL / DESCRIPTION
0809378  0907528 	20410053 21106157 85104224 3093462 271187	L=799 T=48 l=115 p=24 D=75 d=17	FH 12 - 16 FM 9 - 12
0809381  0909909 	20491771 20556608 20703338 3090452 3092452	L=662 T=48 l=115 p=24 D=75 d=17/20	FH 12 - 16 FM 12 FMX - FMX II
0809385  0909379  0909380 	20556491 3173292 1075255 20554908 3173759 1591689 1628107	L=677 T=48 l=21 D=138 d=14-16 l=145 p=26 D=91 d=15	FM 7 - FM12 - FH 12-FH 16



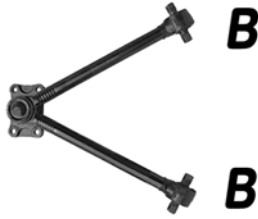





BARRE DI REAZIONE - TORQUE RODS

RIF. OCAP OCAP REF.	RIF. ORIG O.E. NUMBER	NOTE REMARKS	MODELLO / DESCRIZIONE MODEL / DESCRIPTION
<p>0809386</p> 	<p>20556490 3173291 8156991 1628133</p>	<p>L=677 T=48</p>	<p>FH 12 - 16 FM 7 - 12</p>
<p>0909379</p> 	<p>1075255 20554908 3173759 1591689</p>	<p>I=21 D=138 d=14-16</p>	
<p>0909380</p> 	<p>1628107</p>	<p>I=145 p=26 D=91 d=15</p>	
<p>0809443</p> 	<p>20448089 7420448089</p>	<p>L=564 I=111/115 d=17/19</p>	<p>FL - FL III</p>
<p>0809445</p> 	<p>21196798</p>	<p>L=625 I=115 d=17</p>	<p>FH 16 FMX II</p>
<p>0809907</p> 	<p>3172829</p>	<p>L=677 T=48</p>	<p>FL 12 FH 12-16 FM 7 -9- 12</p>
<p>0907529</p> 	<p>274056 276192</p>	<p>I=152 p=35 D=95 d=23</p>	

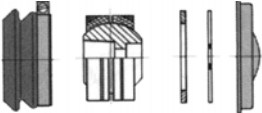

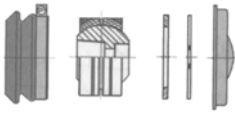



BARRE DI REAZIONE - TORQUE RODS

RIF. OCAP OCAP REF.	RIF. ORIG O.E. NUMBER	NOTE REMARKS	MODELLO / DESCRIZIONE MODEL / DESCRIPTION
0809909 	20382314 20502944 1094466	L=649 T=48 I=115 d=17/20	FL 12 FM 10 - 12
0909909 B 	3090452 3092452	I=115 p=24 D=75 d=17/20	
0809917 A  A	20374444 20517494 20410530 20509018	L=625	FH 12 - 16 FM 9 - 12 FMX - FMX II
0907528 A 	85104224 3093462 271187	I=115 p=24 D=75 d=17	

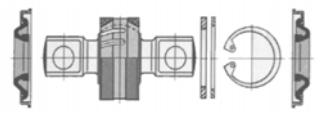
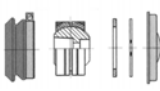
KIT DI SOSPENSIONE - SUSPENSION KITS

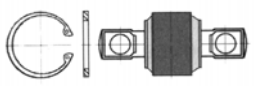
RIF. OCAP OCAP REF.	RIF. ORIG O.E. NUMBER	NOTE REMARKS	MODELLO / DESCRIZIONE MODEL / DESCRIPTION
0907222 	1598588	l=125 p=20 D=91 d=14	FM 7 - 10 -12 FH 12 - 16
0907224 	1135080	D=91 d=52	FM 7 - 10 -12 FH 12 - 16
0907257 	271188	lK=38 T=50 D=65	FH 12 - 16 FL 12 FM 10 - 12
0907296 	274070	l=130 p=24 D=75 d=21	FL 12
0907297 	3093469	lK=38 D=65	FH 16
0907304 	274068	l=152 p=24 D1=85 d=21	FL 12
0907359 	274019 273373 20702096	l=130 p=30 D=70 d=21	FL 12
0907528 	85104224 3093462 271187	l=115 p=24 D=75 d=17	FM 9 - 12 FH 12 - 16 FMX - FMX II

KIT DI SOSPENSIONE - SUSPENSION KITS

RIF. OCAP OCAP REF.	RIF. ORIG O.E. NUMBER	NOTE REMARKS	MODELLO / DESCRIZIONE MODEL / DESCRIPTION
0907529 	274056 276192	l=152 p=35 D=95 d=23	FH 16 FL 12
0907534 	273375 6885513	l=152 p=35 D=80 d=23	FL 12
0907683 	273706	D=80 IK=46	FL 12
0907762 	3090712	D=80	FH 12 - 16 FM 12 FMX - FMX II
0907763 	20840815 21295230 3093630 3093631	l=130 D=70 d=21	FH 12 - 16 FM 12 FMX - FMX II
0907919 	20547286	l=130 p=24 D=75 d=19	FM 9 - 10 - 12 FH 12 - 16 FE
0909379 	1075255 20554908 3173759 1591689	l=21 D=138 d=14-16	FH 12 - 16 FM 7- 12
0909380 	1628107	l=145 p=26 D=91 d=15	FH 12 - 16 FM 7- 12
0909909 	3090452 3092452	l=115 p=24 D=75 d=17/20	FH 12 - 16 FM 9 - 10 - 12 FMX - FMX II





KIT DI SOSPENSIONE - SUSPENSION KITS

RIF. OCAP OCAP REF.	RIF. ORIG O.E. NUMBER	NOTE REMARKS	MODELLO / DESCRIZIONE MODEL / DESCRIPTION
<p>0909994</p> 	<p>20702095 273612</p>	<p>l=130 p=35 D=95 d=21</p>	<p>FH 12 - 16 FM 9 - 12 FM - FMX II</p>

STABILIZZATORI - STABILIZERS

RIF. OCAP OCAP REF.	RIF. ORIG O.E. NUMBER	NOTE REMARKS	MODELLO / DESCRIZIONE MODEL / DESCRIPTION
0507123 	22325247 21446333 3986433	L=325 T=30	FH 12 - 16 FM 12 FMX - FMX II
0507221 	20443062 20994419	L=380 T=36	FH 12 - 16 FM 9 - 12 FMX
0507918 	20443061 20444418 20443065	L=435 T=36	FH 12 - 16 FM 9 - 12 FMX
0508786 	20477807 3944046	L=340 T=30	FH 12 - 16 FM 9 - 12 FMX - FMX II
0508787 	20443063 20994420 3173615 20443067	L=350 T=36	FH 12 - 16 FM 12 FMX
0509449 	21119067 21119056 21287062 21119053	L=390 T=36	FH 12 - 16 FMX - FMX II
0509450 	22318841 21197609	L=373 T=38	FH 16 FMX II
0509451 	21176251 21146255 21176253 21176255 21182239 21146253 21182238 21287063	L=350 T=36	FH 12 - 16 FM 12 FMX - FMX II

STABILIZZATORI - STABILIZERS

RIF. OCAP OCAP REF.	RIF. ORIG O.E. NUMBER	NOTE REMARKS	MODELLO / DESCRIZIONE MODEL / DESCRIPTION
0509452 	22318844 21209705	L=443 T=38	FH 16 FMX - FMX II
0509453 	3987356	L=350 T=36	FM 12
0509905 	3987354 3173613	L=435 T=36	FM 12 FH 12
0509915 	21287061 21119064	L=435 T=36	FM FH 12 - 16 FMX - FMX II

RIF. ORIG O.E. NUMBER	RIF. OCAP REF. OCAP	MARCA	PAG.	RIF. ORIG O.E. NUMBER	RIF. OCAP REF. OCAP	MARCA	PAG.
0003220323	0508968	MERCEDES	5-21	0004609505	0507967	MERCEDES	5-9
0003220423	0508969	MERCEDES	5-21	0004609805	0507627	MERCEDES	5-6
0003220623	0508968	MERCEDES	5-21	0004609905	0507627	MERCEDES	5-6
0003220723	0508969	MERCEDES	5-21	0005861035	0907533	MAN	4-9
0003301235	0186612	MERCEDES	5-12	0005861235	0907330	MERCEDES	5-14
0003301335	0196612	MERCEDES	5-12	0005861533	0907586	IVECO	3-13
0003301411	0907635	MERCEDES	5-15	0013300135	0186424	MERCEDES	5-11
0003301435	0186613	MERCEDES	5-12	0013300235	0186424	MERCEDES	5-11
0003301535	0186613	MERCEDES	5-12	0013300335	0186547	MERCEDES	5-11
0003302111	0907591	SCANIA	8-7	0013306635	0196424	MERCEDES	5-11
0003307135	0186613	MERCEDES	5-12	0013308835	0196424	MERCEDES	5-11
0003307335	0186424	MERCEDES	5-11	0014600448	0186551	MERCEDES	5-11
0003307535	0196612	MERCEDES	5-12	0014600548	0196961	MERCEDES	5-13
0003307635	0196612	MERCEDES	5-12	0014600705	0507968	MERCEDES	5-9
0003309335	0186613	MERCEDES	5-12	0014600805	0507968	MERCEDES	5-9
0003309535	0186613	MERCEDES	5-12	0014601105	0507961	MERCEDES	5-8
0003309735	0186612	MERCEDES	5-12	0014601148	0186551	MERCEDES	5-11
0003309935	0186612	MERCEDES	5-12	0014601305	0507911	MERCEDES	5-8
0003382129	0186613	MERCEDES	5-12	0014601405	0507911	MERCEDES	5-8
0003383429	0186612	MERCEDES	5-12	0014601448	0196598	MERCEDES	5-11
0003406218	0196424	MERCEDES	5-11	0014601505	0507587	MERCEDES	5-1
0003500413	0907330	MERCEDES	5-14	0014601648	0288930	MERCEDES	5-13
0003502005	0907984	MERCEDES	5-20	0014601748	0186551	MERCEDES	5-11
0003502105	0907622	MERCEDES	5-18	0014601848	0186598	MERCEDES	5-11
0003502205	0907609	MERCEDES	5-17	0014602248	0186598	MERCEDES	5-11
0003502305	0907634	MERCEDES	5-14	0014602348	0196598	MERCEDES	5-11
0003502405	0907774	IVECO	3-17	0014602448	0186551	MERCEDES	5-11
0003502405	0907774	MERCEDES	5-16	0014602548	0196961	MERCEDES	5-13
0003502505	0907599	MERCEDES	5-14	0014602948	0187916	MERCEDES	5-13
0003502705	0907547	MERCEDES	5-15	0014603148	0186424	MERCEDES	5-11
0003503105	0908991	MERCEDES	5-20	0014603448	0186424	MERCEDES	5-11
0003503205	0907609	MERCEDES	5-17	0014603648	0196598	MERCEDES	5-11
0003503605	0907908	MERCEDES	5-16	0014603848	0187959	MERCEDES	5-13
0003503705	0907909	MERCEDES	5-16	0014604148	0187789	MERCEDES	5-13
0003504005	0907634	MERCEDES	5-14	0014604348	0196424	MERCEDES	5-11
0003504405	0907634	MERCEDES	5-14	0014604448	0186424	MERCEDES	5-11
0003504505	0907609	MERCEDES	5-17	0014604848	0187959	MERCEDES	5-13
0003504605	0907622	MERCEDES	5-18	0014605148	0187959	MERCEDES	5-13
0003504705	0907984	MERCEDES	5-20	0014606705	0506585	MERCEDES	5-4
0003504905	0907774	MERCEDES	5-16	0014607005	0507968	MERCEDES	5-9
0004601048	0186598	MERCEDES	5-11	0014607105	0507967	MERCEDES	5-9
0004601748	0187467	MERCEDES	5-12	0014607305	0507587	MERCEDES	5-1
0004602648	0187146	MERCEDES	5-12	0014607448	0197146	MERCEDES	5-12
0004602848	0186598	MERCEDES	5-11	0014607648	0186551	MERCEDES	5-11
0004602948	0186598	MERCEDES	5-11	0014607748	0186598	MERCEDES	5-11
0004603448	0196598	MERCEDES	5-11	0014607848	0196598	MERCEDES	5-11
0004603548	0196598	MERCEDES	5-11	0014607948	0196961	MERCEDES	5-13
0004604948	0287684	MERCEDES	5-13	0014608348	0186424	MERCEDES	5-11
0004605748	0186551	MERCEDES	5-11	0014608448	0186424	MERCEDES	5-11
0004606148	0196961	MERCEDES	5-13	0014608648	0187959	MERCEDES	5-13
0004606848	0186551	MERCEDES	5-11	0014609805	0507632	MERCEDES	5-6
0004606948	0196961	MERCEDES	5-13	0014609905	0507632	MERCEDES	5-6
0004607048	0186551	MERCEDES	5-11	0014609948	0187959	MERCEDES	5-13
0004607105	0506585	MERCEDES	5-4	0023301535	0186424	MERCEDES	5-11
0004607148	0196961	MERCEDES	5-13	0024600148	0186598	MERCEDES	5-11
0004607205	0506585	MERCEDES	5-4	0024600405	0507961	MERCEDES	5-8
0004607548	0186551	MERCEDES	5-11	0024600505	0507911	MERCEDES	5-8

RIF. ORIG O.E. NUMBER	RIF. OCAP REF. OCAP	MARCA	PAG.	RIF. ORIG O.E. NUMBER	RIF. OCAP REF. OCAP	MARCA	PAG.
0024600648	0288930	MERCEDES	5-13	0698724	0907489	DAF	2-9
0024604305	0507630	MERCEDES	5-6	093161371	0907586	IVECO	3-13
0024604405	0507630	MERCEDES	5-6	094038	0506430	DAF	2-3
0024604505	0507789	MERCEDES	5-7	1075005	0507107	VOLVO	9-4
0024604605	0507789	MERCEDES	5-7	1075153	0507112	VOLVO	9-5
0024604705	0507631	MERCEDES	5-6	1075255	0909379	VOLVO	9-13
0024604805	0507631	MERCEDES	5-6	1075663	0507111	VOLVO	9-4
0024604905	0507615	MERCEDES	5-5	1075664	0507120	VOLVO	9-5
0024605005	0507615	MERCEDES	5-5	1076639	0807762	VOLVO	9-12
0024605205	0507912	MERCEDES	5-8	1080690	0807221	VOLVO	9-11
0024605905	0507965	MERCEDES	5-8	1082104	0807222	VOLVO	9-11
0024606005	0507965	MERCEDES	5-8	1094219	0509893	VOLVO	9-7
0024606105	0507962	MERCEDES	5-8	1094466	0809909	VOLVO	9-15
0024606405	0507632	MERCEDES	5-6	1101843	0808776	SCANIA	8-7
0024608605	0508957	MERCEDES	5-9	1102506	0907528	SCANIA	8-7
0024608705	0508957	MERCEDES	5-9	1104334	0907528	SCANIA	8-7
0024608805	0509461	MERCEDES	5-9	1104335	0907259	SCANIA	8-8
0024608905	0509461	MERCEDES	5-9	1112511	0506936	SCANIA	8-3
0024609605	0507614	MERCEDES	5-5	11200265-0	0506588	NISSAN	6-1
0024609705	0507614	MERCEDES	5-5	11200360-0	0186592	NISSAN	6-3
0034600705	0507963	MERCEDES	5-8	11200360-0A	0186592	NISSAN	6-3
0034601805	0507642	MERCEDES	5-7	11200360-0B	0186592	NISSAN	6-3
0034601905	0507642	MERCEDES	5-7	11200361-0	0196592	NISSAN	6-3
0034603105	0507961	MERCEDES	5-8	11200361-0A	0196592	NISSAN	6-3
0034603205	0507911	MERCEDES	5-8	11200361-0B	0196592	NISSAN	6-3
0034603305	0507587	MERCEDES	5-1	11200454-0	0506590	NISSAN	6-2
0034604105	0507965	MERCEDES	5-8	112004540	0506590	NISSAN	6-2
0034604205	0507962	MERCEDES	5-8	1131741	0296964	VOLVO	9-10
0034604605	0507887	MERCEDES	5-7	1131742	0286964	VOLVO	9-10
0034604705	0507963	MERCEDES	5-8	1131744	0196960	VOLVO	9-9
0034604805	0507630	MERCEDES	5-6	1135080	0907224	VOLVO	9-11
0034604905	0507631	MERCEDES	5-6	1149875	0187723	DAF	2-6
0034605705	0507614	MERCEDES	5-5	1149907	0186598	DAF	2-6
0034605805	0507642	MERCEDES	5-7	11505036-0	0506591	NISSAN	6-2
0034605905	0507827	MERCEDES	5-7	1152350	0186598	DAF	2-6
0034606205	0507962	MERCEDES	5-8	1228115	0196598	DAF	2-6
0034608605	0509470	MERCEDES	5-10	1229944	0186424	DAF	2-6
0094038	0506430	DAF	2-3	1252284	0907296	DAF	2-12
0110197	0186613	DAF	2-6	1257890	0186598	DAF	2-6
01902137	0807363	IVECO	3-17	1261101	0807555	DAF	2-10
0267743	0807501	DAF	2-9	1270853	0507933	DAF	2-1
0273203	0287503	DAF	2-8	1270854	0507934	DAF	2-1
0283784	0186598	SCANIA	8-5	1271124	0907258	DAF	2-10
0288281	0507934	DAF	2-1	1286343	0506432	DAF	2-1
03304800A	0907533	MAN	4-9	1291060	0506433	DAF	2-3
0386930	0187228	DAF	2-14	1294251	0807927	DAF	2-10
0395010	0186598	SCANIA	8-5	1297572	0507942	DAF	2-1
042489573	0186758	IVECO	3-9	1304571	0506869	SCANIA	8-2
0513757	0907359	DAF	2-9	1308643	0506916	SCANIA	8-2
0554765	0506430	DAF	2-3	1315447	0196424	DAF	2-7
0649819	0807525	DAF	2-9	1319838	0196424	DAF	2-7
0689748	0907528	DAF	2-12	1321936	0907927	DAF	2-10
0691704	0907257	DAF	2-12	1326775	0807454	SCANIA	8-7
0691709	0907359	DAF	2-9	1326896	0186424	DAF	2-6
0693778	0907595	DAF	2-13	1329134	0196598	DAF	2-6
0696320	0907525	DAF	2-9	1331925	0186424	DAF	2-6
0696321	0907529	DAF	2-10	1332123	0196424	DAF	2-7

RIF. ORIG O.E. NUMBER	RIF. OCAP REF. OCAP	MARCA	PAG.	RIF. ORIG O.E. NUMBER	RIF. OCAP REF. OCAP	MARCA	PAG.
1337366	0196758	SCANIA	8-5	1435944	0907259	SCANIA	8-8
1337367	0186758	SCANIA	8-5	1440028	0809434	SCANIA	8-7
1337644	0507934	DAF	2-1	1444472	0909434	SCANIA	8-7
1343262	0507999	SCANIA	8-4	1448063	0507948	DAF	2-4
1343264	0509879	SCANIA	8-4	1448064	0509464	DAF	2-4
1343266	0507767	SCANIA	8-4	1451118	0507937	DAF	2-3
1343283	0507766	SCANIA	8-3	1451122	0507936	DAF	2-3
1348269	0509881	SCANIA	8-4	1451129	0507938	DAF	2-3
1351734	0506433	DAF	2-3	1501030	0506937	SCANIA	8-1
1353391	0507933	DAF	2-1	1505758	0196959	VOLVO	9-8
1356055	0506920	SCANIA	8-3	1505759	0186959	VOLVO	9-8
1358792	0196598	SCANIA	8-5	1505855	0507109	VOLVO	9-1
1358793	0188994	SCANIA	8-5	1507822	0196959	VOLVO	9-8
1361155	0507942	DAF	2-1	1507823	0186959	VOLVO	9-8
1361413	0507723	SCANIA	8-1	1507826	0186960	VOLVO	9-8
1361649	0807501	DAF	2-9	1517403	0907528	SCANIA	8-7
1361650	0807501	DAF	2-9	1576952	0807221	VOLVO	9-11
1361651	0807489	DAF	2-9	1581527	0807687	VOLVO	9-11
1361652	0807930	DAF	2-10	1591689	0909379	VOLVO	9-13
1363859	0507948	DAF	2-4	1592939	0507101	VOLVO	9-4
1368270	0807489	DAF	2-9	1592940	0507100	VOLVO	9-4
1369919	0506919	SCANIA	8-3	1598588	0907222	VOLVO	9-11
1373135	0186613	DAF	2-6	1602821	0507948	DAF	2-4
1373137	0196613	DAF	2-6	1603789	0186598	DAF	2-6
1373878	0509464	DAF	2-4	1603883	0187723	DAF	2-6
1376730	0907297	DAF	2-12	1604247	0196168	DAF	2-7
1379071	0506920	SCANIA	8-3	1604248	0186168	DAF	2-6
1379072	0507731	SCANIA	8-3	1605035	0807222	VOLVO	9-11
1379423	0808776	SCANIA	8-7	1606200	0807221	VOLVO	9-11
1380417	0507938	DAF	2-3	1606274	0507109	VOLVO	9-1
1384025	0506920	SCANIA	8-3	1607079	0807687	VOLVO	9-11
1384027	0507731	SCANIA	8-3	1610338	0506967	VOLVO	9-4
1385251	0506937	SCANIA	8-1	1611088	0196598	DAF	2-6
1385499	0506433	DAF	2-3	1611864	0507109	VOLVO	9-1
1390932	0807489	DAF	2-9	1612254	0509896	VOLVO	9-2
1392640	0507936	DAF	2-3	1618048	0186598	DAF	2-6
1393298	0808776	SCANIA	8-7	1620436	0807930	DAF	2-10
1393383	0509416	SCANIA	8-4	1620437	0807525	DAF	2-9
1394443	0287361	SCANIA	8-5	1626494	0507109	VOLVO	9-1
1394444	0287360	SCANIA	8-5	1626637	0507124	VOLVO	9-1
1394447	0289455	SCANIA	8-6	1626751	0506967	VOLVO	9-4
1395614	0507723	SCANIA	8-1	1626896	0807762	VOLVO	9-12
1395993	0509946	DAF	2-5	1628107	0909380	VOLVO	9-13
1395994	0507947	DAF	2-3	1628133	0809386	VOLVO	9-14
1395995	0509947	DAF	2-5	1628636	0507113	VOLVO	9-5
1398368	0907257	DAF	2-12	1628671	0907591	SCANIA	8-7
1399180	0807771	SCANIA	8-7	1629734	0807762	VOLVO	9-12
1399724	0287503	DAF	2-8	1656428	0807501	DAF	2-9
1401937	0509941	DAF	2-4	1663207	0807501	DAF	2-9
1401942	0197928	DAF	2-7	1676776	0909447	DAF	2-11
1403898	0509943	DAF	2-5	1685552	0188994	DAF	2-7
1405309	0509943	DAF	2-5	1689605	0196608	DAF	2-7
1406600	0509939	DAF	2-4	1691660	0507108	VOLVO	9-4
1409918	0506937	SCANIA	8-1	1696901	0286964	VOLVO	9-10
1426101	0509474	DAF	2-4	1696919	0186612	VOLVO	9-8
1428347	0807771	SCANIA	8-7	1698533	0196959	VOLVO	9-8
1428349	0807454	SCANIA	8-7	1698846	0186959	VOLVO	9-8

RIF. ORIG O.E. NUMBER	RIF. OCAP REF. OCAP	MARCA	PAG.	RIF. ORIG O.E. NUMBER	RIF. OCAP REF. OCAP	MARCA	PAG.
1698847	0196959	VOLVO	9-8	20392778	0509357	VOLVO	9-1
1699400	0296964	VOLVO	9-10	20393061	0507112	VOLVO	9-5
1699401	0286964	VOLVO	9-10	20393063	0507120	VOLVO	9-5
1700000	0507949	DAF	2-1	20393069	0507111	VOLVO	9-4
1700913	0509939	DAF	2-4	20393089	0509441	VOLVO	9-6
1703472	0186168	DAF	2-6	20393097	0509896	VOLVO	9-2
1703473	0196168	DAF	2-7	20393186	0509897	VOLVO	9-7
1705907	0186168	DAF	2-6	20399543	0509894	VOLVO	9-2
1705908	0196168	DAF	2-7	20400909	0507116	VOLVO	9-5
1722582	0809434	SCANIA	8-7	2040254	0507723	SCANIA	8-1
1723895	0506937	SCANIA	8-1	20410053	0809378	VOLVO	9-13
1723896	0506939	SCANIA	8-1	20410530	0809917	VOLVO	9-15
1723897	0187894	SCANIA	8-5	20442111	0509441	VOLVO	9-6
1732635	0509879	SCANIA	8-4	20443061	0507918	VOLVO	9-19
1732973	0509438	DAF	2-1	20443062	0507221	VOLVO	9-19
1734019	0507723	SCANIA	8-1	20443063	0508787	VOLVO	9-19
1737683	0506937	SCANIA	8-1	20443065	0507918	VOLVO	9-19
1737684	0506939	SCANIA	8-1	20443067	0508787	VOLVO	9-19
1738380	0196598	SCANIA	8-5	20444418	0507918	VOLVO	9-19
1738381	0186598	SCANIA	8-5	20448089	0809443	RENAULT V.I.	7-13
1743554	0186613	DAF	2-6	20448089	0809443	VOLVO	9-14
1743594	0196613	DAF	2-6	20453027	0509893	VOLVO	9-7
1759690	0507767	SCANIA	8-4	20477807	0508786	VOLVO	9-19
1759691	0507766	SCANIA	8-3	20491771	0809381	VOLVO	9-13
1767328	0186598	SCANIA	8-5	20502944	0809909	VOLVO	9-15
1768898	0506920	SCANIA	8-3	20507262	0807913	VOLVO	9-12
1769597	0507731	SCANIA	8-3	20509018	0809917	VOLVO	9-15
1788520	0509416	SCANIA	8-4	2051041	0187894	SCANIA	8-5
1793875	0807489	DAF	2-9	20513949	0509441	VOLVO	9-6
1793876	0807930	DAF	2-10	20517494	0809917	VOLVO	9-15
1793877	0807525	DAF	2-9	20522934	0808738	VOLVO	9-12
1807596	0509469	DAF	2-2	20547286	0907919	VOLVO	9-12
1817809	0807501	DAF	2-9	20554908	0909379	VOLVO	9-13
1828523	0509459	DAF	2-4	20556490	0809386	VOLVO	9-14
1847311	0506920	SCANIA	8-3	20556491	0809385	VOLVO	9-13
1847312	0507731	SCANIA	8-3	20556608	0809381	VOLVO	9-13
1869413	0507999	SCANIA	8-4	20581086	0509914	VOLVO	9-3
1897333	0507723	SCANIA	8-1	20581089	0189914	VOLVO	9-9
1897335	0506937	SCANIA	8-1	20587731	0509359	VOLVO	9-1
1897336	0506939	SCANIA	8-1	20702095	0909994	VOLVO	9-12
1902296	0196168	DAF	2-7	20702096	0907359	VOLVO	9-11
1902942	0509459	DAF	2-4	20703338	0809381	VOLVO	9-13
1902997	0186168	DAF	2-6	20709844	0507863	VOLVO	9-5
1903652	0280515	IVECO	3-10	20710008	0199914	VOLVO	9-9
1912757	0506920	SCANIA	8-3	20727840	0509412	VOLVO	9-6
1912759	0287684	SCANIA	8-6	20727843	0508723	VOLVO	9-5
1942075	0808776	SCANIA	8-7	20727850	0509460	VOLVO	9-6
1953248	0907259	SCANIA	8-8	20741695	0807913	VOLVO	9-12
2007275	0509881	SCANIA	8-4	20741703	0807913	VOLVO	9-12
2007278	0509879	SCANIA	8-4	20742127	0186598	VOLVO	9-8
20367004	0807913	VOLVO	9-12	20745043	0186598	VOLVO	9-8
20374444	0809917	VOLVO	9-15	20818840	0509463	VOLVO	9-6
20374698	0288779	VOLVO	9-10	20818854	0509439	RENAULT V.I.	7-7
20375555	0509897	VOLVO	9-7	20818854	0509439	VOLVO	9-6
20382314	0809909	VOLVO	9-15	20821160	0186598	VOLVO	9-8
20390745	0508799	VOLVO	9-6	20824578	0509911	VOLVO	9-2
20392649	0807762	VOLVO	9-12	20829503	0807762	VOLVO	9-12

RIF. ORIG O.E. NUMBER	RIF. OCAP REF. OCAP	MARCA	PAG.	RIF. ORIG O.E. NUMBER	RIF. OCAP REF. OCAP	MARCA	PAG.
20840815	0907763	VOLVO	9-12	21580396	0187723	VOLVO	9-9
20862494	0186598	VOLVO	9-8	2161884	0506939	SCANIA	8-1
20894438	0187723	VOLVO	9-9	21698607	0509462	VOLVO	9-6
20937674	0188994	VOLVO	9-9	22159741	0509465	VOLVO	9-7
20994419	0507221	VOLVO	9-19	22159753	0509359	VOLVO	9-1
20994420	0508787	VOLVO	9-19	22159755	0509473	VOLVO	9-2
21051052	0808738	VOLVO	9-12	22159757	0509436	VOLVO	9-1
21106157	0809378	VOLVO	9-13	22159758	0509472	VOLVO	9-2
21106930	0509897	VOLVO	9-7	22159764	0509468	VOLVO	9-2
21106936	0508799	VOLVO	9-6	22159765	0509437	VOLVO	9-2
21106938	0509359	VOLVO	9-1	22163223	0509466	VOLVO	9-7
21119053	0509449	VOLVO	9-19	22318841	0509450	VOLVO	9-19
21119056	0509449	VOLVO	9-19	22318844	0509452	VOLVO	9-20
21119064	0509915	VOLVO	9-20	22325247	0507123	VOLVO	9-19
21119067	0509449	VOLVO	9-19	22380814	0509475	VOLVO	9-7
21146253	0509451	VOLVO	9-19	22526504	0509462	VOLVO	9-6
21146255	0509451	VOLVO	9-19	22526506	0509475	VOLVO	9-7
21176251	0509451	VOLVO	9-19	23341677	0509462	VOLVO	9-6
21176253	0509451	VOLVO	9-19	24425658	0509441	VOLVO	9-6
21176255	0509451	VOLVO	9-19	25372885	0508736	VOLVO	9-1
21182238	0509451	VOLVO	9-19	257890	0186598	DAF	2-6
21182239	0509451	VOLVO	9-19	271187	0907528	VOLVO	9-13
21192770	0509473	VOLVO	9-2	271188	0907257	VOLVO	9-16
21196798	0809445	VOLVO	9-14	273373	0907359	VOLVO	9-11
21197609	0509450	VOLVO	9-19	273375	0907534	VOLVO	9-17
21209705	0509452	VOLVO	9-20	273612	0909994	VOLVO	9-12
2125091	0506939	SCANIA	8-1	273706	0907683	VOLVO	9-11
21260274	0509916	VOLVO	9-3	274019	0907359	VOLVO	9-11
21260275	0509358	VOLVO	9-1	274056	0907529	VOLVO	9-14
21260286	0509896	VOLVO	9-2	274068	0907304	VOLVO	9-16
21260296	0509357	VOLVO	9-1	274070	0907296	VOLVO	9-16
21261985	0509468	VOLVO	9-2	276192	0907529	VOLVO	9-14
21263974	0189896	VOLVO	9-9	283783	0196598	SCANIA	8-5
21287061	0509915	VOLVO	9-20	283784	0186598	SCANIA	8-5
21287062	0509449	VOLVO	9-19	288281	0507934	DAF	2-1
21287063	0509451	VOLVO	9-19	2966321	0186613	IVECO	3-9
21295227	0807762	VOLVO	9-12	2966635	0186613	IVECO	3-9
21295230	0907763	VOLVO	9-12	2966688	0186424	IVECO	3-8
21299034	0509894	VOLVO	9-2	2966891	0186424	IVECO	3-8
21367010	0509437	VOLVO	9-2	2969507	0196613	IVECO	3-9
2141265	0809447	DAF	2-11	2980884	0907258	DAF	2-10
21431678	0289456	VOLVO	9-10	2980884	0907258	IVECO	3-13
21446333	0507123	VOLVO	9-19	2984511	0196424	IVECO	3-8
2146104	0506939	SCANIA	8-1	2992593	0602749	IVECO	3-12
2146105	0507723	SCANIA	8-1	3023300035	0196424	MERCEDES	5-11
21474441	0807762	VOLVO	9-12	3023300135	0196424	MERCEDES	5-11
21543888	0509462	VOLVO	9-6	3023300235	0196424	MERCEDES	5-11
2154938	0187894	SCANIA	8-5	3023300335	0196424	MERCEDES	5-11
2154939	0187894	SCANIA	8-5	3023300355	0196424	MERCEDES	5-11
21560865	0509412	VOLVO	9-6	306981	0506918	SCANIA	8-2
21560868	0509412	VOLVO	9-6	3090291	0289923	VOLVO	9-10
21560882	0508723	VOLVO	9-5	3090452	0909909	VOLVO	9-13
21560884	0508723	VOLVO	9-5	3090472	0186946	VOLVO	9-8
21560892	0509460	VOLVO	9-6	3090712	0907762	VOLVO	9-12
21560894	0509460	VOLVO	9-6	3090727	0186946	VOLVO	9-8
21560957	0508736	VOLVO	9-1	3090728	0196946	VOLVO	9-9
21560963	0509911	VOLVO	9-2	3092189	0189896	VOLVO	9-9

RIF. ORIG O.E. NUMBER	RIF. OCAP REF. OCAP	MARCA	PAG.	RIF. ORIG O.E. NUMBER	RIF. OCAP REF. OCAP	MARCA	PAG.
3092452	0909909	VOLVO	9-13	3987354	0509905	VOLVO	9-20
3092471	0196959	VOLVO	9-8	3987356	0509453	VOLVO	9-20
3092472	0186959	VOLVO	9-8	3988695	0507112	VOLVO	9-5
3093462	0907528	VOLVO	9-13	3988697	0507112	VOLVO	9-5
3093469	0907297	VOLVO	9-16	3988701	0507120	VOLVO	9-5
3093630	0907763	VOLVO	9-12	3988704	0507111	VOLVO	9-4
3093631	0907763	VOLVO	9-12	3988711	0507124	VOLVO	9-1
3093647	0187686	VOLVO	9-9	3988965	0186946	VOLVO	9-8
3097228	0189896	VOLVO	9-9	3988968	0196959	VOLVO	9-8
3099128	0289923	VOLVO	9-10	4018037	0196603	IVECO	3-8
3099529	0189896	VOLVO	9-9	4054600005	0507617	MERCEDES	5-6
3110001	0196959	VOLVO	9-8	4054600305	0507617	MERCEDES	5-6
3110002	0186946	VOLVO	9-8	4054600605	0507617	MERCEDES	5-6
311300	0196424	DAF	2-7	41002119	0291786	IVECO	3-28
3124480	0507116	VOLVO	9-5	41002770	0807211	IVECO	3-14
31244809	0507116	VOLVO	9-5	41003268	0807292	IVECO	3-15
3124594	0507116	VOLVO	9-5	41005450	0506932	IVECO	3-1
3172829	0809907	VOLVO	9-14	41005451	0506932	IVECO	3-1
3173291	0809386	VOLVO	9-14	41005463	0506931	IVECO	3-4
3173292	0809385	VOLVO	9-13	41005466	0506927	IVECO	3-4
3173613	0509905	VOLVO	9-20	41005469	0507287	IVECO	3-5
3173615	0508787	VOLVO	9-19	41005472	0506897	IVECO	3-4
3173759	0909379	VOLVO	9-13	41005475	0507293	IVECO	3-5
3193731	0288993	RENAULT V.I.	7-11	41006093	0507293	IVECO	3-5
3193731	0288993	VOLVO	9-10	41009661	0807358	IVECO	3-16
3198234	0509358	VOLVO	9-1	41009665	0807211	IVECO	3-14
3198276	0509916	VOLVO	9-3	41009961	0807225	IVECO	3-14
345124	0506888	SCANIA	8-2	41011006	0807295	IVECO	3-15
3503307135	0196424	MERCEDES	5-11	41011008	0807579	IVECO	3-18
352637	0506829	SCANIA	8-2	41011470	0507287	IVECO	3-5
352645	0186758	SCANIA	8-5	41016958	0506897	IVECO	3-4
352646	0186758	SCANIA	8-5	41016961	0507287	IVECO	3-5
3753220423	0508968	MERCEDES	5-21	41016964	0506927	IVECO	3-4
3754600005	0507887	MERCEDES	5-7	41017269	0507287	IVECO	3-5
3754600405	0507789	MERCEDES	5-7	41017272	0506927	IVECO	3-4
3754601505	0507911	MERCEDES	5-8	41028269	0507904	IVECO	3-7
3754601605	0507587	MERCEDES	5-1	41028598	0807211	IVECO	3-14
382774	0507188	SCANIA	8-3	41028599	0807296	IVECO	3-15
386930	0187228	DAF	2-14	41032608	0507366	IVECO	3-2
3874600705	0506962	MERCEDES	5-5	41032826	0507207	IVECO	3-5
3874601405	0506962	MERCEDES	5-5	41033237	0507366	IVECO	3-2
3874603205	0506962	MERCEDES	5-5	41033731	0807226	IVECO	3-14
3874603305	0506962	MERCEDES	5-5	41034479	0807211	IVECO	3-14
390784	0506913	SCANIA	8-2	41035951	0807358	IVECO	3-16
3913300603	0507610	MERCEDES	5-2	41036943	0506847	IVECO	3-1
3913300803	0507610	MERCEDES	5-2	41036944	0506932	IVECO	3-1
3913301003	0507610	MERCEDES	5-2	41042050	0807211	IVECO	3-14
3913301203	0507610	MERCEDES	5-2	41042092	0807296	IVECO	3-15
3944046	0508786	VOLVO	9-19	41042093	0807299	IVECO	3-16
395009	0196598	SCANIA	8-5	41042730	0506932	IVECO	3-1
395010	0186598	SCANIA	8-5	41042919	0506931	IVECO	3-4
3953500006	0807611	MERCEDES	5-14	41042938	0506847	IVECO	3-1
3962343	0507124	VOLVO	9-1	41203863	0281786	IVECO	3-28
3985570	0509896	VOLVO	9-2	41203864	0291786	IVECO	3-28
3986433	0507123	VOLVO	9-19	41215165	0507370	IVECO	3-6
3986450	0507124	VOLVO	9-1	41218021	0807363	IVECO	3-17
3986452	0509897	VOLVO	9-7	41218482	0181785	IVECO	3-28

RIF. ORIG O.E. NUMBER	RIF. OCAP REF. OCAP	MARCA	PAG.	RIF. ORIG O.E. NUMBER	RIF. OCAP REF. OCAP	MARCA	PAG.
41218620	0807372	IVECO	3-17	4274600005	0507611	MERCEDES	5-5
41218621	0807372	IVECO	3-17	4274600105	0507611	MERCEDES	5-5
41226580	0507370	IVECO	3-6	4274600305	0507611	MERCEDES	5-5
41272428	0809448	IVECO	3-18	4274600405	0507611	MERCEDES	5-5
41272429	0807358	IVECO	3-16	4579231	0186614	IVECO	3-9
41272706	0807373	IVECO	3-17	4579232	0196614	IVECO	3-9
41272707	0807373	IVECO	3-17	468285	0196598	SCANIA	8-5
41296730	0807374	IVECO	3-17	468286	0186598	SCANIA	8-5
41296731	0807374	IVECO	3-17	4688941	0186608	IVECO	3-8
41298449	0507904	IVECO	3-7	4688948	0186599	IVECO	3-8
42001325	0506855	IVECO	3-3	4688949	0196599	IVECO	3-8
42001326	0506855	IVECO	3-3	4714134	0807207	IVECO	3-13
42003432	0506847	IVECO	3-1	4741171	0507165	IVECO	3-27
42041107	0807579	IVECO	3-18	4747960	0506840	IVECO	3-3
42041328	0291786	IVECO	3-28	4747961	0506840	IVECO	3-3
42042912	0181785	IVECO	3-28	4802443	0186598	IVECO	3-8
42065332	0807295	IVECO	3-15	4802444	0196598	IVECO	3-8
42079850	0291786	IVECO	3-28	4833820	0186424	IVECO	3-8
42079852	0291786	IVECO	3-28	4833821	0196424	IVECO	3-8
42086458	0506855	IVECO	3-3	4833822	0186598	IVECO	3-8
42087842	0506840	IVECO	3-3	4833823	0196598	IVECO	3-8
42115532	0507314	IVECO	3-5	4833825	0186613	IVECO	3-9
42117267	0506955	IVECO	3-4	4833826	0196613	IVECO	3-9
42118693	0506955	IVECO	3-4	4833827	0186424	IVECO	3-8
42118694	0507314	IVECO	3-5	4833828	0196424	IVECO	3-8
42118781	0506955	IVECO	3-4	4833829	0186598	IVECO	3-8
42125057	0807209	IVECO	3-13	4833830	0196598	IVECO	3-8
4244600305	0507611	MERCEDES	5-5	48510-F3900	0509411	NISSAN	6-2
42483386	0186598	IVECO	3-8	48510-F3901	0509411	NISSAN	6-2
42484886	0186613	IVECO	3-9	48510-LA21D	0509411	NISSAN	6-2
42484887	0196613	IVECO	3-9	485109X100	0506590	NISSAN	6-2
42487165	0186612	IVECO	3-9	485109X101	0506590	NISSAN	6-2
42489395	0196598	IVECO	3-8	48510D8600	0506590	NISSAN	6-2
42489574	0196598	IVECO	3-8	48510F3900	0509411	NISSAN	6-2
42493431	0907330	IVECO	3-15	48510F3901	0509411	NISSAN	6-2
42493781	0186424	IVECO	3-8	48510LA20A	0506590	NISSAN	6-2
42495718	0186424	IVECO	3-8	48510LA21D	0509411	NISSAN	6-2
42530316	0287320	IVECO	3-10	485139X200	0186592	NISSAN	6-3
42530447	0289923	IVECO	3-11	485139X201	0196592	NISSAN	6-3
42532977	0607552	IVECO	3-12	485279X62A	0186592	NISSAN	6-3
42533073	0287361	IVECO	3-10	4854871	0506953	IVECO	3-1
42533101	0287360	IVECO	3-10	4854874	0506952	IVECO	3-4
42533102	0287906	IVECO	3-10	486479X62A	0196592	NISSAN	6-3
42534911	0287552	IVECO	3-10	50 01 852 452	0187723	RENAULT V.I.	7-10
42535046	0907304	IVECO	3-18	50 01 858 763	0187723	RENAULT V.I.	7-10
42537936	0186758	IVECO	3-9	5000212483	0186424	RENAULT V.I.	7-9
42538047	0287320	IVECO	3-10	5000240688	0186758	RENAULT V.I.	7-9
42538048	0289923	IVECO	3-11	5000242475	0186758	RENAULT V.I.	7-9
42538384	0188994	IVECO	3-10	5000242478	0196598	RENAULT V.I.	7-9
42551289	0787250	IVECO	3-23	5000242479	0186758	RENAULT V.I.	7-9
42551290	0797250	IVECO	3-23	5000242485	0186758	RENAULT V.I.	7-9
42551296	0797249	IVECO	3-23	5000242486	0196598	RENAULT V.I.	7-9
42551297	0787249	IVECO	3-22	5000253852	0186598	RENAULT V.I.	7-9
42556991	0287552	IVECO	3-10	5000288360	0186598	RENAULT V.I.	7-9
42569562	0289426	IVECO	3-11	5000288361	0196598	RENAULT V.I.	7-9
42569563	0289425	IVECO	3-11	5000295214	0186424	RENAULT V.I.	7-9
42569566	0609422	IVECO	3-12	5000295215	0196424	RENAULT V.I.	7-9

RIF. ORIG O.E. NUMBER	RIF. OCAP REF. OCAP	MARCA	PAG.	RIF. ORIG O.E. NUMBER	RIF. OCAP REF. OCAP	MARCA	PAG.
5000352082	0506690	RENAULT V.I.	7-5	500324282	0507859	IVECO	3-6
5000446681	0506699	RENAULT V.I.	7-1	500334486	0787250	IVECO	3-23
5000450713	0587990	RENAULT V.I.	7-16	500334487	0797250	IVECO	3-23
5000450714	0597990	RENAULT V.I.	7-16	500334713	0407249	IVECO	3-23
5000453600	0508728	RENAULT V.I.	7-7	500334714	0407249	IVECO	3-23
5000541230	0506690	RENAULT V.I.	7-5	500334716	0407250	IVECO	3-23
5000590236	0186598	RENAULT V.I.	7-9	500334717	0407250	IVECO	3-23
5000613598	0506939	RENAULT V.I.	7-1	500337201	0286616	IVECO	3-25
5000613837	0506697	RENAULT V.I.	7-1	500340451	0807299	IVECO	3-16
5000750976	0807252	RENAULT V.I.	7-12	500340452	0807292	IVECO	3-15
5000783574	0807252	RENAULT V.I.	7-12	500344887	0407249	IVECO	3-23
5000786902	0506695	RENAULT V.I.	7-1	500344888	0407249	IVECO	3-23
5000792132	0287291	RENAULT V.I.	7-10	500379801	0407249	IVECO	3-23
5000804824	0186598	RENAULT V.I.	7-9	500379802	0407249	IVECO	3-23
5000807536	0187228	RENAULT V.I.	7-17	500383975	0587871	IVECO	3-27
5000812483	0186424	RENAULT V.I.	7-9	500383976	0597871	IVECO	3-27
5000819413	0907595	RENAULT V.I.	7-12	500397738	0507369	IVECO	3-6
5000823265	0196598	RENAULT V.I.	7-9	5010037418	0506686	RENAULT V.I.	7-5
5000823987	0186613	RENAULT V.I.	7-9	5010060764	0506679	RENAULT V.I.	7-4
5000858773	0186598	RENAULT V.I.	7-9	5010064641	0807252	RENAULT V.I.	7-12
5000858774	0196598	RENAULT V.I.	7-9	5010094838	0807252	RENAULT V.I.	7-12
5001014345	0907252	RENAULT V.I.	7-12	5010094941	0807252	RENAULT V.I.	7-12
5001823718	0287320	RENAULT V.I.	7-10	5010098467	0507849	RENAULT V.I.	7-1
5001830480	0288930	RENAULT V.I.	7-11	5010130344	0506688	RENAULT V.I.	7-5
5001831473	0186424	RENAULT V.I.	7-9	5010130393	0506683	RENAULT V.I.	7-4
5001832579	0196599	RENAULT V.I.	7-10	5010130394	0508728	RENAULT V.I.	7-7
5001832581	0196598	RENAULT V.I.	7-9	5010145077	0506695	RENAULT V.I.	7-1
5001832582	0186424	RENAULT V.I.	7-9	5010145584	0507849	RENAULT V.I.	7-1
5001834533	0196424	RENAULT V.I.	7-9	5010229242	0506687	RENAULT V.I.	7-5
5001836297	0196598	RENAULT V.I.	7-9	5010238594	0597991	RENAULT V.I.	7-16
5001836298	0186598	RENAULT V.I.	7-9	5010253255	0597991	RENAULT V.I.	7-16
5001842337	0907304	RENAULT V.I.	7-14	5010253256	0587991	RENAULT V.I.	7-16
5001845430	0288930	RENAULT V.I.	7-11	5010291903	0507865	RENAULT V.I.	7-2
5001849879	0287361	RENAULT V.I.	7-11	5010294287	0506681	RENAULT V.I.	7-4
5001849880	0287360	RENAULT V.I.	7-11	5010294288	0506684	RENAULT V.I.	7-4
5001850530	0807252	RENAULT V.I.	7-12	5010294289	0506685	RENAULT V.I.	7-4
5001850549	0186424	RENAULT V.I.	7-9	5010294502	0506682	RENAULT V.I.	7-4
5001850550	0196424	RENAULT V.I.	7-9	5010294707	0507861	RENAULT V.I.	7-5
5001852263	0196424	RENAULT V.I.	7-9	5010294720	0507854	RENAULT V.I.	7-5
5001852452	0187723	RENAULT V.I.	7-10	5010305365	0509463	RENAULT V.I.	7-7
5001858759	0196598	RENAULT V.I.	7-9	5010305367	0507863	RENAULT V.I.	7-6
5001858760	0186598	RENAULT V.I.	7-9	5010383203	0508722	RENAULT V.I.	7-6
5001858763	0187723	RENAULT V.I.	7-10	5010383529	0507988	RENAULT V.I.	7-6
5001859984	0196424	RENAULT V.I.	7-9	5010395796	0507864	RENAULT V.I.	7-6
5001859985	0186424	RENAULT V.I.	7-9	5010439021	0507858	RENAULT V.I.	7-2
5001860769	0197884	RENAULT V.I.	7-10	5010439022	0507856	RENAULT V.I.	7-2
5001860770	0187884	RENAULT V.I.	7-10	5010439023	0507865	RENAULT V.I.	7-2
5001866165	0187903	RENAULT V.I.	7-10	5010439631	0507849	RENAULT V.I.	7-1
5001867774	0187903	RENAULT V.I.	7-10	5010488084	0509439	RENAULT V.I.	7-7
5001868363	0508736	RENAULT V.I.	7-2	5010488097	0507988	RENAULT V.I.	7-6
5001868366	0509911	RENAULT V.I.	7-3	5010488164	0507861	RENAULT V.I.	7-5
5001868374	0508721	RENAULT V.I.	7-6	5010488167	0507863	RENAULT V.I.	7-6
5001868383	0509412	RENAULT V.I.	7-7	5010488464	0507884	RENAULT V.I.	7-6
5001868384	0508723	RENAULT V.I.	7-6	5010488639	0509439	RENAULT V.I.	7-7
5001868385	0509460	RENAULT V.I.	7-7	5010488759	0509439	RENAULT V.I.	7-7
500307556	0506950	IVECO	3-1	5010488836	0508722	RENAULT V.I.	7-6
500310933	0280517	IVECO	3-25	5010557243	0506679	RENAULT V.I.	7-4

RIF. ORIG O.E. NUMBER	RIF. OCAP REF. OCAP	MARCA	PAG.	RIF. ORIG O.E. NUMBER	RIF. OCAP REF. OCAP	MARCA	PAG.
5010557341	0509439	RENAULT V.I.	7-7	607998	0196424	DAF	2-7
5010557523	0508722	RENAULT V.I.	7-6	607999	0186424	DAF	2-6
5010566049	0507864	RENAULT V.I.	7-6	61595957 *	0187158	IVECO	3-9
5010566059	0507855	RENAULT V.I.	7-1	6194602505	0506578	MERCEDES	5-4
5010566062	0507865	RENAULT V.I.	7-2	6194602905	0506578	MERCEDES	5-4
5010566063	0507858	RENAULT V.I.	7-2	6194605205	0506578	MERCEDES	5-4
5010566064	0507856	RENAULT V.I.	7-2	6243500006	0807611	MERCEDES	5-14
5010587004	0508736	RENAULT V.I.	7-2	6253300603	0508967	MERCEDES	5-3
5010600822	0508736	RENAULT V.I.	7-2	6253302003	0508967	MERCEDES	5-3
5010630255	0509463	RENAULT V.I.	7-7	6253302703	0508967	MERCEDES	5-3
5010630434	0509435	RENAULT V.I.	7-2	6253303203	0507437	MERCEDES	5-1
5010630617	0506685	RENAULT V.I.	7-4	638862	0907259	SCANIA	8-8
5010630637	0508721	RENAULT V.I.	7-6	639287	0907259	SCANIA	8-8
5010630638	0508721	RENAULT V.I.	7-6	639370	0907528	SCANIA	8-7
5010630812	0509460	RENAULT V.I.	7-7	6474600005	0506962	MERCEDES	5-5
5010630813	0509460	RENAULT V.I.	7-7	6474600105	0506962	MERCEDES	5-5
5010630820	0509412	RENAULT V.I.	7-7	6593501106	0807611	MERCEDES	5-14
5010630821	0509412	RENAULT V.I.	7-7	6593503406	0807611	MERCEDES	5-14
5010630822	0508723	RENAULT V.I.	7-6	6674601505	0507905	MERCEDES	5-7
5010630823	0508723	RENAULT V.I.	7-6	6674601705	0507905	MERCEDES	5-7
5010630980	0508998	RENAULT V.I.	7-7	67303	0296428	DAF	2-8
5010832582	0186598	RENAULT V.I.	7-9	6734600605	0506583	MERCEDES	5-4
5010832583	0196598	RENAULT V.I.	7-9	67389	0286428	DAF	2-7
504034521	0507866	IVECO	3-7	6754601205	0506581	MERCEDES	5-4
504039506	1215953	IVECO	3-21	6754601805	0506581	MERCEDES	5-4
504039506 *	0903144	IVECO	3-19	6754602205	0506576	MERCEDES	5-4
504049893	0507368	IVECO	3-6	6754602405	0506581	MERCEDES	5-4
504064007	0807296	IVECO	3-15	6754603005	0506581	MERCEDES	5-4
504144266	0509421	IVECO	3-2	6764601105	0506577	MERCEDES	5-4
504212584	0407893	IVECO	3-25	6764601905	0507639	MERCEDES	5-6
504212586	0407893	IVECO	3-25	6764602105	0507639	MERCEDES	5-6
525443	0506430	DAF	2-3	6764603105	0507794	MERCEDES	5-7
542477	0187228	DAF	2-14	6777855	0507116	VOLVO	9-5
550800	0907591	SCANIA	8-7	6791948	0507116	VOLVO	9-5
550806	0907528	SCANIA	8-7	6851490000	0197467	MERCEDES	5-12
550808	0907528	SCANIA	8-7	6862225	0507109	VOLVO	9-1
55175540	0287238	IVECO	3-10	6884001	0196959	VOLVO	9-8
554765	0506430	DAF	2-3	6884002	0186959	VOLVO	9-8
5801282537	0507365	IVECO	3-5	688450	0186598	DAF	2-6
5801282538	0507365	IVECO	3-5	6885513	0907534	VOLVO	9-17
5801304684	0807295	IVECO	3-15	6889478	0196959	VOLVO	9-8
5801378064	0407894	IVECO	3-25	6889479	0186959	VOLVO	9-8
5801384823	0807363	IVECO	3-17	6889483	0296964	VOLVO	9-10
5801564274	0909422	IVECO	3-20	6889484	0286964	VOLVO	9-10
5801564276	0909422	IVECO	3-20	696205	0196598	DAF	2-6
5801564281	0909422	IVECO	3-20	696225	0196598	DAF	2-6
5801564293	0709422	IVECO	3-22	696226	0186758	DAF	2-6
5801564293 *	0409422	IVECO	3-22	698609	0186424	DAF	2-6
5801564316	0709423	IVECO	3-22	7167757	0186608	IVECO	3-8
5801564316 *	0409423	IVECO	3-22	7403193731	0288993	RENAULT V.I.	7-11
5801645286	0507368	IVECO	3-6	7403193731	0288993	VOLVO	9-10
5801692437	0509421	IVECO	3-2	7420448089	0809443	RENAULT V.I.	7-13
607053	0196598	DAF	2-6	7420448089	0809443	VOLVO	9-14
607073	0186758	DAF	2-6	7420547286	0907919	RENAULT V.I.	7-13
607451	0186613	DAF	2-6	7420581086	0509914	RENAULT V.I.	7-3
607452	0196613	DAF	2-6	7420702095	0909994	RENAULT V.I.	7-13
607981	0186598	DAF	2-6	7420702096	0907359	RENAULT V.I.	7-14

RIF. ORIG O.E. NUMBER	RIF. OCAP REF. OCAP	MARCA	PAG.	RIF. ORIG O.E. NUMBER	RIF. OCAP REF. OCAP	MARCA	PAG.
7420741703	0807913	RENAULT V.I.	7-13	81432206129	0807559	MAN	4-8
7420800194	0509374	RENAULT V.I.	7-16	81432206132	0907258	DAF	2-10
7420829503	0807762	RENAULT V.I.	7-12	81432206132	0907258	MAN	4-8
7420840815	0907763	RENAULT V.I.	7-12	81432206140	0807824	MAN	4-10
7420840820	0907762	RENAULT V.I.	7-12	81432206161	0807821	MAN	4-10
7420850454	0509433	RENAULT V.I.	7-16	81432206174	0807807	MAN	4-9
7420937674	0188994	RENAULT V.I.	7-10	81432206190	0807821	MAN	4-10
7421021395	0508998	RENAULT V.I.	7-7	81432206196	0807906	MAN	4-13
7421051052	0808738	RENAULT V.I.	7-13	81432206221	0807840	MAN	4-11
7421192770	0509473	RENAULT V.I.	7-3	81432206229	0807407	MAN	4-8
7421295227	0807762	RENAULT V.I.	7-12	81432206232	0807906	MAN	4-13
7421431678	0289456	RENAULT V.I.	7-11	81432206233	0807906	MAN	4-13
7421446333	0507123	RENAULT V.I.	7-16	81432206236	0807407	MAN	4-8
7421560825	0508721	RENAULT V.I.	7-6	81432206244	0907528	MAN	4-9
7421560838	0509471	RENAULT V.I.	7-8	81432206247	0807820	MAN	4-10
7421560848	0509467	RENAULT V.I.	7-8	81432206250	0907259	MAN	4-9
7421560865	0509412	RENAULT V.I.	7-7	81432206260	0807817	MAN	4-9
7421560882	0508723	RENAULT V.I.	7-6	81432206267	0807407	MAN	4-8
7421560892	0509460	RENAULT V.I.	7-7	81432206268	0807894	MAN	4-12
7421560957	0508736	RENAULT V.I.	7-2	81432206270	0807894	MAN	4-12
7421698605	0509475	RENAULT V.I.	7-8	81432206271	0809420	MAN	4-13
7421698607	0509462	RENAULT V.I.	7-7	81432206272	0807407	MAN	4-8
7422159755	0509473	RENAULT V.I.	7-3	81432206282	0809420	MAN	4-13
7422159764	0509468	RENAULT V.I.	7-3	81432206283	0807817	MAN	4-9
7422163226	0509412	RENAULT V.I.	7-7	81432206285	0909992	MAN	4-13
7422163231	0509466	RENAULT V.I.	7-8	81432206304	0807407	MAN	4-8
7422163636	0509440	RENAULT V.I.	7-2	81432206305	0807407	MAN	4-8
7422325247	0507123	RENAULT V.I.	7-16	81432206314	0809420	MAN	4-13
7422380814	0509475	RENAULT V.I.	7-8	81432206322	0907820	MAN	4-10
7422482969	0507864	RENAULT V.I.	7-6	81432206327	0809420	MAN	4-13
7422526504	0509462	RENAULT V.I.	7-7	81432206341	0807820	MAN	4-10
7482292079	0508998	RENAULT V.I.	7-7	81432206342	0807820	MAN	4-10
7485104224	0907528	RENAULT V.I.	7-14	81432206380	0807407	MAN	4-8
7485114029	0287291	RENAULT V.I.	7-10	81432206382	0807407	MAN	4-8
7485114922	0508728	RENAULT V.I.	7-7	81432206401	0807407	MAN	4-8
7485114936	0506683	RENAULT V.I.	7-4	81432209092	0807811	MAN	4-9
7820249212	0606927	IVECO	3-12	81432209140	0807824	MAN	4-10
7981909	0187228	IVECO	3-28	81432209236	0807407	MAN	4-8
8122752	0186758	IVECO	3-9	81432209267	0807407	MAN	4-8
8122754	0186424	IVECO	3-8	81432209272	0807407	MAN	4-8
8122755	0196424	IVECO	3-8	81432209297	0807894	MAN	4-12
8123394	0196613	IVECO	3-9	81432306051	0907528	MAN	4-9
8131582	0506931	IVECO	3-4	81432306061	0907327	MAN	4-15
8132397	0506931	IVECO	3-4	81432306068	0907528	MAN	4-9
8135446	0506897	IVECO	3-4	81432306099	0907529	MAN	4-15
8135492	0507287	IVECO	3-5	81432701601	0809988	MAN	4-14
8136061	0506927	IVECO	3-4	81432706034	0807533	MAN	4-8
8137027	0807358	IVECO	3-16	81432706054	0807533	MAN	4-8
81432206055	0907259	MAN	4-9	81432706064	0907528	MAN	4-9
81432206067	0807811	MAN	4-9	81432706074	0807533	MAN	4-8
81432206073	0907259	MAN	4-9	81432706076	0807533	MAN	4-8
81432206090	0807811	MAN	4-9	81432706078	0807533	MAN	4-8
81432206092	0807811	MAN	4-9	81432706079	0907529	MAN	4-15
81432206107	0907259	MAN	4-9	81432706080	0907525	MAN	4-15
81432206108	0907258	DAF	2-10	81432706082	0807533	MAN	4-8
81432206108	0907258	MAN	4-8	81432706087	0807839	MAN	4-11
81432206120	0807811	MAN	4-9	81432706088	0807839	MAN	4-11

RIF. ORIG O.E. NUMBER	RIF. OCAP REF. OCAP	MARCA	PAG.	RIF. ORIG O.E. NUMBER	RIF. OCAP REF. OCAP	MARCA	PAG.
81432706091	0907327	MAN	4-15	81466116134	0507408	MAN	4-3
81432706094	0807839	MAN	4-11	81466116135	0507408	MAN	4-3
81432706095	0807839	MAN	4-11	81466116137	0507408	MAN	4-3
81432706096	0807840	MAN	4-11	81466116142	0509982	MAN	4-5
81432706097	0807842	MAN	4-12	81466116146	0509415	MAN	4-5
81432706105	0907907	MAN	4-11	81466116147	0509415	MAN	4-5
81432706110	0907774	IVECO	3-17	81466116148	0509415	MAN	4-5
81432706110	0907774	MAN	4-11	81466116152	0509982	MAN	4-5
81432706113	0807842	MAN	4-12	81466116161	0509982	MAN	4-5
81432706114	0807840	MAN	4-11	81466116162	0509982	MAN	4-5
81432706116	0807841	MAN	4-12	81466116163	0509982	MAN	4-5
81432706117	0807907	MAN	4-13	81466116197	0507917	MAN	4-4
81432706118	0907840	MAN	4-11	81466116198	0507917	MAN	4-4
81432706121	0807840	MAN	4-11	81466116199	0507408	MAN	4-3
81432706122	0907683	MAN	4-16	81466116200	0507408	MAN	4-3
81432706123	0907840	MAN	4-11	81466116204	0509415	MAN	4-5
81432706124	0907907	MAN	4-11	81466116205	0507917	MAN	4-4
81432706126	0907840	MAN	4-11	81466116206	0507408	MAN	4-3
81432706135	0807842	MAN	4-12	81467106112	0507807	MAN	4-1
81432706137	0807839	MAN	4-11	81467106163	0507807	MAN	4-1
81432706145	0809988	MAN	4-14	81467106165	0507807	MAN	4-1
81432706146	0809988	MAN	4-14	81467106167	0507817	MAN	4-1
81432706147	0809988	MAN	4-14	81467106198	0507807	MAN	4-1
81432706150	0807839	MAN	4-11	81467106353	0507807	MAN	4-1
81432706151	0807841	MAN	4-12	81467106354	0507807	MAN	4-1
81432706152	0807907	MAN	4-13	81467106361	0507807	MAN	4-1
81432706160	0807842	MAN	4-12	81467106785	0507843	MAN	4-1
81432706161	0807842	MAN	4-12	81467106830	0507817	MAN	4-1
81466106374	0507955	MAN	4-5	81467106846	0507843	MAN	4-1
81466106579	0507848	MAN	4-1	81467106865	0507841	MAN	4-1
81466106580	0507848	MAN	4-1	81467106866	0507841	MAN	4-1
81466106583	0507848	MAN	4-1	81467106932	0507843	MAN	4-1
81466106624	0507848	MAN	4-1	81467106933	0507843	MAN	4-1
81466106640	0507848	MAN	4-1	81467106934	0507843	MAN	4-1
81466106692	0507815	MAN	4-4	81467116711	0507843	MAN	4-1
81466106693	0507815	MAN	4-4	81467116717	0507841	MAN	4-1
81466106695	0507815	MAN	4-4	81467116720	0507848	MAN	4-1
81466106721	0506443	MAN	4-3	81467116725	0507807	MAN	4-1
81466106753	0507839	MAN	4-4	81467116728	0507841	MAN	4-1
81466106754	0507839	MAN	4-4	81467116736	0507817	MAN	4-1
81466106779	0507822	MAN	4-4	81467116773	0507915	MAN	4-2
81466106780	0507822	MAN	4-4	81467116803	0507814	MAN	4-1
81466106782	0507822	MAN	4-4	81467116805	0507814	MAN	4-1
81466106790	0507820	MAN	4-4	81467116820	0507807	MAN	4-1
81466106791	0507820	MAN	4-4	81467116859	0507915	MAN	4-2
81466106813	0509415	MAN	4-5	81467116860	0507915	MAN	4-2
81466116003	0507409	MAN	4-3	81467116861	0507915	MAN	4-2
81466116004	0507409	MAN	4-3	81467116863	0507915	MAN	4-2
81466116005	0507409	MAN	4-3	81467116893	0507814	MAN	4-1
81466116019	0507955	MAN	4-5	81467116894	0507814	MAN	4-1
81466116087	0507917	MAN	4-4	81467116896	0507814	MAN	4-1
81466116096	0507917	MAN	4-4	81467116921	0507915	MAN	4-2
81466116097	0507917	MAN	4-4	81467116933	0509417	MAN	4-2
81466116104	0507408	MAN	4-3	81467116966	0509417	MAN	4-2
81466116105	0507408	MAN	4-3	8156991	0809386	VOLVO	9-14
81466116132	0507917	MAN	4-4	8158207	0807687	VOLVO	9-11
81466116133	0507917	MAN	4-4	8163773	0506932	IVECO	3-1

RIF. ORIG O.E. NUMBER	RIF. OCAP REF. OCAP	MARCA	PAG.	RIF. ORIG O.E. NUMBER	RIF. OCAP REF. OCAP	MARCA	PAG.
8165309	0507288	IVECO	3-2	85125126	0186959	VOLVO	9-8
8178244	0287291	DAF	2-8	85432206002	0907327	MAN	4-15
8193645	0186613	IVECO	3-9	85466106006	0507839	MAN	4-4
8193646	0196613	IVECO	3-9	85466106019	0507215	MAN	4-3
81953010022	0186758	MAN	4-6	85466106020	0507815	MAN	4-4
81953010077	0186595	MAN	4-6	85466106021	0507533	MAN	4-3
81953010078	0196595	MAN	4-6	85466106031	0507839	MAN	4-4
81953010079	0196613	MAN	4-6	85466106102	0506446	MAN	4-3
81953016018	0289923	MAN	4-7	85466106104	0507839	MAN	4-4
81953016019	0289923	MAN	4-7	85466106119	0507215	MAN	4-3
81953016060	0186613	MAN	4-6	85466106121	0507533	MAN	4-3
81953016063	0297229	MAN	4-17	85466106140	0507533	MAN	4-3
81953016131	0297229	MAN	4-17	85466106150	0507215	MAN	4-3
81953016132	0907533	MAN	4-9	85466106151	0507815	MAN	4-4
81953016133	0907534	MAN	4-9	85466106160	0507812	MAN	4-4
81953016134	0186595	MAN	4-6	85466106162	0509968	MAN	4-5
81953016135	0186613	MAN	4-6	85466106203	0507839	MAN	4-4
81953016139	0196613	MAN	4-6	85466106219	0507215	MAN	4-3
81953016140	0186613	MAN	4-6	85466106221	0507533	MAN	4-3
81953016141	0196595	MAN	4-6	85466106246	0507812	MAN	4-4
81953016142	0186595	MAN	4-6	8558522	0506726	IVECO	3-3
81953016169	0187228	MAN	4-17	8558524	0196612	IVECO	3-9
81953016170	0287229	MAN	4-17	8558527	0186612	IVECO	3-9
81953016171	0297229	MAN	4-17	8558533	0186613	IVECO	3-9
81953016174	0297229	MAN	4-17	8558536	0196613	IVECO	3-9
81953016222	0196613	MAN	4-6	8564248	0506737	IVECO	3-3
81953016249	0186613	MAN	4-6	8564386	0507290	IVECO	3-2
81953016263	0186442	MAN	4-6	8565366	0186608	IVECO	3-8
81953016268	0289923	MAN	4-7	8580735	0286616	IVECO	3-25
81953016270	0187843	MAN	4-6	8582320	0507290	IVECO	3-2
81953016280	0287361	MAN	4-7	8582322	0186613	IVECO	3-9
81953016281	0287360	MAN	4-7	8582332	0186608	IVECO	3-8
81953016286	0188994	MAN	4-7	8582333	0196608	IVECO	3-10
81953016288	0187723	MAN	4-6	8590435	0506887	IVECO	3-3
81953016303	0186595	MAN	4-6	8590443	0506737	IVECO	3-3
81953016304	0196595	MAN	4-6	8590479	0506726	IVECO	3-3
81953016321	0186595	MAN	4-6	8591219	0506737	IVECO	3-3
81953016322	0196595	MAN	4-6	8591222	0506726	IVECO	3-3
81953016328	0186613	MAN	4-6	85.43220.6002	0907407	MAN	4-8
81953016337	0287360	MAN	4-7	9009501	0186614	IVECO	3-9
81953016358	0186613	MAN	4-6	9009503	0196614	IVECO	3-9
81953020041	0907259	MAN	4-9	93161371	0907578	IVECO	3-13
81.95301.6288	0187723	MAN	4-6	93161631	0907297	IVECO	3-14
82165564	0507863	VOLVO	9-5	93161638	0907299	IVECO	3-16
82432706005	0809988	MAN	4-14	93161720	0907304	IVECO	3-18
82432706007	0809988	MAN	4-14	93161958	0907297	IVECO	3-14
82466106080	0507955	MAN	4-5	93161960	0907296	IVECO	3-14
82466106189	0507955	MAN	4-5	93163617	0907927	IVECO	3-20
82466106190	0507955	MAN	4-5	93163828	0186598	IVECO	3-8
82466106191	0507820	MAN	4-4	93163964	0809418	IVECO	3-18
82953016016	0287360	MAN	4-7	93190752	0186598	IVECO	3-8
8483500106	0807669	MERCEDES	5-15	93192361	0907327	IVECO	3-14
85104224	0907528	VOLVO	9-13	93192618	0907304	IVECO	3-18
85112073	0186959	VOLVO	9-8	93192619	0907330	IVECO	3-15
85114144	0507101	VOLVO	9-4	93194626	0186612	IVECO	3-9
85114200	0507113	VOLVO	9-5	93800662	0280515	IVECO	3-10
85115631	0509894	VOLVO	9-2	93802209	0280517	IVECO	3-25

RIF. ORIG O.E. NUMBER	RIF. OCAP REF. OCAP	MARCA	PAG.	RIF. ORIG O.E. NUMBER	RIF. OCAP REF. OCAP	MARCA	PAG.
93802242	0400518	IVECO	3-25	9483502305	0808986	MERCEDES	5-17
93804059	0280515	IVECO	3-10	9483502405	0807669	MERCEDES	5-15
93804060	0280517	IVECO	3-25	9483502505	0808975	MERCEDES	5-16
93807320	0400518	IVECO	3-25	9483502905	0808982	MERCEDES	5-17
93807545	0400518	IVECO	3-25	9483503005	0807774	MERCEDES	5-15
93807640	1215270	IVECO	3-20	9493300203	0507591	MERCEDES	5-1
93807641	1215269	IVECO	3-20	9493300303	0507591	MERCEDES	5-1
93810239	1215271	IVECO	3-20	9493300403	0507604	MERCEDES	5-1
93827647	0287552	IVECO	3-10	9493300503	0507604	MERCEDES	5-1
94038	0506430	DAF	2-3	9493300603	0507603	MERCEDES	5-1
9413300003	0507643	MERCEDES	5-2	9493300703	0507603	MERCEDES	5-1
9413300007	0807636	MERCEDES	5-15	9493300803	0507591	MERCEDES	5-1
9413300103	0507643	MERCEDES	5-2	9493300903	0507591	MERCEDES	5-1
9413300203	0507643	MERCEDES	5-2	9493301003	0507436	MERCEDES	5-1
9413300303	0507643	MERCEDES	5-2	9493301103	0507436	MERCEDES	5-1
9413300503	0507643	MERCEDES	5-2	9493301403	0507604	MERCEDES	5-1
9423300003	0507633	MERCEDES	5-2	9493301503	0507603	MERCEDES	5-1
9423300103	0507633	MERCEDES	5-2	9493301603	0507603	MERCEDES	5-1
9423300203	0507633	MERCEDES	5-2	9493301703	0507436	MERCEDES	5-1
9423300503	0508967	MERCEDES	5-3	9493301903	0507604	MERCEDES	5-1
9423300903	0508967	MERCEDES	5-3	9493302003	0507603	MERCEDES	5-1
9423301103	0507633	MERCEDES	5-2	9493302303	0507604	MERCEDES	5-1
9423301903	0508967	MERCEDES	5-3	9493302403	0507603	MERCEDES	5-1
9423500505	0807599	MERCEDES	5-14	9574600405	0508939	MERCEDES	5-9
9423500805	0807599	MERCEDES	5-14	9574600505	0507972	MERCEDES	5-9
9423501005	0807634	MERCEDES	5-14	9574600705	0507972	MERCEDES	5-9
9423501205	0807599	MERCEDES	5-14	9574600905	0508939	MERCEDES	5-9
9423501505	0807634	MERCEDES	5-14	9603300403	0509442	MERCEDES	5-3
9443301703	0507437	MERCEDES	5-1	9603500906	0809444	MERCEDES	5-18
9443500005	0807634	MERCEDES	5-14	9703300003	0509391	MERCEDES	5-3
9443500305	0807634	MERCEDES	5-14	9704600705	0507613	MERCEDES	5-5
9443500505	0807774	MERCEDES	5-15	9704600905	0507613	MERCEDES	5-5
9453300003	0507916	MERCEDES	5-2	9724601405	0507439	MERCEDES	5-5
9453300007	0807635	MERCEDES	5-15	9724601605	0507439	MERCEDES	5-5
9453300103	0507916	MERCEDES	5-2	9724601805	0507827	MERCEDES	5-7
9453300203	0507651	MERCEDES	5-2	9724602005	0507827	MERCEDES	5-7
9453300303	0507651	MERCEDES	5-2	9743500005	0808987	MERCEDES	5-17
9453300403	0507916	MERCEDES	5-2	9743500405	0808987	MERCEDES	5-17
9453300503	0507651	MERCEDES	5-2	9743500505	0808987	MERCEDES	5-17
9453300603	0507916	MERCEDES	5-2	9744601005	0507887	MERCEDES	5-7
9453500105	0808975	MERCEDES	5-16	9744601105	0507963	MERCEDES	5-8
9473500005	0807669	MERCEDES	5-15	9744601205	0507887	MERCEDES	5-7
9473500105	0807634	MERCEDES	5-14	9744601305	0507963	MERCEDES	5-8
9473500605	0807669	MERCEDES	5-15	9753300203	0507975	MERCEDES	5-2
9473500705	0807634	MERCEDES	5-14	9753300303	0507975	MERCEDES	5-2
9473500905	0807774	MERCEDES	5-15	9753300803	0507975	MERCEDES	5-2
9473501005	0807634	MERCEDES	5-14	9753302503	0507975	MERCEDES	5-2
9483500006	0807669	MERCEDES	5-15	98402544	0506951	IVECO	3-4
9483500405	0807774	MERCEDES	5-15	98402553	0506950	IVECO	3-1
9483500805	0807669	MERCEDES	5-15	98446354	0506894	IVECO	3-3
9483500905	0808986	MERCEDES	5-17	98449025	0506956	IVECO	3-5
9483501005	0808975	MERCEDES	5-16	98467459	0506951	IVECO	3-4
9483501205	0807669	MERCEDES	5-15	98469650	0506956	IVECO	3-5
9483501305	0807669	MERCEDES	5-15	98470968	0506994	IVECO	3-1
9483501705	0807908	MERCEDES	5-16	98472466	0807358	IVECO	3-16
9483502005	0807669	MERCEDES	5-15	98472468	0807296	IVECO	3-15
9483502205	0807908	MERCEDES	5-16	98472871	0807336	IVECO	3-16

RIF. ORIGINALE - RIF. OCAP - MARCA

CORRISPONDENZE RIFERIMENTI ORIGINALI

Cross Reference Guide - Vergleichenummern List - Liste D'equivalence - Guia De Intercambios

RIF. ORIG O.E. NUMBER	RIF. OCAP REF. OCAP	MARCA	PAG.	RIF. ORIG O.E. NUMBER	RIF. OCAP REF. OCAP	MARCA	PAG.
98473328	0507850	IVECO	3-6				
98493054	0507851	IVECO	3-6				
99458576	0809418	IVECO	3-18				
99463268	0607552	IVECO	3-12				
9983325	0600516	IVECO	3-12				
A0003305248	0186758	MERCEDES	5-12				
A0003406169	0186758	MERCEDES	5-12				
A0003406251	0186758	MERCEDES	5-12				
A0014608948	0187789	MERCEDES	5-13				
ACHF060	0186598	DAF	2-6				
ACHF241	0196424	DAF	2-7				
ACU9239	0197803	DAF	2-7				
ACU9240	0187803	DAF	2-7				
ACU9242	0186613	DAF	2-6				
AFRA635	0197928	DAF	2-7				
AFRA888	0187803	DAF	2-7				

RIF. OCAP REF. OCAP	RIF. ORIG O.E. NUMBER	MARCA	PAG.	RIF. OCAP REF. OCAP	RIF. ORIG O.E. NUMBER	MARCA	PAG.
0181785	41218482	IVECO	3-28	0187916	0014602948	MERCEDES	5-13
0182344	-	RENAULT V.I.	7-9	0187959	0014603848	MERCEDES	5-13
0186168	1604248	DAF	2-6	0188994	1685552	DAF	2-7
0186424	1229944	DAF	2-6	0188994	42538384	IVECO	3-10
0186424	2966688	IVECO	3-8	0188994	81953016286	MAN	4-7
0186424	0003307335	MERCEDES	5-11	0188994	7420937674	RENAULT V.I.	7-10
0186424	5000212483	RENAULT V.I.	7-9	0188994	1358793	SCANIA	8-5
0186442	81953016263	MAN	4-6	0188994	20937674	VOLVO	9-9
0186547	0013300335	MERCEDES	5-11	0189896	21263974	VOLVO	9-9
0186551	0004605748	MERCEDES	5-11	0189914	20581089	VOLVO	9-9
0186592	11200360-0	NISSAN	6-3	0196168	1604247	DAF	2-7
0186595	81953010077	MAN	4-6	0196424	1315447	DAF	2-7
0186598	1149907	DAF	2-6	0196424	2984511	IVECO	3-8
0186598	42483386	IVECO	3-8	0196424	0003406218	MERCEDES	5-11
0186598	0004601048	MERCEDES	5-11	0196424	5000295215	RENAULT V.I.	7-9
0186598	5000253852	RENAULT V.I.	7-9	0196547	-	MERCEDES	5-11
0186598	0283784	SCANIA	8-5	0196592	11200361-0	NISSAN	6-3
0186598	20742127	VOLVO	9-8	0196595	81953010078	MAN	4-6
0186599	4688948	IVECO	3-8	0196598	1228115	DAF	2-6
0186608	4688941	IVECO	3-8	0196598	42489395	IVECO	3-8
0186612	42487165	IVECO	3-9	0196598	0004603448	MERCEDES	5-11
0186612	0003301235	MERCEDES	5-12	0196598	5000242478	RENAULT V.I.	7-9
0186612	1696919	VOLVO	9-8	0196598	1358792	SCANIA	8-5
0186613	0110197	DAF	2-6	0196599	4688949	IVECO	3-8
0186613	2966321	IVECO	3-9	0196599	5001832579	RENAULT V.I.	7-10
0186613	81953016060	MAN	4-6	0196603	4018037	IVECO	3-8
0186613	0003301435	MERCEDES	5-12	0196608	1689605	DAF	2-7
0186613	5000823987	RENAULT V.I.	7-9	0196608	8582333	IVECO	3-10
0186614	4579231	IVECO	3-9	0196612	8558524	IVECO	3-9
0186758	607073	DAF	2-6	0196612	0003301235	MERCEDES	5-12
0186758	042489573	IVECO	3-9	0196613	1373137	DAF	2-6
0186758	81953010022	MAN	4-6	0196613	2969507	IVECO	3-9
0186758	A0003305248	MERCEDES	5-12	0196613	81953010079	MAN	4-6
0186758	5000240688	RENAULT V.I.	7-9	0196614	4579232	IVECO	3-9
0186758	1337367	SCANIA	8-5	0196758	1337366	SCANIA	8-5
0186758	20742127	VOLVO	9-8	0196946	3090728	VOLVO	9-9
0186946	3090472	VOLVO	9-8	0196959	1505758	VOLVO	9-8
0186959	1505759	VOLVO	9-8	0196960	1131744	VOLVO	9-9
0186960	1507826	VOLVO	9-8	0196961	0004606148	MERCEDES	5-13
0187146	0004602648	MERCEDES	5-12	0197146	0014607448	MERCEDES	5-12
0187158	61595957 *	IVECO	3-9	0197467	6851490000	MERCEDES	5-12
0187228	0386930	DAF	2-14	0197803	ACU9239	DAF	2-7
0187228	7981909	IVECO	3-28	0197884	5001860769	RENAULT V.I.	7-10
0187228	81953016169	MAN	4-17	0197928	1401942	DAF	2-7
0187228	5000807536	RENAULT V.I.	7-17	0199914	20710008	VOLVO	9-9
0187467	0004601748	MERCEDES	5-12	0280515	1903652	IVECO	3-10
0187686	3093647	VOLVO	9-9	0280517	500310933	IVECO	3-25
0187723	1149875	DAF	2-6	0281786	41203863	IVECO	3-28
0187723	81953016288	MAN	4-6	0286428	67389	DAF	2-7
0187723	50 01 852 452	RENAULT V.I.	7-10	0286616	500337201	IVECO	3-25
0187723	20894438	VOLVO	9-9	0286964	1131742	VOLVO	9-10
0187789	0014604148	MERCEDES	5-13	0287229	81953016170	MAN	4-17
0187803	ACU9240	DAF	2-7	0287238	55175540	IVECO	3-10
0187843	81953016270	MAN	4-6	0287291	8178244	DAF	2-8
0187884	5001860770	RENAULT V.I.	7-10	0287291	5000792132	RENAULT V.I.	7-10
0187894	1723897	SCANIA	8-5	0287320	42530316	IVECO	3-10
0187903	5001866165	RENAULT V.I.	7-10	0287320	5001823718	RENAULT V.I.	7-10

RIF. OCAP REF. OCAP	RIF. ORIG O.E. NUMBER	MARCA	PAG.	RIF. OCAP REF. OCAP	RIF. ORIG O.E. NUMBER	MARCA	PAG.
0287360	42533101	IVECO	3-10	0506686	5010037418	RENAULT V.I.	7-5
0287360	81953016281	MAN	4-7	0506687	5010229242	RENAULT V.I.	7-5
0287360	5001849880	RENAULT V.I.	7-11	0506688	5010130344	RENAULT V.I.	7-5
0287360	1394444	SCANIA	8-5	0506690	5000352082	RENAULT V.I.	7-5
0287361	42533073	IVECO	3-10	0506695	5000786902	RENAULT V.I.	7-1
0287361	81953016280	MAN	4-7	0506697	5000613837	RENAULT V.I.	7-1
0287361	5001849879	RENAULT V.I.	7-11	0506699	5000446681	RENAULT V.I.	7-1
0287361	1394443	SCANIA	8-5	0506726	8558522	IVECO	3-3
0287503	0273203	DAF	2-8	0506737	8564248	IVECO	3-3
0287552	42534911	IVECO	3-10	0506829	352637	SCANIA	8-2
0287684	0004604948	MERCEDES	5-13	0506840	42087842	IVECO	3-3
0287684	1912759	SCANIA	8-6	0506847	41036943	IVECO	3-1
0287906	42533102	IVECO	3-10	0506855	42001325	IVECO	3-3
0288779	20374698	VOLVO	9-10	0506869	1304571	SCANIA	8-2
0288930	0014601648	MERCEDES	5-13	0506887	8590435	IVECO	3-3
0288930	5001830480	RENAULT V.I.	7-11	0506888	345124	SCANIA	8-2
0288993	3193731	RENAULT V.I.	7-11	0506894	98446354	IVECO	3-3
0288993	3193731	VOLVO	9-10	0506897	41005472	IVECO	3-4
0289425	42569563	IVECO	3-11	0506913	390784	SCANIA	8-2
0289426	42569562	IVECO	3-11	0506916	1308643	SCANIA	8-2
0289455	1394447	SCANIA	8-6	0506918	306981	SCANIA	8-2
0289456	7421431678	RENAULT V.I.	7-11	0506919	1369919	SCANIA	8-3
0289456	21431678	VOLVO	9-10	0506920	1356055	SCANIA	8-3
0289923	42530447	IVECO	3-11	0506927	41005466	IVECO	3-4
0289923	81953016018	MAN	4-7	0506931	41005463	IVECO	3-4
0289923	3090291	VOLVO	9-10	0506932	41005450	IVECO	3-1
0291786	41002119	IVECO	3-28	0506936	1112511	SCANIA	8-3
0296428	67303	DAF	2-8	0506937	1385251	SCANIA	8-1
0296964	1131741	VOLVO	9-10	0506939	5000613598	RENAULT V.I.	7-1
0297229	81953016063	MAN	4-17	0506939	1723896	SCANIA	8-1
0400518	93802242	IVECO	3-25	0506950	500307556	IVECO	3-1
0407249	500334713	IVECO	3-23	0506951	98402544	IVECO	3-4
0407250	500334716	IVECO	3-23	0506952	4854874	IVECO	3-4
0407893	504212584	IVECO	3-25	0506953	4854871	IVECO	3-1
0407894	5801378064	IVECO	3-25	0506955	42117267	IVECO	3-4
0409422	5801564293 *	IVECO	3-22	0506956	98449025	IVECO	3-5
0409423	5801564316 *	IVECO	3-22	0506962	3874600705	MERCEDES	5-5
0506430	0094038	DAF	2-3	0506967	1610338	VOLVO	9-4
0506432	1286343	DAF	2-1	0506994	98470968	IVECO	3-1
0506433	1291060	DAF	2-3	0507100	1592940	VOLVO	9-4
0506443	81466106721	MAN	4-3	0507101	1592939	VOLVO	9-4
0506446	85466106102	MAN	4-3	0507107	1075005	VOLVO	9-4
0506576	6754602205	MERCEDES	5-4	0507108	1691660	VOLVO	9-4
0506577	6764601105	MERCEDES	5-4	0507109	1505855	VOLVO	9-1
0506578	6194602505	MERCEDES	5-4	0507111	1075663	VOLVO	9-4
0506581	6754601205	MERCEDES	5-4	0507112	1075153	VOLVO	9-5
0506583	6734600605	MERCEDES	5-4	0507113	1628636	VOLVO	9-5
0506585	0004607105	MERCEDES	5-4	0507116	20400909	VOLVO	9-5
0506588	11200265-0	NISSAN	6-1	0507120	1075664	VOLVO	9-5
0506590	11200454-0	NISSAN	6-2	0507123	7421446333	RENAULT V.I.	7-16
0506591	11505036-0	NISSAN	6-2	0507123	21446333	VOLVO	9-19
0506679	5010060764	RENAULT V.I.	7-4	0507124	1626637	VOLVO	9-1
0506681	5010294287	RENAULT V.I.	7-4	0507165	4741171	IVECO	3-27
0506682	5010294502	RENAULT V.I.	7-4	0507188	382774	SCANIA	8-3
0506683	5010130393	RENAULT V.I.	7-4	0507207	41032826	IVECO	3-5
0506684	5010294288	RENAULT V.I.	7-4	0507215	85466106019	MAN	4-3
0506685	5010294289	RENAULT V.I.	7-4	0507221	20443062	VOLVO	9-19

RIF. OCAP REF. OCAP	RIF. ORIG O.E. NUMBER	MARCA	PAG.	RIF. OCAP REF. OCAP	RIF. ORIG O.E. NUMBER	MARCA	PAG.
0507287	41005469	IVECO	3-5	0507855	5010566059	RENAULT V.I.	7-1
0507288	8165309	IVECO	3-2	0507856	5010439022	RENAULT V.I.	7-2
0507290	8564386	IVECO	3-2	0507858	5010439021	RENAULT V.I.	7-2
0507293	41005475	IVECO	3-5	0507859	500324282	IVECO	3-6
0507314	42115532	IVECO	3-5	0507861	5010294707	RENAULT V.I.	7-5
0507365	5801282537	IVECO	3-5	0507863	5010305367	RENAULT V.I.	7-6
0507366	41032608	IVECO	3-2	0507863	20709844	VOLVO	9-5
0507368	504049893	IVECO	3-6	0507864	5010395796	RENAULT V.I.	7-6
0507369	500397738	IVECO	3-6	0507865	5010291903	RENAULT V.I.	7-2
0507370	41215165	IVECO	3-6	0507866	504034521	IVECO	3-7
0507408	81466116104	MAN	4-3	0507884	5010488464	RENAULT V.I.	7-6
0507409	81466116003	MAN	4-3	0507887	0034604605	MERCEDES	5-7
0507436	9493301003	MERCEDES	5-1	0507904	41028269	IVECO	3-7
0507437	6253303203	MERCEDES	5-1	0507905	6674601505	MERCEDES	5-7
0507439	9724601405	MERCEDES	5-5	0507911	0014601305	MERCEDES	5-8
0507533	85466106021	MAN	4-3	0507912	0024605205	MERCEDES	5-8
0507587	0014601505	MERCEDES	5-1	0507915	81467116773	MAN	4-2
0507591	9493300203	MERCEDES	5-1	0507916	9453300003	MERCEDES	5-2
0507603	9493300603	MERCEDES	5-1	0507917	81466116087	MAN	4-4
0507604	9493300403	MERCEDES	5-1	0507918	20443061	VOLVO	9-19
0507610	3913300603	MERCEDES	5-2	0507933	1270853	DAF	2-1
0507611	4244600305	MERCEDES	5-5	0507934	0288281	DAF	2-1
0507613	9704600705	MERCEDES	5-5	0507936	1392640	DAF	2-3
0507614	0024609605	MERCEDES	5-5	0507937	1451118	DAF	2-3
0507615	0024604905	MERCEDES	5-5	0507938	1380417	DAF	2-3
0507617	4054600005	MERCEDES	5-6	0507942	1297572	DAF	2-1
0507627	0004609805	MERCEDES	5-6	0507947	1395994	DAF	2-3
0507630	0024604305	MERCEDES	5-6	0507948	1363859	DAF	2-4
0507631	0024604705	MERCEDES	5-6	0507949	1700000	DAF	2-1
0507632	0014609805	MERCEDES	5-6	0507955	81466106374	MAN	4-5
0507633	9423300003	MERCEDES	5-2	0507961	0014601105	MERCEDES	5-8
0507639	6764601905	MERCEDES	5-6	0507962	0024606105	MERCEDES	5-8
0507642	0034601805	MERCEDES	5-7	0507963	0034600705	MERCEDES	5-8
0507643	9413300003	MERCEDES	5-2	0507965	0024605905	MERCEDES	5-8
0507651	9453300203	MERCEDES	5-2	0507967	0004609505	MERCEDES	5-9
0507723	1361413	SCANIA	8-1	0507968	0014600705	MERCEDES	5-9
0507731	1379072	SCANIA	8-3	0507972	9574600505	MERCEDES	5-9
0507766	1343283	SCANIA	8-3	0507975	9753300203	MERCEDES	5-2
0507767	1343266	SCANIA	8-4	0507988	5010383529	RENAULT V.I.	7-6
0507789	0024604505	MERCEDES	5-7	0507999	1343262	SCANIA	8-4
0507794	6764603105	MERCEDES	5-7	0508721	5001868374	RENAULT V.I.	7-6
0507807	81467106112	MAN	4-1	0508722	5010383203	RENAULT V.I.	7-6
0507812	85466106160	MAN	4-4	0508723	5001868384	RENAULT V.I.	7-6
0507814	81467116803	MAN	4-1	0508723	20727843	VOLVO	9-5
0507815	81466106692	MAN	4-4	0508728	5000453600	RENAULT V.I.	7-7
0507817	81467106167	MAN	4-1	0508736	5001868363	RENAULT V.I.	7-2
0507820	81466106790	MAN	4-4	0508736	21560957	VOLVO	9-1
0507822	81466106779	MAN	4-4	0508758	1723896	SCANIA	8-1
0507827	0034605905	MERCEDES	5-7	0508786	20477807	VOLVO	9-19
0507839	81466106753	MAN	4-4	0508787	20443063	VOLVO	9-19
0507841	81467106865	MAN	4-1	0508799	20390745	VOLVO	9-6
0507843	81467106785	MAN	4-1	0508939	9574600405	MERCEDES	5-9
0507848	81466106579	MAN	4-1	0508957	0024608605	MERCEDES	5-9
0507849	5010098467	RENAULT V.I.	7-1	0508967	6253300603	MERCEDES	5-3
0507850	98473328	IVECO	3-6	0508968	0003220323	MERCEDES	5-21
0507851	98493054	IVECO	3-6	0508969	0003220423	MERCEDES	5-21
0507854	5010294720	RENAULT V.I.	7-5	0508998	5010630980	RENAULT V.I.	7-7

RIF. OCAP REF. OCAP	RIF. ORIG O.E. NUMBER	MARCA	PAG.	RIF. OCAP REF. OCAP	RIF. ORIG O.E. NUMBER	MARCA	PAG.
0509357	20392778	VOLVO	9-1	0509905	3173613	VOLVO	9-20
0509358	21260275	VOLVO	9-1	0509911	5001868366	RENAULT V.I.	7-3
0509359	20587731	VOLVO	9-1	0509911	20824578	VOLVO	9-2
0509374	7420800194	RENAULT V.I.	7-16	0509914	7420581086	RENAULT V.I.	7-3
0509391	9703300003	MERCEDES	5-3	0509914	20581086	VOLVO	9-3
0509411	48510-F3900	NISSAN	6-2	0509915	21119064	VOLVO	9-20
0509412	5001868383	RENAULT V.I.	7-7	0509916	21260274	VOLVO	9-3
0509412	20727840	VOLVO	9-6	0509939	1406600	DAF	2-4
0509415	81466106813	MAN	4-5	0509941	1401937	DAF	2-4
0509416	1393383	SCANIA	8-4	0509943	1403898	DAF	2-5
0509417	81467116933	MAN	4-2	0509946	1395993	DAF	2-5
0509421	504144266	IVECO	3-2	0509947	1395995	DAF	2-5
0509433	7420850454	RENAULT V.I.	7-16	0509968	85466106162	MAN	4-5
0509435	5010630434	RENAULT V.I.	7-2	0509982	81466116142	MAN	4-5
0509436	22159757	VOLVO	9-1	0587871	500383975	IVECO	3-27
0509437	21367010	VOLVO	9-2	0587990	5000450713	RENAULT V.I.	7-16
0509438	1732973	DAF	2-1	0587991	5010253256	RENAULT V.I.	7-16
0509439	20818854	RENAULT V.I.	7-7	0597871	500383976	IVECO	3-27
0509439	20818854	VOLVO	9-6	0597990	5000450714	RENAULT V.I.	7-16
0509440	7422163636	RENAULT V.I.	7-2	0597991	5010238594	RENAULT V.I.	7-16
0509441	20393089	VOLVO	9-6	0600516	9983325	IVECO	3-12
0509442	9603300403	MERCEDES	5-3	0602749	2992593	IVECO	3-12
0509449	21119053	VOLVO	9-19	0606927	7820249212	IVECO	3-12
0509450	21197609	VOLVO	9-19	0607552	42532977	IVECO	3-12
0509451	21146253	VOLVO	9-19	0609422	42569566	IVECO	3-12
0509452	21209705	VOLVO	9-20	0709422	5801564293	IVECO	3-22
0509453	3987356	VOLVO	9-20	0709423	5801564316	IVECO	3-22
0509459	1828523	DAF	2-4	0787249	42551297	IVECO	3-22
0509460	5001868385	RENAULT V.I.	7-7	0787250	42551289	IVECO	3-23
0509460	20727850	VOLVO	9-6	0797249	42551296	IVECO	3-23
0509461	0024608805	MERCEDES	5-9	0797250	42551290	IVECO	3-23
0509462	7421698607	RENAULT V.I.	7-7	0807207	4714134	IVECO	3-13
0509462	21543888	VOLVO	9-6	0807209	42125057	IVECO	3-13
0509463	5010305365	RENAULT V.I.	7-7	0807211	41002770	IVECO	3-14
0509463	20818840	VOLVO	9-6	0807221	1080690	VOLVO	9-11
0509464	1373878	DAF	2-4	0807222	1082104	VOLVO	9-11
0509465	22159741	VOLVO	9-7	0807225	41009961	IVECO	3-14
0509466	7422163231	RENAULT V.I.	7-8	0807226	41033731	IVECO	3-14
0509466	22163223	VOLVO	9-7	0807252	5000750976	RENAULT V.I.	7-12
0509467	7421560848	RENAULT V.I.	7-8	0807292	41003268	IVECO	3-15
0509468	7422159764	RENAULT V.I.	7-3	0807295	41011006	IVECO	3-15
0509468	21261985	VOLVO	9-2	0807296	41028599	IVECO	3-15
0509469	1807596	DAF	2-2	0807299	41042093	IVECO	3-16
0509470	0034608605	MERCEDES	5-10	0807336	98472871	IVECO	3-16
0509471	7421560838	RENAULT V.I.	7-8	0807358	41009661	IVECO	3-16
0509472	22159758	VOLVO	9-2	0807363	01902137	IVECO	3-17
0509473	7421192770	RENAULT V.I.	7-3	0807372	41218620	IVECO	3-17
0509473	21192770	VOLVO	9-2	0807373	41272706	IVECO	3-17
0509474	1426101	DAF	2-4	0807374	41296730	IVECO	3-17
0509475	7421698605	RENAULT V.I.	7-8	0807407	81432206229	MAN	4-8
0509475	22380814	VOLVO	9-7	0807454	1326775	SCANIA	8-7
0509879	1343264	SCANIA	8-4	0807489	1361651	DAF	2-9
0509881	1348269	SCANIA	8-4	0807501	0267743	DAF	2-9
0509893	1094219	VOLVO	9-7	0807525	0649819	DAF	2-9
0509894	20399543	VOLVO	9-2	0807533	81432706034	MAN	4-8
0509896	1612254	VOLVO	9-2	0807555	1261101	DAF	2-10
0509897	20375555	VOLVO	9-7	0807559	81432206129	MAN	4-8

RIF. OCAP REF. OCAP	RIF. ORIG O.E. NUMBER	MARCA	PAG.	RIF. OCAP REF. OCAP	RIF. ORIG O.E. NUMBER	MARCA	PAG.
0807579	41011008	IVECO	3-18	0907224	1135080	VOLVO	9-11
0807599	9423500505	MERCEDES	5-14	0907252	5001014345	RENAULT V.I.	7-12
0807611	3953500006	MERCEDES	5-14	0907257	0691704	DAF	2-12
0807634	9423501005	MERCEDES	5-14	0907257	271188	VOLVO	9-16
0807635	9453300007	MERCEDES	5-15	0907258	1271124	DAF	2-10
0807636	9413300007	MERCEDES	5-15	0907258	2980884	IVECO	3-13
0807669	8483500106	MERCEDES	5-15	0907258	81432206108	MAN	4-8
0807687	1581527	VOLVO	9-11	0907259	81432206055	MAN	4-9
0807762	7420829503	RENAULT V.I.	7-12	0907259	1104335	SCANIA	8-8
0807762	1076639	VOLVO	9-12	0907296	1252284	DAF	2-12
0807771	1399180	SCANIA	8-7	0907296	93161960	IVECO	3-14
0807774	9443500505	MERCEDES	5-15	0907296	274070	VOLVO	9-16
0807807	81432206174	MAN	4-9	0907297	1376730	DAF	2-12
0807811	81432206067	MAN	4-9	0907297	93161631	IVECO	3-14
0807817	81432206260	MAN	4-9	0907297	3093469	VOLVO	9-16
0807820	81432206247	MAN	4-10	0907299	93161631	IVECO	3-16
0807821	81432206161	MAN	4-10	0907304	42535046	IVECO	3-18
0807824	81432206140	MAN	4-10	0907304	5001842337	RENAULT V.I.	7-14
0807839	81432706087	MAN	4-11	0907304	274068	VOLVO	9-16
0807840	81432206221	MAN	4-11	0907327	93192361	IVECO	3-14
0807841	81432706116	MAN	4-12	0907327	81432306061	MAN	4-15
0807842	81432706097	MAN	4-12	0907330	42493431	IVECO	3-15
0807894	81432206229	MAN	4-12	0907330	0003500413	MERCEDES	5-14
0807906	81432206196	MAN	4-13	0907359	0513757	DAF	2-9
0807907	81432706117	MAN	4-13	0907359	7420702096	RENAULT V.I.	7-14
0807908	9483501705	MERCEDES	5-16	0907359	20702096	VOLVO	9-11
0807913	7420741703	RENAULT V.I.	7-13	0907407	85432206002	MAN	4-8
0807913	20367004	VOLVO	9-12	0907489	0698724	DAF	2-9
0807927	1294251	DAF	2-10	0907525	0696320	DAF	2-9
0807930	1361652	DAF	2-10	0907525	81432706080	MAN	4-15
0808738	7421051052	RENAULT V.I.	7-13	0907528	0689748	DAF	2-12
0808738	20522934	VOLVO	9-12	0907528	81432206244	MAN	4-9
0808776	1101843	SCANIA	8-7	0907528	7485104224	RENAULT V.I.	7-14
0808975	9453500105	MERCEDES	5-16	0907528	1102506	SCANIA	8-7
0808982	9483502905	MERCEDES	5-17	0907528	271187	VOLVO	9-13
0808986	9483500905	MERCEDES	5-17	0907529	0696321	DAF	2-10
0808987	9743500005	MERCEDES	5-17	0907529	81432306099	MAN	4-15
0809378	20410053	VOLVO	9-13	0907529	274056	VOLVO	9-14
0809381	20491771	VOLVO	9-13	0907533	0005861035	MAN	4-9
0809385	20556491	VOLVO	9-13	0907534	81953016133	MAN	4-9
0809386	1628133	VOLVO	9-14	0907534	273375	VOLVO	9-17
0809418	93163964	IVECO	3-18	0907547	0003502705	MERCEDES	5-15
0809420	81432206271	MAN	4-13	0907578	93161371	IVECO	3-13
0809434	1440028	SCANIA	8-7	0907586	0005861533	IVECO	3-13
0809443	20448089	RENAULT V.I.	7-13	0907591	0003302111	SCANIA	8-7
0809443	20448089	VOLVO	9-14	0907595	0693778	DAF	2-13
0809444	9603500906	MERCEDES	5-18	0907595	5000819413	RENAULT V.I.	7-12
0809445	21196798	VOLVO	9-14	0907599	0003502505	MERCEDES	5-14
0809446	81432206270	MAN	4-13	0907609	0003502205	MERCEDES	5-17
0809447	2141265	DAF	2-11	0907622	0003502105	MERCEDES	5-18
0809448	41272428	IVECO	3-18	0907634	0003502305	MERCEDES	5-14
0809907	3172829	VOLVO	9-14	0907635	0003301411	MERCEDES	5-15
0809909	1094466	VOLVO	9-15	0907683	0696320	DAF	2-13
0809917	20374444	VOLVO	9-15	0907683	81432706080	MAN	4-16
0809988	81432701601	MAN	4-14	0907683	273706	VOLVO	9-11
0903144	504039506 *	IVECO	3-19	0907757	1271124	DAF	2-13
0907222	1598588	VOLVO	9-11	0907757	-	IVECO	3-13

RIF. OCAP REF. OCAP	RIF. ORIG O.E. NUMBER	MARCA	PAG.	RIF. OCAP REF. OCAP	RIF. ORIG O.E. NUMBER	MARCA	PAG.
0907757	81432206108	MAN	4-8				
0907762	7420840820	RENAULT V.I.	7-12				
0907762	3090712	VOLVO	9-12				
0907763	7420840815	RENAULT V.I.	7-12				
0907763	20840815	VOLVO	9-12				
0907774	0003502405	IVECO	3-17				
0907774	81432706110	MAN	4-11				
0907774	0003502405	MERCEDES	5-16				
0907820	81432206322	MAN	4-10				
0907840	81432706118	MAN	4-11				
0907907	81432706105	MAN	4-11				
0907908	0003503605	MERCEDES	5-16				
0907909	0003503705	MERCEDES	5-16				
0907919	7420547286	RENAULT V.I.	7-13				
0907919	20547286	VOLVO	9-12				
0907927	1321936	DAF	2-10				
0907927	93163617	IVECO	3-20				
0907984	0003502005	MERCEDES	5-20				
0908991	0003502305	MERCEDES	5-20				
0909379	1075255	VOLVO	9-13				
0909380	1628107	VOLVO	9-13				
0909422	5801564274	IVECO	3-20				
0909434	1444472	SCANIA	8-7				
0909447	1676776	DAF	2-11				
0909909	3090452	VOLVO	9-13				
0909992	81432206285	MAN	4-13				
0909994	7420702095	RENAULT V.I.	7-13				
0909994	20702095	VOLVO	9-12				
1215269	93807641	IVECO	3-20				
1215270	93807640	IVECO	3-20				
1215271	93810239	IVECO	3-20				
1215953	504039506	IVECO	3-21				

