



Grand Tour 2018-2019

**PAPATYA®**  
DESIGN FURNITURE

**PAPATYA®**

It's a family trait at Hidromekanik Makine Sanayi ve Tic. A.Ş. to produce high qualified and innovative products since 1945. We have started working for indoor and outdoor furniture over 30 years ago under PAPATYA brand name and focused on new materials and technologies by following the latest trends and lifestyles on market in order to keep its "pioneer trademark" position that began as top quality garden furniture. Since its establishment, PAPATYA has been a reference point in furniture market for its experience and success at creating difference in innovative production technologies and design solutions.

The design aspect of our company is based on inventiveness, creativity, quality, functionality, resistance, research and development. Our unique and rich collection includes wide range of chairs, armchairs, bar stools and tables in polycarbonate, polypropylene, metal and wood materials in order to offer various combinations with the most trendy colour options and satisfy the real needs of our customers.

Our company represents today's and tomorrow's furniture vision by responding to the taste and requirements of global market with high qualified, ergonomic, aesthetic as well as easily deliverable and affordable products, developed by our professional and creative design team. Our energy and experience; combined with the creative input from our designers and technological background enable us to move forward in building worldwide recognized and promising future.

**JOY**  
PAGE 06-11

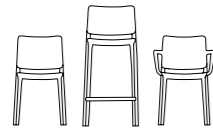

**FAME**  
PAGE 12-17

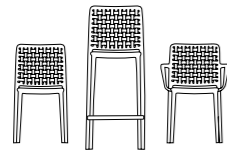

**X'SERA**  
PAGE 18-25



**TRIO / HERA**  
PAGE 26-37

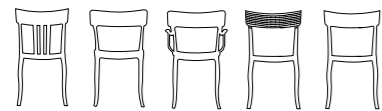

**TORO**  
PAGE 38-41

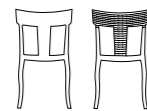

**LUNA**  
PAGE 42-49

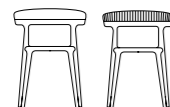

**YUGO**  
PAGE 50-53

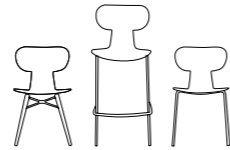

**O'PERA**  
PAGE 54-61

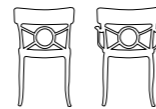

**EGO**  
PAGE 62-73



**OPAL**  
PAGE 74-83



**X-TREME**  
PAGE 84-93



**FLORA**  
PAGE 94-101



**GYZA**  
PAGE 102-107



**CLASS-X**  
PAGE 108-113



**EDEN**  
PAGE 114-121



**MAMBO / COOL**  
PAGE 122-137



**NOSTA**  
PAGE 138-141



**VARIA/YUMMY**  
PAGE 142-151



**TIARA/ICON**  
PAGE 152-159



**VITAL/MARVEL**  
PAGE 160-167

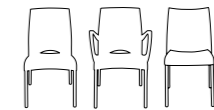

**KAREA**  
PAGE 168-171



**WAVE / ZEN**  
PAGE 172-185



**TABLES**  
PAGE 186-201

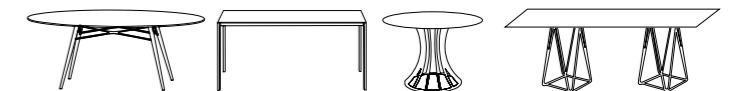

**TABLE BASES**  
PAGE 202-221

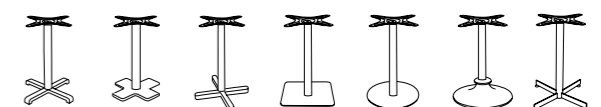

# JOY COLLECTION

---



Joy collection, enjoys all the benefits of simplicity and uniformity in a single form, has fluid lines and a light profile, in silhouette and weight. Delicate details of the glass fiber reinforced injected polypropylene as if it is sculpted from stone, defining a solid and comfortable seating. Offers wide range of usage areas with chair, armchair, upholstered seat and back versions, bar stools in two seating heights. Made for both residential and contract use, indoors and out.



JOY-S | PLUS TABLE BASE



JOY-K  
LOTUS SQUARE TABLE BASE



# FAME COLLECTION

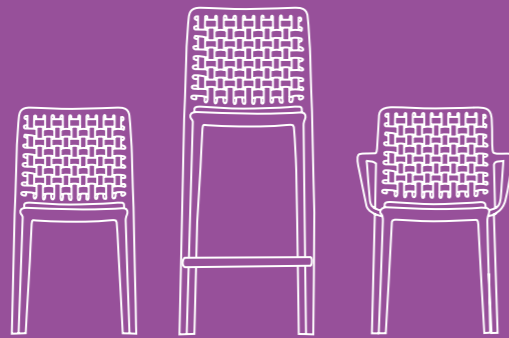

With its singular, simple shape, Fame collection brings efficiency and customization together in unique weave pattern combination. Comfortable, light weight, stackable, formally refined in every detail. Stackable collection made of polypropylene reinforced with glass fiber, suitable for outdoor use. Available in chair, armchair and bar stools in two heights. Perfectly fits in professional areas and suitable for residential purposes.



FAME - K



FAME-K  
FAME-S  
PLUS TABLE BASE





# X'SERA-S

---



Stackable chair, made of gas assisted injection-moulded polypropylene with glass fiber in uv protection. It's practical, youthful and fresh. Comfort and fun come together in a variety of refreshing colours. Its seat and colour options helping you create lovely outdoor and indoor environments in garden, terrace, coffee shops, hotels, restaurants, cafes, swimming pools, events. Perfectly suitable for contract usages.



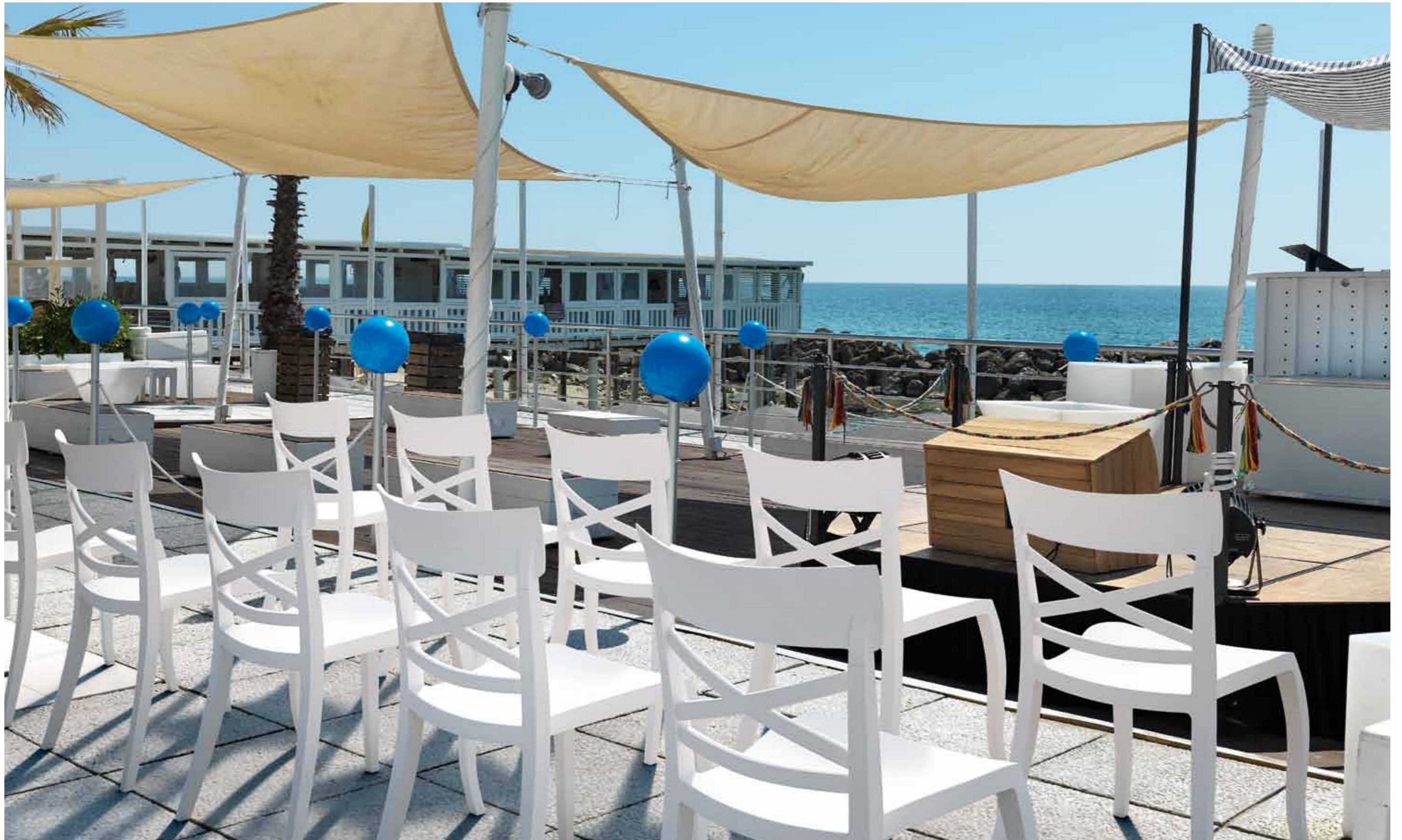





# TRIO-S

---



Traditional and contemporary in a design best describe as timeless. Vertical lines, traditional smooth features a simple design.

A complete range of furniture that furnishes indoor and outdoor spaces with a simplicity. Injected with polypropylene and glass fiber. Stackable. UV protection.





TRIO-S | LOTUS SQUARE TABLE BASE



TRIO-S *Soft* | LOTUS SQUARE TABLE BASE



TRIO-S Soft  
WOX TABLE WITH BEECH LEGS  
LOTUS SQUARE TABLE BASE



# HERA COLLECTION

---



This stackable traditional collection has wide range with four models. Hera-S and Hera-K are both with base in glass fiber reinforced polypropylene and the back in polycarbonate, their traditional construction turns into a contemporary looking lines with combination of the two material and with its fashionable colours make it easily adaptable to every dynamic design environments, also available with rich selection of cushion models.

Hera-SP and Hera-SP Rattan brings new approaches, offers plenty of combinations to Hera Collection. Featuring architectural inspiration and minimalist design, is now available with a polypropylene back options in different shapes and colours, thereby emphasising its richness of the usage in the environments by adding an extra value to it's existing serie as pure garden chair. Anti UV Stabilized. Suitable for indoor and outdoor use.



HERA-K





# TORO COLLECTION

---

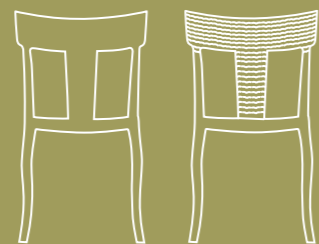

Collection for indoor and outdoor use. Injected with polypropylene and glass fiber, it comes in two different back options with PP smooth surface and Rattan back. Collection brings elegant and practical details that offers refined details and great flexibility. It is ideal for both residential and contract markets, and are available in a wide range of colours with optional padded cushions. Stackable. UV protection.



TORO-SRATTAN | HERA-SPRATTAN

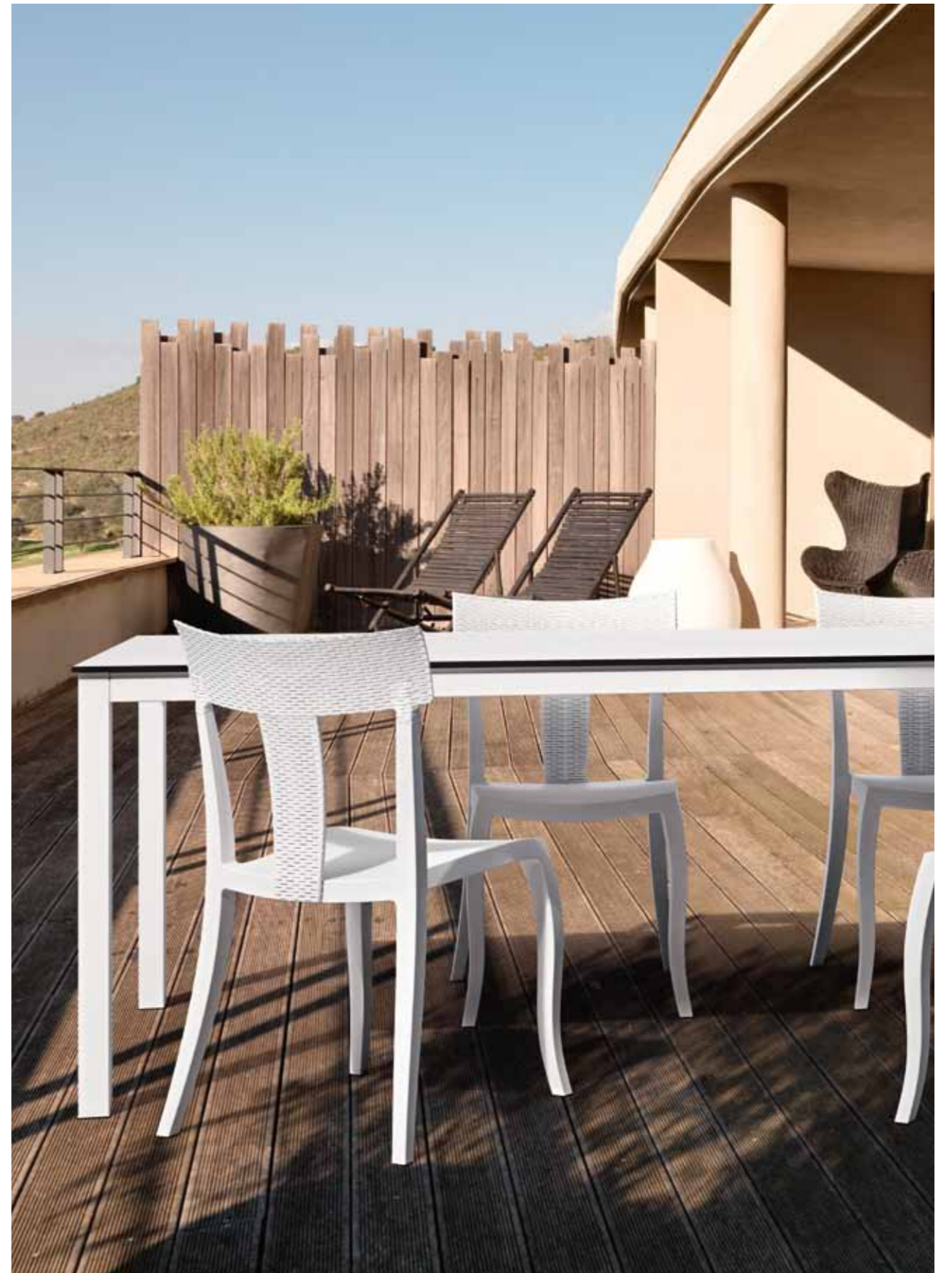

# LUNA COLLECTION

---



Stackable collection comes with two different back designs. Model called Luna Stripe with vertical dynamic lines in glass fiber reinforced polypropylene offers functional and comfortable seating. Fits in any environment.

Model Luna with base in glass fiber reinforced polypropylene and the back in polycarbonate. Combination of two materials and fashionable colors make it a perfect formula which adapts to every functional and aesthetic need. Collection is also available in removable upholstered seat version. Anti UV stabilized. Suitable for indoor and outdoor use.



LUNA



LUNA STRIPE



LUNA STRIPE



46

LUNA | ONIX TABLE

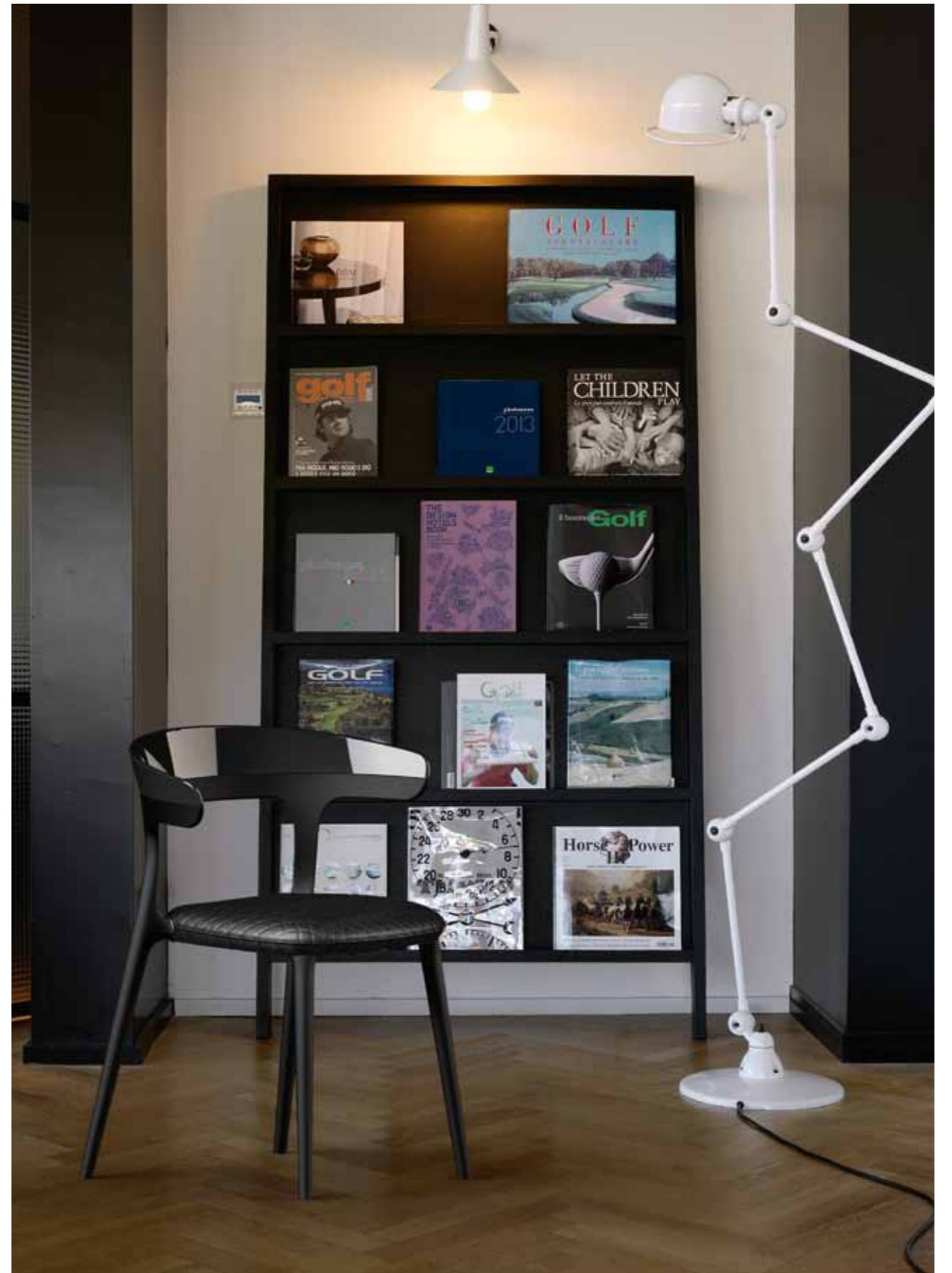

47

LUNA WITH CAP CUSHION





# YUGO COLLECTION

---

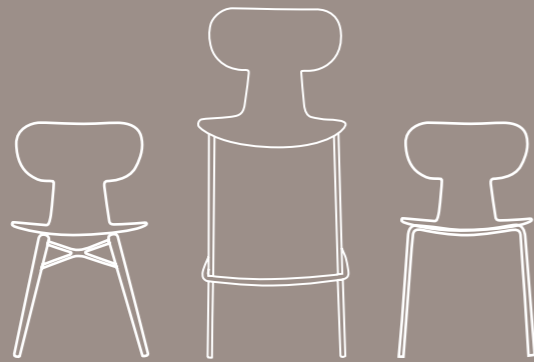

Glassfibre reinforced polypropylene shell combined with various leg options in metal and wood. Yugo chair is sturdy but elastic material to ensure the back is flexible enough for ergonomic use. Adapt naturally to the shape of the human body and the shell allows different and ergonomic sitting positions. Ease of handling and comfort makes the chair usable in many environments, especially very ideal for schools, conference rooms, libraries and all sort of waiting areas, such as those in museums, agencies, offices. Anti UV stabilized. Suitable for outdoors with outdoor resistant leg options. Yugo collection will continue to grow by adding new leg versions. Ideal for contract usages.



YUGO-SWOX



# O'PERA COLLECTION

---

54

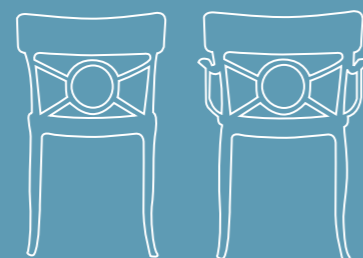

Stackable collection with base in glassfibre reinforced polypropylene and the back in polycarbonate. This traditional collection turns into a contemporary looking collection with combination of the two material and with its fashionable colours make it easily adaptable to every dynamic design environments. Anti UV stabilized. Suitable for indoor and outdoor use. Opera-S and Opera-K also available with rich selection of cushion models. It enriches the collection and gives a distinct character for the interior usages.

55



O'PERA-K







# EGO COLLECTION

---



Stackable collection with base in polypropylene and the back in polycarbonate. Combination of the two material and fashionable colours makes it a perfect formula which adapts to every functional and aesthetic need and fit in any habitat. Anti UV stabilized. Suitable for indoor and outdoor use. Ego Bar models are available in aluminium structure.



EGO-K | EGO-S | EGO ROCK









EGO-ROCK



EGO-ROCK | PUNTO TABLE BASE





EGO ROCK BAR STOOL | EGO ROCK



EGO-K BAR STOOL

# OPAL COLLECTION



## OPAL *PRO*

A new member of Opal range! Natural, warm, contemporary. The organic softness of the glassfibre polypropylene shell in mat colours offers a new way of looking and feeling. It's a pleasant range where you can relax in perfect harmony. Available in all version of the frames from Opal Collection. Offers warm combinations especially in wood frame Opal WOX range. Anti UV stabilized. Designed with public spaces in mind and suitable both for home and contract usages.

## OPAL

Stylish collection exists in two types of expressive transparent and solid colour versions. Shell is made of polycarbonate with steel tube structure named Opal ML, Opal CHIEF with wheels and central base version Opal-M. Anti UV stabilized. Opal armchair is also available in fully upholstered shell version. It enriches the chair and gives a distinct character for the interior usages.

OPAL-WOX range chairs in two attractive wood options is the opposition between the roundy beech wood and square shape iroko wood frame and the shiny, modern seat. Thanks to the transparent or coloured polycarbonate shell, perfect for kitchens, dining rooms and can meet all furnishing needs thanks to the natural beech frame and suiting wide variety of shell colours.

Opal collection is very comfortable. It welcomes the weight of our body and allows us to rest, to work or to sit at a table for a long time. Indeed, it fully fulfils our expectations about sitting. At home, in a café, at the office, we sit everywhere.

With Iroko wood and powder coated steel tube frames suitable for outdoors. Perfect both for home and contract usages.



OPAL-ML





OPAL-ML *PRO*



OPAL WOX WITH BLACK LAQUARED BEECH WOOD LEGS





OPAL WOX WITH IROKO LEGS



OPAL WOX WITH IROKO LEGS | WOX TABLE WITH IROKO LEGS



OPAL WOX WITH BEECH LEGS | OPAL WOX WITH IROKO BEECH LEGS  
OPAL CHIEF | OPAL-M | OPAL-ML **PRO** | OPAL-ML

# X-TREME COLLECTION



## X-TREME *PRO*

A new member of X-Treme range! Natural, warm, contemporary. The organic softness of the glassfibre polypropylene shell in mat colours offers a new way of looking and feeling. It's a pleasant range where you can relax in perfect harmony. Available in all version of the frames from X-Treme Collection. Offers warm combinations especially in wood frame X-Treme WOX range. Anti UV stabilized. Designed with public spaces in mind and suitable both for home and contract usages.

## X-TREME

Collection X-treme has a minimal shape but luxurious appearance, exists in two types of expressive transparent and solid colour versions. Shell is made of polycarbonate with steel tube structure. Anti UV stabilized. X-Treme-S chair is also available in fully upholstered shell version. The range of fabrics brings an even greater level of warmth and comfort to the chairs, to create exclusive combinations.

X-Treme WOX range chairs is entering even to your gardens. It is born with a demand from Garden lovers. It is made of IROKO wood. Natural IROKO wood quadratic shaped gave a new breath to the collection. Iroko can accompany to your lives in outdoors. Available in roundy shape with natural beech wood legs and in many more wood finish colours with lacquered application. X-Treme is a wide collection consist of many variety of bar stools, benches and upholstery options.

X-Treme collection has now become even more comfortable, thanks to the introduction of the soft version which heightens its comfort. The new upholstery applied to the seat surface is covered with many fabric options. This expansion of the X-treme collection further enhances the product, both in terms of aesthetics and comfort, making it even better suitable for domestic and contract usages.



X-TREME S



X-TREME S WOX *PRO* WITH IROKO LEGS  
WOX TABLE WITH IROKO LEGS



X-TREME S WOX WITH BEECH LEGS



X-TREME S | MODUS TABLE BASE



X-TREME BSS | X-TREME BSL



X-TREME B



# FLORA COLLECTION

---

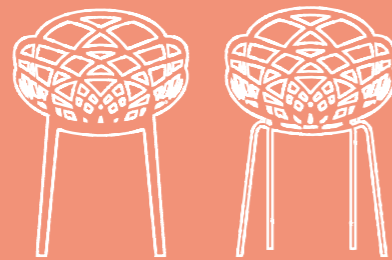

Stackable collection with base in polypropylene or metal and the seat in polycarbonate. Combination of the material and fashionable colours makes the collection a perfect formula which adapts to every functional and aesthetic need and fit any habitat. Anti UV stabilized. Suitable for outdoor and indoor use.







FLORA-PP



FLORA-PP





# GYZA

---

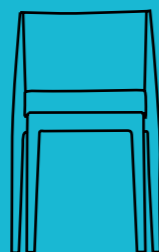

Stackable injected polycarbonate chair in a single piece. Ergonomic shape and attractive colours gives an appealing look. Anti UV stabilized. Suitable for indoor and outdoor use. GYZA chair is available with different cushion options. Appealing fabric and leather covers for the seat enriches the chair and gives an extra comfort.





GYZA



GYZA



GYZA | PUNTO TABLE BASE

# CLASS-X COLLECTION

---

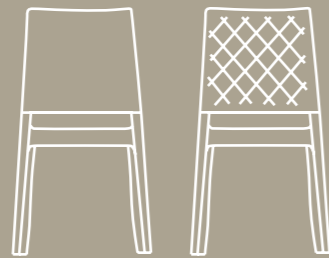

Stackable injected polycarbonate chair in a single piece that is presented in backrest two options with a crystal design or completely clear. The shape of the modern and classic combination makes it inviting and suitable for variety of seating areas. Anti UV stabilized. Suitable for indoor and outdoor use. Class -X chair is available with different cushion options. Appealing fabric and leather covers for the seat enriches the chair and gives an extra comfort.



CLASS-X



110

CLASS-X



111

CLASS-XC Soft | PUNTO TABLE BASE





# EDEN COLLECTION

---

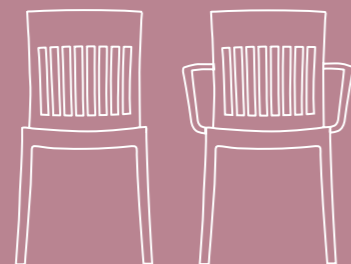

Stackable monobloc collection made of glassfiber reinforced polypropylene. Eden is available with or without armrest with a vertically slatted backrest. Highly comfortable chair thanks to the upholstered seat covered in fabric. The upholstered seat is available in various fabrics and versions. All variations are stackable to allow for large-scale use and storage. Thanks to the protection aparat developed for this chair, made upholstered version stackable without giving any damage to the cushion on stack position. With its simple, clean lines suitable for living/dining areas in both residential and contract places. Anti UV stabilized. Suitable for indoor and outdoor environments.



EDEN-S *Soft*







# MAMBO

---



Stackable monobloc armchair. It is produced with a technology of injection moulding in glassfibre reinforced polypropylene. Ergonomic shape fits in any environment. Thanks to special materials used it is a perfect choice for outdoors. Anti UV stabilized. Mambo is also offers great comfort with its wide variety of colourful fixed and puffy cushion options. Perfectly fits in professional areas.



MAMBO







# COOL

---



Stackable monobloc chair. It is produced with a technology of injection moulding in glassfibre reinforced polypropylene. Ergonomic shape fits in any environment. Thanks to special materials used it is a perfect choice for outdoors. Anti UV stabilized. Cool is also offers great comfort with its wide variety of colourful dressed cushion options. Perfectly suitable for contract usages.

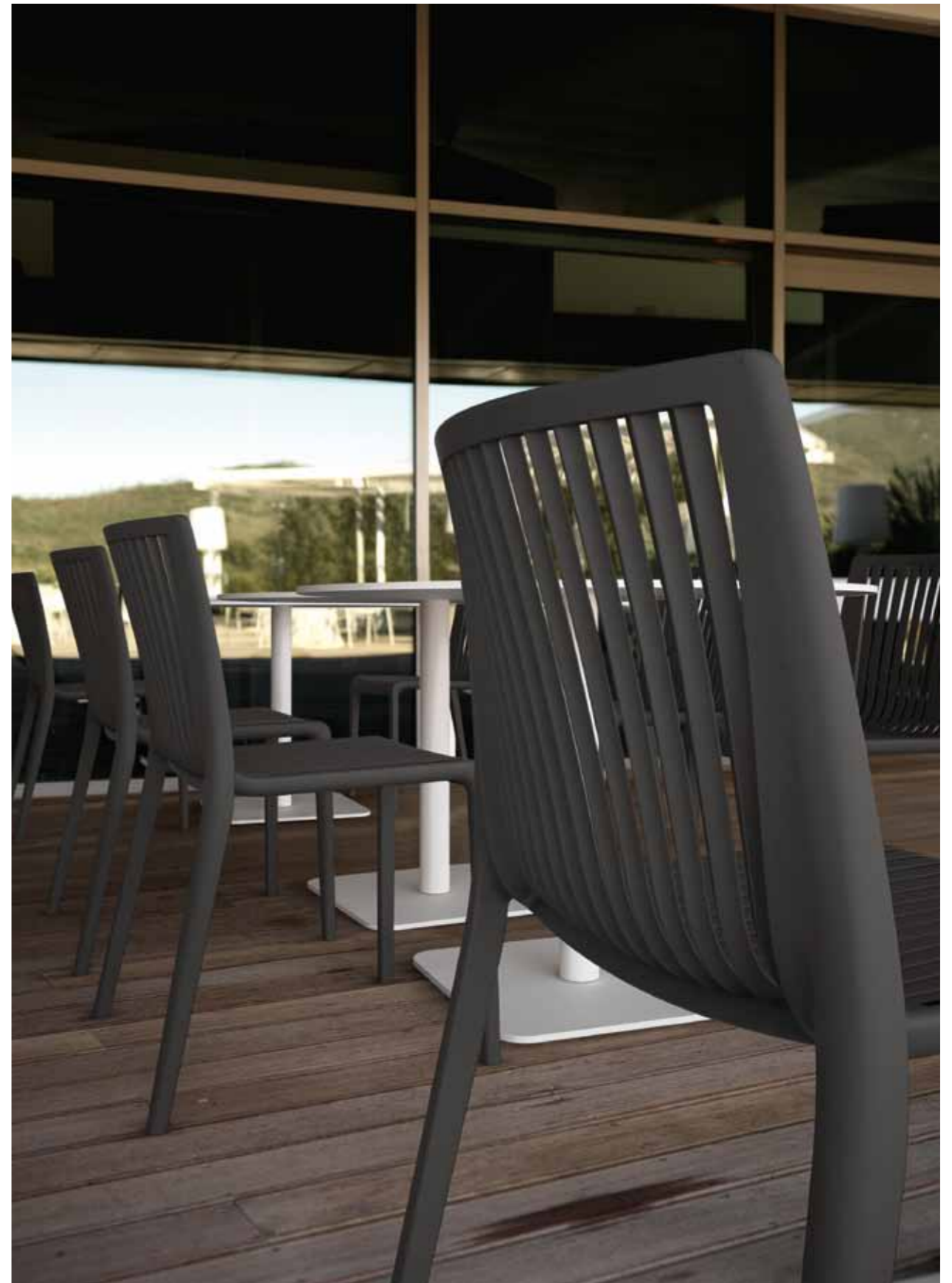

COOL | LOTUS SQUARE TABLE BASE









# NOSTA-S

---

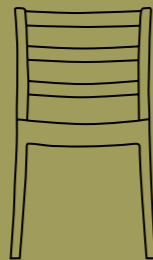

Nosta -S transforms an essential and efficient form to evocative through the texture and warmth of wood. Fibreglass-filled polypropylene injection moulded one-piece chair. Seat can be customized with fixed upholstered cushions. All variations are stackable to allow for large-scale use and storage. Thanks to the protection aparat developed for this chair, made upholstered version stackable without giving any damage to the cushion on stack position. Suitable both for indoor & outdoor environments in residential and contract areas.

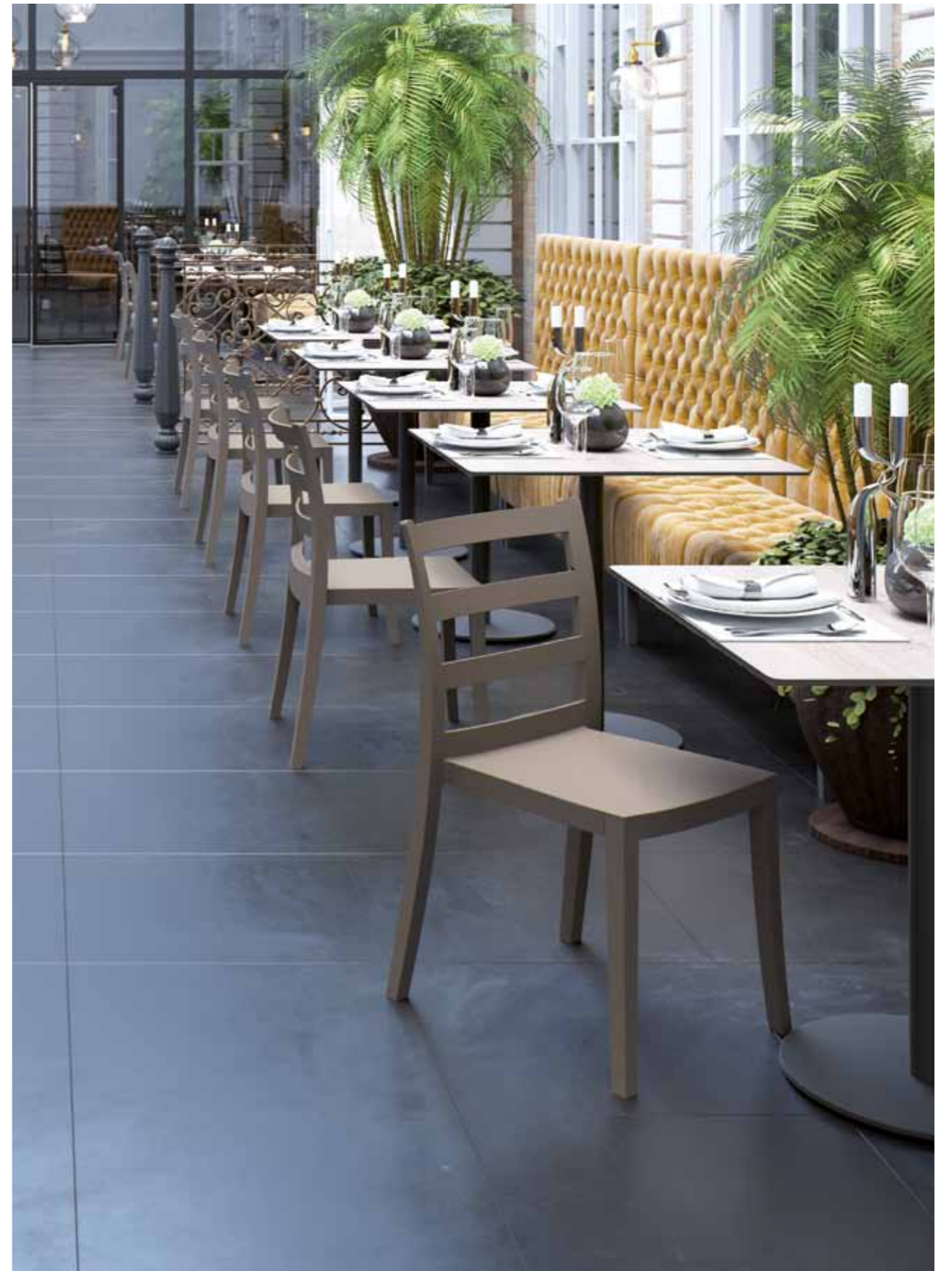

NOSTA - S | LOTUS ROUND TABLE BASE



# VARIA-S

---



Stackable monobloc chair made of glassfiber reinforced polypropylene. Highly comfortable chair thanks to the upholstered seat covered in fabric. The upholstered seat is available in various fabrics and versions. With its simple, clean lines suitable for living/dining areas in both residential and contract places. Anti UV stabilized. Suitable for indoor and outdoor environments.









# YUMMY

---



Stackable monobloc chair. A single piece of polypropylene shaped by injection molding. Natural wood looking texture. Anti UV stabilized. It is a perfect chair for indoor as well as outdoor use.



YUMMY



# TIARA

---



Stackable armchair with stylish design. Impressive solid colours.  
Shell is made of glassfibre reinforced polypropylene and base in steel tube structure. Suitable for indoor and outdoor usage with many frame colour alternatives.  
Anti UV stabilized.

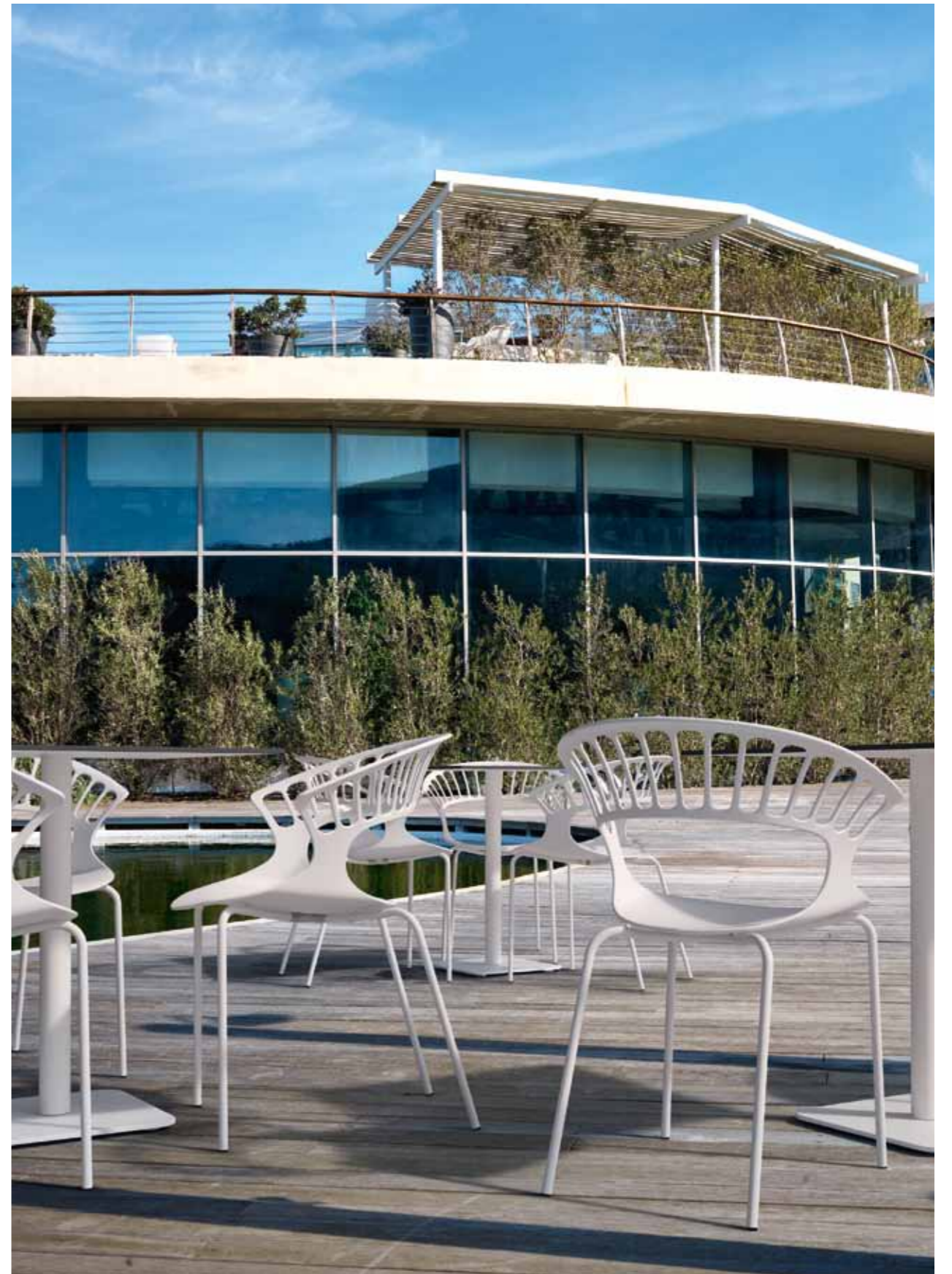

TIARA | LOTUS SQUARE TABLE BASE



# ICON COLLECTION

---

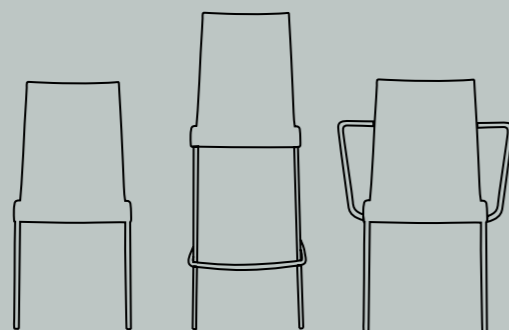

Designed with public spaces in mind, the polypropylene seat is attached to a chromed steel or powder coated steel tube structure. The collection offers a wide range of sitting solutions, with or without armrests, and two different back heights for the stools in pp or in leather upholstery. It can be coupled with other chairs of the same type next to each other in rows by using the plastic connection device for conferences, school and such places. Anti UV stabilized. Suitable for outdoors with outdoor resistant leg options.



ICON-SD





# VITAL COLLECTION

---

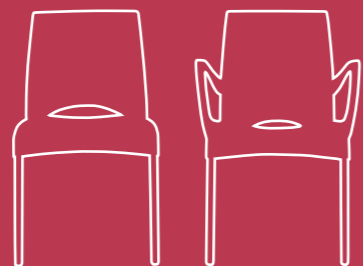

Stackable collection made in polypropylene and anodized satin aluminium. Anti UV stabilized. Also suitable for outdoor use.



VITAL-K | VITAL-S



VITAL-K | PLUS TABLE BASE

# MARVEL-S

---

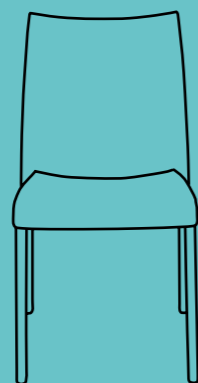

Stackable gas injection chair, made in polypropylene and satin anodized aluminium. It is a sustainable product as the aluminium legs are directly bonded into PP unite and thanks to the hole on the seat rainwater doesn't accumulate on the seat, making drying quicker. Anti UV stabilized. Also suitable for outdoor use.



MARVEL-S



# KAREA

---

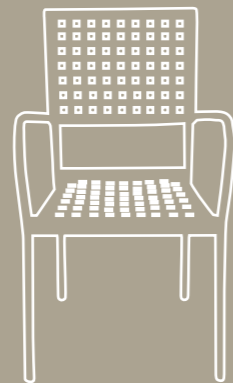

A gas injection armchair, made in polypropylene and satin anodized aluminium. Wood looking texture gives a natural look to the chair. Anti UV stabilized. Suitable for indoor and outdoor use.

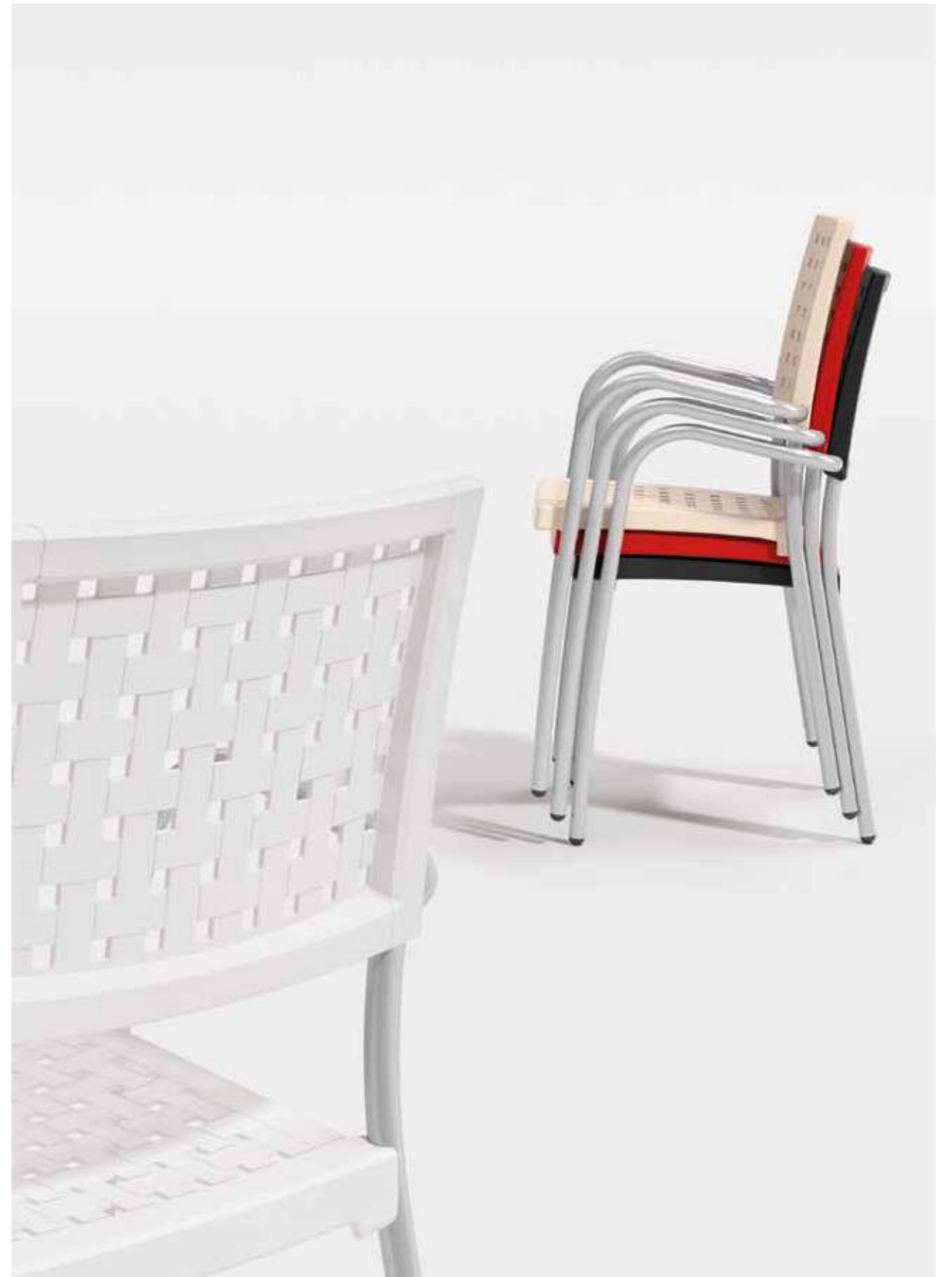

KAREA



KAREA  
OXO TABLE BASE

# WAVE COLLECTION

---

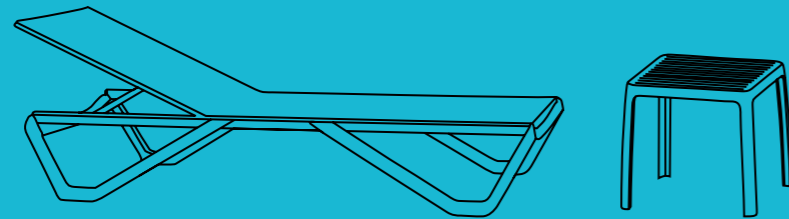

Stackable collection sunlounger with a perfectly matching single piece moulded side table. New generation sunlounger !!! it's the ideal choice for moments of leisure and relaxation. Combining our experience with fresh innovations in injection technology, glassfibre polypropylene and aluminium frame mixation, water-resistant textile material combination takes sunlounger to a whole new level. Open, light shapes and breezy outlines are merged with comfort, the ability to stack, and stability. The wide backrests are ergonomically designed, hugging the body comfortably in a timeless design. Perfectly suitable for both home and contract environments.



WAVE SUNLOUNGER | WAVE SIDE TABLE







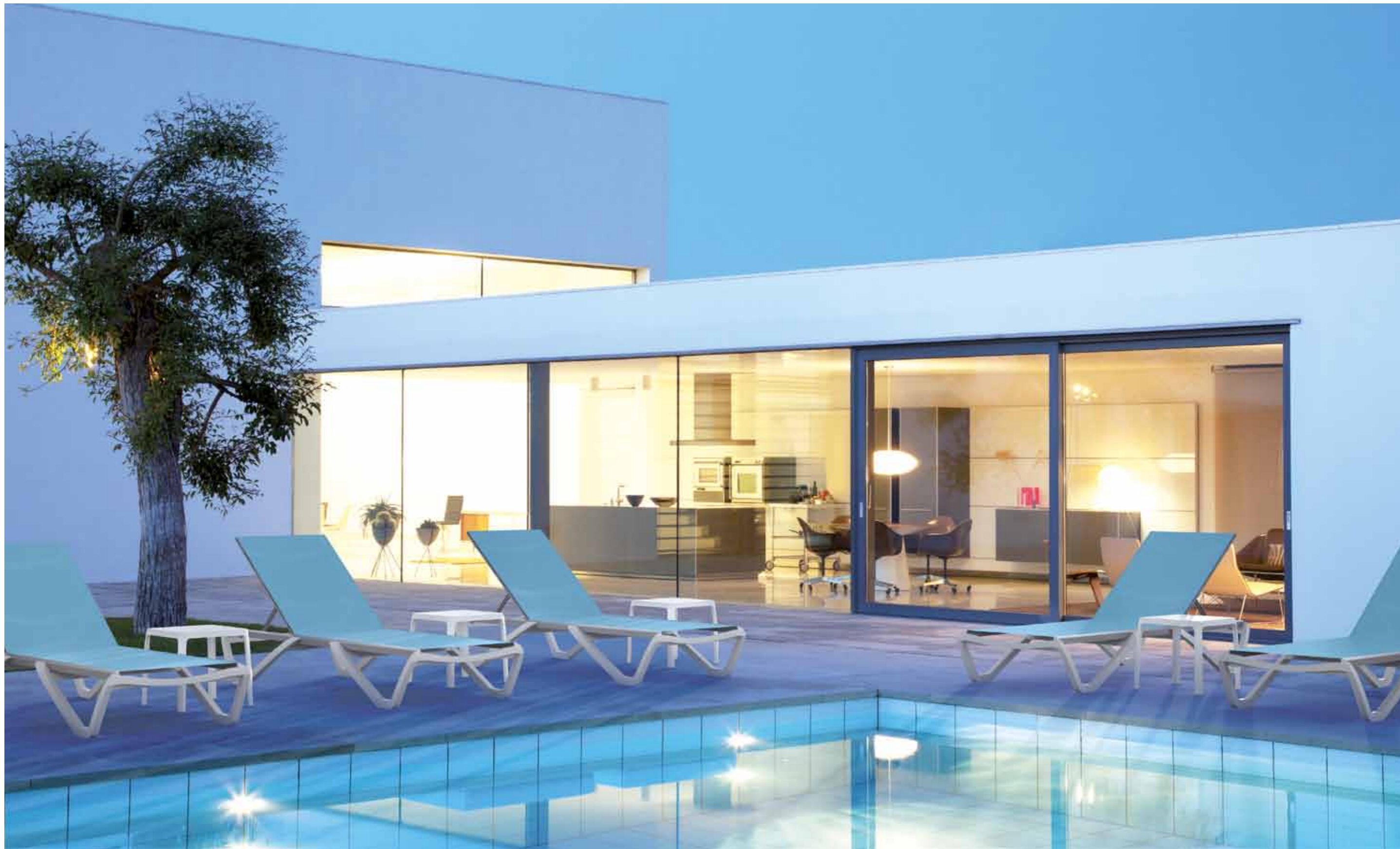

WAVE SUNLOUNGER | WAVE SIDE TABLE



# ZEN COLLECTION

---

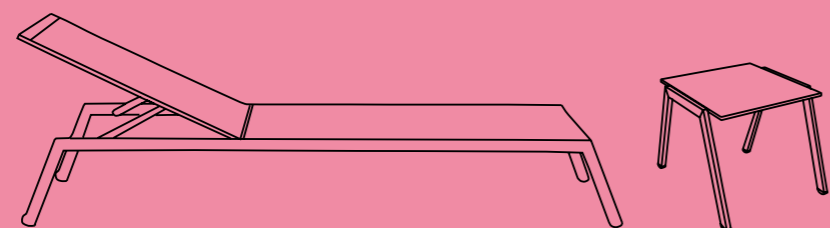

Zen sunlounger made of stainless steel structure with a breathable technical fabric that ensures long-term colour fastness stability. 4 multi-position adjustable backrest and hidden wheels under the back feet for easy moving. Anti UV stabilized. Suitable for indoor and outdoor use.

Zen side table base made of stainless steel and combined with high resistance Solid Compact tops in 625x500 mm . Designed for perfect matching with Zen Sunlonger. Suitable for indoor and outdoor use.

Zen Collection is suitable for both residential and contract places.





# TABLES COLLECTION

---

Tables with modern and clean designs are offering endless possibilities for combining them with other furnitures, and is the ideal solution for diverse ambiances from home to restaurants, where you can share time with others. Together with the top finishes in solid laminate and polymer laminate materials and base varieties from steel to wood proposes rich combination that create elegant designs. The choice of colours offers matching colours with Papatya chairs. Powder coated steel legs are strengthened against rusting and scratches with cathoresis applications. Tables are robust and easy to care for - and therefore perfectly suitable for the contract segment and outdoor usages.

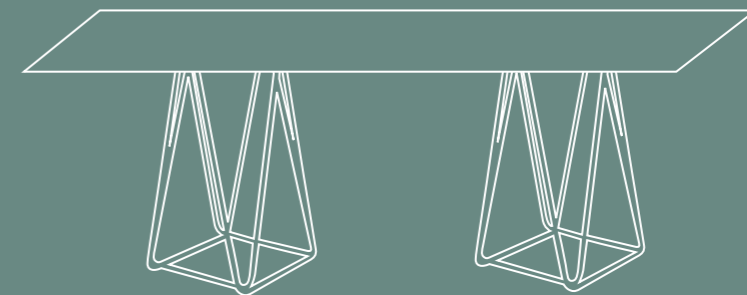
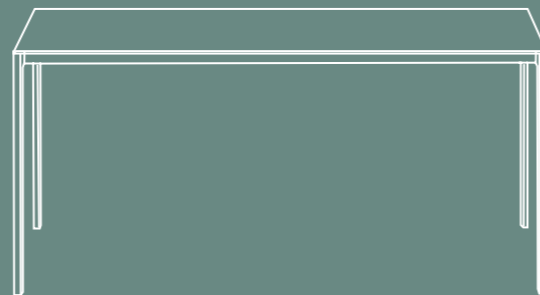
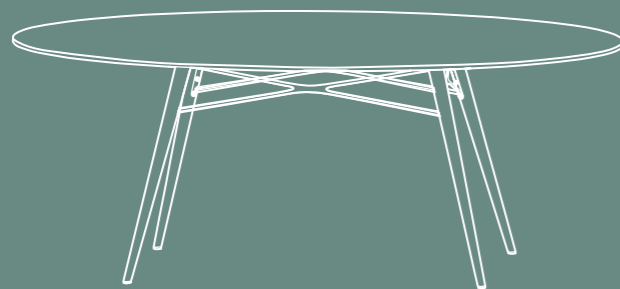

















# TABLE BASES

## COLLECTION

---

Table bases are great pieces of hard wearing furniture, highly versatile and functional with wide ranging applications, different sizes and colours. With such a vast choice of formats and versions, the table bases can be specifically adapted to a given architecture and purpose. Suitable for a wide range of uses, from cafeterias, company restaurants to meeting, beach clubs, terraces. Thanks to extensive variety of shape and sizes in solid laminate and polymer laminate tops enables to create many combinations with all the bases. Powder coated steel legs are strengthened against rusting and scratches with cathodic applications to offer outside usage option. Height adjustable feet property guarantees maximum stability and ideal for uneven surfaces where leveling is required.

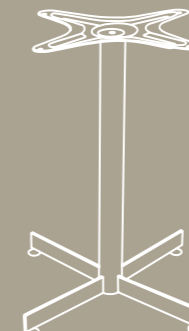
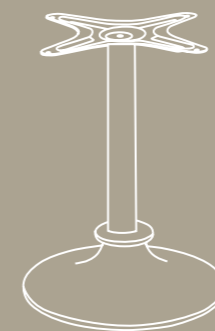
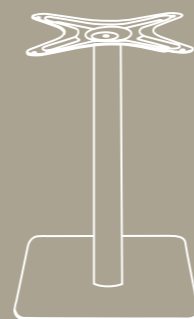
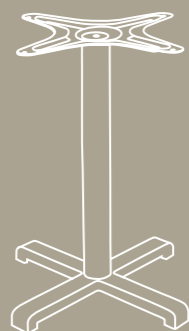













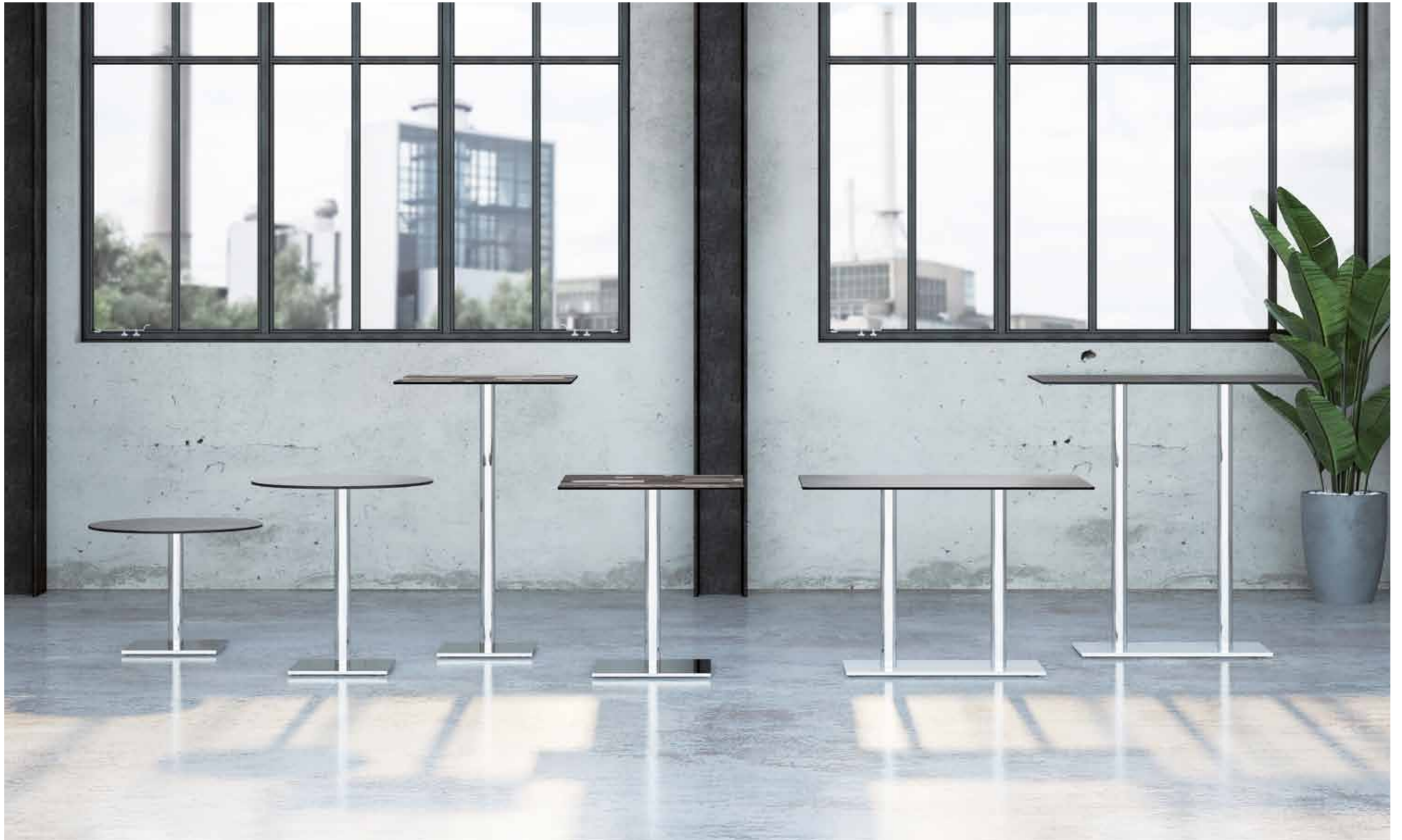





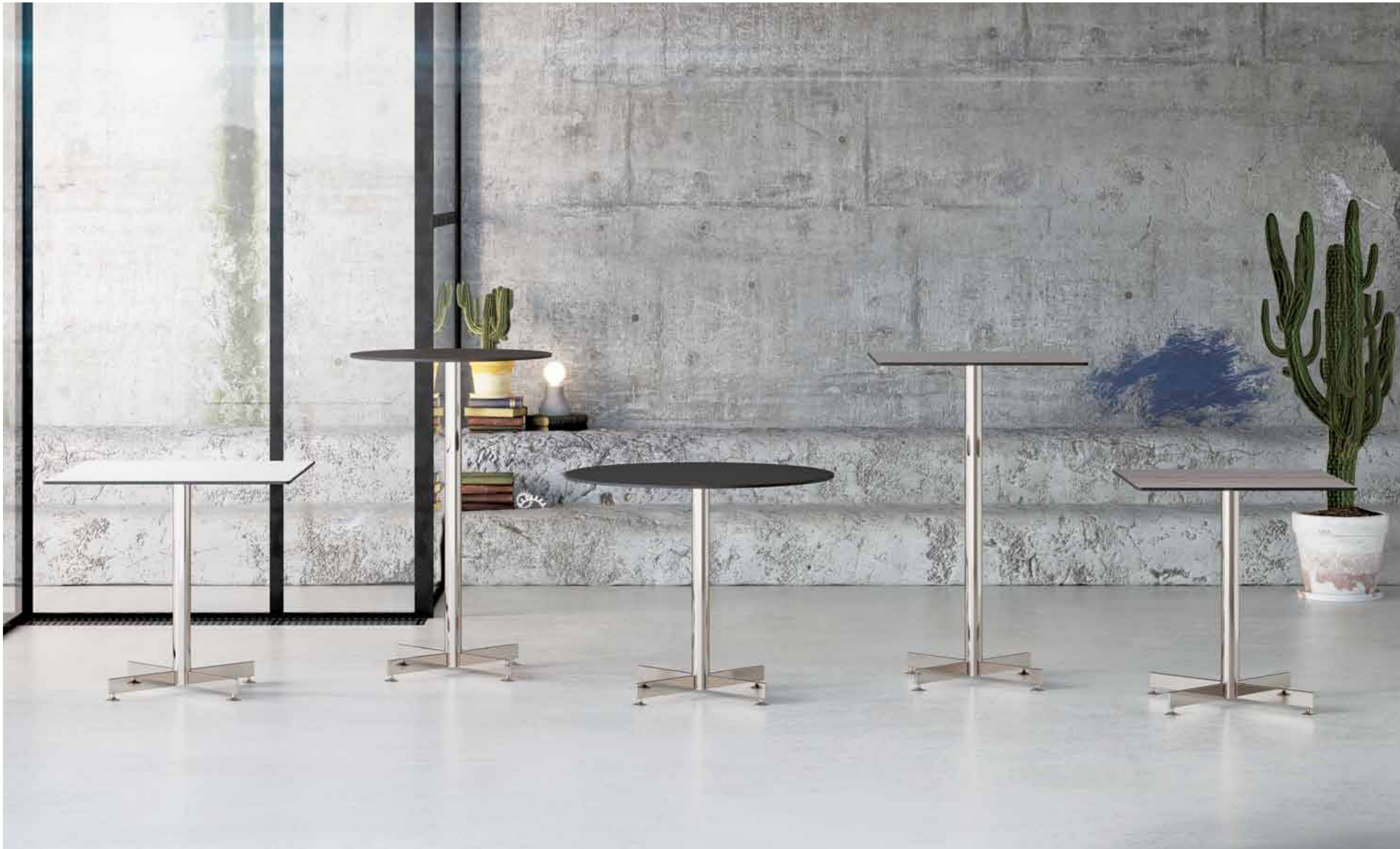

CUSHIONS &  
UPHOLSTERED  
CHAIRS AND STOOLS



# REMOVABLE CUSHIONS

<p><b>X'SERA-S</b> with dressed cushion</p> <p>COVER TYPES: Antelop / Pandora / Genetic Capitone / Stamskin</p> 	<p><b>TRIO-S</b> with dressed cushion</p> <p>COVER TYPES: Antelop / Pandora / Genetic Capitone / Stamskin</p> 	<p><b>HERA-S</b> with dressed cushion</p> <p>COVER TYPES: Antelop / Pandora / Genetic Capitone / Stamskin</p> 	<p><b>HERA-K</b> with dressed cushion</p> <p>COVER TYPES: Antelop / Pandora / Genetic Capitone / Stamskin</p> 	<p><b>HERA-SP</b> with dressed cushion</p> <p>COVER TYPES: Antelop / Pandora / Genetic Capitone / Stamskin</p> 	<p><b>HERA-SP Rattan</b> with dressed cushion</p> <p>COVER TYPES: Antelop / Pandora / Genetic Capitone / Stamskin</p> 
--	---	---	---	---	---

<p><b>TORO-S</b> with dressed cushion</p> <p>COVER TYPES: Antelop / Pandora / Genetic Capitone / Stamskin</p> 	<p><b>TORO-S Rattan</b> with dressed cushion</p> <p>COVER TYPES: Antelop / Pandora / Genetic Capitone / Stamskin</p> 	<p><b>OPERA-S</b> with dressed cushion</p> <p>COVER TYPES: Antelop / Pandora / Genetic Capitone / Stamskin</p> 	<p><b>OPERA-K</b> with dressed cushion</p> <p>COVER TYPES: Antelop / Pandora / Genetic Capitone / Stamskin</p> 	<p><b>LUNA</b> with cap cushion</p> <p>COVER TYPES: Antelop / Pandora / Genetic Capitone / Stamskin</p> 	<p><b>LUNA STRIPE</b> with cap cushion</p> <p>COVER TYPES: Antelop / Pandora / Genetic Capitone / Stamskin</p> 
--	--	--	--	--	--

<p><b>EGO-S</b> with dressed cushion</p> <p>COVER TYPES: Antelop / Pandora / Genetic Stamskin</p> 	<p><b>EGO-K</b> with dressed cushion</p> <p>COVER TYPES: Antelop / Pandora / Genetic Stamskin</p> 	<p><b>EGO-ROCK</b> with dressed cushion</p> <p>COVER TYPES: Antelop / Pandora / Genetic Stamskin</p> 	<p><b>OPAL</b> with puffy cushion (LONG)</p> <p>COVER TYPES: Linen</p> 	<p><b>OPAL</b> with puffy cushion (SHORT)</p> <p>COVER TYPES: Linen</p> 	<p><b>OPAL</b> with sticked cushion</p> <p>COVER TYPES: Antelop / Pandora / Genetic Capitone</p> 
---	--	---	---	---	---

<p><b>OPAL</b> with evo cushion</p> <p>COVER TYPES: Pandora</p> 	<p><b>GYZA</b> with dressed cushion</p> <p>COVER TYPES: Antelop / Pandora / Genetic Capitone / Stamskin</p> 	<p><b>GYZA</b> with sticked cushion</p> <p>COVER TYPES: Antelop / Pandora / Genetic Capitone / Stamskin</p> 	<p><b>CLASS-X / CLASS-XC</b> with dressed cushion</p> <p>COVER TYPES: Antelop / Pandora / Genetic Capitone / Stamskin</p> 	<p><b>CLASS-X / CLASS-XC</b> with sticked cushion</p> <p>COVER TYPES: Antelop / Pandora / Genetic Capitone / Stamskin</p> 
--	---	---	---	---

<p><b>EDEN-S</b> with foam cushion</p> <p>COVER TYPES: Linen</p> 	<p><b>EDEN-K</b> with foam cushion</p> <p>COVER TYPES: Linen</p> 	<p><b>MAMBO</b> with puffy cushion (LONG)</p> <p>COVER TYPES: Linen</p> 	<p><b>MAMBO</b> with puffy cushion (SHORT)</p> <p>COVER TYPES: Linen</p> 	<p><b>COOL</b> with dressed cushion</p> <p>COVER TYPES: Antelop / Pandora / Genetic Stamskin</p> 	<p><b>VARIA-S</b> with foam cushion</p> <p>COVER TYPES: Linen</p> 
---	--	---	--	---	---

# FIXED CUSHIONS

<p><b>JOY-S</b> Soft</p> <p>COVER TYPES: Genetic / Linen/ Stamskin Eden</p> 	<p><b>JOY-S</b> Soft</p> <p>COVER TYPES: Genetic / Linen/ Stamskin Eden</p> 	<p><b>JOY-K</b> Soft</p> <p>COVER TYPES: Genetic / Linen/ Stamskin Eden</p> 	<p><b>JOY-K</b> Soft</p> <p>COVER TYPES: Genetic / Linen/ Stamskin Eden</p> 	<p><b>X'SERA-S</b> Soft</p> <p>COVER TYPES: Antelop / Pandora / Genetic Capitone / Stamskin / Eden</p> 	<p><b>TRIO-S</b> Soft</p> <p>COVER TYPES: Antelop / Pandora / Genetic Capitone / Stamskin / Eden</p> 
---	---	---	---	--	--

<p><b>HERA-S</b> Soft</p> <p>COVER TYPES: Antelop / Pandora / Genetic Capitone / Stamskin / Eden</p> 	<p><b>HERA-K</b> Soft</p> <p>COVER TYPES: Antelop / Pandora / Genetic Capitone / Stamskin / Eden</p> 	<p><b>HERA-SP</b> Soft</p> <p>COVER TYPES: Antelop / Pandora / Genetic Capitone / Stamskin / Eden</p> 	<p><b>HERA-SP Rattan</b> Soft</p> <p>COVER TYPES: Antelop / Pandora / Genetic Capitone / Stamskin / Eden</p> 	<p><b>MAMBO</b> Soft</p> <p>COVER TYPES: Antelop / Pandora / Genetic Capitone / Stamskin / Eden</p> 
--	--	---	--	---

<p><b>TORO-S</b> Soft</p> <p>COVER TYPES: Antelop / Pandora / Genetic Capitone / Stamskin / Eden</p> 	<p><b>TORO-S Rattan</b> Soft</p> <p>COVER TYPES: Antelop / Pandora / Genetic Capitone / Stamskin / Eden</p> 	<p><b>OPERA-S</b> Soft</p> <p>COVER TYPES: Antelop / Pandora / Genetic Capitone / Stamskin / Eden</p> 	<p><b>OPERA-K</b> Soft</p> <p>COVER TYPES: Antelop / Pandora / Genetic Capitone / Stamskin / Eden</p> 	<p><b>EDEN-S</b> Soft</p> <p>COVER TYPES: Antelop / Pandora / Genetic Capitone / Stamskin / Eden</p> 	<p><b>EDEN-K</b> Soft</p> <p>COVER TYPES: Antelop / Pandora / Genetic Capitone / Stamskin / Eden</p> 
---	--	--	--	---	---

<p><b>X-TREME S</b> Soft</p> <p>COVER TYPES: Genetic / Linen</p> 	<p><b>X-TREME S WOX</b> Soft</p> <p>COVER TYPES: Genetic / Linen</p> 
--	--

UPHOLSTERED

OPAL-KD



OPAL-KD WOX



OPAL-MD



COVER TYPE:  
Genetic

X-TREME-SD



X-TREME-BSLD



X-TREME-BSSD



COVER TYPE:  
Genetic

X-TREME-SLED D



X-TREME-BD



COVER TYPE:  
Genetic

X-TREME-SD WOX with beech wood legs



COVER TYPE:  
Genetic

ICON-SD



ICON-BD



ICON-BDK



COVER TYPE:  
Artificial leather

PAPATYA®

CHAIRS AND STOOLS

JOY COLLECTION

JOY-S

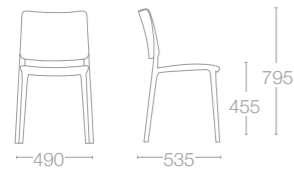

PP FINISH COLOURS

- 01 White
- 04 Red
- 09 Black
- 17 Warm Grey
- 22 Anthracite
- 61 Taupe
- 65 Sandy Beige
- 70 Aqua Blue
- 72 Orange

JOY-S Bar stool / 75 CM

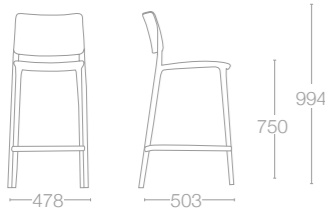

PP FINISH COLOURS

- 01 White
- 04 Red
- 17 Warm Grey
- 22 Anthracite
- 61 Taupe
- 70 Aqua Blue

JOY-S Bar stool / 65 CM

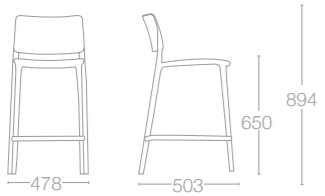

PP FINISH COLOURS

- 01 White
- 04 Red
- 17 Warm Grey
- 22 Anthracite
- 61 Taupe
- 70 Aqua Blue

JOY-K

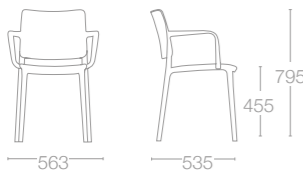

PP FINISH COLOURS

- 01 White
- 04 Red
- 09 Black
- 17 Warm Grey
- 22 Anthracite
- 61 Taupe
- 65 Sandy Beige
- 70 Aqua Blue
- 72 Orange

FAME COLLECTION

FAME-S

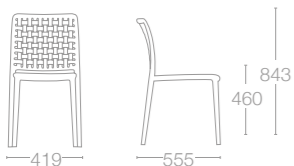

PP FINISH COLOURS

- 01 White
- 04 Red
- 22 Anthracite
- 61 Taupe
- 65 Sandy Beige

FAME-S Bar stool / 75 CM

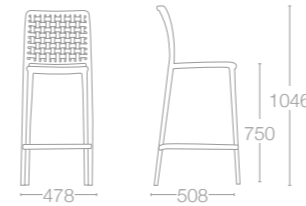

PP FINISH COLOURS

- 01 White
- 04 Red
- 22 Anthracite
- 61 Taupe

FAME-S Bar stool / 65 CM

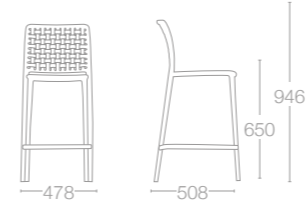

PP FINISH COLOURS

- 01 White
- 04 Red
- 22 Anthracite
- 61 Taupe

FAME-K

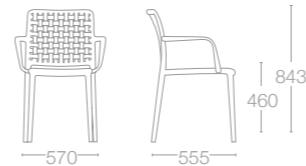

PP FINISH COLOURS

- 01 White
- 04 Red
- 22 Anthracite
- 61 Taupe
- 65 Sandy Beige

X'SERA

X'SERA-S

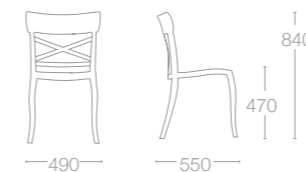

PP FINISH COLOURS

- 01 White
- 04 Red
- 65 Sandy Beige
- 67 Navy Blue
- 68 Canary Yellow
- 69 Reseda Green
- 70 Aqua Blue
- 71 Urban Bronze
- 72 Orange

TRIO

TRIO-S



PP FINISH COLOURS

- 01 White
- 09 Black
- 22 Anthracite
- 61 Taupe
- 65 Sandy Beige

HERA COLLECTION

HERA-S

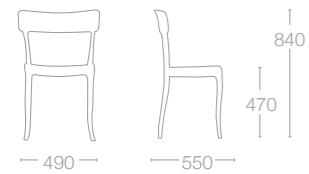

- SEAT: PP FINISH COLOURS
- 01 White
  - 09 Black
  - 22 Anthracite
  - 65 Sandy Beige

- BACK: PC GLOSSY FINISH (TRANSPARENT) COLOURS
- 28 Purple
  - 29 Red
  - 33 Orange
  - 35 Green
  - 37 Clear
  - 38 Smoke
  - 40 Blue

- BACK: PC GLOSSY FINISH (SOLID) COLOURS
- 42 Black
  - 43 White

HERA-K

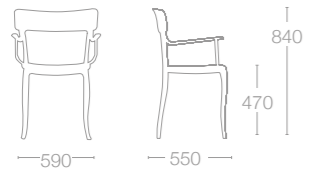

- SEAT: PP FINISH COLOURS
- 01 White
  - 09 Black
  - 22 Anthracite
  - 65 Sandy Beige

- BACK: PC GLOSSY FINISH (TRANSPARENT) COLOURS
- 28 Purple
  - 29 Red
  - 33 Orange
  - 35 Green
  - 37 Clear
  - 38 Smoke
  - 40 Blue

- BACK: PC GLOSSY FINISH (SOLID) COLOURS
- 42 Black
  - 43 White

HERA-SP

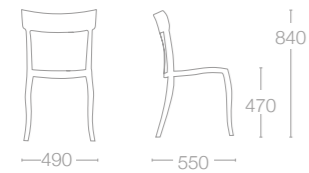

- PP FINISH COLOURS
- 01 White
  - 09 Black
  - 22 Anthracite
  - 61 Taupe
  - 65 Sandy Beige

HERA-SP Rattan

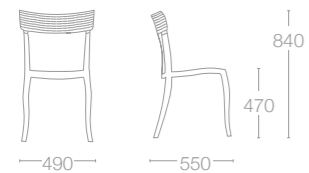

- PP FINISH COLOURS
- 01 White
  - 22 Anthracite
  - 53 Dark Brown
  - 65 Sandy Beige
  - 66 Storm Grey

TORO COLLECTION

TORO-S

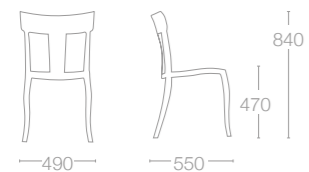

- PP FINISH COLOURS
- 01 White
  - 09 Black
  - 22 Anthracite
  - 61 Taupe
  - 65 Sandy Beige

TORO-S Rattan

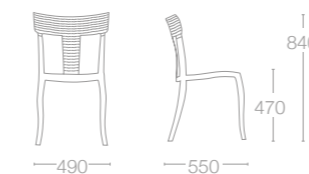

- PP FINISH COLOURS
- 01 White
  - 22 Anthracite
  - 53 Dark Brown
  - 65 Sandy Beige
  - 66 Storm Grey

LUNA COLLECTION

LUNA

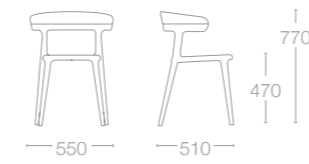

- SEAT: PP FINISH COLOURS
- 01 White
  - 09 Black
  - 22 Anthracite
  - 61 Taupe

- BACK: PC GLOSSY FINISH (TRANSPARENT) COLOURS
- 28 Purple
  - 29 Red
  - 33 Orange
  - 35 Green
  - 37 Clear
  - 38 Smoke
  - 40 Blue

- BACK: PC GLOSSY FINISH (SOLID) COLOURS
- 42 Black
  - 43 White

LUNA STRIPE

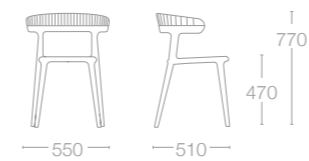

- PP FINISH COLOURS
- 01 White
  - 09 Black
  - 22 Anthracite
  - 61 Taupe

YUGO COLLECTION

YUGO-S

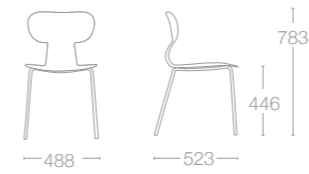

- SEAT: PP FINISH COLOURS
- 01 White
  - 04 Red
  - 09 Black
  - 22 Anthracite
  - 64 Reflex Blue
  - 68 Canary Yellow
  - 69 Reseda Green

FRAME COLOURS

- Chrome plated
- Anthracite powder coated
- Black powder coated
- White powder coated

Powder coated (mat): Streghtned against rusting and scratches with cataphorensis application.

On request the base could be produced special paint applications; silver metallic

YUGO-S Bar stool

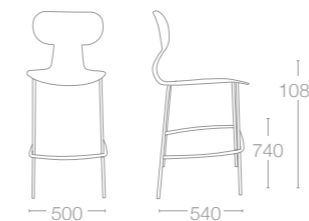

- SEAT: PP FINISH COLOURS
- 01 White
  - 04 Red
  - 09 Black
  - 22 Anthracite
  - 64 Reflex Blue
  - 68 Canary Yellow
  - 69 Reseda Green

FRAME COLOURS

- Chrome plated

YUGO COLLECTION

YUGO-S WOX



SEAT: PP FINISH COLOURS

- 01 White
- 04 Red
- 09 Black
- 22 Anthracite
- 64 Reflex Blue
- 68 Canary Yellow
- 69 Reseda Green

WOODEN LEG FINISHES

- Natural beech wood
- Wenge lacquered beech wood
- Black lacquered beech wood
- White lacquered beech wood

METAL STRAPS FINISHES

- Anthracite

On request the strap could be produced in with white (mat) finish. For not standards colours please check the price and delivery time.

O'PERA COLLECTION

O'PERA-S

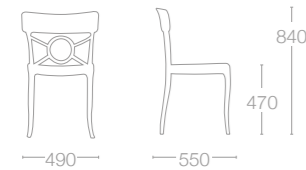

SEAT: PP FINISH COLOURS

- 01 White
- 09 Black
- 22 Anthracite

BACK: PC GLOSSY FINISH (TRANSPARENT) COLOURS

- 29 Red
- 37 Clear
- 38 Smoke

BACK: PC GLOSSY FINISH (SOLID) COLOURS

- 42 Black
- 43 White

O'PERA-K

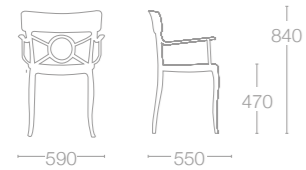

SEAT: PP FINISH COLOURS

- 01 White
- 09 Black
- 22 Anthracite

BACK: PC GLOSSY FINISH (TRANSPARENT) COLOURS

- 29 Red
- 37 Clear
- 38 Smoke

BACK: PC GLOSSY FINISH (SOLID) COLOURS

- 42 Black
- 43 White

EGO COLLECTION

EGO-S

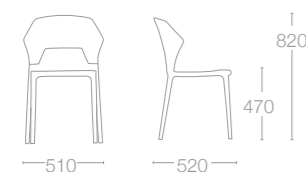

SEAT: PP FINISH COLOURS

- 01 White
- 09 Black
- 22 Anthracite

BACK: PC GLOSSY FINISH (TRANSPARENT) COLOURS

- 28 Purple
- 29 Red
- 33 Orange
- 35 Green
- 37 Clear
- 38 Smoke
- 40 Blue

BACK: PC GLOSSY FINISH (SOLID) COLOURS

- 42 Black

EGO-S Bar stool

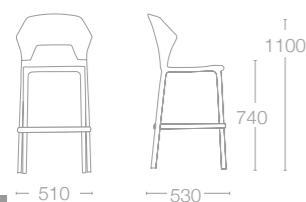

SEAT: PP FINISH COLOURS

- 01 White
- 09C Black
- 22C Anthracite

BACK: PC GLOSSY FINISH (TRANSPARENT) COLOURS

- 28 Purple
- 29 Red
- 33 Orange
- 35 Green
- 37 Clear
- 38 Smoke
- 40 Blue

BACK: PC GLOSSY FINISH (SOLID) COLOURS

- 42 Black

FRAME COLOURS

- Satin anodized aluminium
- White painted aluminium (mat)
- Black painted aluminium (mat)
- Anthracite painted aluminium (mat)

EGO-K

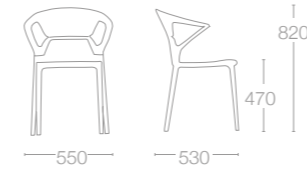

SEAT: PP FINISH COLOURS

- 01 White
- 09 Black
- 22 Anthracite

BACK: PC GLOSSY FINISH (TRANSPARENT) COLOURS

- 28 Purple
- 29 Red
- 33 Orange
- 35 Green
- 37 Clear
- 38 Smoke
- 40 Blue

BACK: PC GLOSSY FINISH (SOLID) COLOURS

- 42 Black

EGO-K Bar stool

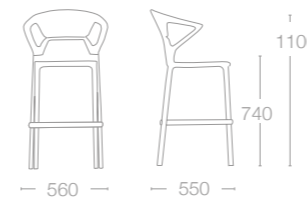

SEAT: PP FINISH COLOURS

- 01 White
- 09C Black
- 22C Anthracite

BACK: PC GLOSSY FINISH (TRANSPARENT) COLOURS

- 28 Purple
- 29 Red
- 33 Orange
- 35 Green
- 37 Clear
- 38 Smoke
- 40 Blue

BACK: PC GLOSSY FINISH (SOLID) COLOURS

- 42 Black

FRAME COLOURS

- Satin anodized aluminium
- White painted aluminium (mat)
- Black painted aluminium (mat)
- Anthracite painted aluminium (mat)

EGO ROCK

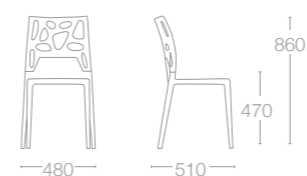

SEAT: PP FINISH COLOURS

- 01 White
- 09 Black
- 22 Anthracite

BACK: PC GLOSSY FINISH (TRANSPARENT) COLOURS

- 28 Purple
- 29 Red
- 33 Orange
- 35 Green
- 37 Clear
- 38 Smoke
- 40 Blue

BACK: PC GLOSSY FINISH (SOLID) COLOURS

- 42 Black
- 43 White
- 44 Red

EGO ROCK Bar stool

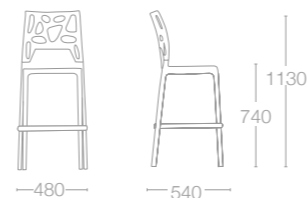

SEAT: PP FINISH COLOURS

- 01 White
- 09C Black
- 22C Anthracite

BACK: PC GLOSSY FINISH (TRANSPARENT) COLOURS

- 28 Purple
- 29 Red
- 33 Orange
- 35 Green
- 37 Clear
- 38 Smoke
- 40 Blue

BACK: PC GLOSSY FINISH (SOLID) COLOURS

- 42 Black
- 43 White
- 44 Red

FRAME COLOURS

- Satin anodized aluminium
- White painted aluminium (mat)
- Black painted aluminium (mat)
- Anthracite painted aluminium (mat)

OPAL COLLECTION

OPAL-ML

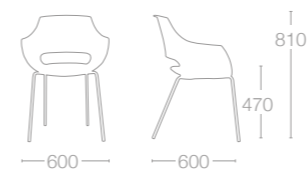

SEAT: PC GLOSSY FINISH (TRANSPARENT) COLOURS

- 29 Red
- 33 Orange
- 35 Green
- 37 Clear
- 38 Smoke
- 40 Blue

SEAT: PC GLOSSY FINISH (SOLID) COLOURS

- 42 Black
- 43 White
- 44 Red

FRAME COLOURS

- Chrome plated
- on request: the base could be produced with outdoor resistant special paint applications. Powder coated (mat): White, Anthracite, Black

OPAL WOX With beech wood leg

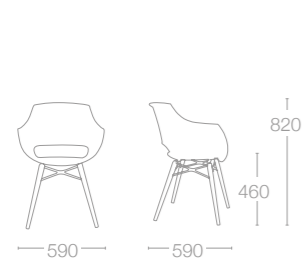

- SEAT: PC GLOSSY FINISH (TRANSPARENT) COLOURS
- 29 Red
  - 33 Orange
  - 35 Green
  - 37 Clear
  - 38 Smoke
  - 40 Blue

- SEAT: PC GLOSSY FINISH (SOLID) COLOURS
- 42 Black
  - 43 White
  - 44 Red

- WOODEN LEG FINISHES
- Natural beech wood
  - Wenge lacquered beech wood
  - Black lacquered beech wood
  - White lacquered beech wood

METAL STRAPS FINISHES

- Anthracite

On request the strap could be produced in with white (mat) finish. For not standards colours please check the price and delivery time.

OPAL WOX With iroko wood leg

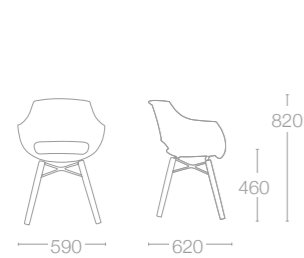

- SEAT: PC GLOSSY FINISH (TRANSPARENT) COLOURS
- 29 Red
  - 33 Orange
  - 35 Green
  - 37 Clear
  - 38 Smoke
  - 40 Blue

- SEAT: PC GLOSSY FINISH (SOLID) COLOURS
- 42 Black
  - 43 White
  - 44 Red

- WOODEN LEG FINISHES
- Natural iroko wood (with colour stabilized oil treatment) Due to the nature of the iroko wood colour tone may differ in each purchase.

METAL STRAPS FINISHES

- Anthracite

On request the strap could be produced in with white (mat) finish. For not standards colours please check the price and delivery time.

OPAL-M

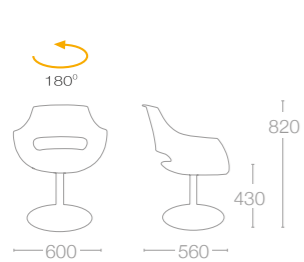

- SEAT: PC GLOSSY FINISH (SOLID) COLOURS
- 42 Black
  - 43 White
  - 44 Red

- FRAME COLOURS
- Chrome plated

OPAL CHIEF

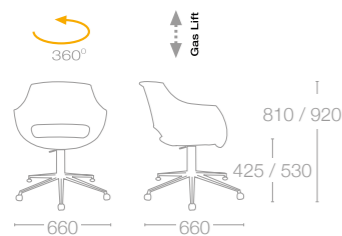

- SEAT: PC GLOSSY FINISH (SOLID) COLOURS
- 42 Black
  - 43 White
  - 44 Red

- FRAME COLOURS
- Chrome plated

OPAL-ML PRO

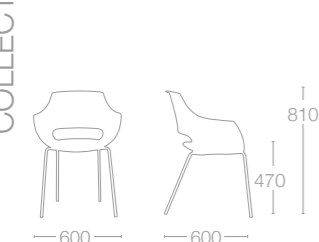

- SEAT: PP FINISH COLOURS
- 01 White
  - 09 Black
  - 22 Anthracite
  - 51 Brick Red
  - 52 Dark Yellow
  - 61 Taupe
  - 69 Reseda Green

- FRAME COLOURS
- Chrome plated
- on request: the base could be produced with outdoor resistant special paint applications. Powder coated (mat): **White, Anthracite, Black**

OPAL WOX PRO With beech wood leg

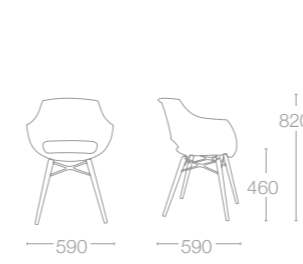

- SEAT: PP FINISH COLOURS
- 01 White
  - 09 Black
  - 22 Anthracite
  - 51 Brick Red
  - 52 Dark Yellow
  - 61 Taupe
  - 69 Reseda Green

- WOODEN LEG FINISHES
- Natural beech wood
  - Wenge lacquered beech wood
  - Black lacquered beech wood
  - White lacquered beech wood

METAL STRAPS FINISHES

- Anthracite

On request the strap could be produced in with white (mat) finish. For not standards colours please check the price and delivery time.

OPAL WOX PRO With iroko wood leg

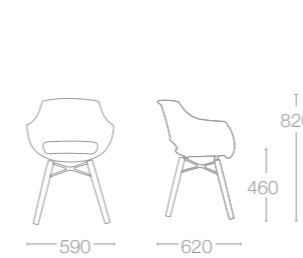

- SEAT: PP FINISH COLOURS
- 01 White
  - 09 Black
  - 22 Anthracite
  - 51 Brick Red
  - 52 Dark Yellow
  - 61 Taupe
  - 69 Reseda Green

- WOODEN LEG FINISHES
- Natural iroko wood (with colour stabilized oil treatment) Due to the nature of the iroko wood colour tone may differ in each purchase.

METAL STRAPS FINISHES

- Anthracite

On request the strap could be produced in with white (mat) finish. For not standards colours please check the price and delivery time.

OPAL-M PRO

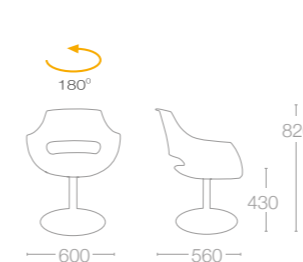

- SEAT: PP FINISH COLOURS
- 01 White
  - 09 Black
  - 22 Anthracite
  - 51 Brick Red
  - 52 Dark Yellow
  - 61 Taupe
  - 69 Reseda Green

- FRAME COLOURS
- Chrome plated

OPAL CHIEF PRO

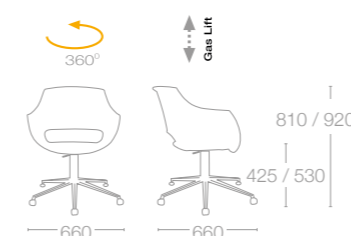

- SEAT: PP FINISH COLOURS
- 01 White
  - 09 Black
  - 22 Anthracite
  - 51 Brick Red
  - 52 Dark Yellow
  - 61 Taupe
  - 69 Reseda Green

- FRAME COLOURS
- Chrome plated

X-TREME-S

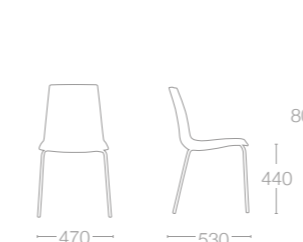

- SEAT: PC GLOSSY FINISH (TRANSPARENT) COLOURS
- 29 Red
  - 33 Orange
  - 35 Green
  - 37 Clear
  - 38 Smoke
  - 40 Blue

- SEAT: PC GLOSSY FINISH (SOLID) COLOURS
- 42 Black
  - 43 White
  - 44 Red

- FRAME COLOURS
- Chrome plated

on request: the base could be produced with outdoor resistant special paint applications. Powder coated (mat): **White, Anthracite, Black**

X-TREME-S WOX With beech wood leg

SEAT: PC GLOSSY FINISH (TRANSPARENT) COLOURS

- 29 Red
- 33 Orange
- 35 Green
- 37 Clear
- 38 Smoke
- 40 Blue

SEAT: PC GLOSSY FINISH (SOLID) COLOURS

- 42 Black
- 43 White
- 44 Red

WOODEN LEG FINISHES

- Natural beech wood
- Wenge lacquered beech wood
- Black lacquered beech wood
- White lacquered beech wood

METAL STRAPS FINISHES

- Anthracite

On request the strap could be produced in with white (mat) finish. For not standards colours please check the price and delivery time.

X-TREME-S WOX With iroko wood leg

SEAT: PC GLOSSY FINISH (TRANSPARENT) COLOURS

- 29 Red
- 33 Orange
- 35 Green
- 37 Clear
- 38 Smoke
- 40 Blue

SEAT: PC GLOSSY FINISH (SOLID) COLOURS

- 42 Black
- 43 White
- 44 Red

WOODEN LEG FINISHES

- Natural iroko wood (with colour stabilized oil treatment) Due to the nature of the iroko wood colour tone may differ in each purchase.

METAL STRAPS FINISHES

- Anthracite

On request the strap could be produced in with white (mat) finish. For not standards colours please check the price and delivery time.

X-TREME BSL

SEAT: PC GLOSSY FINISH (TRANSPARENT) COLOURS

- 29 Red
- 33 Orange
- 35 Green
- 37 Clear
- 38 Smoke
- 40 Blue

SEAT: PC GLOSSY FINISH (SOLID) COLOURS

- 42 Black
- 43 White
- 44 Red

FRAME COLOURS

- Chrome plated

on request: the base could be produced with outdoor resistant special paint applications. Powder coated (mat): **White, Anthracite, Black**

X-TREME BSS

SEAT: PC GLOSSY FINISH (TRANSPARENT) COLOURS

- 29 Red
- 33 Orange
- 35 Green
- 37 Clear
- 38 Smoke
- 40 Blue

SEAT: PC GLOSSY FINISH (SOLID) COLOURS

- 42 Black
- 43 White
- 44 Red

FRAME COLOURS

- Chrome plated

on request: the base could be produced with outdoor resistant special paint applications. Powder coated (mat): **White, Anthracite, Black**

X-TREME SLED

SEAT: PC GLOSSY FINISH (TRANSPARENT) COLOURS

- 29 Red
- 33 Orange
- 35 Green
- 37 Clear
- 38 Smoke
- 40 Blue

SEAT: PC GLOSSY FINISH (SOLID) COLOURS

- 42 Black
- 43 White
- 44 Red

FRAME COLOURS

- Chrome plated

on request: the base could be produced with outdoor resistant special paint applications. Powder coated (mat): **White, Anthracite, Black**

X-TREME B

SEAT: PC GLOSSY FINISH (TRANSPARENT) COLOURS

- 29 Red
- 33 Orange
- 35 Green
- 37 Clear
- 38 Smoke
- 40 Blue

SEAT: PC GLOSSY FINISH (SOLID) COLOURS

- 42 Black
- 43 White
- 44 Red

FRAME COLOURS

- Chrome plated

X-TREME BENCH With 2 seater & compact side table

SEAT: PC GLOSSY FINISH (TRANSPARENT) COLOURS

- 29 Red
- 33 Orange
- 35 Green
- 37 Clear
- 38 Smoke
- 40 Blue

SEAT: PC GLOSSY FINISH (SOLID) COLOURS

- 42 Black
- 43 White
- 44 Red

TABLE: COMPACT COLOURS

- 1049M Black
- 1050M White

FRAME COLOURS

- Chrome plated
- Anthracite powder coated
- Black powder coated
- White powder coated

X-TREME BENCH With 3 seater

SEAT: PC GLOSSY FINISH (TRANSPARENT) COLOURS

- 29 Red
- 33 Orange
- 35 Green
- 37 Clear
- 38 Smoke
- 40 Blue

SEAT: PC GLOSSY FINISH (SOLID) COLOURS

- 42 Black
- 43 White
- 44 Red

FRAME COLOURS

- Chrome plated
- Anthracite powder coated
- Black powder coated
- White powder coated

X-TREME BENCH With 3 seater & compact side table

SEAT: PC GLOSSY FINISH (TRANSPARENT) COLOURS

- 29 Red
- 33 Orange
- 35 Green
- 37 Clear
- 38 Smoke
- 40 Blue

SEAT: PC GLOSSY FINISH (SOLID) COLOURS

- 42 Black
- 43 White
- 44 Red

TABLE: COMPACT COLOURS

- 1049M Black
- 1050M White

FRAME COLOURS

- Chrome plated
- Anthracite powder coated
- Black powder coated
- White powder coated

X-TREME BENCH With 4 seater

SEAT: PC GLOSSY FINISH (TRANSPARENT) COLOURS

- 29 Red
- 33 Orange
- 35 Green
- 37 Clear
- 38 Smoke
- 40 Blue

SEAT: PC GLOSSY FINISH (SOLID) COLOURS

- 42 Black
- 43 White
- 44 Red

FRAME COLOURS

- Chrome plated
- Anthracite powder coated
- Black powder coated
- White powder coated

X-TREME BENCH With 4 seater & compact side table

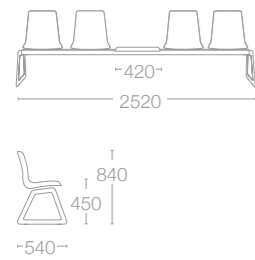

- SEAT: PC GLOSSY FINISH (TRANSPARENT) COLOURS
- 29 Red
  - 33 Orange
  - 35 Green
  - 37 Clear
  - 38 Smoke
  - 40 Blue
- SEAT: PC GLOSSY FINISH (SOLID) COLOURS
- 42 Black
  - 43 White
  - 44 Red
- TABLE: COMPACT COLOURS
- 1049M Black
  - 1050M White
- FRAME COLOURS
- Chrome plated
  - Anthracite powder coated
  - Black powder coated
  - White powder coated

X-TREME-S PRO

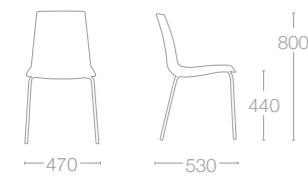

- SEAT: PP FINISH COLOURS
- 01 White
  - 09 Black
  - 22 Anthracite
  - 51 Brick Red
  - 52 Dark Yellow
  - 61 Taupe
  - 69 Reseda Green
- FRAME COLOURS
- Chrome plated
- on request: the base could be produced with outdoor resistant special paint applications. Powder coated (mat): **White, Anthracite, Black**

X-TREME-S WOX PRO With beech wood leg

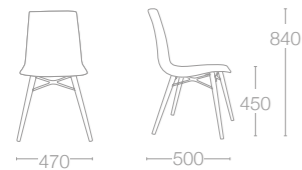

- SEAT: PP FINISH COLOURS
- 01 White
  - 09 Black
  - 22 Anthracite
  - 51 Brick Red
  - 52 Dark Yellow
  - 61 Taupe
  - 69 Reseda Green
- WOODEN LEG FINISHES
- Natural beech wood
  - Wenge lacquered beech wood
  - Black lacquered beech wood
  - White lacquered beech wood
- METAL STRAPS FINISHES
- Anthracite
- On request the strap could be produced in with white (mat) finish. For not standards colours please check the price and delivery time.

X-TREME-S WOX PRO With iroko wood leg

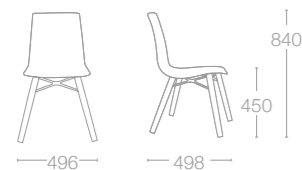

- SEAT: PP FINISH COLOURS
- 01 White
  - 09 Black
  - 22 Anthracite
  - 51 Brick Red
  - 52 Dark Yellow
  - 61 Taupe
  - 69 Reseda Green
- WOODEN LEG FINISHES
- Natural iroko wood (with colour stabilized oil treatment) Due to the nature of the iroko wood colour tone may differ in each purchase.
- METAL STRAPS FINISHES
- Anthracite
- On request the strap could be produced in with white (mat) finish. For not standards colours please check the price and delivery time.

X-TREME BSL PRO

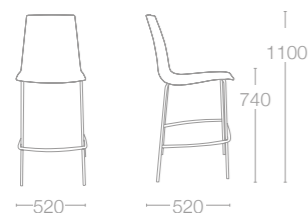

- SEAT: PP FINISH COLOURS
- 01 White
  - 09 Black
  - 22 Anthracite
  - 51 Brick Red
  - 52 Dark Yellow
  - 61 Taupe
  - 69 Reseda Green
- FRAME COLOURS
- Chrome plated
- on request: the base could be produced with outdoor resistant special paint applications. Powder coated (mat): **White, Anthracite, Black**

X-TREME BSS PRO

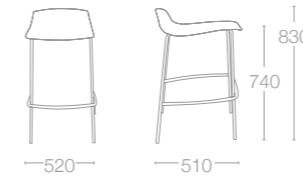

- SEAT: PP FINISH COLOURS
- 01 White
  - 09 Black
  - 22 Anthracite
  - 51 Brick Red
  - 52 Dark Yellow
  - 61 Taupe
  - 69 Reseda Green

- FRAME COLOURS
- Chrome plated
- on request: the base could be produced with outdoor resistant special paint applications. Powder coated (mat): **White, Anthracite, Black**

X-TREME SLED PRO

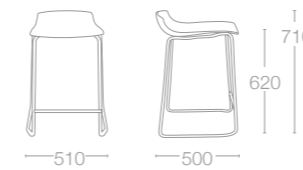

- SEAT: PP FINISH COLOURS
- 01 White
  - 09 Black
  - 22 Anthracite
  - 51 Brick Red
  - 52 Dark Yellow
  - 61 Taupe
  - 69 Reseda Green

- FRAME COLOURS
- Chrome plated
- on request: the base could be produced with outdoor resistant special paint applications. Powder coated (mat): **White, Anthracite, Black**

X-TREME B PRO



- SEAT: PP FINISH COLOURS
- 01 White
  - 09 Black
  - 22 Anthracite
  - 51 Brick Red
  - 52 Dark Yellow
  - 61 Taupe
  - 69 Reseda Green

- FRAME COLOURS
- Chrome plated

X-TREME BENCH PRO With 2 seater & compact side table

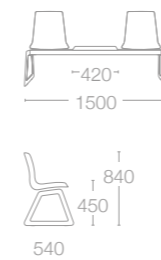

- SEAT: PP FINISH COLOURS
- 01 White
  - 09 Black
  - 22 Anthracite
  - 51 Brick Red
  - 52 Dark Yellow
  - 61 Taupe
  - 69 Reseda Green

- TABLE: COMPACT COLOURS
- 1049M Black
  - 1050M White
- FRAME COLOURS
- Chrome plated
  - Anthracite powder coated
  - Black powder coated
  - White powder coated

X-TREME BENCH PRO With 3 seater

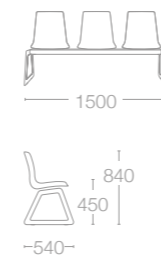

- SEAT: PP FINISH COLOURS
- 01 White
  - 09 Black
  - 22 Anthracite
  - 51 Brick Red
  - 52 Dark Yellow
  - 61 Taupe
  - 69 Reseda Green

- FRAME COLOURS
- Chrome plated
  - Anthracite powder coated
  - Black powder coated
  - White powder coated



X-TREME BENCH PRO With 3 seater & compact side table

SEAT: PP FINISH COLOURS

- 01 White
- 09 Black
- 22 Anthracite
- 51 Brick Red
- 52 Dark Yellow
- 61 Taupe
- 69 Reseda Green

TABLE: COMPACT COLOURS

- 1049M Black
- 1050M White

FRAME COLOURS

- Chrome plated
- Anthracite powder coated
- Black powder coated
- White powder coated

X-TREME BENCH PRO With 4 seater

SEAT: PP FINISH COLOURS

- 01 White
- 09 Black
- 22 Anthracite
- 51 Brick Red
- 52 Dark Yellow
- 61 Taupe
- 69 Reseda Green

FRAME COLOURS

- Chrome plated
- Anthracite powder coated
- Black powder coated
- White powder coated

X-TREME BENCH PRO With 4 seater & compact side table

SEAT: PP FINISH COLOURS

- 01 White
- 09 Black
- 22 Anthracite
- 51 Brick Red
- 52 Dark Yellow
- 61 Taupe
- 69 Reseda Green

TABLE: COMPACT COLOURS

- 1049M Black
- 1050M White

FRAME COLOURS

- Chrome plated
- Anthracite powder coated
- Black powder coated
- White powder coated

FLORA CHIEF

SEAT: PC MATT FINISH COLOURS

- 01C White
- 09C Black
- 22C Anthracite
- 51C Brick Red

SEAT: PC GLOSSY FINISH (TRANSPARENT) COLOURS

- 28 Purple
- 29 Red
- 37 Clear
- 38 Smoke
- 40 Blue
- 50 Light Orange

SEAT: PC GLOSSY FINISH (SOLID) COLOURS

- 43 White

FRAME COLOURS

- Chrome plated

GYZA

PC GLOSSY FINISH (TRANSPARENT) COLOURS

- 29 Red
- 33 Orange
- 35 Green
- 37 Clear
- 38 Smoke
- 40 Blue

PC GLOSSY FINISH (SOLID) COLOURS

- 42 Black
- 43 White
- 44 Red

CLASS-X

CLASS-X COLLECTION

PC GLOSSY FINISH (TRANSPARENT) COLOURS

- 37 Clear
- 38 Smoke
- 39 Amber

PC GLOSSY FINISH (SOLID) COLOURS

- 42 Black
- 43 White

CLASS-XC

PC GLOSSY FINISH (TRANSPARENT) COLOURS

- 37 Clear
- 38 Smoke

FLORA COLLECTION

FLORA-PP

FULLY: PP AND PC MAT FINISH COLOURS

- 01C White
- 09C Black
- 22C Anthracite
- 51C Brick Red

SEAT: PC GLOSSY FINISH (TRANSPARENT) COLOURS

- 28 Purple
- 29 Red
- 37 Clear
- 38 Smoke
- 40 Blue
- 50 Light Orange

SEAT: PC GLOSSY FINISH (SOLID) COLOURS

- 43 White

LEGS: PP FINISH COLOURS

- 01 White
- 09C Black
- 22 Anthracite

FLORA-ML

SEAT: PC MATT FINISH COLOURS

- 01C White
- 09C Black
- 22C Anthracite
- 51C Brick Red

SEAT: PC GLOSSY FINISH (TRANSPARENT) COLOURS

- 28 Purple
- 29 Red
- 37 Clear
- 38 Smoke
- 40 Blue
- 50 Light Orange

SEAT: PC GLOSSY FINISH (SOLID) COLOURS

- 43 White

FRAME COLOURS

- Chrome plated

on request: the base could be produced with outdoor resistant special paint applications. Powder coated (mat): White, Anthracite, Black

EDEN COLLECTION

EDEN-S

PP MAT FINISH COLOURS

- 51C Brick Red
- 53C Dark Brown

PP FINISH COLOURS

- 01 White
- 17 Warm grey
- 52 Dark Yellow
- 61 Taupe

EDEN COLLECTION

EDEN-K

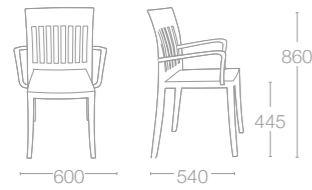

PP MAT FINISH COLOURS  
 51C Brick Red  
 53C Dark Brown

PP FINISH COLOURS  
 01 White  
 17 Warm grey  
 52 Dark Yellow  
 61 Taupe

MAMBO

MAMBO

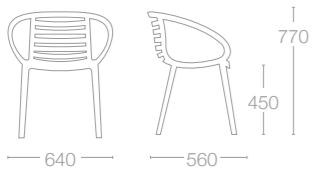

PP FINISH COLOURS  
 01 White  
 18 Brown  
 22 Anthracite  
 61 Taupe

COOL

COOL

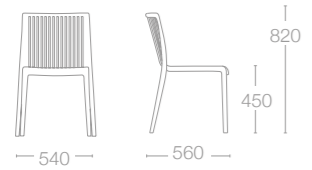

PP FINISH COLOURS  
 01 White  
 04 Red  
 22 Anthracite  
 23 Purple  
 24 Green  
 25 Blue  
 61 Taupe

NOSTA

NOSTA-S

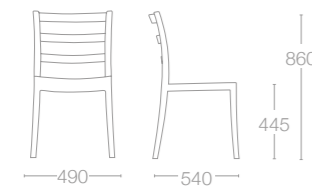

PP FINISH COLOURS  
 01 White  
 17 Warm grey  
 22 Anthracite  
 61 Taupe  
 70 Aqua Blue

VARIA

VARIA-S

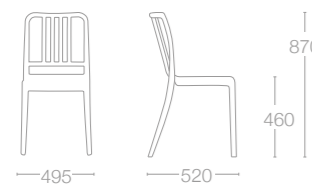

PP MAT FINISH COLOURS  
 04C Red  
 22C Anthracite

PP FINISH COLOURS  
 01 White  
 04 Red  
 17 Warm grey  
 22 Anthracite  
 54 Lime Green  
 61 Taupe  
 65 Sandy Beige

YUMMY

YUMMY

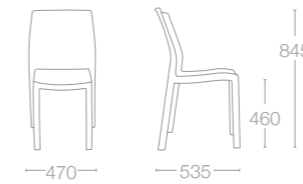

PP FINISH COLOURS  
 01 White  
 04 Red  
 05 Dark Green  
 09 Black  
 13 Teak  
 72 Orange  
 21 Ivory

TIARA

TIARA

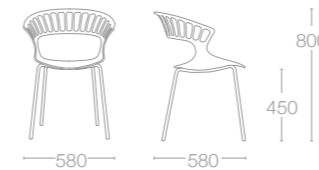

SEAT: PP FINISH COLOURS  
 01 White  
 04 Red  
 22 Anthracite  
 23 Purple

FRAME COLOURS  
 Chrome plated  
 Anthracite powder coated  
 White powder coated

ICON COLLECTION

ICON-S

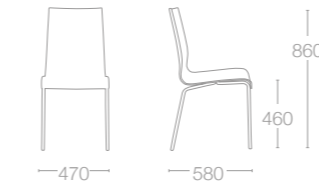

SEAT: PP FINISH COLOURS  
 01 White  
 04 Red  
 09 Black  
 21 Ivory  
 22 Anthracite

FRAME COLOURS  
 Chrome plated  
 Silver metallic

ICON-B

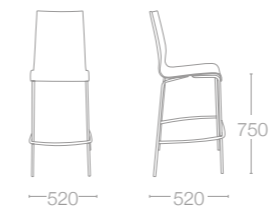

SEAT: PP FINISH COLOURS  
 01 White  
 04 Red  
 09 Black  
 21 Ivory  
 22 Anthracite

FRAME COLOURS  
 Chrome plated  
 Silver metallic

ICON-K



SEAT: PP FINISH COLOURS  
 01 White  
 04 Red  
 09 Black  
 21 Ivory  
 22 Anthracite

FRAME COLOURS  
 Chrome plated

VITAL COLLECTION

VITAL-S

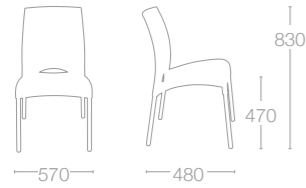

SEAT: PP FINISH COLOURS

- 21 Ivory
- 72 Orange

FRAME COLOURS

- Satin Anodized Aluminium

VITAL-K

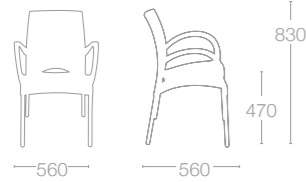

SEAT: PP FINISH COLOURS

- 01 White
- 09 Black
- 21 Ivory

FRAME COLOURS

- Satin Anodized Aluminium

MARVEL-S

MARVEL-S

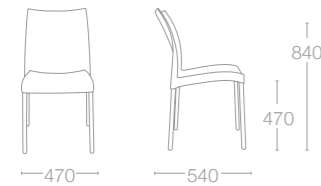

SEAT: PP FINISH COLOURS

- 04 Red
- 09 Black
- 12 Light Green
- 21 Ivory
- 72 Orange

FRAME COLOURS

- Satin Anodized Aluminium

KAREA

KAREA

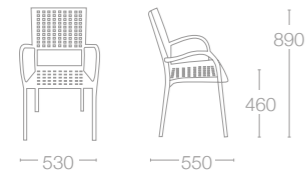

SEAT: PP FINISH COLOURS

- 01 White
- 04 Red
- 05 Dark Green
- 09 Black
- 12 Light Green
- 13 Teak
- 16 Orange

FRAME COLOURS

- Satin Anodized Aluminium

WAVE COLLECTION

WAVE SUNLOUNGER

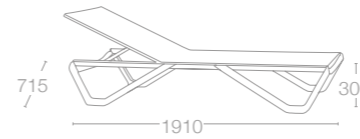

BASE: PP FINISH COLOURS

- 01 White
- 22 Anthracite
- 61 Taupe

FABRIC COLOURS (STOCK COLOURS)

- 5001 White
- 5347 Turquoise
- 5700 Anthracite
- 50070 Taupe

FABRIC COLOURS (NON STOCK COLOURS)

- 5017 Yellow
- 5374 Grey
- 5336 Pink
- 5329 Orange
- 5367 Green
- 5009 Blue

\*Check production time for non stock colours.

FRAME COLOURS

- Satin anodized aluminium

WAVE SIDE TABLE

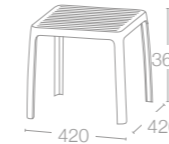

PP FINISH COLOURS

- 01 White
- 22 Anthracite
- 61 Taupe

ZEN COLLECTION

ZEN SUNLOUNGER

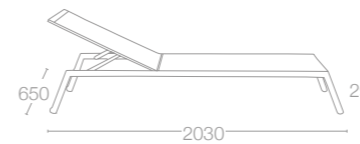

FABRIC COLOURS

- 5001 White
- 5700 Anthracite
- 50070 Taupe

FRAME COLOURS

- Stainless steel

ZEN SIDE TABLE

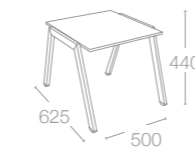

COMPACT TABLE TOP COLOURS

- 1050M White
- 1049M Black

FRAME COLOURS

- Stainless steel

PP FINISH COLOURS



PP MATT FINISH COLOURS

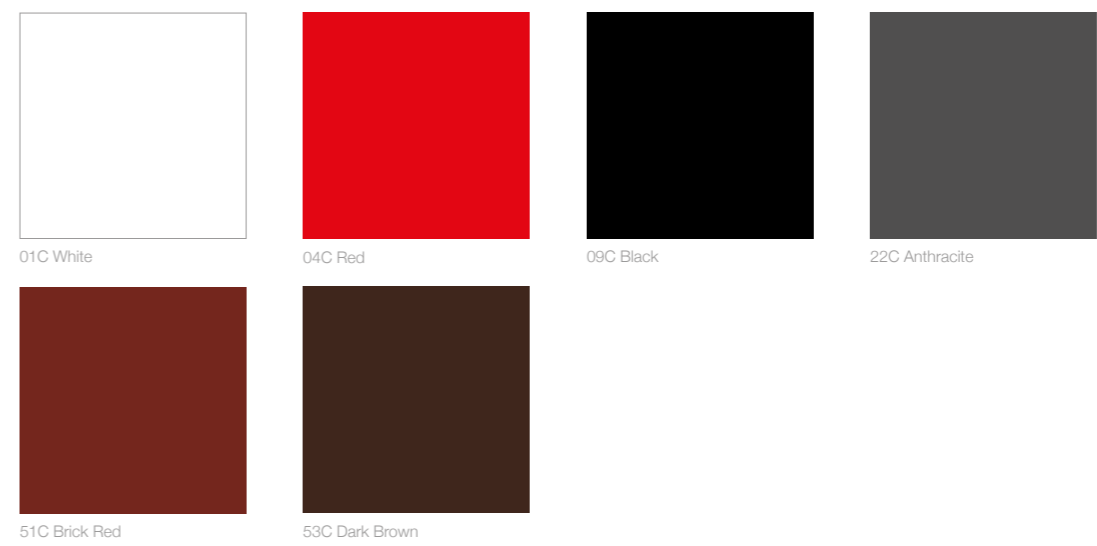

## CHAIRS AND STOOLS COLOURS

### PC GLOSSY FINISH (TRANSPARENT) COLOURS



28 Purple



29 Red



33 Orange



35 Green



37 Clear



38 Smoke



39 Amber



40 Blue



50 Light Orange

### PC GLOSSY FINISH (SOLID) COLOURS

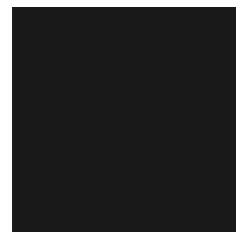

42 Black



43 White



44 Red

### PC MAT FINISH COLOURS



01C White



09C Black



22C Anthracite

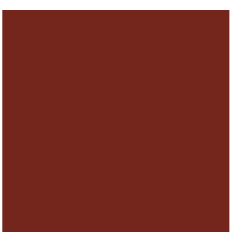

51C Brick Red

## COVER TYPES AND COLOURS

### LEATHER COLOURS



Genetic



001 White



901 Black



027 Beige



260 Red



342 Brown



Capitone



003 White



009 Black

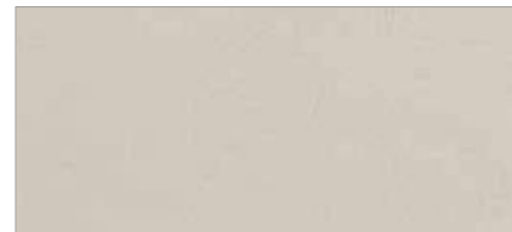

Artificial leather



60 Red



61 Black



62 Brown

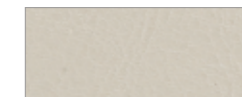

63 Ivory

### ANTELOP AND PANDORA FABRIC COVER COLOURS



Antelop



117 Green



402 Red



801 Black



722 Grey



Pandora



308 Beige



800 Black

## CHAIRS AND STOOLS COLOURS

### LINEN FABRIC COVER COLOURS

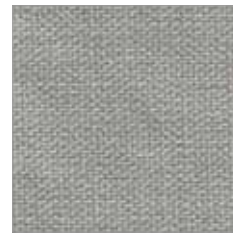

linen fabric cover



1001 Dark beige



1009 Red \*



1022 Orange \*



1026 Yellow \*



1053 Grey \*



1006 Anthracite \*



1012 Lime green \*

### STAMSKIN ZEN FABRIC COVER COLOURS

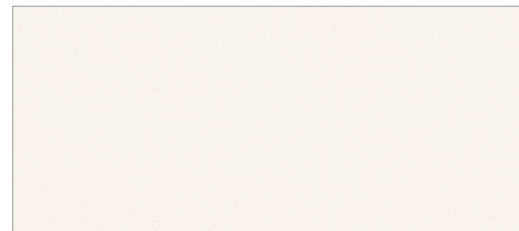

Stamskin Zen Fabric



120 White



151 Brown



158 Orange



349 Purple



159 Green



161 Grey



153 Black

### STAMSKIN FABRIC COVER COLOURS



Eden fabric cover



566 Light Grey



555 Anthracite



563 Beige

### BATYLINE ISO COLOURS (only for sunloungers)



Batyline Iso



5001 White



50070 Taupe



5700 Anthracite



5347 Turquoise



5017 Yellow \*



5009 Blue \*



5336 Pink \*



5374 Grey \*



5329 Orange \*



5367 Green \*

PAPATYA®

TABLES

WOX COLLECTION

WOX beech legs

- WOODEN LEG FINISHES
- Natural beech wood
  - Wenge lacquered beech wood
  - Black lacquered beech wood
  - White lacquered beech wood

- METAL STRAP FINISHES
- Anthracite

On request the strap could be produced in **white or black** (mat) finish. For non standarts colours please check the prices and delivery time.

AVAILABLE TOP COLOURS  
1050M, 1049M, 3039M, 1049WGR1, 3120M, 3167M, 5101STN, 5054M, 5056M

Solid laminate compact top colours on page 236  
Except white, other colours are recommended only in shaded areas

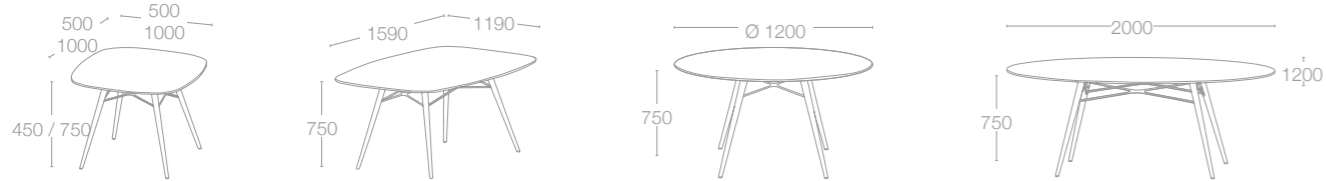

SIZE	LEGS	TOP INCLUDED (12MM)	Kg.
1000 x 1000 x H. 750	Ø 32 wood leg	✓	Kg 19,2
1190 x 1590 x H. 750	Ø 32 wood leg	✓	Kg 34,4
Ø 1200 x H. 750	Ø 32 wood leg	✓	Kg 22,9
1200 x 2000 x H. 750	Ø 32 wood leg	✓	Kg 34,1
500 x 500 x H. 450	Ø 32 wood leg	✓	Kg 6

WOX iroko legs

- WOODEN LEG FINISHES
- Natural iroko wood

(with colour stabilized oil treatment) Due to the nature of the iroko wood colour tone may differ in each purchase.

- Anthracite

On request the strap could be produced in (mat) finish. For non standarts colours please check the prices and delivery time.

AVAILABLE TOP COLOURS  
1050M, 1049M, 3039M, 1049WGR1, 3120M, 3167M, 5101STN, 5054M, 5056M

Solid laminate compact top colours on page 236  
Except white, other colours are recommended only in shaded areas



SIZE	LEGS	TOP INCLUDED (12MM)	Kg.
1000 x 1000 x H. 750	30 x 30 wood leg	✓	Kg 19,2
1190 x 1590 x H. 750	30 x 30 wood leg	✓	Kg 34,4
Ø 1200 x H. 750	30 x 30 wood leg	✓	Kg 22,9
1200 x 2000 x H. 750	30 x 30 wood leg	✓	Kg 34,1
500 x 500 x H. 450	30 x 30 wood leg	✓	Kg 6

MAXIMA

MAXIMA

- chrome plated

- Powder coated (mat) strengthened against rusting and scratches with cataphoresis application.
- RAL 9016 White
  - RAL 7016 Anthracite
  - RAL 9005 Black
  - RAL 1019 Taupe

AVAILABLE TOP COLOURS  
1050M, 1049M, 3039M

Solid laminate compact top colours on page 236  
Except white, other colours are recommended only in shaded areas

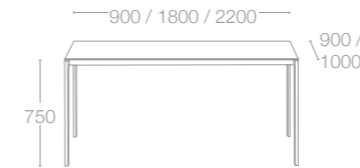

SIZE	FRAME	TOP INCLUDED (12MM)	Kg.
900 x 900 x H. 750	50 x 50	✓	Kg 34,5
1800 x 900 x H. 750	50 x 50	✓	Kg 53,5
2200 x 1000 x H. 750	50 x 50	✓	Kg 67

OPUS

OPUS with polymer laminate top (18 mm) or solid laminate top (12 mm)

- FRAME FINISH
- satin anodized aluminium

AVAILABLE TOP FINISHES

POLYMER LAMINATE MDF TOP COLOURS:  
74 Gold, 76 yellow, 77 Black, 79 Pear, 81 Cream, 83 White, 84 Grey, 86 D. walnut, 87 Maple, 89 Wenge, 90 Claret, 91 orange, 93 Walnut, 96 Cherry, 99 D. cherry

SOLID LAMINATE COMPACT TOP COLOURS:  
1050M, 1049M, 3039M

Polymer laminate mdf top colours on page 237  
Solid laminate compact top colours on page 236  
Except white, other colours are recommended only in shaded areas

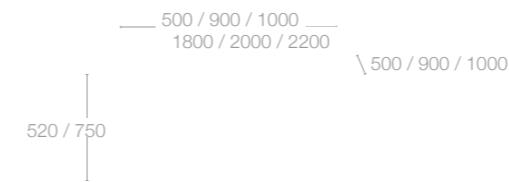

SIZE	FRAME	TOP INCLUDED	Kg.
900 x 900 x H. 750	50 x 50	✓	Kg 19,5 (mdf) Kg 23 (compact)
900 x 1800 x H. 750	50 x 50	✓	Kg 33 (mdf) Kg 39 (compact)
1000 x 2000 x H. 750	50 x 50	✓	Kg 38,5 (mdf) Kg 46 (compact)
1000 x 2200 x H. 750	50 x 50	✓	Kg 41,5 (mdf) Kg 50 (compact)
500 x 500 x H. 520	50 x 50	✓	Kg 10,5 (mdf) Kg 11 (compact)
500 x 1000 x H. 520	50 x 50	✓	Kg 14 (mdf) Kg 16 (compact)

**IDEA** IDEA with polymer laminate top (18 mm) or solid laminate top (12 mm)



SIZE	FRAME	TOP INCLUDED	Kg.
800 x 800 x H. 750	40 x 40	✓	Kg 21,5 (mdf) Kg 23 (compact)
800 x 1200 x H. 750	40 x 40	✓	Kg 23,5 (mdf) Kg 26,5 (compact)
800 x 1400 x H. 750	40 x 40	✓	Kg 30,5 (mdf) Kg 34,5 (compact)
500 x 500 x H. 520	40 x 40	✓	Kg 9,5 (mdf) Kg 10 (compact)
500 x 1000 x H. 520	40 x 40	✓	Kg 13,5 (mdf) Kg 15,5 (compact)

AVAILABLE TOP FINISHES

POLYMER LAMINATE MDF TOP COLOURS:  
74 Gold, 76 yellow, 77 Black, 79 Pear, 81 Cream, 83 White, 84 Grey, 86 D. walnut, 87 Maple, 89 Wenge, 90 Claret, 91 orange, 93 Walnut, 96 Cherry, 99 D. cherry

SOLID LAMINATE COMPACT TOP COLOURS:  
1050M, 1049M, 3039M

Polymer laminate mdf top colours on page 237  
Solid laminate compact top colours on page 236  
Except white, other colours are recommended only in shaded areas

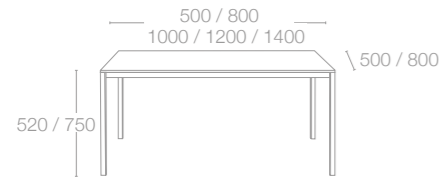

**SLIM** SLIM with polymer laminate top (18 mm), solid laminate top (12 mm)

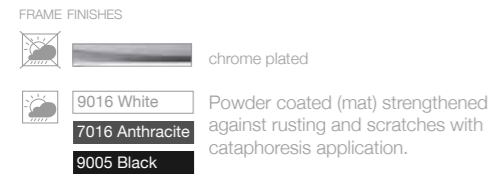

SIZE	FRAME	TOP INCLUDED	Kg.
800 x 800 x H. 750	30 x 30	✓	Kg 21,5 (mdf) Kg 24 (compact)
800 x 1200 x H. 750	30 x 30	✓	Kg 27,5 (mdf) Kg 30 (compact)
800 x 1400 x H. 750	30 x 30	✓	Kg 30,5 (mdf) Kg 33,5 (compact)
900 x 1800 x H. 750	30 x 30	✓	Kg 38 (mdf) Kg 44 (compact)
500 x 500 x H. 520	30 x 30	✓	Kg 12 (mdf) Kg 13 (compact)
500 x 1000 x H. 520	30 x 30	✓	Kg 17 (mdf) Kg 19 (compact)

AVAILABLE TOP FINISHES

POLYMER LAMINATE MDF TOP COLOURS:  
74 Gold, 76 yellow, 77 Black, 79 Pear, 81 Cream, 83 White, 84 Grey, 86 D. walnut, 87 Maple, 89 Wenge, 90 Claret, 91 orange, 93 Walnut, 96 Cherry, 99 D. cherry

SOLID LAMINATE COMPACT TOP COLOURS:  
1050M, 1049M, 3039M

Polymer laminate mdf top colours on page 237  
Solid laminate compact top colours on page 236  
Except white, other colours are recommended only in shaded areas

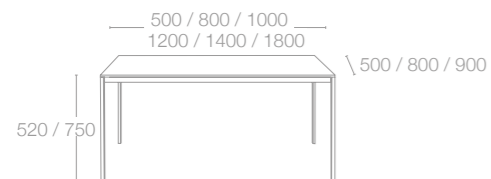

**ONIX** ONIX round with solid laminate top (12 mm)

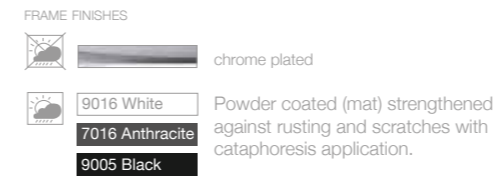

SIZE	BASE	TOP INCLUDED	Kg.
Ø 1200 x H. 750	Ø 600	✓	Kg 41,5 (compact)
Ø 1390 x H. 750	Ø 600	✓	Kg 62,5 (compact)
Ø 1590 x H. 750	Ø 900	✓	Kg 70,9 (compact)

AVAILABLE TOP COLOURS  
1050M, 1049M, 3039M, 1049WGR1, 3120M, 3167M, 5101STN, 5054M, 5056M

Ø 1590 x H. 750 AVAILABLE ONLY IN COMPACT TABLE TOP COLOURS: 1050M, 1049M, 3039M

Solid laminate compact top colours on page 236  
Except white, other colours are recommended only in shaded areas

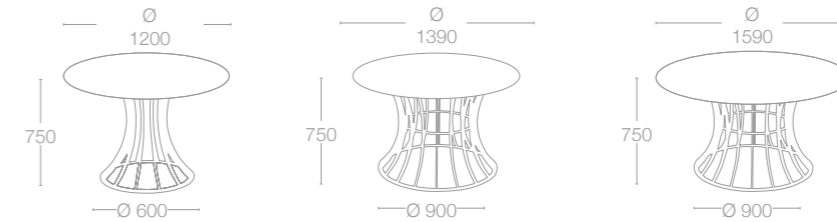

**TRIO** TRIO DOUBLE with solid laminate top (12 mm)

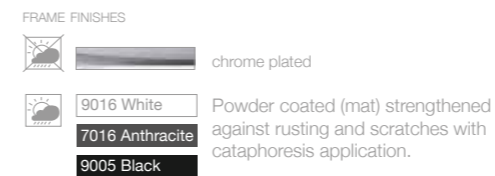

SIZE	BASE	TOP INCLUDED	Kg.
900 x 1800 x H. 750	450 x 450 (x2)	✓	Kg 41 (compact)
1000 x 2000 x H. 750	450 x 450 (x2)	✓	Kg 48,5 (compact)
1000 x 2200 x H. 750	450 x 450 (x2)	✓	Kg 52 (compact)

AVAILABLE TOP FINISHES  
1050M, 1049M, 3039M

Solid laminate compact top colours on page 236  
Except white, other colours are recommended only in shaded areas

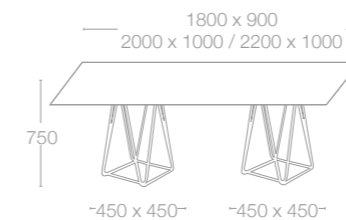



# TABLE BASES

PLUS COLLECTION

**PLUS**

With adjustable foot

BASE FINISH

- 9016 White
- 7016 Anthracite
- 9005 Black
- 1019 Taupe

Powder coated (mat) strengthened against rusting and scratches with cataphoresis application.

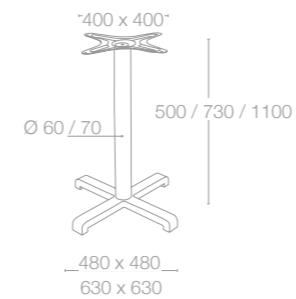

MODEL	BASE	FEET	TOP SUPPORT	APPLICABLE TABLE TOP MAXIMUM RECOMENDED SIZE	Kg.
480 x 480 table base	480 x 480	H. 730 Ø 60	400 x 400	square 700 x 700 round Ø 700	Kg. 4,95
480 x 480 side table base	480x480	H.500 Ø 60	400x400	square 700x700 round Ø 700	Kg. 5,00
630 x 630 table base	630 x 630	H. 730 Ø 70	400 x 400	square 800 x 800 round Ø 800	Kg. 5,95
630 x 630 bar table base	630 x 630	H. 1100 Ø 70	400 x 400	square 700 x 700 round Ø 700	Kg. 7,00

PLUS COLLECTION

**PLUS II**

With adjustable foot

BASE FINISH

- 9016 White
- 7016 Anthracite
- 9005 Black
- 1019 Taupe

Powder coated (mat) strengthened against rusting and scratches with cataphoresis application.

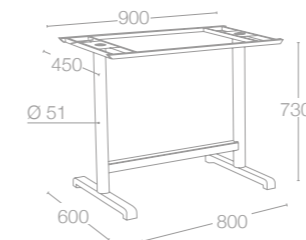

MODEL	BASE	FEET	TOP SUPPORT	APPLICABLE TABLE TOP MAXIMUM RECOMENDED SIZE	Kg.
600 x 800 table base	600 x 800	H. 730 Ø 51	450 x 900	800 x 1400	Kg. 11

**KROSS**

With adjustable foot

BASE FINISH 

- 9016 White
- 7016 Anthracite
- 9005 Black

Powder coated (mat) strengthened against rusting and scratches with cataphoresis application.

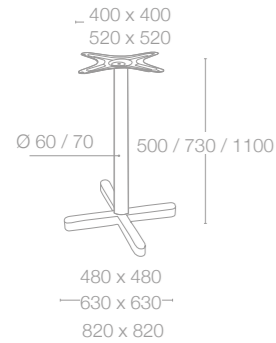

MODEL	BASE	FEET	TOP SUPPORT	APPLICABLE TABLE TOP MAXIMUM RECOMENDED SIZE	Kg.
480 x 480 table base	480 x 480	H. 730 Ø 60	400 x 400	square 700 x 700 round Ø 700	Kg. 6
480 x 480 side table base	480 x 480	H. 500 Ø 60	400 x 400	square 700 x 700 round Ø 700	Kg. 5
630 x 630 table base	630 x 630	H. 730 Ø 70	400 x 400	square 800 x 800 round Ø 800	Kg. 6,5
630 x 630 bar table base	630 x 630	H. 1100 Ø 70	400 x 400	square 700 x 700 round Ø 700	Kg. 7,5
820 x 820 table base	820 x 820	H. 730 Ø 70	520 x 520	square 900 x 900 round Ø 1000	Kg. 6,5

**KROSS II**

With adjustable foot

BASE FINISH 

- 9016 White
- 7016 Anthracite
- 9005 Black

Powder coated (mat) strengthened against rusting and scratches with cataphoresis application.

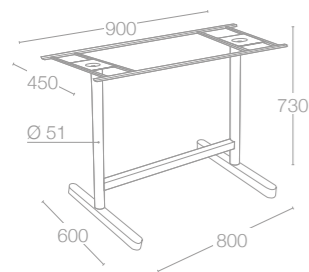

MODEL	BASE	FEET	TOP SUPPORT	APPLICABLE TABLE TOP MAXIMUM RECOMENDED SIZE	Kg.
600 x 800 table base	600 x 800	H. 730 Ø 51	450 x 900	800 x 1400	Kg. 11

**OXO I**

With adjustable foot

BASE FINISH 

- 9016 White
- 7016 Anthracite
- 9005 Black

Powder coated (mat) strengthened against rusting and scratches with cataphoresis application.

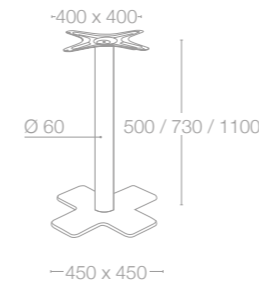

MODEL	BASE	FEET	TOP SUPPORT	APPLICABLE TABLE TOP MAXIMUM RECOMENDED SIZE	Kg.
450 x 450 table base	450 x 450	H. 730 Ø 60	400 x 400	square 700 x 700 round Ø 800	Kg. 10,5
450 x 450 bar table base	450 x 450	H. 1100 Ø 60	400 x 400	square 600 x 600 round Ø 600	Kg. 11,5
450 x 450 side table base	450 x 450	H. 500 Ø 60	400 x 400	square 700 x 700 round Ø 800	Kg. 9,5

**OXO II**

With adjustable foot

BASE FINISH 

- 9016 White
- 7016 Anthracite
- 9005 Black

Powder coated (mat) strengthened against rusting and scratches with cataphoresis application.

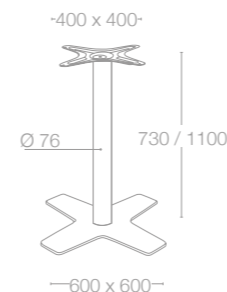

MODEL	BASE	FEET	TOP SUPPORT	APPLICABLE TABLE TOP MAXIMUM RECOMENDED SIZE	Kg.
600 x 600 table base	600 x 600	H. 730 Ø 76	520 x 520	square 900 x 900 round Ø 900	Kg. 13
600 x 600 bar table base	600 x 600	H. 1100 Ø 76	400 x 400	square 700 x 700 round Ø 700	Kg. 14,5

LOTUS SQUARE

With adjustable foot

- BASE FINISH
- 9016 White
  - 7016 Anthracite
  - 9005 Black

Powder coated (mat) strengthened against rusting and scratches with cataphoresis application.

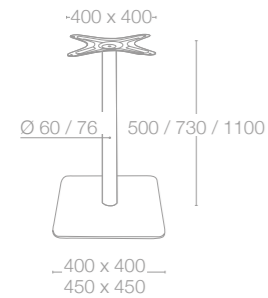

MODEL	BASE	FEET	TOP SUPPORT	APPLICABLE TABLE TOP MAXIMUM RECOMMENDED SIZE	Kg.
400 x 400 table base	400 x 400	H. 730 Ø 60	400 x 400	square 700 x 700 round Ø 800	Kg. 13,5
400 x 400 bar table base	400 x 400	H. 1100 Ø 60	400 x 400	square 600 x 600 round Ø 600	Kg. 14,5
400 x 400 side table base	400 x 400	H. 500 Ø 60	400 x 400	square 700 x 700 round Ø 800	Kg. 12,5
450 x 450 table base	450 x 450	H. 730 Ø 76	520 x 520	square 800 x 800 round Ø 900	Kg. 17
450 x 450 bar table base	450 x 450	H. 1100 Ø 76	400 x 400	square 700 x 700 round Ø 700	Kg. 17,5

LOTUS SQUARE

With adjustable foot

- BASE FINISH
- 9016 White
  - 7016 Anthracite
  - 9005 Black

Powder coated (mat) strengthened against rusting and scratches with cataphoresis application.

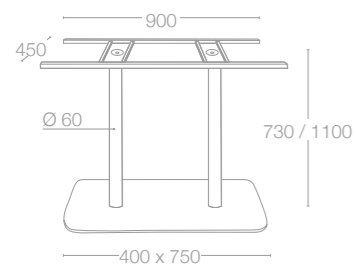

MODEL	BASE	FEET	TOP SUPPORT	APPLICABLE TABLE TOP MAXIMUM RECOMMENDED SIZE	Kg.
400 x 750 table base	400 x 750	H. 730 Ø 60	450 x 900	800 x 1400	Kg. 26,5
400 x 750 bar table base	400 x 750	H. 1100 Ø 60	450 x 900	700 x 1100	Kg. 28

LOTUS ROUND

With adjustable foot

- BASE FINISH
- 9016 White
  - 7016 Anthracite
  - 9005 Black

Powder coated (mat) strengthened against rusting and scratches with cataphoresis application.

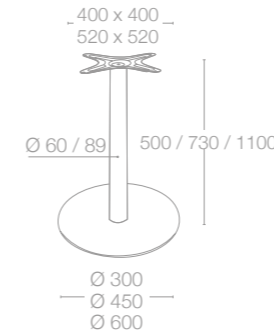

MODEL	BASE	FEET	TOP SUPPORT	APPLICABLE TABLE TOP MAXIMUM RECOMMENDED SIZE	Kg.
Ø 300 side table base	Ø 300	H. 500 Ø 60	400 x 400	square 700 x 700 round Ø 700	Kg. 7
Ø 450 table base	Ø 450	H. 730 Ø 60	400 x 400	square 800 x 800 round Ø 900	Kg. 13
Ø 450 bar table base	Ø 450	H. 1100 Ø 60	400 x 400	square 700 x 700 round Ø 700	Kg. 14
Ø 450 side table base	Ø 450	H. 500 Ø 60	400 x 400	square 800 x 800 round Ø 900	Kg. 12
Ø 600 table base	Ø 600	H. 730 Ø 89	520 x 520	square 900 x 900 round Ø 1200	Kg. 28

MODUS

With adjustable foot

- BASE FINISH (COORDINATE)
- | FEET              | BASE              |
|-------------------|-------------------|
| Brushed stainless | Brushed stainless |
| Chrome plated     | Brushed stainless |
| Silver metallic   | Brushed stainless |

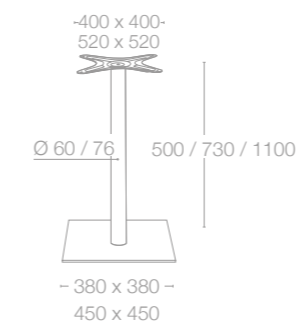

MODEL	BASE	FEET	TOP SUPPORT	APPLICABLE TABLE TOP MAXIMUM RECOMMENDED SIZE	Kg.
380 x 380 table base	380 x 380	H. 730 Ø 60	400 x 400	square 700 x 700 round Ø 800	Kg. 14,5
380 x 380 bar table base	380 x 380	H. 1100 Ø 60	400 x 400	square 700 x 700 round Ø 700	Kg. 15,5
380 x 380 side table base	380 x 380	H. 500 Ø 60	400 x 400	square 700 x 700 round Ø 700	Kg. 13,5
450 x 450 table base	450 x 450	H. 730 Ø 76	520 x 520	square 900 x 900 round Ø 1000	Kg. 17,5

MODUS II

With adjustable foot

BASE FINISH (COORDINATE)	
FEET	BASE
Brushed stainless	Brushed stainless
Chrome plated	Brushed stainless
Silver metallic	Brushed stainless

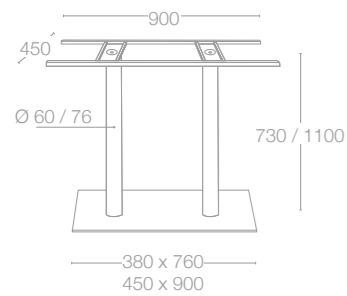

MODEL	BASE	FEET	TOP SUPPORT	APPLICABLE TABLE TOP MAXIMUM RECOMMENDED SIZE	Kg.
380 x 760 table base	380 x 760	H. 730 Ø 60	450 x 900	square 700 x 1100	Kg. 28
380 x 760 bar table base	380 x 760	H. 1100 Ø 60	450 x 900	square 700 x 1100	Kg. 30
450 x 900 table base	450 x 900	H. 730 Ø 76	450 x 900	square 800 x 1400	Kg. 35,5

PUNTO

With adjustable foot

BASE FINISH (COORDINATE)	
FEET	BASE
Brushed stainless	Brushed stainless
Chrome plated	Brushed stainless
Silver metallic	Brushed stainless

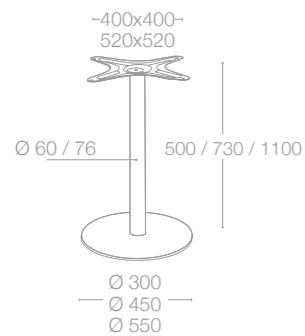

MODEL	BASE	FEET	TOP SUPPORT	APPLICABLE TABLE TOP MAXIMUM RECOMMENDED SIZE	Kg.
Ø 300 side table base	Ø 300	H. 500 Ø 60	400 x 400	square 700 x 700 round Ø 700	Kg. 8
Ø 450 table base	Ø 450	H. 730 Ø 60	400 x 400	square 800 x 800 round Ø 900	Kg. 14,5
Ø 450 bar table base	Ø 450	H. 1100 Ø 60	400 x 400	square 700 x 700 round Ø 700	Kg. 15
Ø 450 side table base	Ø 450	H. 500 Ø 60	400 x 400	square 700 x 700 round Ø 800	Kg. 13,5
Ø 550 table base	Ø 600	H. 730 Ø 76	520 x 520	square 900 x 900 round Ø 1100	Kg. 24

SPARK

SPARK

BASE FINISH	
9016 White	Powder coated (mat) strengthened against rusting and scratches with cataphoresis application.
7016 Anthracite	
9005 Black	

BASE FINISH	
chrome plated	

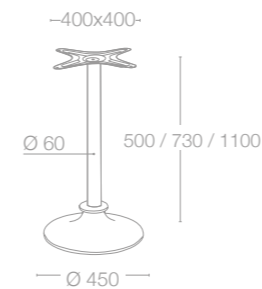

MODEL	BASE	FEET	TOP SUPPORT	APPLICABLE TABLE TOP MAXIMUM RECOMMENDED SIZE	Kg.
Ø 450 table base	Ø 450	H. 730 Ø 60	400 x 400	square 800 x 800 round Ø 900	Kg. 8,5
Ø 450 bar table base	Ø 450	H. 1100 Ø 60	400 x 400	square 700 x 700 round Ø 700	Kg. 9,5
Ø 450 side table base	Ø 450	H. 730 Ø 60	400 x 400	square 800 x 800 round Ø 900	Kg. 7,5

GAMA

GAMA

With adjustable foot

BASE FINISH	
Chrome plated	

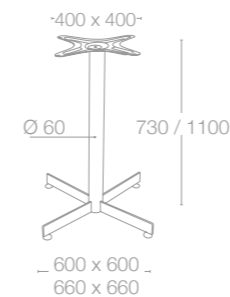

MODEL	BASE	FEET	TOP SUPPORT	APPLICABLE TABLE TOP MAXIMUM RECOMMENDED SIZE	Kg.
600 x 600 table base	600 x 600	H. 730 Ø 60	400 x 400	square 700 x 700 round Ø 800	Kg. 7,5
600 x 600 bar table base	600 x 600	H. 1100 Ø 60	400 x 400	square 700 x 700 round Ø 700	Kg. 8,5
660 x 660 table base	660 x 660	H. 730 Ø 60	400 x 400	square 800 x 800 round Ø 900	Kg. 8

EDGE TYPES:



SHAPE	SIZE	TOP TYPES			
		1050M - 1049M - 3039M	3120M - 3167M - 5054M - 5056M	5101STN	1049WGR1
Round	Ø 500	✓	✓	✓	✓
Round	Ø 600	✓	✓	✓	✓
Round	Ø 700	✓	—	—	—
Round	Ø 800	✓	—	—	—
Round	Ø 900	✓	—	—	—
Round	Ø 1000	✓	✓	✓	✓
Round	Ø 1200	✓	✓	✓	✓
Square	500 x 500	✓	✓	✓	✓
Square	600 x 600	✓	✓	✓	✓
Square	700 x 700	✓	—	—	—
Square	800 x 800	✓	—	—	—
Square	900 x 900	✓	—	—	—
Rectangular	500 x 1000	✓	—	—	—
Rectangular	700 x 1100	✓	—	—	—
Rectangular	800 x 1200	✓	—	—	—
Rectangular	800 x 1400	✓	—	—	—

Except white, other colours are recommended only in shades areas

Table top colours on page 236 - 237

On request: the table tops can be produced in other sizes and colours than indicated above. Please check with our team.

EDGE TYPES: flat edge

Shape	Size	TOP TYPES			
		1050M - 1049M - 3177M - 3167M - 3120M	5101M	5054M - 5056M	1049 WGR1
Round	Ø490	✓	✓	✓	✓
Round	Ø590	✓	✓	✓	✓
Round	Ø690	✓	✓	✓	✓
Round	Ø790	✓	✓	✓	✓
Round	Ø890	✓	✓	✓	✓
Round	Ø990	✓	✓	✓	✓
Round	Ø1190	✓	✓	✓	✓
Round	Ø1390	✓	✓	✓	—
Round	Ø1590	✓	✓	—	—
Square	490x490	✓	✓	✓	✓
Square	590x590	✓	✓	✓	✓
Square	690x690	✓	✓	✓	✓
Square	790x790	✓	✓	✓	✓
Square	890x890	✓	✓	✓	✓
Square	990x990	✓	✓	✓	✓
Regtengular	590x690	✓	✓	✓	✓
Regtengular	690x790	✓	✓	✓	✓
Regtengular	690x1090	✓	✓	✓	✓
Regtengular	690x1190	✓	✓	✓	✓
Regtengular	690x1390	✓	✓	✓	✓
Regtengular	790x1390	✓	✓	✓	✓
Regtengular	790x1590	✓	✓	✓	✓

COLOUR TYPES:



SHAPE	SIZE	EDGE TYPES				
		flat edge 18	bevel edge 18	reverse bevel edge 18	reverse bevel edge	demi bullnose edge 25
Square	500 x 500	✓	—	—	—	✓
Square	600 x 600	—	✓	—	—	✓
Square	700 x 700	—	✓	—	—	✓
Square	800 x 800	✓	✓	—	—	✓
Square	900 x 900	✓	✓	—	—	✓
Round	Ø 600	—	✓	✓	✓	—
Round	Ø 700	—	✓	✓	✓	—
Round	Ø 800	—	✓	✓	✓	—
Round	Ø 900	—	✓	✓	✓	—
Round	Ø 1000	—	✓	✓	✓	—
Round	Ø 1100	—	✓	✓	✓	—
Rectangular	500 x 1000	✓	—	—	—	✓
Rectangular	700 x 1100	—	✓	—	—	✓
Rectangular	800 x 1200	✓	✓	—	—	✓
Rectangular	800 x 1400	✓	✓	—	—	✓
Rectangular	900 x 1800	—	—	—	—	✓

Table top colours on page 236 - 237

On request: the table tops can be produced in other sizes and colours than indicated above. Please check with our team.

COLOUR TYPES:

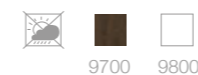

SHAPE	SIZE	EDGE TYPES				
		flat edge 18	flat edge 30			
Square	600 x 600	✓	✓			
Square	700 x 700	✓	✓			
Square	800 x 800	✓	✓			
Square	900 x 900	✓	✓			
Round	Ø 600	✓	✓			
Round	Ø 700	✓	✓			
Round	Ø 800	✓	✓			
Round	Ø 900	✓	✓			
Round	Ø 1000	✓	✓			
Round	Ø 1200	✓	✓			
Rectangular	700 x 1100	✓	✓			
Rectangular	800 x 1200	✓	✓			
Rectangular	800 x 1400	✓	✓			
Rectangular	900 x 1800	✓	✓			

Table top colours on page 236 - 237

On request: the table tops can be produced in other sizes and colours than indicated above. Please check with our team.

SOLID COMPACT TABLE TOP COLOURS  
AND ECO RANGE SOLID COMPACT TABLE TOPS

Except white, other colours are recommended only in shades areas

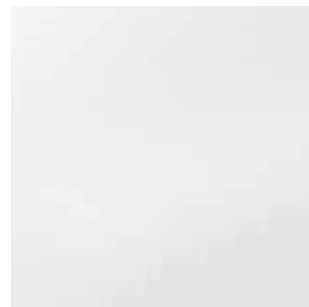

1050M White



1049M Black



3039M Wenge



3120M Rustica



3167M Chalky Oak



5101M Chement



1049WGR1 Woodgrain Nero



5054M Botanico Ivory



5056M Botanico Brown



3177M Linewood

LAMINATE CHIPBOARD TOP COLOURS (WITH ABS EDGE)



9700 Wenge

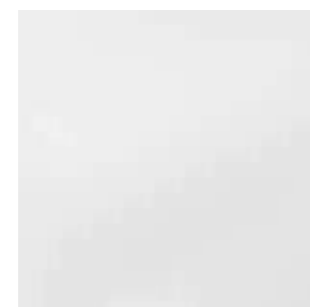

9800 White

POLIMER LAMINATED MDF CORE TABLE TOP COLOURS



74 Gold



76 Yellow



77 Black



79 Pear



81 Cream



83 White



84 Grey



86 Dark Walnut



87 Maple

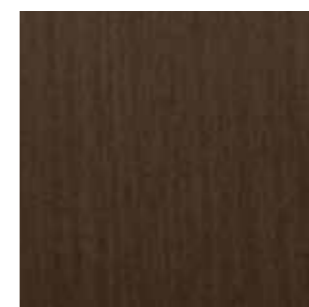

89 Wenge



90 Claret Red



91 Orange



93 Walnut



96 Cherry



99 Dark Cherry

## METAL BASE COLOURS

---



Satin Anodized Aluminium



Brushed Stainless

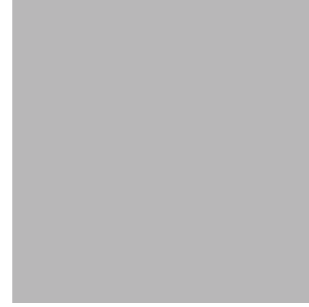

Silver Metalik / RAL 9006



Taupe / RAL 1019  
Powder Coated Mat



Black / RAL 9005  
Powder Coated Mat



Anthracite / RAL 7016  
Powder Coated Mat

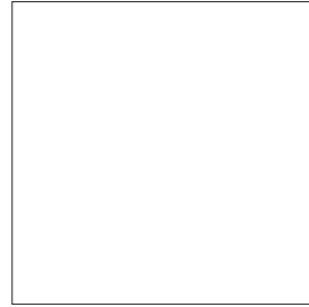

White / RAL 9016  
Powder Coated Mat

### NOTIFICATION

- PAPTAYA reserves the right to modify or upgrade products, materials and colours without prior notice.
- Technical details and images in this catalogue are indicative.  
The printed colours may differ slightly from the actual ones to technical reasons on printing.
- All dimensions indicated in technical features are in mm.



[www.papatya.com.tr](http://www.papatya.com.tr)



