

Royal Botania

Belgian outdoor luxury

“ TO THOSE WHO HAVE EXPERIENCED THE PASSION
FOR BEAUTY, THE ORDINARY WILL NO LONGER
APPEAL. ”

Willem Elsschot
1882-1960



008
OUTDOOR FURNITURE

258
UMBRELLAS

268
ACCESSORIES & PROJECTS

OUTDOOR FURNITURE COLLECTION

P 008 AMBIENT PICTURES

- P 130 ALURA
- P 134 ALURA LOUNGE
- P 148 BEACHER
- P 150 DEL REY
- P 152 DISCUS
- P 156 FOLIA
- P 158 IXIT
- P 164 JIVE
- P 166 KOKOON
- P 168 LAZY
- P 172 LUSIT LOUNGE
- P 178 NEW ENGLAND
- P 180 NINIX
- P 190 NINIX LOUNGE

- P 202 O-ZON
- P 208 QT
- P 210 TABOELA
- P 220 TEA TIME
- P 226 TRAVERSE
- P 228 TWIST
- P 230 U-NITE
- P 234 VIGOR
- P 236 VIGOR LOUNGE
- P 242 WAVE
- P 244 XQI
- P 248 ZENHIT
- P 254 ZIDIZ

UMBRELLAS

- P 258 UMBRELLAS
- P 266 UMBRELLA BASES

OUTDOOR ACCESSORIES

- P 268 MAINTENANCE
- P 270 FABRICS
- P 274 CUSHIONS
- P 274 OUTDOOR COVERS
- P 276 MATERIALS
- P 280 OUTDOOR LIGHTING

PROJECTS

- P 284 PROJECTS

YOUR LEISURE, OUR PLEASURE

For devotees of aesthetic refinement our dedicated team has created a line of exceptional outdoor furniture. The successful blend of precision and functionality is aimed at fulfilling each and every wish of our discerning customers. Indeed, your leisure is our pleasure.

Pour les adeptes de l'esthétisme, notre équipe a créé une ligne exceptionnelle de mobilier de jardin. Un savant mélange de précision et de fonctionnalité vise à satisfaire chacun des désirs de nos clients. En effet, votre loisir est notre plaisir.

Für begeisterte Anhänger der ästhetischen Verfeinerung hat unser engagiertes Team eine Linie außergewöhnlicher Gartenmöbel erschafft. Die erfolgreiche Mischung aus Präzision und Funktionalität ist auf die Erfüllung jedes einzelnen Wunsches unserer privilegierten Kunden ausgerichtet. In der Tat, Ihre Freizeit ist unser Vergnügen.

Voor liefhebbers van esthetische verfijning, heeft ons toegewijd team een collectie uitzonderlijke buitenmeubelen gecreëerd. De succesvolle samensmelting van precisie en functionaliteit is gericht op het ver vullen van iedere wens van ons geprivilegieerd cliënteel. Inderdaad, uw vrije tijd is onze passie.

Per gli appassionati della perfezione estetica abbiamo creato una linea di mobili da giardino eccezionali. L'insieme di precisione e funzionalità è finalizzato a soddisfare ogni singolo desiderio della nostra clientela privilegiata. Il Vostro tempo libero è la nostra passione.

Para los más exigentes en cuanto al diseño, nuestro equipo ha creado una línea excepcional de muebles de exterior. La lograda mezcla entre precisión y funcionalidad va dirigida a cumplir cada uno de los deseos más exigentes de nuestros privilegiados clientes. Efectivamente, su ocio es nuestra dedicación.



OUR DESIGNERS

The design of a product determines its DNA, and is therefore the most important step in its conception. With this in mind, we engage the talents of carefully selected external designers to complement the work of our in-house design team. The result is a wide range of characterful products, rich in variety and always stylish and refined.



Frank Boschman
Vigor, Tea Time, Lusit collections

Le design d'un produit définit son ADN. C'est donc l'étape cruciale de sa conception. Bien conscients de cela, nous faisons appel aux compétences de designers extérieurs soigneusement sélectionnés qui travaillent en complément de notre équipe interne de création. Il en résulte une importante collection de créations pleine de caractère, variée, toujours élégante et raffinée.

“GOOD DESIGN IS A LANGUAGE, NOT A STYLE”

Massimo Vignelli
1931-2014

Het ontwerp van een product bepaalt het DNA ervan, en is daarom de meest belangrijke stap in zijn totstandkoming. Met dit in gedachten, vragen we aan nauwkeurig gekozen externe ontwerpers, om samen met ons intern ontwerpersteam het ontwerp verder op punt te stellen. Dit resulteert in een uitgebreid gamma van karakteristieke producten, zeer gevarieerd en immer stijlvol en verfijnd.

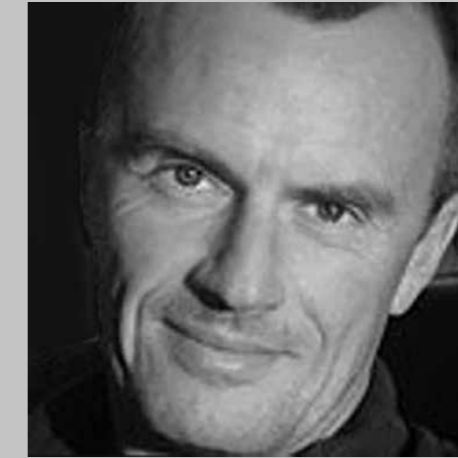

Pierre Stelmazyk
New England collection



Kris Van Puyvelde
Alura, Beacher, Del Rey, Discus, Folia, Ixit, Jive, Lazy, Lusit, Ninix, O-Zon, Qt, Taboela, Twist, U-Nite, Xqi, Zenhit, Zidiz, Palma collections

Il design di un prodotto determina il suo DNA ed è quindi il passo più importante nella sua concezione. Per questo motivo integriamo i talenti di designers esterni, attentamente selezionati, al lavoro del nostro team di progettazione interno. Il risultato è una vasta gamma di prodotti caratteristici, variegati e sempre eleganti e raffinati.

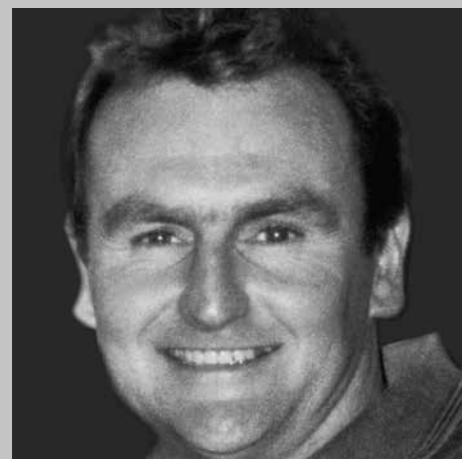

Olivier Le Pensec †
Kokoon collection

Das Design eines Produktes bestimmt seine DAN, und ist deshalb der wichtigste Schritt in dessen Entwicklungsprozess. Mit diesem Hintergedanken engagieren wir talentierte und sorgfältig ausgewählte externe Designer, um die Projekte unseres IN-House-Designteams zu ergänzen. Dadurch haben wir eine Reihe von aufregenden Produkten und eine sehr große Varietät von unterschiedlichen Stilen, die jedoch immer sehr geschmackvoll und raffiniert sind.



Mathias De Ferm
Traverse collection



Gustav Störm
Wave collection

El diseño de un producto determina su ADN, por lo tanto, es el paso más importante en su creación. Con esto en mente, contratamos los talentos de diseñadores externos cuidadosamente seleccionados para complementar el trabajo de nuestro equipo de diseño interno. El resultado se traduce en una amplia gama de productos característicos, ricos en variedad y siempre elegantes y refinados.



Erik Nyberg
Wave collection













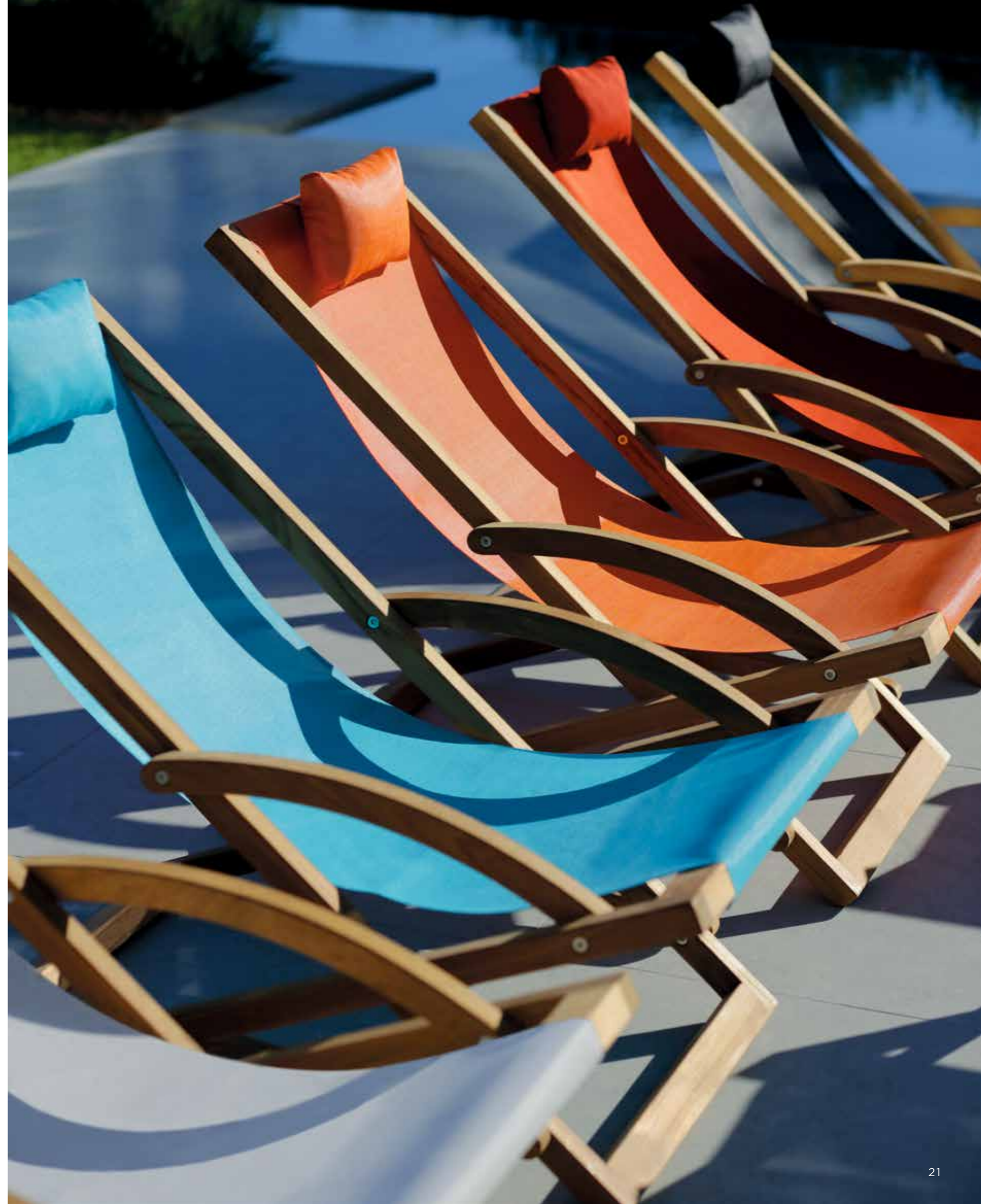









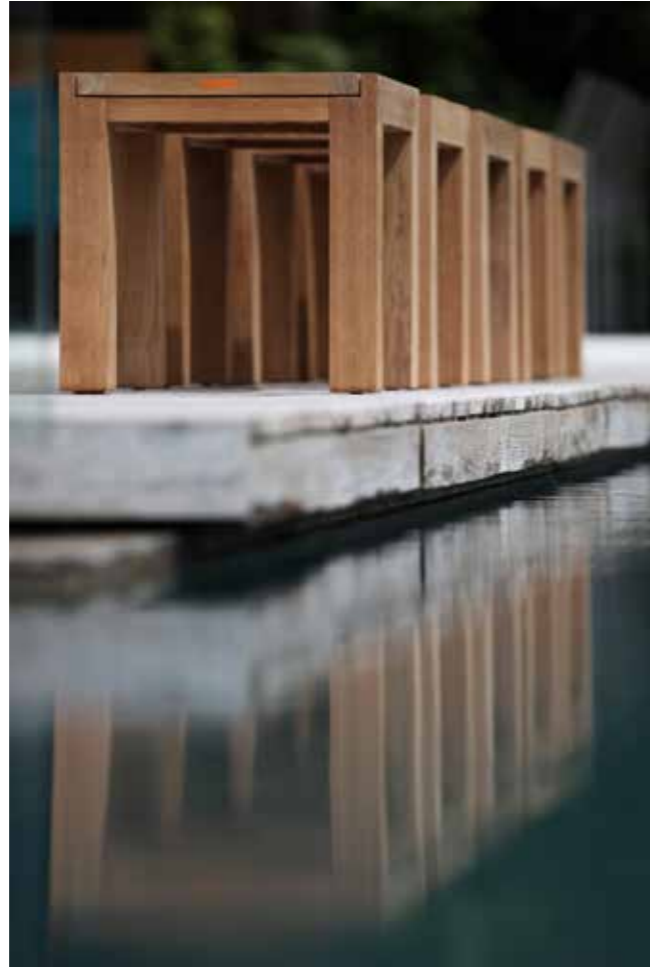

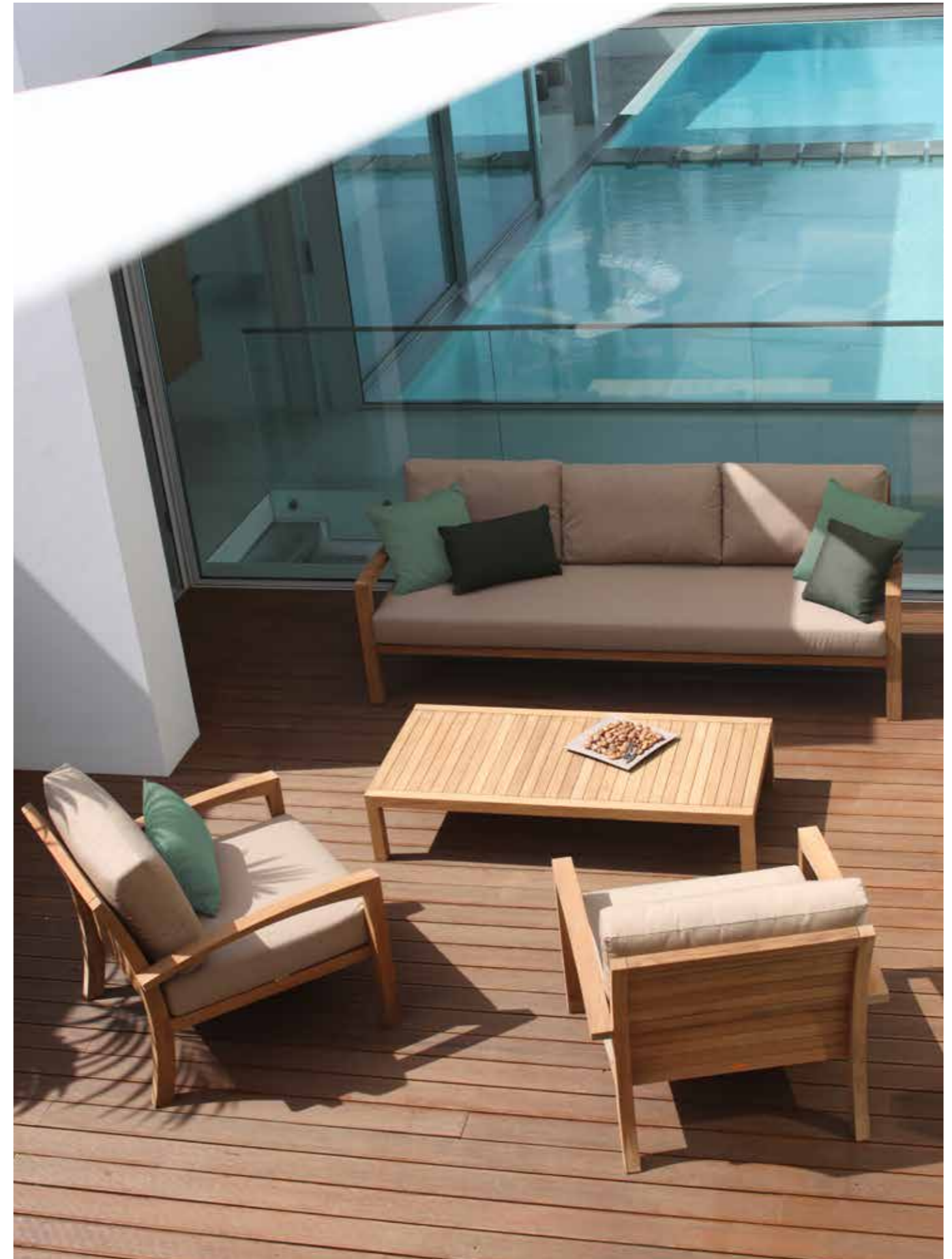











LAZY











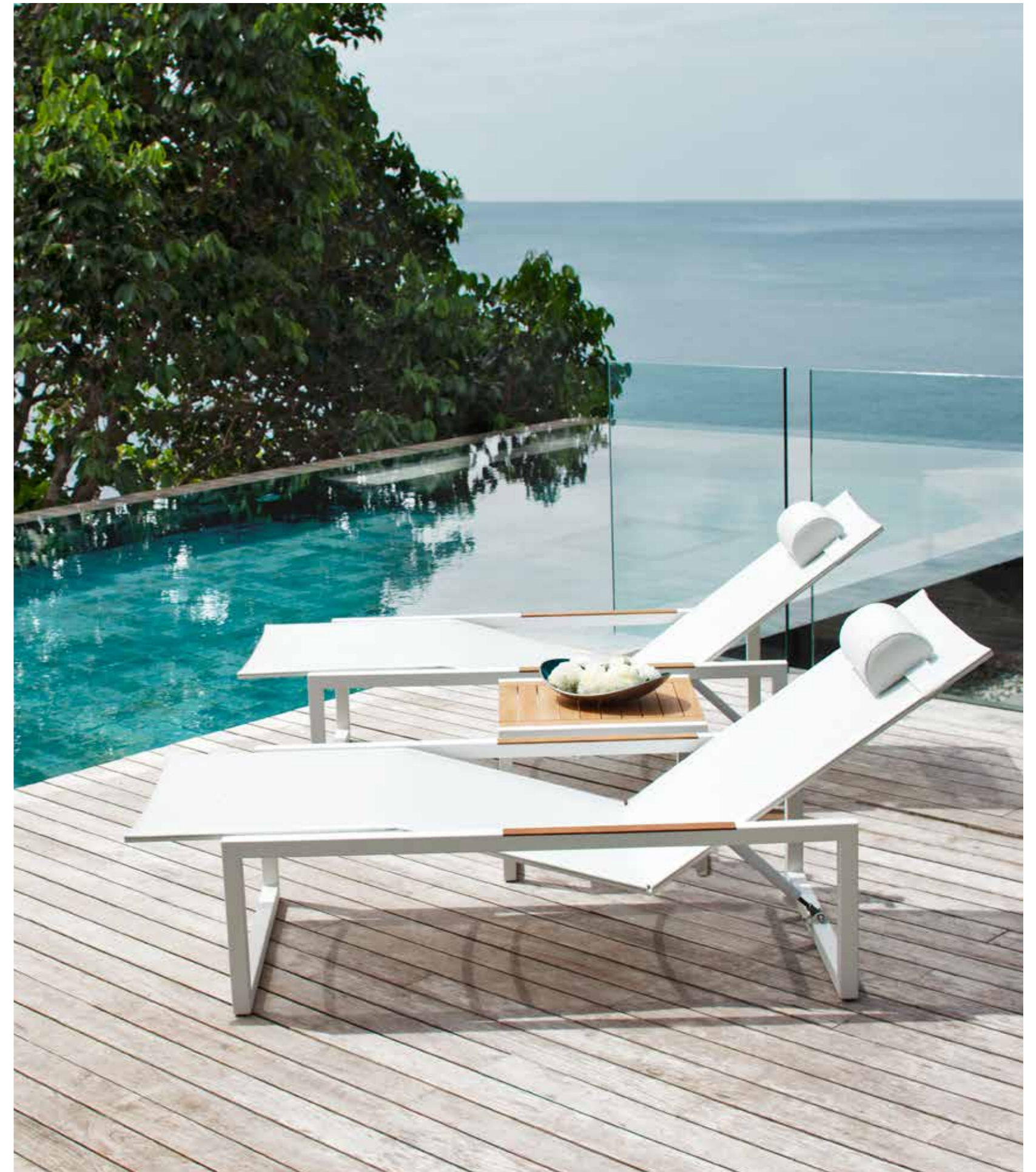









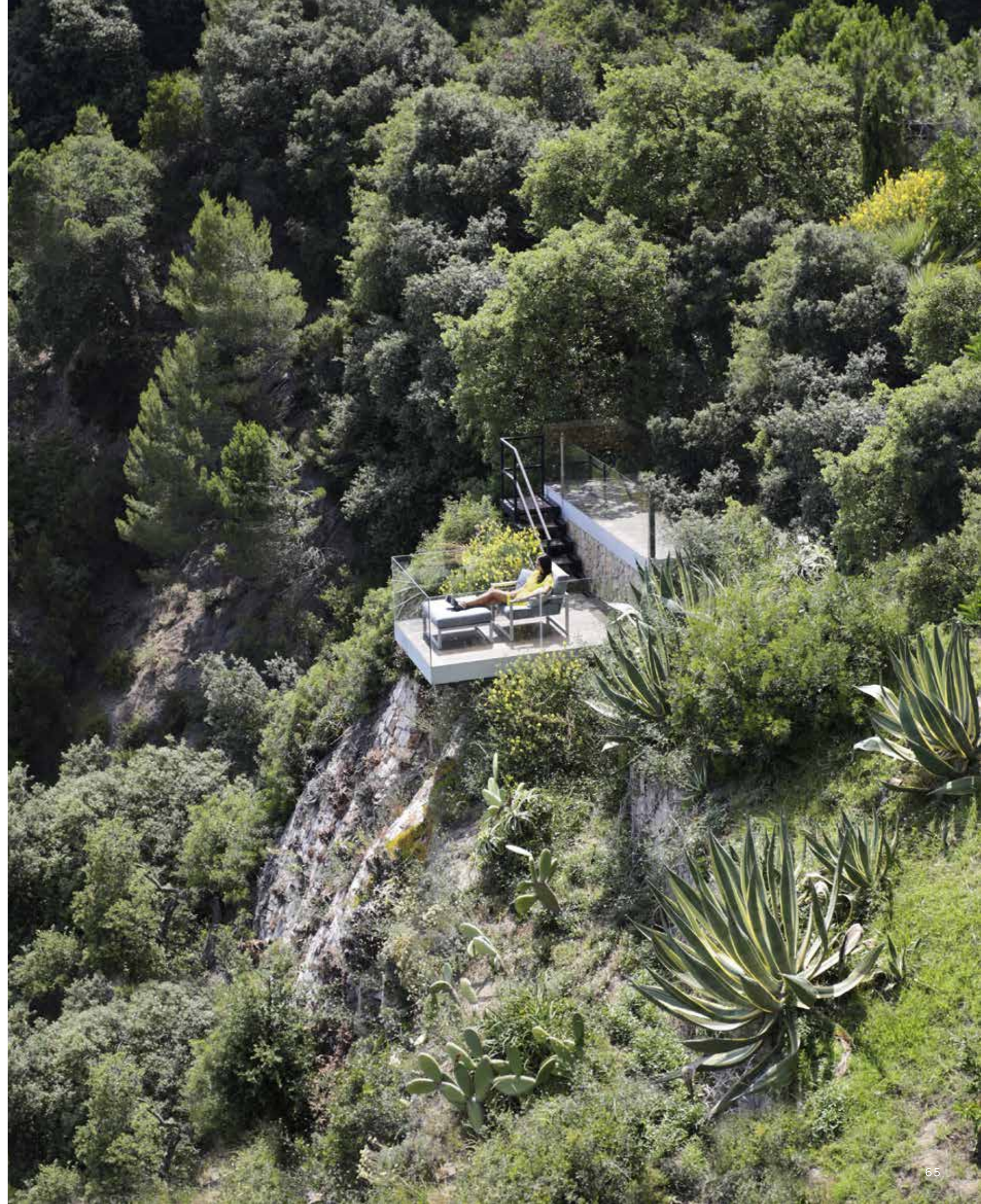





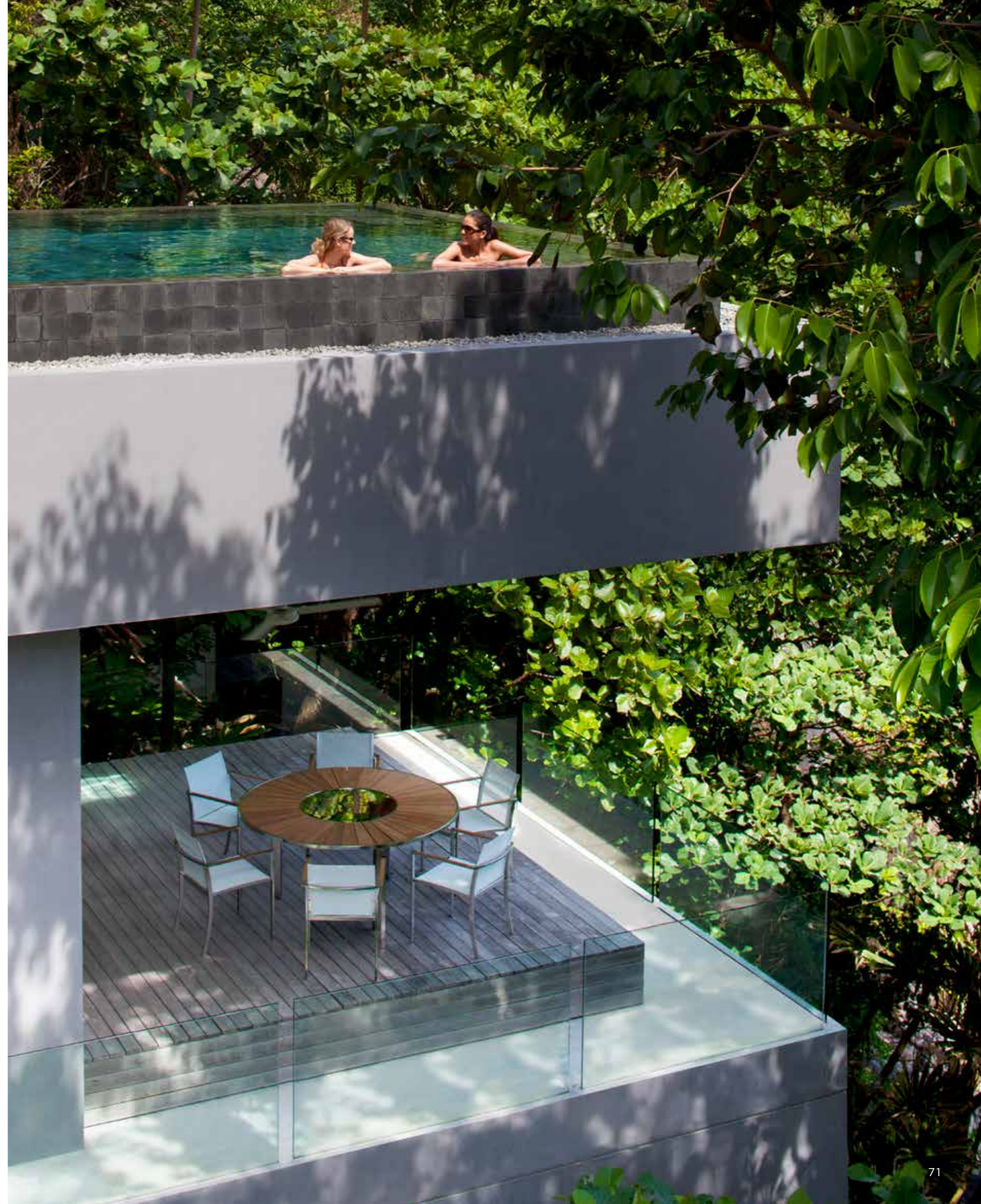

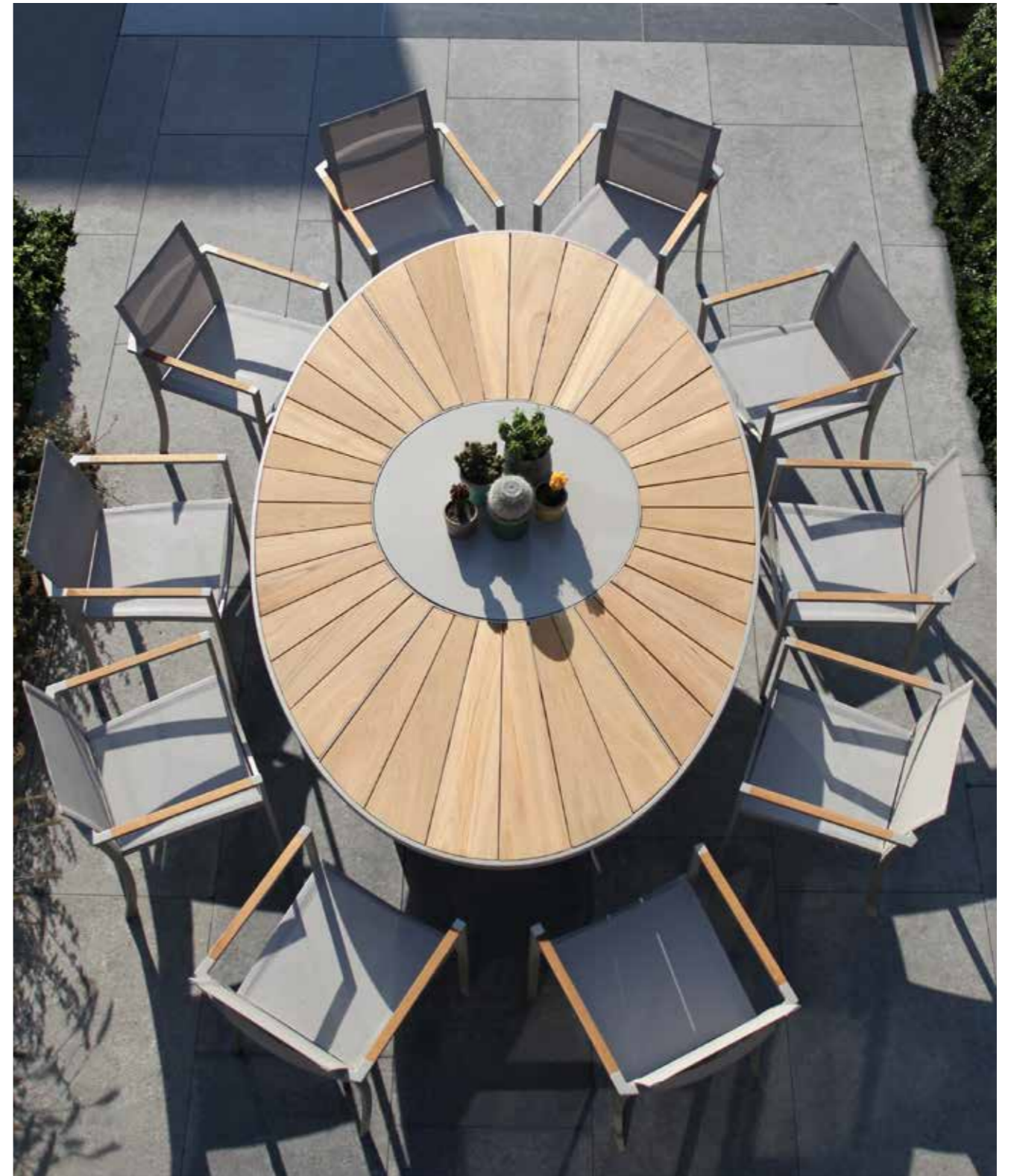
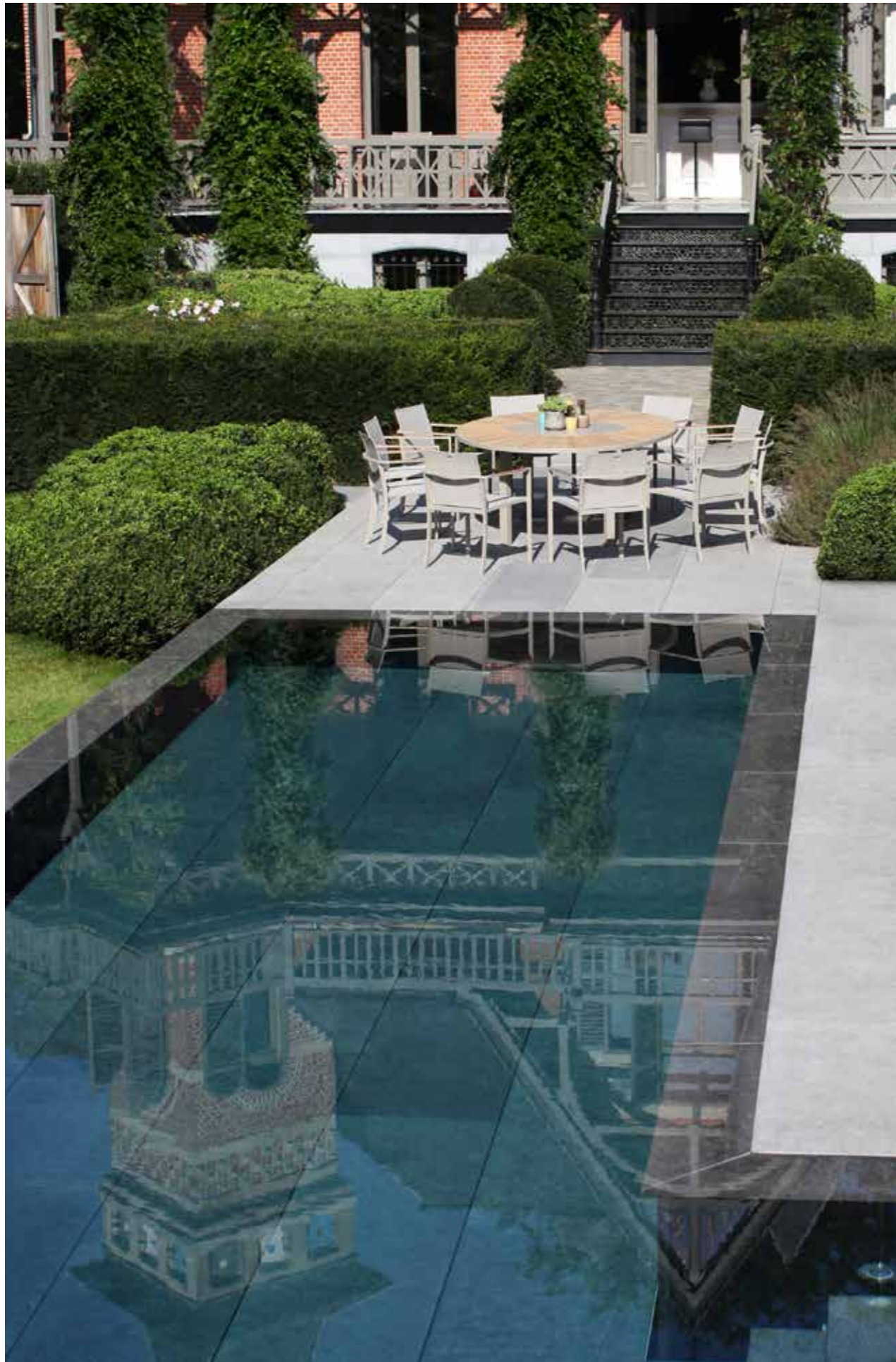















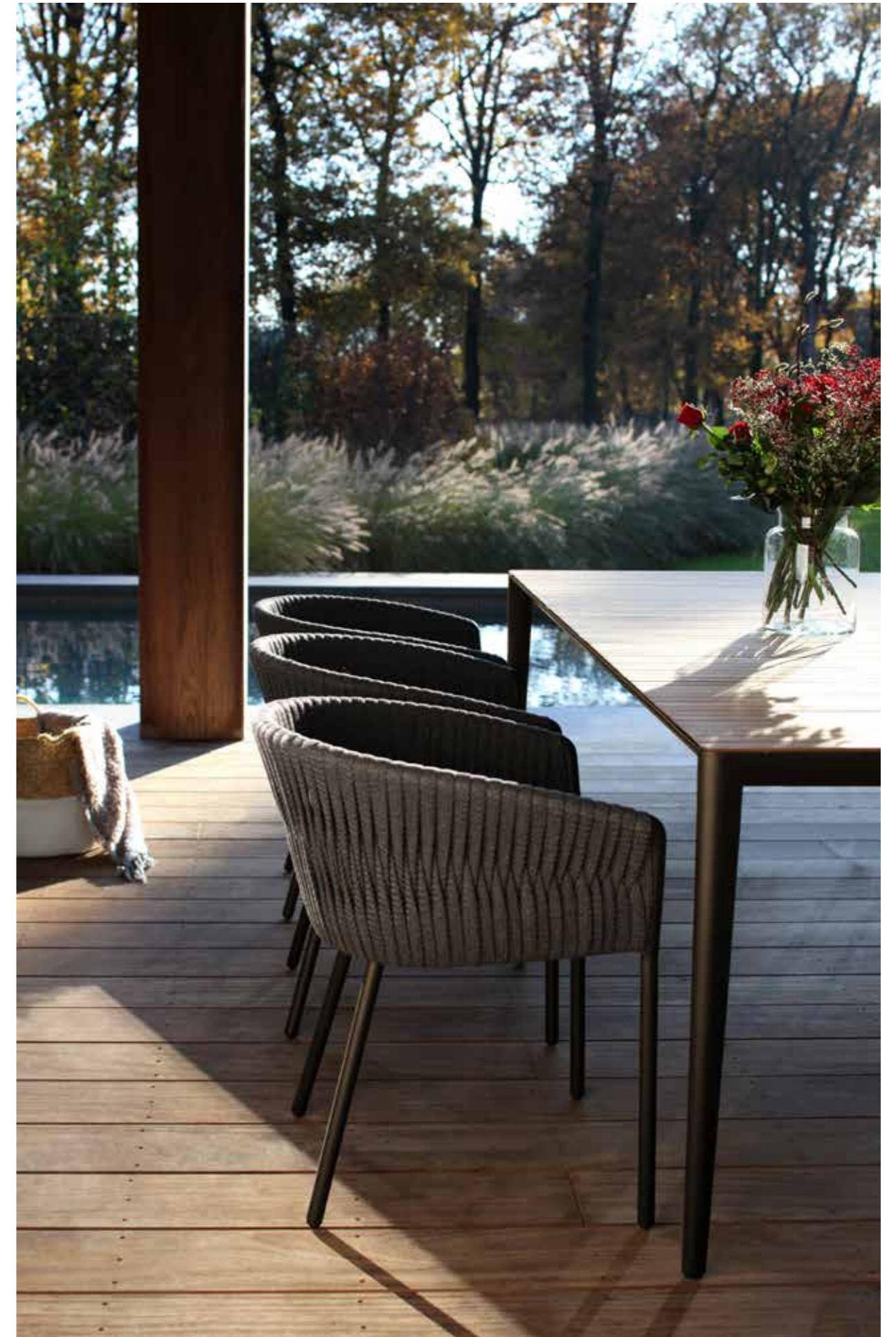





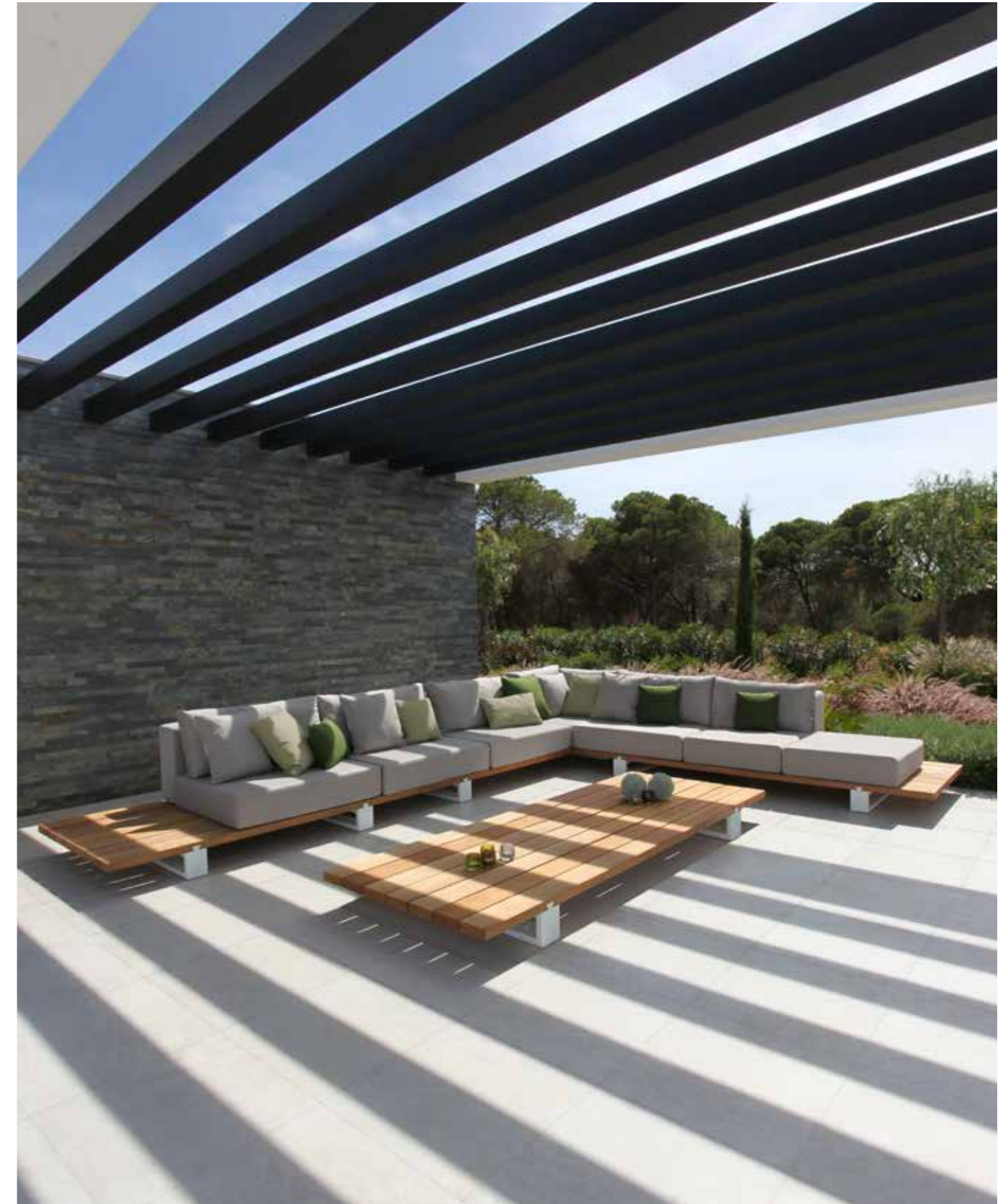

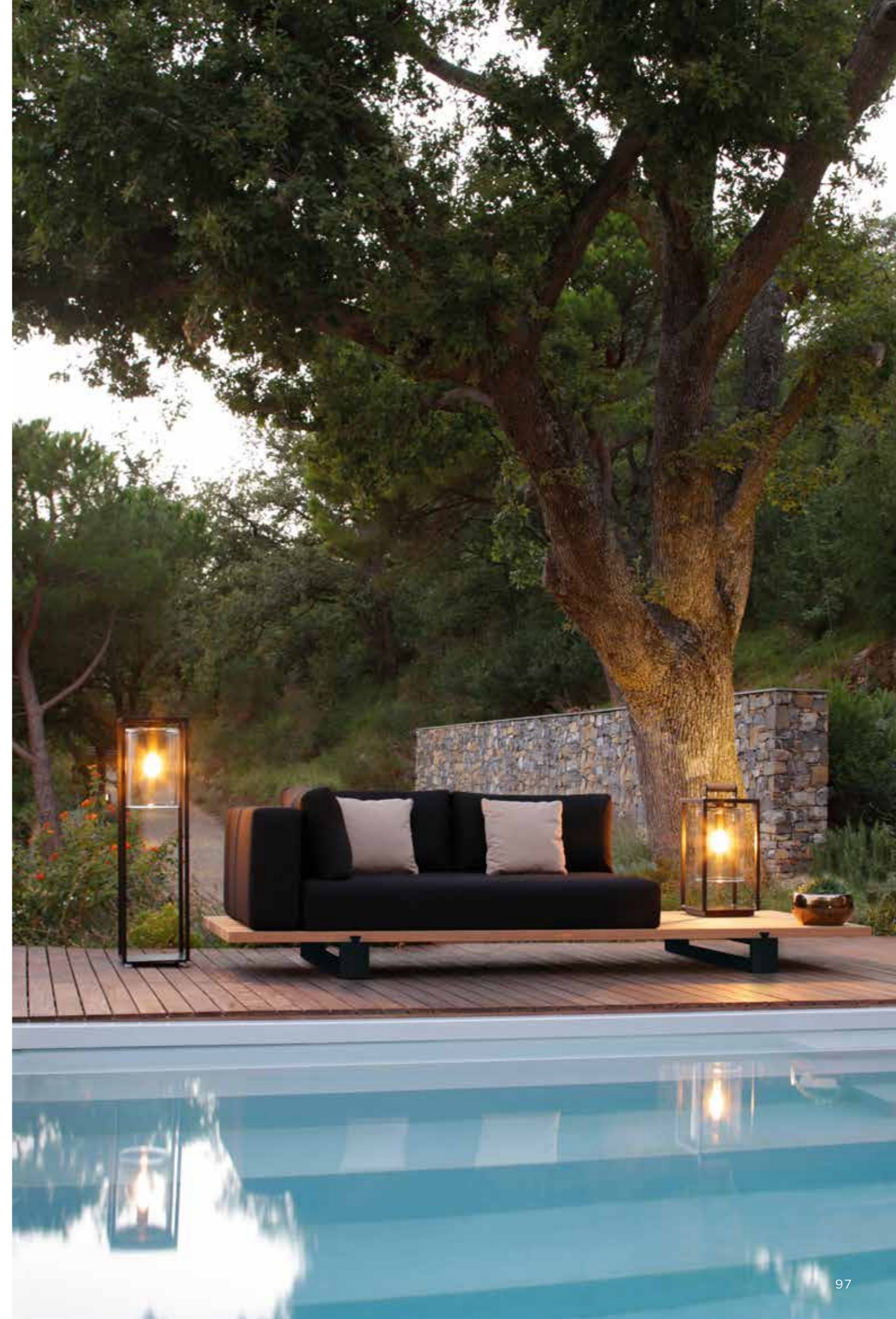









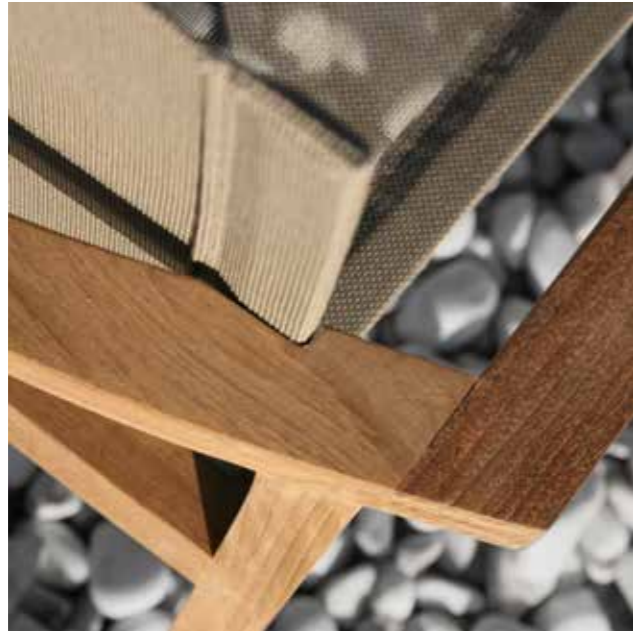















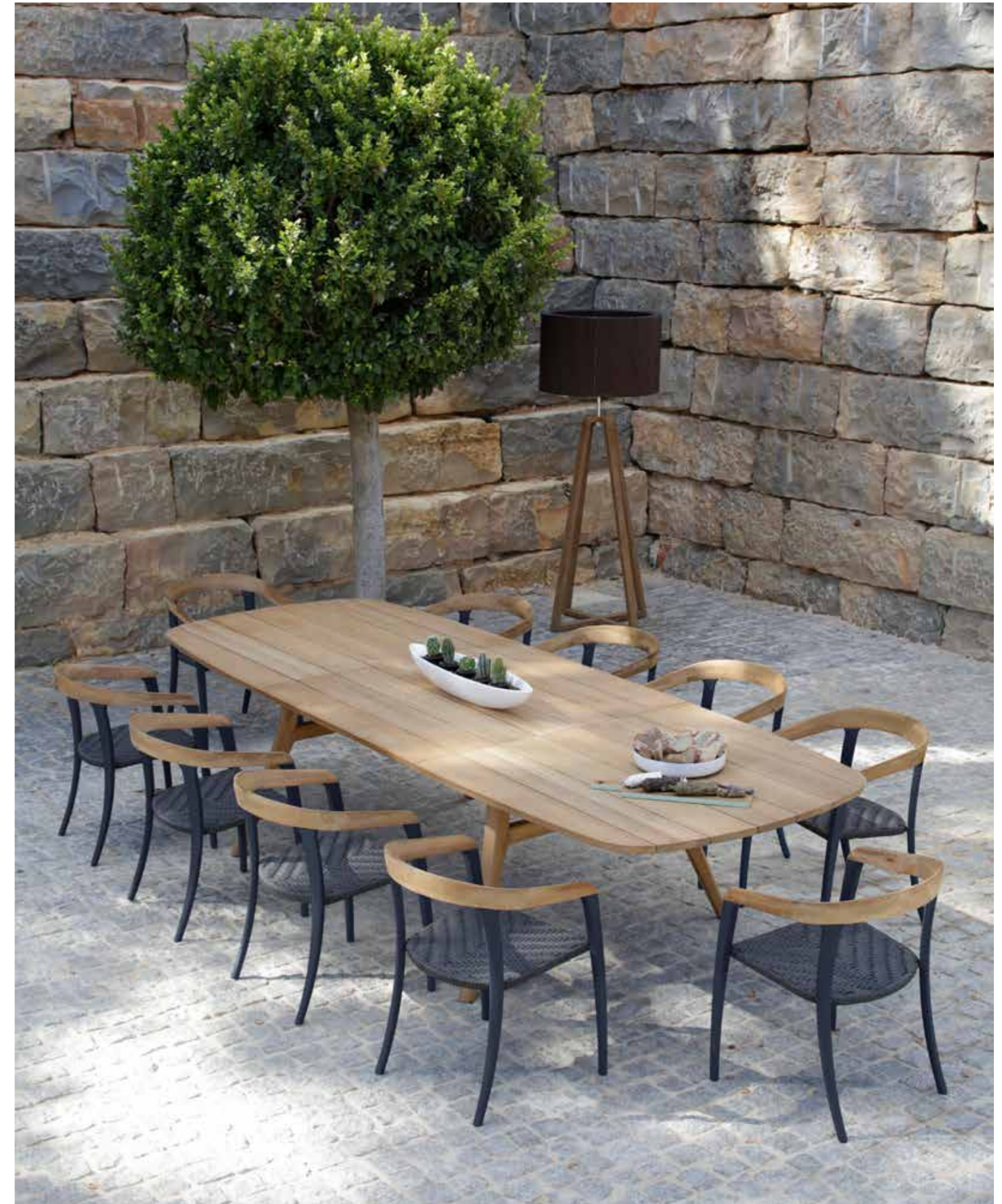





SPECIFICATIONS

You want to find out more ? Not just about size and specification but also about the beautiful materials these Royal Botania pieces are made of? You will probably find the answers to your questions here, if not, your Royal Botania dealer will be happy to help you.

Vous voulez en savoir plus? Pas seulement sur les dimensions et quelques spécificités mais aussi sur la qualité des matériaux des produits Royal Botania? Vous trouverez ces réponses à vos questions ici, sinon votre revendeur Royal Botania sera ravi de vous aider.

Möchten Sie mehr über die Maße, Ausführungen und Qualität, der von Royal Botania verwendeten Materialien erfahren? Die ersten Antworten finden Sie auf den folgenden Seiten. Für weitere Fragen steht Ihnen Ihr Royal Botania Händler jederzeit zur Verfügung.

U wil meer te weten te komen niet alleen betreffende de afmetingen en specificaties, maar tevens betreffende de prachtige materialen waaruit deze Royal Botania meubelen vervaardigd zijn? Waarschijnlijk vindt U hier de antwoorden op uw vragen, en zoniet zal uw Royal Botania dealer U graag voorthelpen.

Volete saperne di più circa i bellissimi materiali che Royal Botania usa per creare questi prodotti? Probabilmente qui troverete le risposte alle Vostre domande, altrimenti il Vostro rivenditore Royal Botania sarà lieto di aiutarVi.

Quiere saber más no solamente sobre las medidas y las especificaciones, pero también sobre las espléndidas materiales de los muebles Royal Botania? Es muy probable que encuentre aquí respuestas a sus preguntas, y sino, su distribuidor le ayudará con mucho gusto.



IMPORTANT INFORMATION

AVAILABILITY

STANDARD

Of these products we keep an inventory based on expected sales quantities.

ON REQUEST

Limited or no inventory. Delivery time of these products is on demand. Consult us for lead time.

CUSHIONS

Cushions are always on request. Average lead time is three weeks, but can vary in high season. For some modular lounge collections we have a 'standard' offer of cushions of which we will keep inventory.

We offer three price categories for the cushions:

- Standard cushion price for lounge collections.
5 or 6 standard category B fabrics with special price.
- Price for category A fabrics.
Colors can be found on page 270.
- Price for category B fabrics.
Colors can be found on pages 270 - 273.

PRICES

All prices shown are per piece, unless indicated otherwise.

REF: NO PRICE

ALURA

design by Kris Van Puyvelde



BAR CHAIR - ALR43...

0,5 m³ (4) 9,8 kg

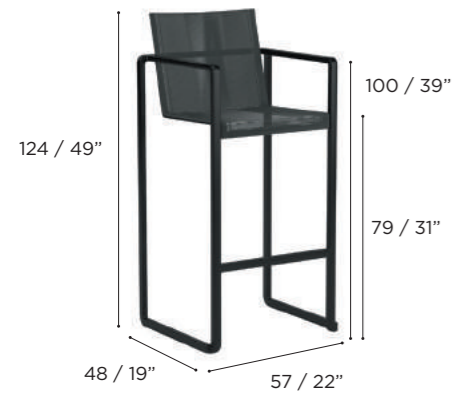

	COATED ALUMINIUM	COATED ALUMINIUM	COATED ALUMINIUM
	WR	S	A
WU	ALR 43 TWWU		
BATYLINE PG	ALR 43 TSPG		
BATYLINE ZS	ALR 43 TAZU		
OPTIONAL TEAK ARMRESTS	ALR 43 T ARWSET		
	CUSHION		
	PIL ALR 43 T ...		
CAT. A			
CAT. B			

FOOTREST - ALR...

0,15 m³ (4) 3,1 kg

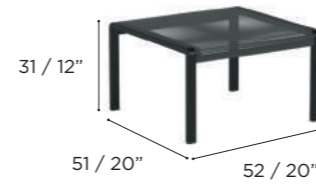

	COATED ALUMINIUM	COATED ALUMINIUM	COATED ALUMINIUM
	WR	S	A
WU	ALR F TWWU		
BATYLINE PG	ALR F TSPG		
BATYLINE ZS	ALR F TAZU		

CHAIR - ALR47...

0,34 m³ (4) 6,4 kg

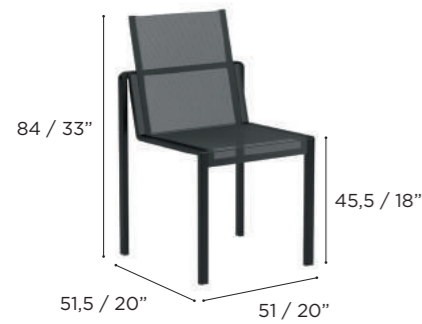

	COATED ALUMINIUM	COATED ALUMINIUM	COATED ALUMINIUM
	WR	S	A
WU	ALR 47 TWWU		
BATYLINE PG	ALR 47 TSPG		
BATYLINE ZS	ALR 47 TAZU		
	CUSHION		
	PIL ALR 47 T ...		
CAT. A			
CAT. B			

RELAX CHAIR - ALR77...

0,44 m³ (4) 9,5 kg

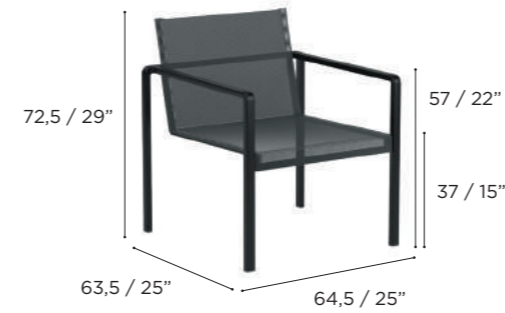

	COATED ALUMINIUM	COATED ALUMINIUM	COATED ALUMINIUM
	WR	S	A
WU	ALR 77 TWWU		
BATYLINE PG	ALR 77 TSPG		
BATYLINE ZS	ALR 77 TAZU		
OPTIONAL TEAK ARMRESTS	ALR 77 T ARWSET		
	CUSHION		
	PIL ALR 77 T ...		
CAT. A			
CAT. B			

PP 9, 18 - 19

ARMCHAIR - ALR55...

0,38 m³ (4) 9,9 kg

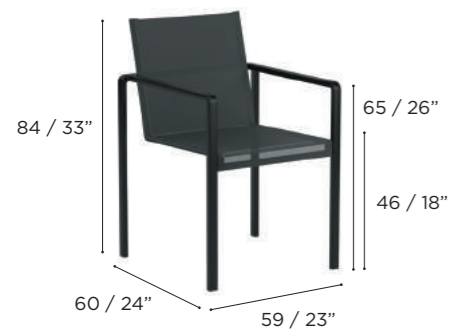

	COATED ALUMINIUM	COATED ALUMINIUM	COATED ALUMINIUM
	WR	S	A
WU	ALR 55 TWWU		
BATYLINE PG	ALR 55 TSPG		
BATYLINE ZS	ALR 55 TAZU		• 429
OPTIONAL TEAK ARMRESTS	ALR 55 T ARWSET		
	CUSHION		
	PIL ALR 55 T ...		
CAT. A			
CAT. B			

PP 13, 14 - 15, 16, 17, 84 - 85

LOUNGER - ALR195...

0,96 m³ (2) 22,7 kg INCL. HEADCUSHION



	COATED ALUMINIUM	COATED ALUMINIUM	COATED ALUMINIUM
	WR	S	A
WU	ALR 195 TWWU		
BATYLINE PG	ALR 195 TSPG		
BATYLINE ZS	ALR 195 TAZU		
OPTIONAL TEAK ARMRESTS	ALR 195 T ARWSET		
	CUSHION		
	PIL ALR 195 T ...		
CAT. A			
CAT. B			

PP 10 - 11



ALURA LOUNGE

design by Kris Van Puyvelde

STANDARD OFFER FOR ALURA LOUNGE COLLECTION (CATEGORY B FABRICS)

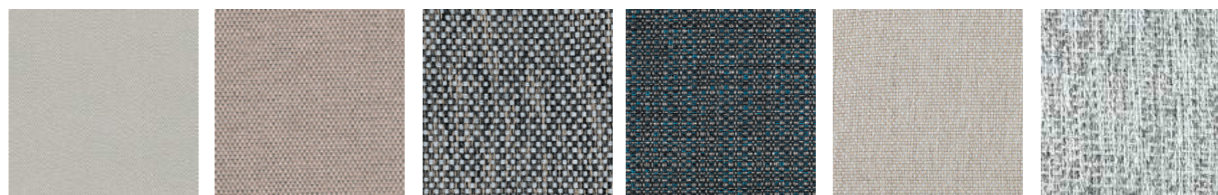

FROST LINEN
LAMINATED
ref: FLL

DESERT STONE
FLAX LAMINATED
ref: DSFL

CHARCOAL
DOT
ref: NCD

AQUA GREY
TWIN
ref: NAGT

WHITE
DOT
ref: NWD

NATURAL
SILVER DOT
ref: NSD

ALL OTHER FABRICS AVAILABLE ON REQUEST - PP 270 - 273



ALRL 80 / 160 LOUNGE TABLE

ALRL80: 0,15 m³ - ALRL160: 0,28 m³
 ALRL80: G: 26,8 kg / C: 25,8 kg / T: 19,1 kg
 ALRL160: G: 48,0 kg / C: 46,0 kg

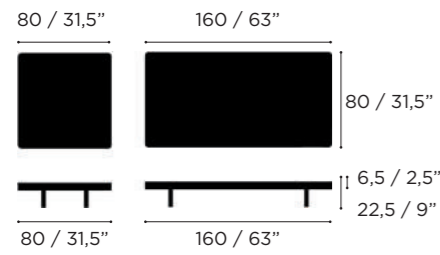

		COATED ALUMINIUM + BATYLINE		COATED ALUMINIUM + BATYLINE		COATED ALUMINIUM + BATYLINE	
		WR		S		A	
GLASS	WU	ALRL 80 GWRWU	ALRL 160 GWRWU				
	PG			ALRL 80 GSPG	ALRL 160 GSPG		
	ZU					ALRL 80 GAZU	ALRL 160 GAZU
CERAMIC	WUM	ALRL 80 CWRWUM	ALRL 160 CWRWUM				
	PG			ALRL 80 CSPG	ALRL 160 CSPG		
	ZUM					ALRL 80 CAZUM	ALRL 160 CAZUM
TEAK	TK	ALRL 80 WWR	ALRL 80 WS			ALRL 80 WA	

PP 18 - 19

ALRL 80 / 160 LTL LOUNGE TABLE

ALRL80: 0,15 m³ - ALRL160: 0,28 m³
 ALRL80: G: 25 kg / C: 24 kg / T: 17 kg
 ALRL160: G: 46 kg / C: 44 kg

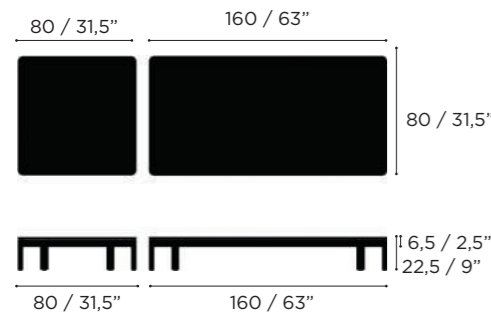

GLASS	WU	ALRL 80 LTL GWRWU	ALRL 160 LTL GWRWU				
	PG			ALRL 80 LTL GSPG	ALRL 160 LTL GSPG		
	ZU					ALRL 80 LTL GAZU	ALRL 160 LTL GAZU
CERAMIC	WUM	ALRL 80 LTL CWRWUM	ALRL 160 LTL CWRWUM				
	PG			ALRL 80 LTL CSPG	ALRL 160 LTL CSPG		
	ZUM					ALRL 80 LTL CAZUM	ALRL 160 LTL CAZUM
TEAK	TK	ALRL 80 LTL WWR	ALRL 80 LTL WS			ALRL 80 LTL WA	

ALRL 80 / 160 LTH LOUNGE TABLE

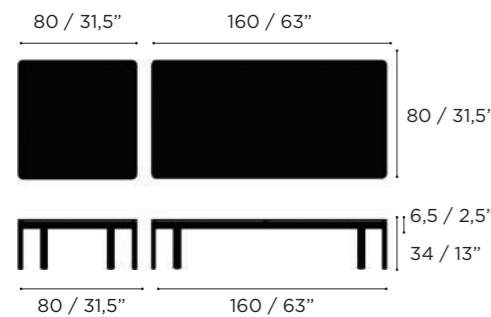

GLASS	WU	ALRL 80 LTH GWRWU	ALRL 160 LTH GWRWU				
	PG			ALRL 80 LTH GSPG	ALRL 160 LTH GSPG		
	ZU					ALRL 80 LTH GAZU	ALRL 160 LTH GAZU
CERAMIC	WUM	ALRL 80 LTH CWRWUM	ALRL 160 LTH CWRWUM				
	PG			ALRL 80 LTH CSPG	ALRL 160 LTH CSPG		
	ZUM					ALRL 80 LTH CAZUM	ALRL 160 LTH CAZUM
TEAK	TK	ALRL 80 LTH WWR	ALRL 80 LTH WS			ALRL 80 LTH WA	

PP 18 - 19

ALRL 80 / 160 TABLE TOP

ALRL80: G: 15,7 kg / C: 14,7 kg / T: 4,7 kg
 ALRL160: G: 31,4 kg / C: 29,4 kg

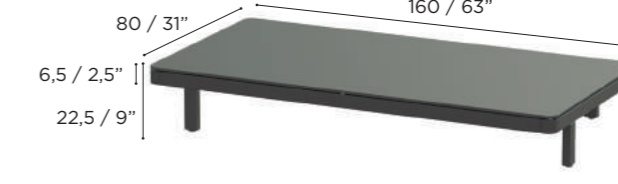
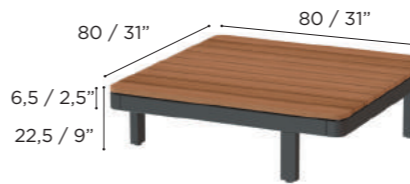
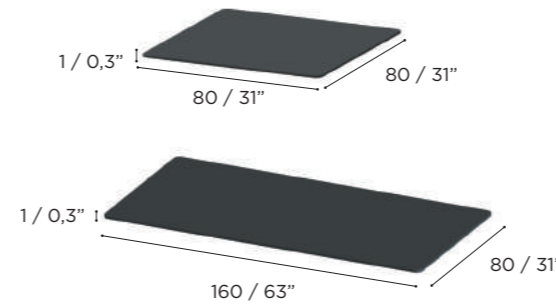

PIL ALRL CUSHIONS

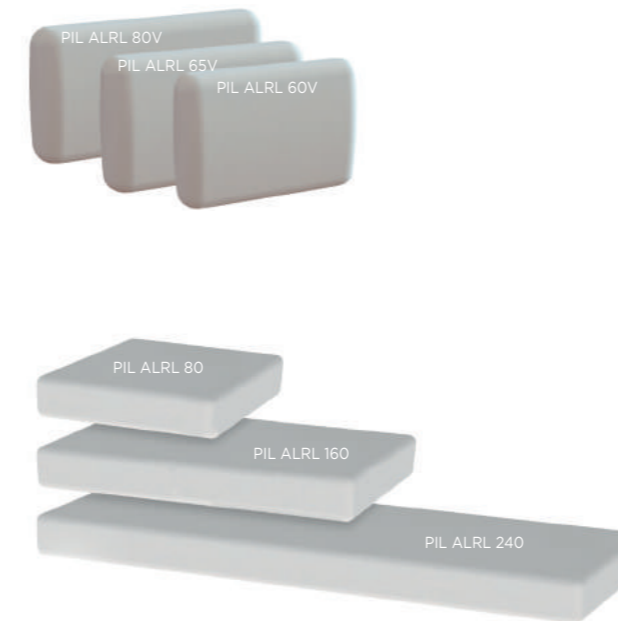

		ALURA LOUNGE TABLE TOP 80	ALURA LOUNGE TABLE TOP 160
GLASS	WU	ALRL 80 TOP GWU	ALRL 160 TOP GWU
	PG	ALRL 80 TOP GPG	ALRL 160 TOP GPG
	ZU	ALRL 80 TOP GZU	ALRL 160 TOP GZU
CERAMIC	WUM	ALRL 80 TOP CWUM	ALRL 160 TOP CWUM
	PG	ALRL 80 TOP CPG	ALRL 160 TOP CPG
	ZUM	ALRL 80 TOP CZUM	ALRL 160 TOP CZUM
TEAK	TK	ALRL 80 TOP W	

ALL ALURA LOUNGE 80 TABLE TOP COMBINATIONS ARE ALSO POSSIBLE FOR ALURA LOUNGE 160 TABLES (+2x ALRL80 TOP...)

	CUSHIONS FOR ALURA LOUNGE	
	PIL ALRL 60 V ... ARM 60 x 40	
STANDARD	•	
CAT. A	•	
CAT. B	•	
	PIL ALRL 65 V ... BACK / ARM 65 x 40	
STANDARD	•	
CAT. A	•	
CAT. B	•	
	PIL ALRL 80 V ... BACK / ARM 80 x 40	
STANDARD	•	
CAT. A	•	
CAT. B	•	

	CUSHIONS FOR ALURA LOUNGE	
	PIL ALRL 80 ... SEAT 80 x 80	
STANDARD	•	
CAT. A	•	
CAT. B	•	
	PIL ALRL 160 ... SEAT 160 x 80	
STANDARD	•	
CAT. A	•	
CAT. B	•	
	PIL ALRL 240 ... SEAT 240 x 80	
STANDARD	•	
CAT. A	•	
CAT. B	•	

ONE SEATER - ALRL100...

0,6 m³ 22 kg

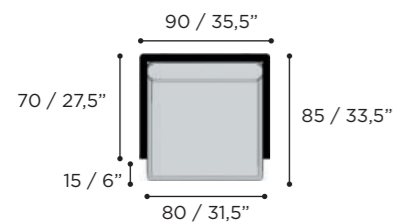

FOOT REST - ALRL80F...

0,25 m³ 14,5 kg

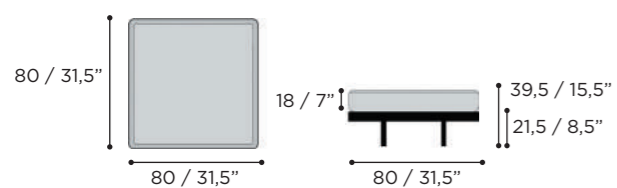

TWO SEATER - ALRL160...

1,1 m³ 35 kg

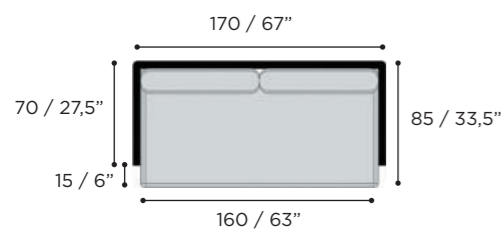

PP 8 - 9

	COATED ALUMINIUM	COATED ALUMINIUM	COATED ALUMINIUM
	WR	S	A
WU	ALRL 100 TWRWU		
PG	ALRL 100 TSPG		
ZU			ALRL 100 TAZU
	CUSHIONS		
	PIL ALRL 100 SET ED... (2 pcs)		
STANDARD			
CAT. A			
CAT. B			

WU	ALRL 80 F TWRWU		
PG	ALRL 80 F TSPG		
ZU			ALRL 80 F TAZU
	CUSHIONS		
	PIL ALRL 80 ED... (1 pc)		
STANDARD			
CAT. A			
CAT. B			

WU	ALRL 160 TWRWU		
PG	ALRL 160 TSPG		
ZU			ALRL 160 TAZU
	CUSHIONS		
	PIL ALRL 160 SET ED... (3 pcs)		
STANDARD			
CAT. A			
CAT. B			

THREE SEATER - ALRL240...

1,7 m³ 50 kg

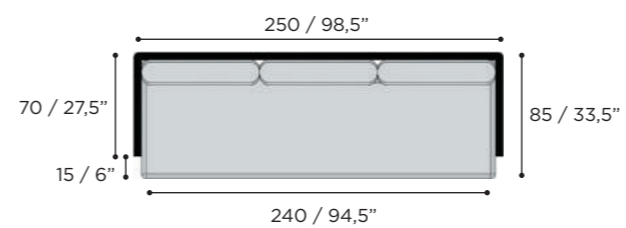

LEFT & RIGHT ARM MODULE - ALRL160...

1,1 m³ 34 kg

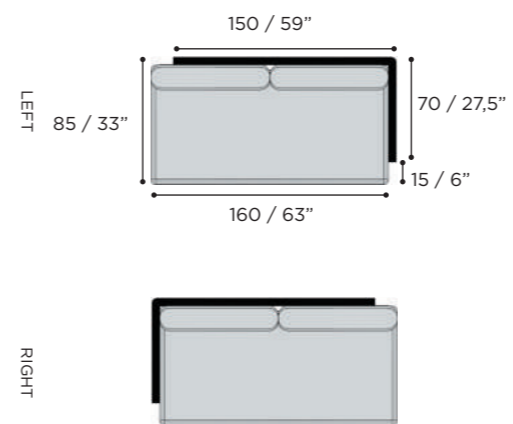

	COATED ALUMINIUM	COATED ALUMINIUM	COATED ALUMINIUM
	WR	S	A
WU	ALRL 240 TWRWU		
PG	ALRL 240 TSPG		
ZU			ALRL 240 TAZU
	CUSHIONS		
	PIL ALRL 240 SET ED... (4 pcs)		
STANDARD			
CAT. A			
CAT. B			

WU	ALRL 160 L TWRWU		
WU	ALRL 160 R TWRWU		
PG	ALRL 160 L TSPG		
PG	ALRL 160 R TSPG		
ZU			ALRL 160 L TAZU
ZU			ALRL 160 R TAZU
	CUSHIONS		
	PIL ALRL 160 SET ED... (3 pcs)		
STANDARD			
CAT. A			
CAT. B			

LEFT & RIGHT ARM MODULE - ALRL240...

1,7 m³ 49 kg

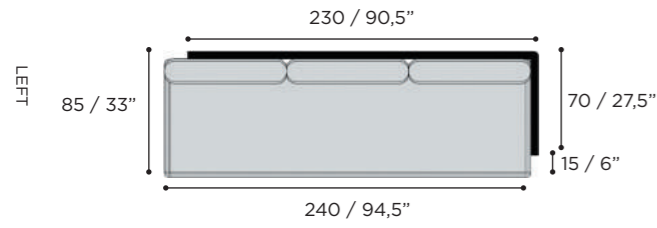

RIGHT

	COATED ALUMINIUM WR	COATED ALUMINIUM S	COATED ALUMINIUM A
WU	ALRL 240 L TWRWU		
WU	ALRL 240 R TWRWU		
PG	ALRL 240 L TSPG		
PG	ALRL 240 R TSPG		
ZU		ALRL 240 L TAZU	
ZU		ALRL 240 R TAZU	
CUSHIONS			
	PIL ALRL 240 SET ED... (4 pcs)		
STANDARD			
CAT. A			
CAT. B			

ALURA LOUNGE SET 01

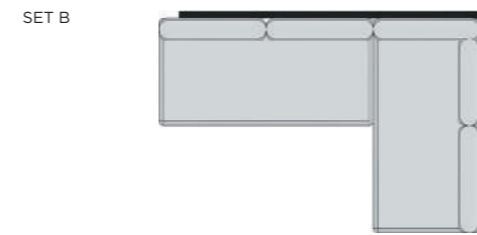
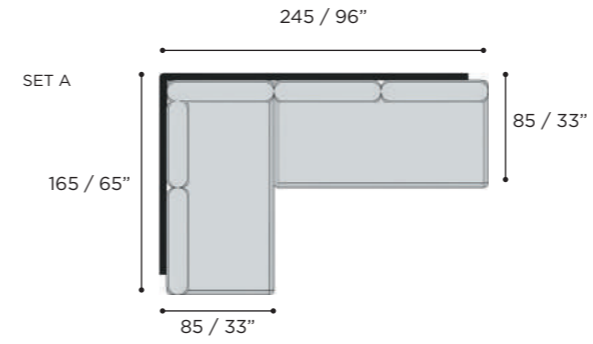

SET B

	COATED ALUMINIUM WR	COATED ALUMINIUM S	COATED ALUMINIUM A
WU	ALRL 01 A WRWU		
WU	ALRL 01 B WRWU		
PG	ALRL 01 A SPG		
PG	ALRL 01 B SPG		
ZU		ALRL 01 A AZU	
ZU		ALRL 01 B AZU	
CUSHIONS			
	PIL ALRL 01 AB SET ED... (7 pcs)		
STANDARD			
CAT. A			
CAT. B			

ALURA LOUNGE SET 02

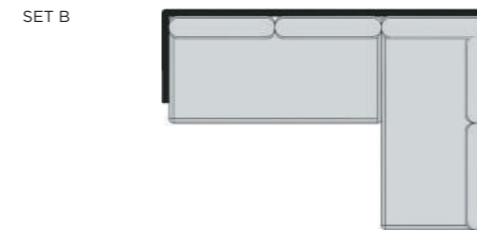
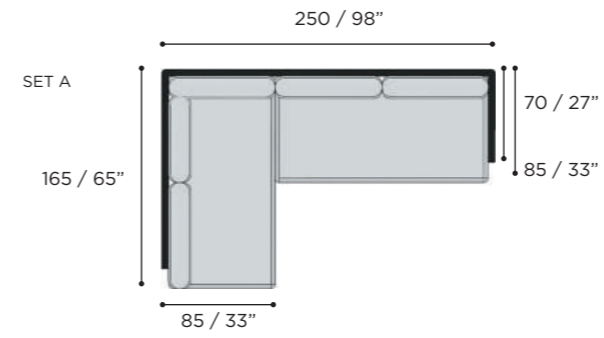

SET B

	COATED ALUMINIUM WR	COATED ALUMINIUM S	COATED ALUMINIUM A
WU	ALRL 02 A WRWU		
WU	ALRL 02 B WRWU		
PG	ALRL 02 A SPG		
PG	ALRL 02 B SPG		
ZU		ALRL 02 A AZU	
ZU		ALRL 02 B AZU	
CUSHIONS			
	PIL ALRL 02 AB SET ED... (7 pcs)		
STANDARD			
CAT. A			
CAT. B			



ALURA LOUNGE SET 03

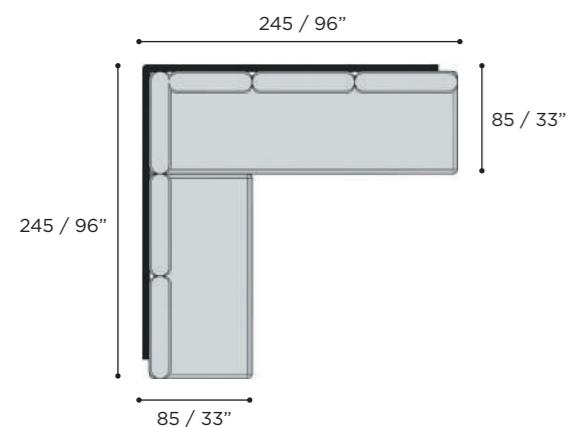

	COATED ALUMINIUM WR	COATED ALUMINIUM S	COATED ALUMINIUM A
BATYLINE	WU ALRL 03 WRWU		
	PG ALRL 03 SPG		
	ZU		ALRL 03 AZU
	CUSHIONS		
	PIL ALRL 03 SET ED... (8 pcs)		
STANDARD			
CAT. A			
CAT. B			

ALURA LOUNGE SET 05

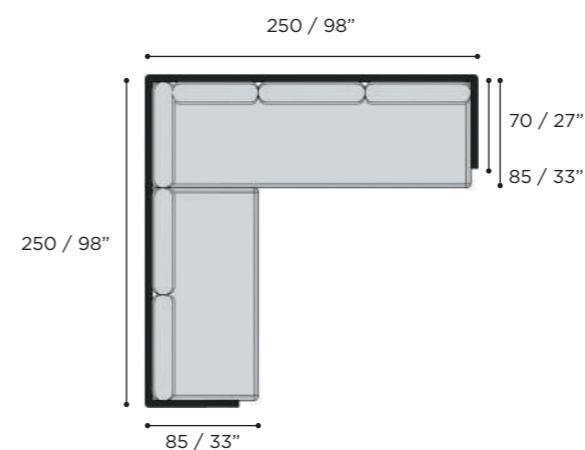

	COATED ALUMINIUM WR	COATED ALUMINIUM S	COATED ALUMINIUM A
BATYLINE	WU ALRL 05 WRWU		
	PG ALRL 05 SPG		
	ZU		ALRL 05 AZU
	CUSHIONS		
	PIL ALRL 05 SET ED... (8 pcs)		
STANDARD			
CAT. A			
CAT. B			

ALURA LOUNGE SET 04

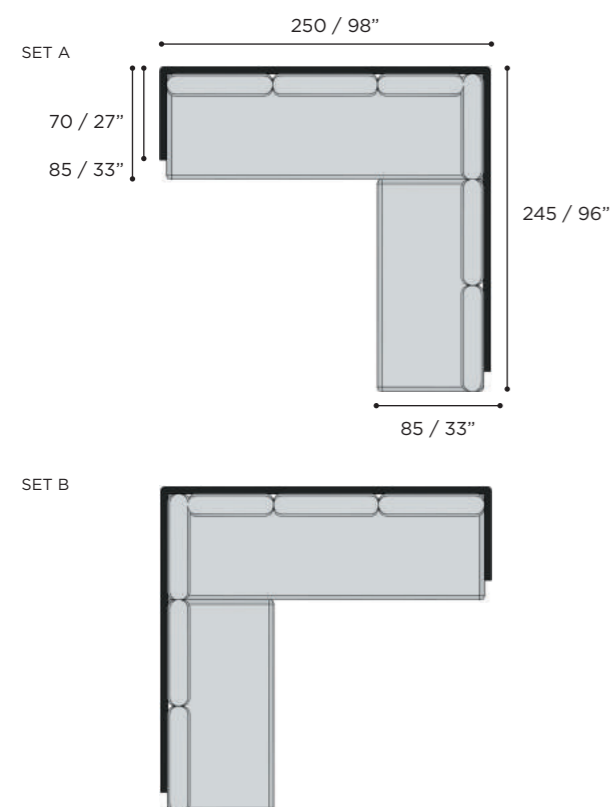

	COATED ALUMINIUM WR	COATED ALUMINIUM S	COATED ALUMINIUM A
BATYLINE	WU ALRL 04 A WRWU		
	WU ALRL 04 B WRWU		
	PG ALRL 04 A SPG		
	PG ALRL 04 B SPG		
	ZU		ALRL 04 A AZU
	ZU		ALRL 04 B AZU
	CUSHIONS		
	PIL ALRL 04 AB SET ED... (8 pcs)		
STANDARD			
CAT. A			
CAT. B			

ALURA LOUNGE SET 06

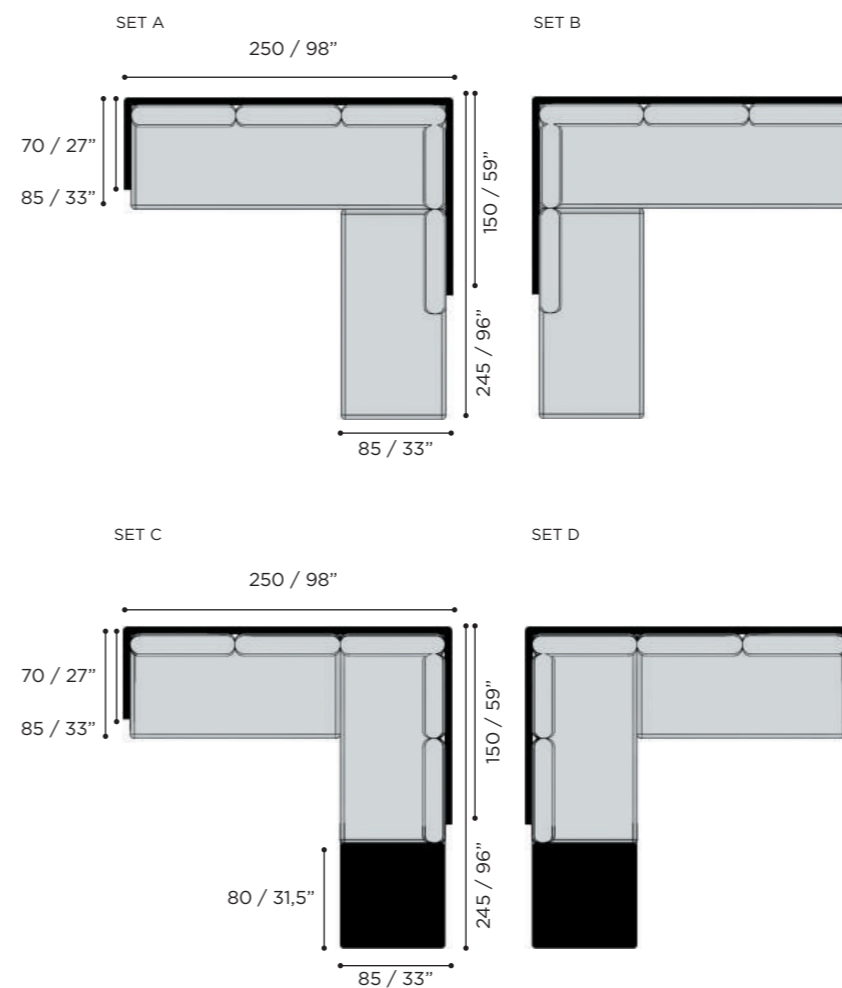

	COATED ALUMINIUM WR	COATED ALUMINIUM S	COATED ALUMINIUM A
BATYLINE	WU ALRL 06 A WRWU		
	WU ALRL 06 B WRWU		
	WU ALRL 06 C WRWU		
	WU ALRL 06 D WRWU		
	PG ALRL 06 A SPG		
	PG ALRL 06 B SPG		
	PG ALRL 06 C SPG		
	PG ALRL 06 D SPG		
	ZU		ALRL 06 A AZU
	ZU		ALRL 06 B AZU
	ZU		ALRL 06 C AZU
	ZU		ALRL 06 D AZU
	CUSHIONS		
	PIL ALRL 06 AB SET ED... (7 pcs)		
STANDARD			
CAT. A			
CAT. B			
	PIL ALRL 06 CD SET ED... (7 pcs)		
STANDARD			
CAT. A			
CAT. B			
	TABLE TOPS		
TOP (SET C + D)	ALRL 80 TOP G... **		

ALURA LOUNGE SET 07

SET A

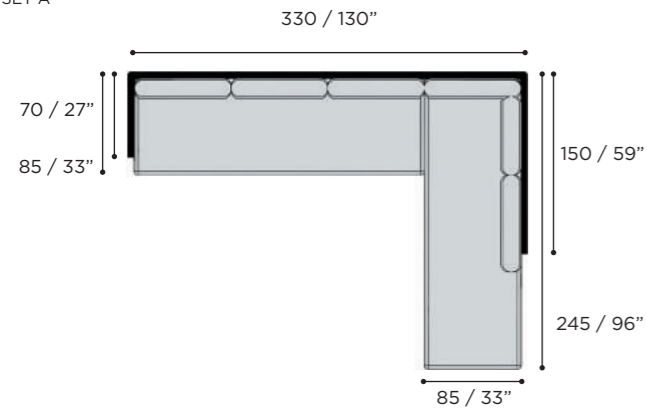

SET B

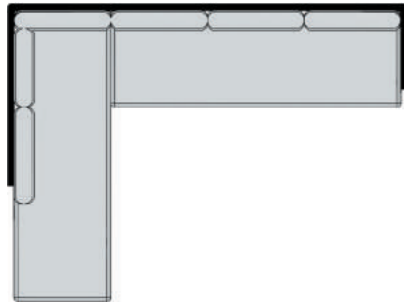

	COATED ALUMINIUM WR	COATED ALUMINIUM S	COATED ALUMINIUM A
WU	ALRL 07 A WRWU		
WU	ALRL 07 B WRWU		
PG	ALRL 07 A SPG		
PG	ALRL 07 B SPG		
ZU			ALRL 07 A AZU
ZU			ALRL 07 B AZU
CUSHIONS			
PIL ALRL 07 AB SET ED... (8 pcs)			
STANDARD			
CAT. A			
CAT. B			

ALURA LOUNGE SET 09

SET A

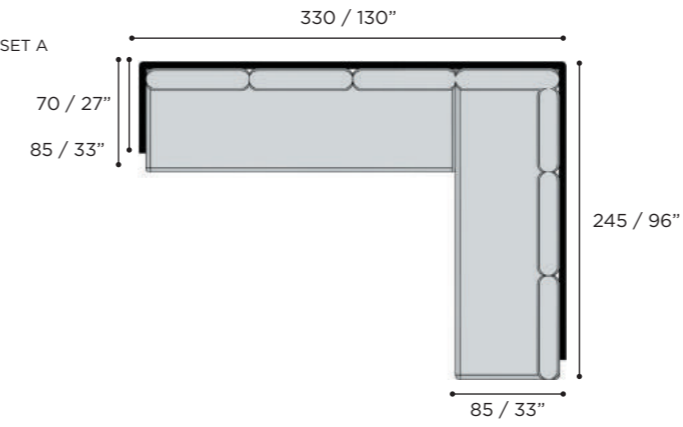

SET B

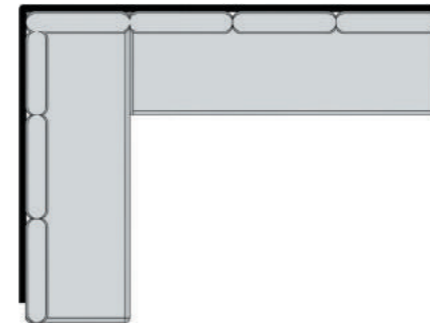

	COATED ALUMINIUM WR	COATED ALUMINIUM S	COATED ALUMINIUM A
WU	ALRL 09 A WRWU		
WU	ALRL 09 B WRWU		
PG	ALRL 09 A SPG		
PG	ALRL 09 B SPG		
ZU			ALRL 09 A AZU
ZU			ALRL 09 B AZU
CUSHIONS			
PIL ALRL 09 AB SET ED... (9 pcs)			
STANDARD			
CAT. A			
CAT. B			

ALURA LOUNGE SET 08

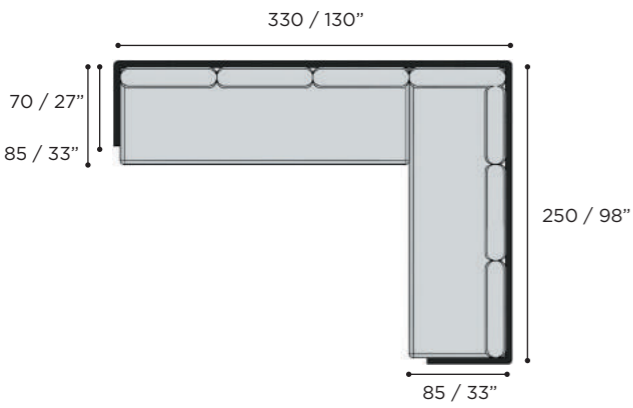

	COATED ALUMINIUM WR	COATED ALUMINIUM S	COATED ALUMINIUM A
WU	ALRL 08 WRWU		
PG	ALRL 08 SPG		
ZU			ALRL 08 AZU
CUSHIONS			
PIL ALRL 08 SET ED... (9 pcs)			
STANDARD			
CAT. A			
CAT. B			

ALURA LOUNGE SET 10

SET A

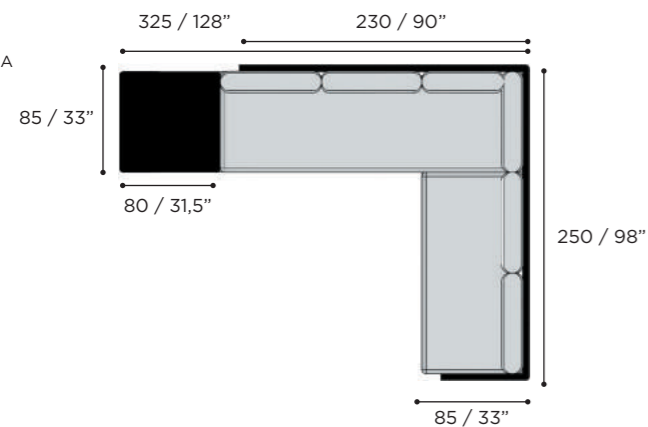

SET B

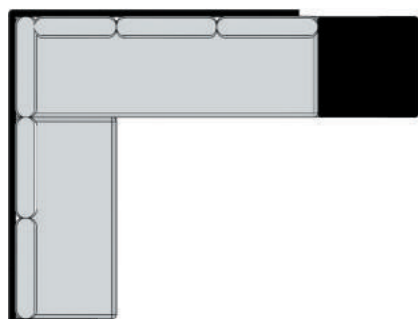

	COATED ALUMINIUM WR	COATED ALUMINIUM S	COATED ALUMINIUM A
WU	ALRL 10 A WRWU		
WU	ALRL 10 B WRWU		
BATYLINE PG	ALRL 10 A SPG		
BATYLINE PG	ALRL 10 B SPG		
ZU		ALRL 10 A AZU	
ZU		ALRL 10 B AZU	
CUSHIONS			
PIL ALRL 10 AB SET ED... (8 pcs)			
STANDARD			
CAT. A			
CAT. B			
TABLE TOPS			
TOP (SET A + B)	ALRL 80 TOP G... **		

** FOR MORE TABLE TOP OPTIONS SEE PP 137

ALURA LOUNGE SET 11

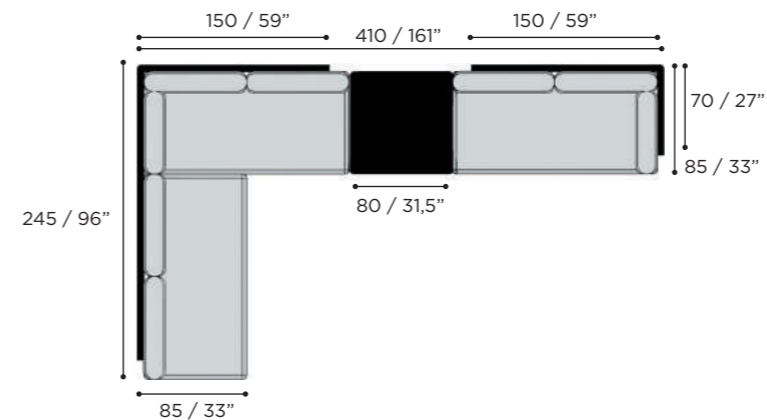

	COATED ALUMINIUM WR	COATED ALUMINIUM S	COATED ALUMINIUM A
WU	ALRL 11 WRWU		
BATYLINE PG	ALRL 11 SPG		
BATYLINE ZU		ALRL 11 AZU	
CUSHIONS			
PIL ALRL 11 SET ED... (11 pcs)			
STANDARD			
CAT. A			
CAT. B			
TABLE TOPS			
TOP	ALRL 80 TOP G... **		

** FOR MORE TABLE TOP OPTIONS SEE PP 137

ALURA LOUNGE SET 12

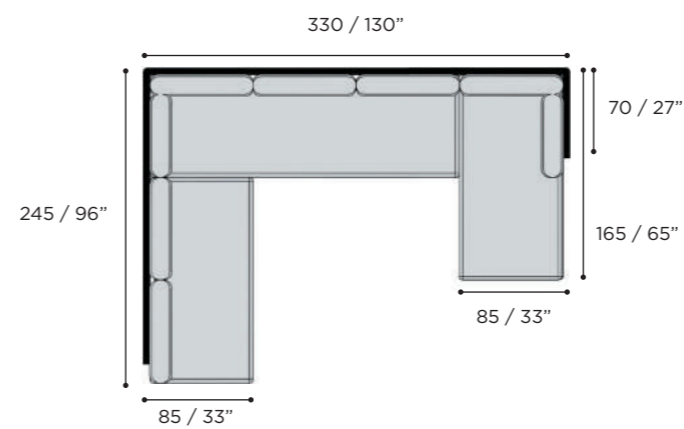

	COATED ALUMINIUM WR	COATED ALUMINIUM S	COATED ALUMINIUM A
WU	ALRL 12 WRWU		
BATYLINE PG	ALRL 12 SPG		
BATYLINE ZU		ALRL 12 AZU	
CUSHIONS			
PIL ALRL 12 SET ED... (11 pcs)			
STANDARD			
CAT. A			
CAT. B			

BEACHER

design by Kris Van Puyvelde

FOLDABLE CHAIR - BEA65...

0,10 m³ 6 kg

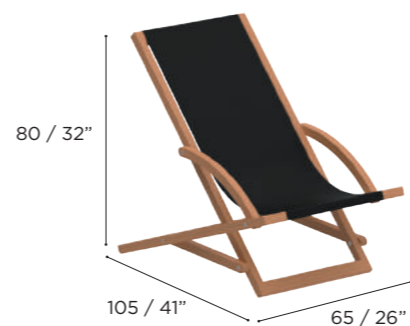

TEAK	
TK	
TEXTILE*	BEA 65 ...
CUSHIONS	
PIL BEA 65 ...	
CAT. A	•
BATYLINE**	BEA 65 T ...
CUSHIONS	
PIL BEA 65 T...	
CAT. A	•
PP 20, 21	

*TEXTILE (Example: BEA 65 WU)

WU	EU	ROU	MU	CAU	CHU	ZU

**BATYLINE (Example: BEA 65 TWU)

WU	EU	CAU	BRU	ZU	TQF	ORU

FOLDABLE FOOT REST - BEAF65...

0,03 m³ 2,2 kg

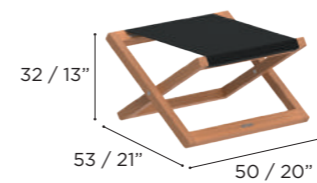

TEAK	
TK	
TEXTILE*	BEA F65 ...
•	
BATYLINE**	BEA F65 T ...
•	

*TEXTILE (Example: BEA F65 WU)

WU	EU	ROU	MU	CAU	CHU	ZU

**BATYLINE (Example: BEA F65 TWU)

WU	EU	CAU	BRU	ZU	TQF	ORU



DEL REY

design by Kris Van Puyvelde

FOLDING CHAIR - DEL47

0,08 m³ 7 kg



TEAK

TK

DEL 47

CUSHIONS

PIL DEL 47..

CAT. A

CAT. B

PP 22 - 23

FOLDING ARM CHAIR - DEL55

0,11 m³ 8,6 kg

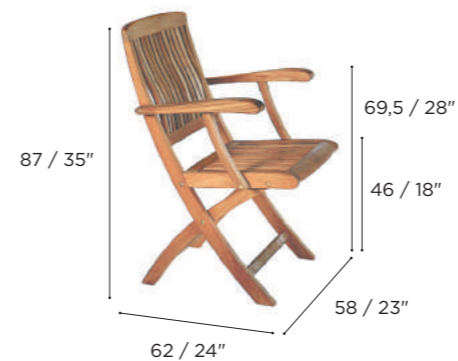

TEAK

TK

DEL 55

CUSHIONS

PIL DEL 55..

CAT. A

CAT. B

PP 22 - 23



DISCUS

design by Kris Van Puyvelde

ROUND TABLE WITH UMBRELLA HOLE - DSC130...



	STAINLESS STEEL BRUSHED	STAINLESS STEEL ELECTRO POLISHED	COATED ALUMINIUM	COATED ALUMINIUM	COATED ALUMINIUM	TEAK
		EP	WR	S	A	TK
WU	DSC 130 GSSWU	DSC 130 GSSEPWU	DSC 130 GWRWU			DSC 130 GWU
GLASS	DSC 130 GSSCLU	DSC 130 GSSEPCLU				DSC 130 GCLU
PG	DSC 130 GSSPG	DSC 130 GSSEP PG		DSC 130 GSPG		DSC 130 GPG
ZU	DSC 130 GSSZU	DSC 130 GSSEPZU			DSC 130 GAZU	DSC 130 GZU
TEAK	DSC 130 WSS	DSC 130 WSSEP	DSC 130 WWR	DSC 130 WS	DSC 130 WA	DSC 130

PP 22 - 23, 24 - 25



ROUND TABLE WITH UMBRELLA HOLE - DSC160...

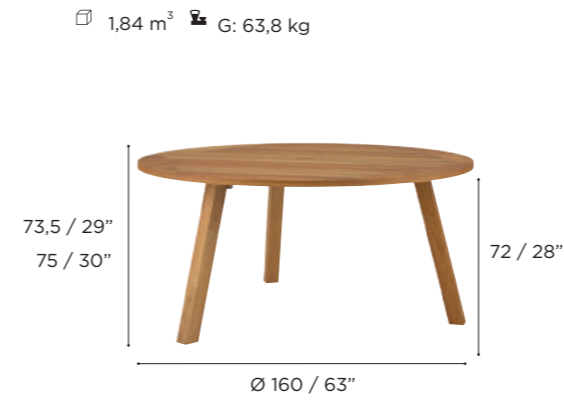

	STAINLESS STEEL BRUSHED	STAINLESS STEEL ELECTRO POLISHED	COATED ALUMINIUM	COATED ALUMINIUM	COATED ALUMINIUM	TEAK
		EP	WR	S	A	TK
WU	DSC 160 GSSWU	DSC 160 GSSEPWU	DSC 160 GWRWU			DSC 160 GWU
GLASS	DSC 160 GSSCLU	DSC 160 GSSEPCLU				DSC 160 GCLU
PG	DSC 160 GSSPG	DSC 160 GSSEP PG		DSC 160 GSPG		DSC 160 GPG
ZU	DSC 160 GSSZU	DSC 160 GSSEPZU			DSC 160 GAZU	DSC 160 GZU
TEAK	DSC 160 WSS	DSC 160 WSSEP	DSC 160 WWR	DSC 160 WS	DSC 160 WA	DSC 160

ROUND TABLE WITHOUT UMBRELLA HOLE - DSC130...

1,21 m³ W: 29 kg



	STAINLESS STEEL BRUSHED	STAINLESS STEEL ELECTRO POLISHED	COATED ALUMINIUM	COATED ALUMINIUM	COATED ALUMINIUM	TEAK
	WU	EP	WR	S	A	TK
GLASS	DSC 130 GSSWUZ	DSC 130 GSSEPWUZ	DSC 130 GWRWUZ			DSC 130 GWUZ
CLU	DSC 130 GSSCLUZ	DSC 130 GSSEPCLUZ				DSC 130 GCLUZ
PG	DSC 130 GSSPGZ	DSC 130 GSSEPPGZ		DSC 130 GSPGZ		DSC 130 GPGZ
ZU	DSC 130 GSSZUZ	DSC 130 GSSEPZUZ			DSC 130 GAZUZ	DSC 130 GZUZ



ROUND TABLE WITHOUT UMBRELLA HOLE - DSC160...

1,84 m³ G: 63,8 kg

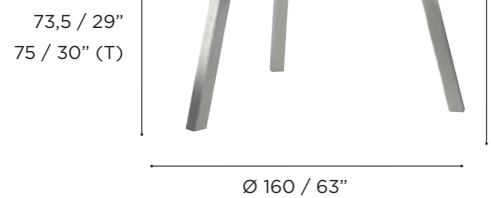

	STAINLESS STEEL BRUSHED	STAINLESS STEEL ELECTRO POLISHED	COATED ALUMINIUM	COATED ALUMINIUM	COATED ALUMINIUM	TEAK
	WU	EP	WR	S	A	TK
GLASS	DSC 160 GSSWUZ	DSC 160 GSSEPWUZ	DSC 160 GWRWUZ			DSC 160 GWUZ
CLU	DSC 160 GSSCLUZ	DSC 160 GSSEPCLUZ				DSC 160 GCLUZ
PG	DSC 160 GSSPGZ	DSC 160 GSSEPPGZ		DSC 160 GSPGZ		DSC 160 GPGZ
ZU	DSC 160 GSSZUZ	DSC 160 GSSEPZUZ			DSC 160 GAZUZ	DSC 160 GZUZ

FOLIA

design by Kris Van Puyvelde

CHAIR - FOL55...

0,21 m³ 6,6 kg

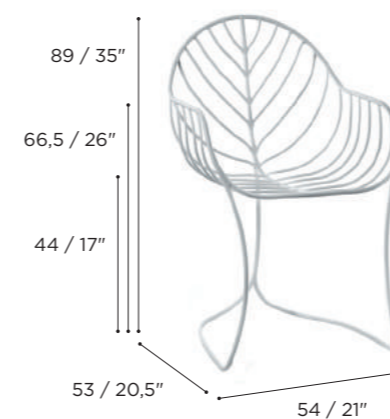

COATED STAINLESS STEEL

WR

FOL 55 WR

COATED STAINLESS STEEL

BR

FOL 55 BR

CUSHIONS

PIL FOL55RS...

CAT. A

CAT. B

PP 26, 27, 28 - 29

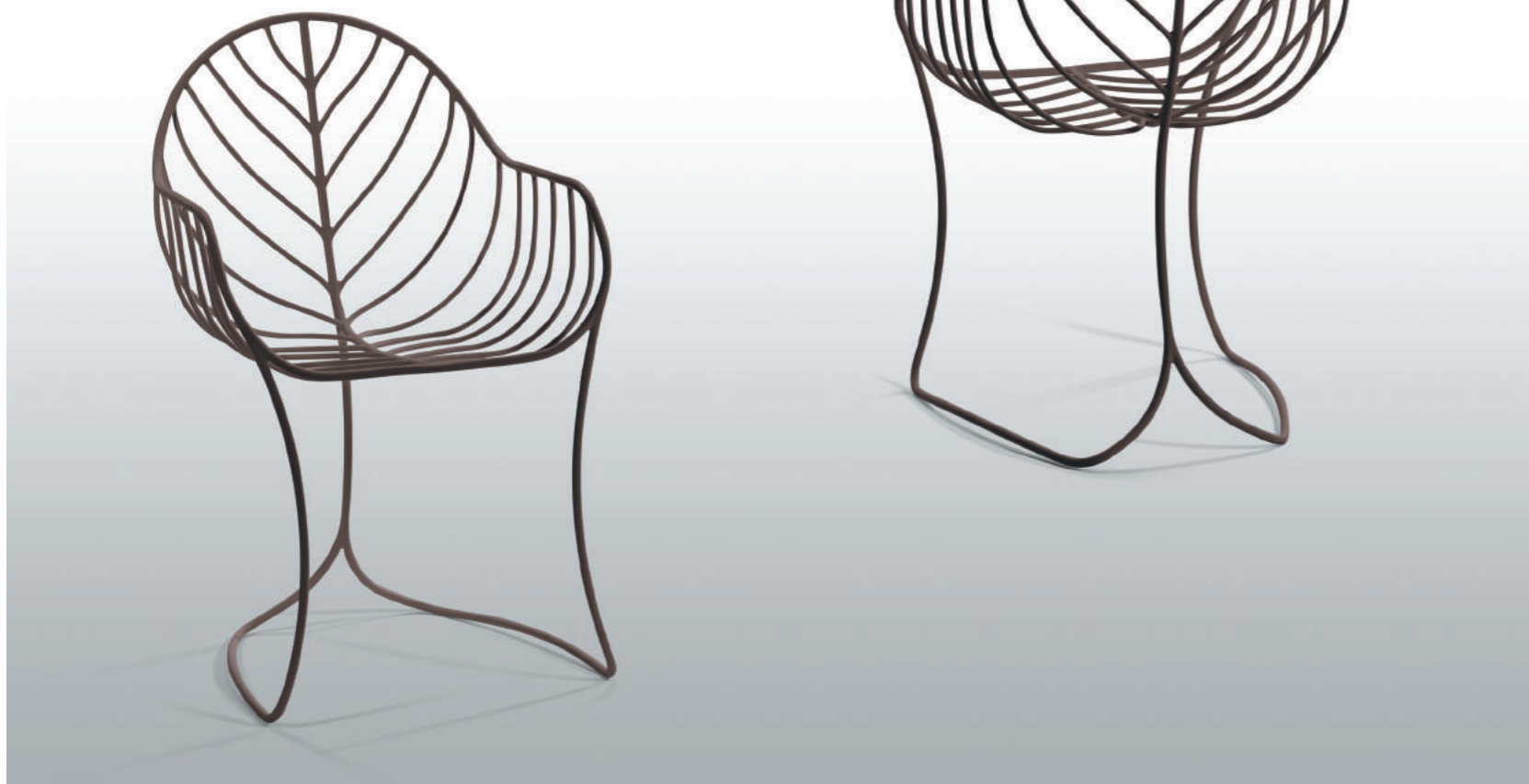

IXIT

design by Kris Van Puyvelde

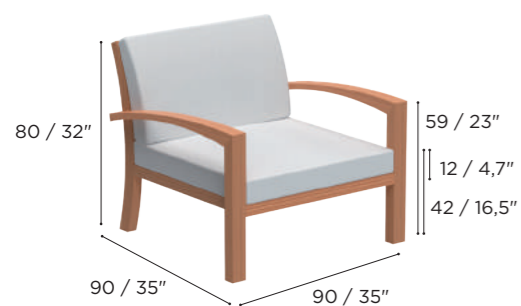

LOUNGE ONE SEATER - IXIT77

0,85 m³ 24 kg

LOUNGE FOOTREST - IXIT70T

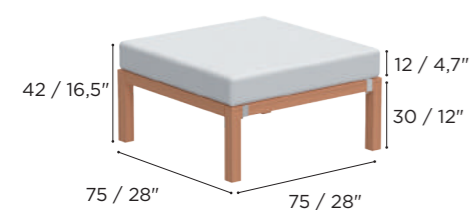
0,06 m³ 12 kg

LOUNGE BENCH - IXIT210

1,26 m³ 57,4 kg

LOW TABLE - IXIT150T

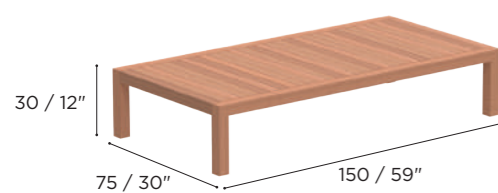
0,15 m³ 21 kg

TEAK
TK
IXIT 77
•
CUSHIONS
PIL IXIT 70... (2pcs)
CAT. A •
CAT. B •
PP 33

TEAK
TK
IXIT 70T
•
CUSHIONS
PIL IXIT 70T... (1pc)
CAT. A •
CAT. B •

TEAK
TK
IXIT 210
•
CUSHIONS
PIL IXIT 210... (4pcs)
CAT. A •
CAT. B •
CUSHIONS
3x PIL IXIT 70... (6pcs)
CAT. A •
CAT. B •
PP 32, 33

TEAK
TK
IXIT 150T
•
PP 33

ARM CHAIR - IXIT55

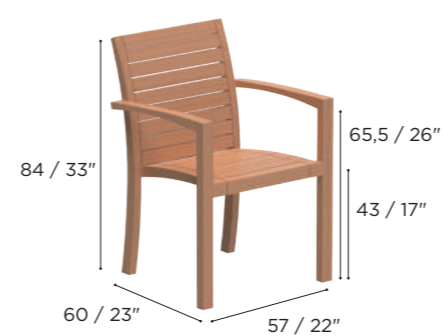
0,51 m³ (2) 9 kg

LOUNGE CHAIR - IXIT195

0,59 m³ (2) 32 kg

BENCH - IXIT118

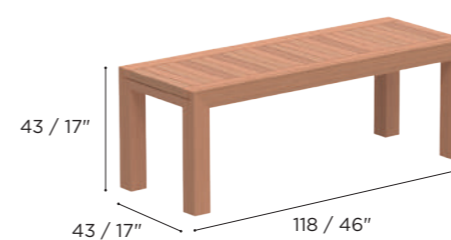
0,23 m³ 15,5 kg

STOOL - IXIT43

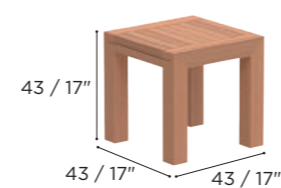
0,08 m³ 8,5 kg

TEAK
TK
IXIT 55
•
CUSHIONS
PIL IXIT 55...
CAT. A •
CAT. B •

TEAK
TK
IXIT 195
•
CUSHIONS
PIL IXIT 195...
CAT. A •
CAT. B •
PP 34 - 35

TEAK
TK
IXIT 118
•
CUSHIONS
PIL IXIT 118...
CAT. A •
CAT. B •
PP 31

TEAK
TK
IXIT 43
•
CUSHIONS
PIL IXIT 43...
CAT. A •
CAT. B •
PP 30, 31

BENCH - IXIT178

0,35 m³ 22 kg

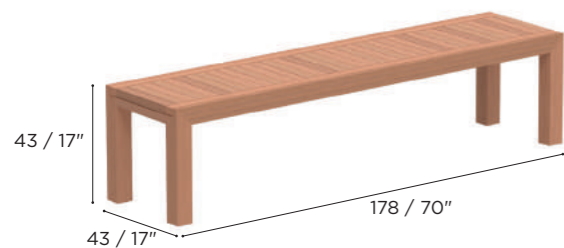

TEAK

TK

IXIT 178

CUSHIONS

PIL IXIT 178..

CAT. A

CAT. B

TABLE - IXIT200

0,38 m³ 54 kg



TEAK

TK

IXIT 200

TABLE - IXIT260

0,72 m³ 78 kg

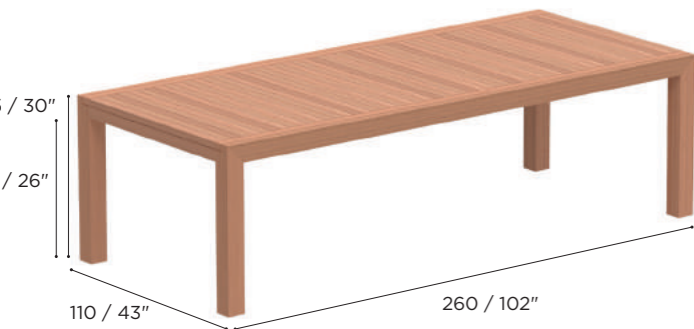

TEAK

TK

IXIT 260

PP 31

TABLE - IXIT320

0,72 m³ 93 kg



TEAK

TK

IXIT 320

EXTENDABLE TABLE - IXIT270

1,13 m³ 73 kg

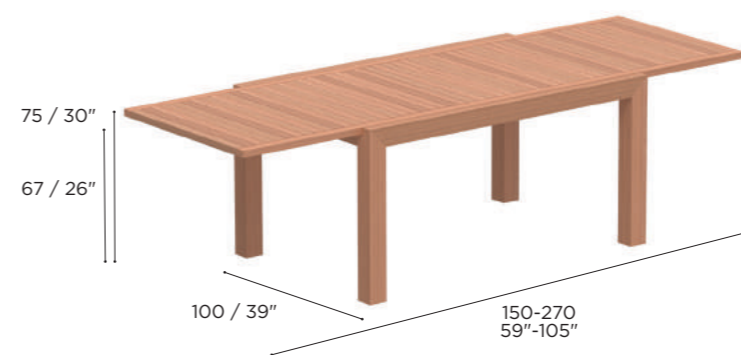

TEAK

TK

IXIT 270

EXTENDABLE TABLE - IXIT360

1,8 m³ 86 kg

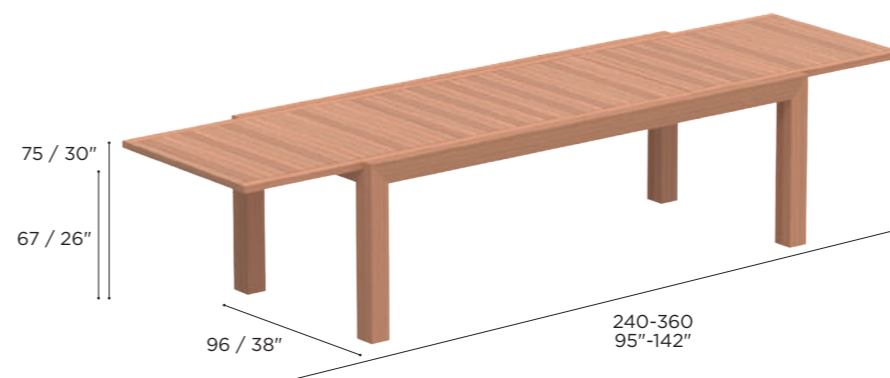

TEAK

TK

IXIT 360

TROLLEY - IXIT T

0,41 m³ 40 kg

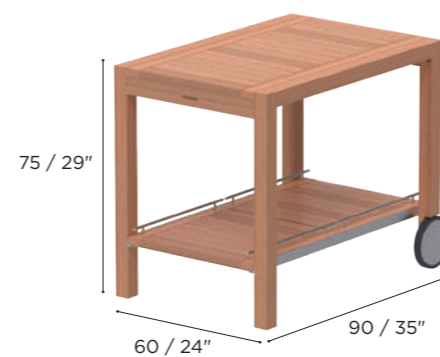

TEAK

TK

IXIT T

JIVE

design by Kris Van Puyvelde

CHAIR - JIV55...

0,21 m³ 6,6 kg



COATED ALUMINIUM + TEAK COATED ALUMINIUM + TEAK COATED ALUMINIUM + TEAK COATED ALUMINIUM + TEAK

WR TK S TK A TK BR TK

OLEFIN FIBER JIV 55 WGWR JIV 55 WGS JIV 55 WGA JIV 55 WGBR

CUSHIONS

PIL JIV 55RS... (SEAT + BACK)

CAT. A

CAT. B

PIL JIV 55RS... (SEAT)

CAT. A

CAT. B

PP 36, 38, 39, 90 - 91, 122, 123



KOKOON

design by Olivier Le Pensec



HAMMOCK - KKN260...

0,97 m³ 83 kg

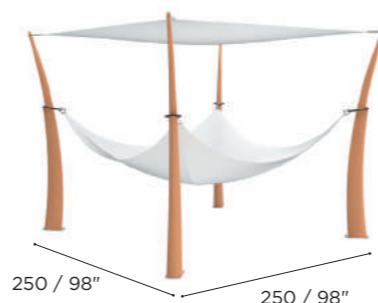

250 / 98" 250 / 98"

EMBEDDED BASE - KKNG

0,29 m³ 109 kg



233 x 233
92" x 92"

TERRACE BASE - KKNT

0,29 m³ 112 kg



257 x 257
101" x 101"

CURTAIN SET - KKNC

0,01 m³ 1,5 kg

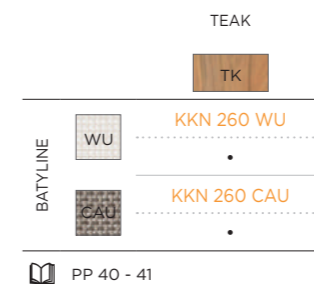

PP 40 - 41



X-FRAME EMBEDDING IN GROUND
CADRE POUR INTEGRER AU ISOL
STRUKTUR FÜR EINBAU IM BODEN
STRUCTUUR VOOR PLAATSING ONDERGRONDS
STRUTTURA DA INTERRARE
ESTRUCTURA PARA ENTERRARIA

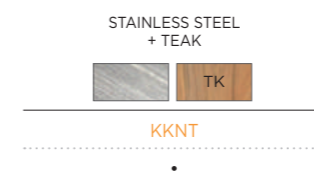

BASE FOR MOUNTING ON TERRACE
BASE POUR MONTAGE SUR TERRASSE
BASIS FÜR MONTAGE AUF TERRASSE
BASIS VOOR PLAATSING OP TERRAS
STRUTTURA DA APPOGGIARE SULLA TERRAZZA
ESTRUCTURA PARA PONERLA EN LA TERRAZZA

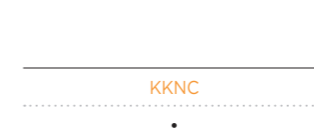

CURTAIN SET
VOILLAGE
VORHANG SET
GORDIJNSET
SET DI TENDE
JUEGO DE CORTINAS

LAZY

design by Kris Van Puyvelde



LOUNGE MODULE - LZ80...

0,19 m³ 14 kg



COATED ALUMINIUM

BR

TEXTILE BR LZ 80 BRMAFL

PP 42 - 43

LOUNGE MODULE - LZ100S...

0,58 m³ 51 kg



COATED ALUMINIUM

BR

TEXTILE BR LZ 100 BRMAFL

PP 42 - 43

LOUNGE MODULE - LZ100...

0,24 m³ 16,8 kg

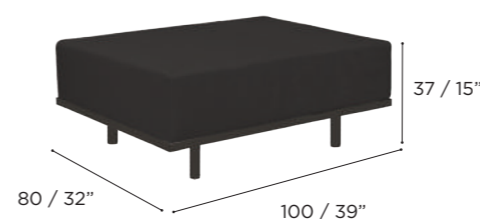

COATED ALUMINIUM

BR

TEXTILE BR LZ 160 BRMAFL

PP 42 - 43

LOUNGE MODULE - LZ160...

0,49 m³ 23,5 kg

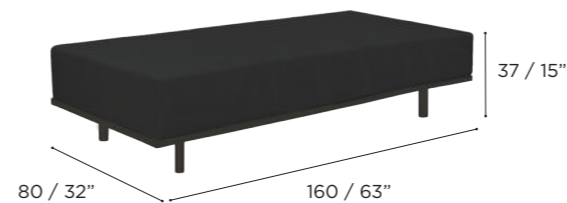

COATED ALUMINIUM

BR

TEXTILE BR LZ 80C BRMAFL

PP 42 - 43, 44 - 45

LOUNGE CORNER MODULE - LZ80C...

0,49 m³ 35 kg



COATED ALUMINIUM

BR

TEXTILE BR LZ 100V MAFL

PP 42 - 43, 44 - 45

BACK REST MODULE - LZ65V...

0,05 m³ 4,4 kg

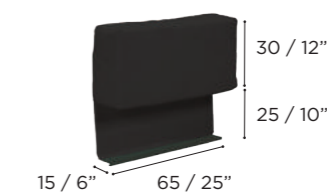

COATED ALUMINIUM

BR

TEXTILE BR LZ 80V MAFL

PP 42 - 43

BACK REST MODULE - LZ80V...

0,07 m³ 6,1 kg

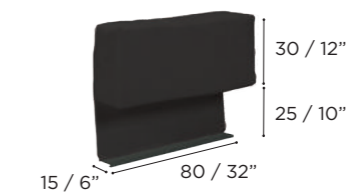

COATED ALUMINIUM

BR

TEXTILE BR LZ 100V MAFL

PP 42 - 43, 44 - 45

BACK REST MODULE - LZ100V...

0,08 m³ 7,8 kg

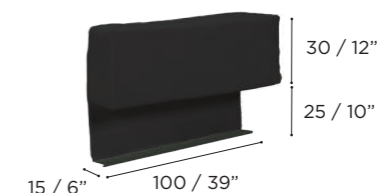

COATED ALUMINIUM

BR

TEXTILE BR LZ 65H MAFL

PP 42 - 43

BACK REST MODULE - LZ65H...

0,06 m³ 4,4 kg

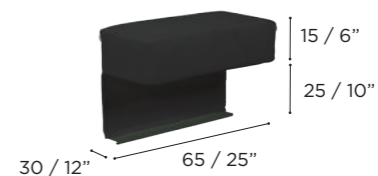

LAZY LOUNGE SET BRONZE 01



LZ SET 01

INCLUDED

- 1 x LZ 160
- 2 x LZ 80V
- 2 x LZ 65V
- 2 x PIL 40 (CAT. A)

LAZY LOUNGE SET BRONZE 03



LZ SET 03

INCLUDED

- 2 x LZ 160
- 1 x LZ 100V
- 3 x LZ 80V
- 4 x PIL 40 (CAT. A)

LAZY LOUNGE SET BRONZE 02



LZ SET 02

INCLUDED

- 2 x LZ 100
- 2 x LZ 100V
- 2 x LZ 65H
- 2 x PIL 40 (CAT. A)

LAZY LOUNGE SET BRONZE 04



LZ SET 04

INCLUDED

- 3 x LZ 160
- 6 x LZ 80V
- 1 x LZ 65V
- 2 x LZ 65H
- 6 x PIL 40 (CAT. A)

LUSIT LOUNGE

design by Kris Van Puyvelde & Frank Boschman

STANDARD OFFER FOR LUSIT LOUNGE COLLECTION (CATEGORY B FABRICS)

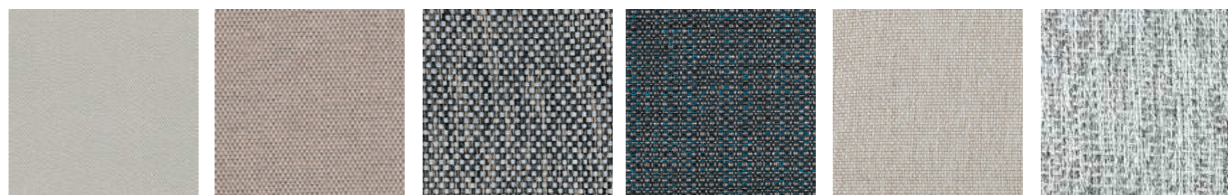

FROST LINEN
LAMINATED
ref: FLL

DESERT STONE
FLAX LAMINATED
ref: DSFL

CHARCOAL
DOT
ref: NCD

AQUA GREY
TWIN
ref: NAGT

WHITE
DOT
ref: NWD

NATURAL
SILVER DOT
ref: NSD

ALL OTHER FABRICS AVAILABLE ON REQUEST - PP 270 - 273



LUSIT BACKREST - LUS60V...

0,05 m³ 3,5 kg



COATED ALUMINIUM + WOVEN ROPE	COATED ALUMINIUM + WOVEN ROPE
BR	WR
LUS 60 VBRBR	LUS 60 VVRWU

PP 46 - 47, 48 - 49

LUSIT MODULAR LOUNGE ELEMENT / TABLE - LUS80B...

0,15 m³ 5,5 kg



COATED ALUMINIUM + WOVEN ROPE	COATED ALUMINIUM + WOVEN ROPE
BR	WR
LUS 80 BBRBR	LUS 80 BWRWU

PP 46 - 47, 48 - 49

LUSIT MODULAR LOUNGE ELEMENT / TABLE - LUS160B...

0,30 m³ 10,5 kg

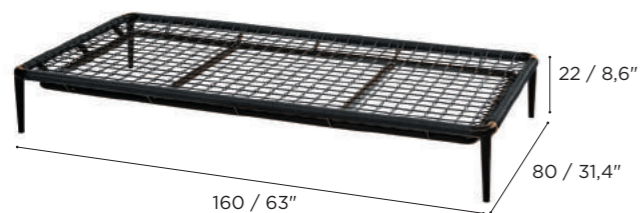

COATED ALUMINIUM + WOVEN ROPE	COATED ALUMINIUM + WOVEN ROPE
BR	WR
LUS 160 BBRBR	LUS 160 BWRWU

PP 46 - 47, 48 - 49

LUSIT / ALURA LOUNGE CUSHIONS

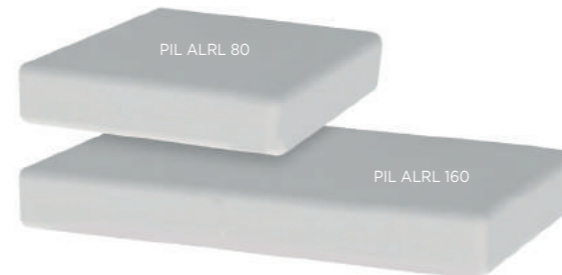

LUSIT / ALURA LOUNGE TABLE TOPS

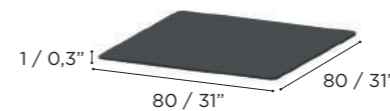

CUSHIONS FOR LUSIT LOUNGE	
	PIL ALRL 60 V ... ARM 60 x 40
STANDARD	•
CAT. A	•
CAT. B	•
	PIL ALRL 65 V ... BACK / ARM 65 x 40
STANDARD	•
CAT. A	•
CAT. B	•
	PIL ALRL 80 V ... BACK / ARM 80 x 40
STANDARD	•
CAT. A	•
CAT. B	•

CUSHIONS FOR LUSIT LOUNGE	
	PIL ALRL 80 ... SEAT 80 x 80
STANDARD	•
CAT. A	•
CAT. B	•
	PIL ALRL 160 ... SEAT 160 x 80
STANDARD	•
CAT. A	•
CAT. B	•

	ALURA LOUNGE TABLE TOP 80 x 80	ALURA LOUNGE TABLE TOP 160 x 80
GLASS	WU ALRL 80 TOP GWU	ALRL 160 TOP GWU
	ZU ALRL 80 TOP GZU	ALRL 160 TOP GZU
CERAMIC	WUM ALRL 80 TOP CWUM	ALRL 160 TOP CWUM
	ZUM ALRL 80 TOP CZUM	ALRL 160 TOP CZUM
TEAK	TK ALRL 80 TOP W	

LUSIT LOUNGE SET 01



LUS SET 01

INCLUDED

- 2 x LUS 160BBRBR
- 5 x LUS 60VBRBR
- 2 x PIL ALRL160 (STANDARD CAT.)
- 4 x PIL ALRL80V (STANDARD CAT.)
- 1 x PIL ALRL65V (STANDARD CAT.)

* = PRICE FOR BRONZE COATED ALUMINIUM FRAME AND STANDARD CUSHIONS (CAT. B)

LUSIT LOUNGE SET 03



LUS SET 03

INCLUDED

- 2 x LUS 160BBRBR
- 1 x LUS 80BBRBR
- 6 x LUS 60VBRBR
- 2 x PIL ALRL160 (STANDARD CAT.)
- 4 x PIL ALRL80V (STANDARD CAT.)
- 2 x PIL ALRL65V (STANDARD CAT.)
- 1 x ALRL 80TOPW

* = PRICE FOR BRONZE COATED ALUMINIUM FRAME AND STANDARD CUSHIONS (CAT. B)

LUSIT LOUNGE SET 02



LUS SET 02

INCLUDED

- 2 x LUS 160BBRBR
- 5 x LUS 60VBRBR
- 2 x PIL ALRL160 (STANDARD CAT.)
- 4 x PIL ALRL80V (STANDARD CAT.)
- 1 x PIL ALRL65V (STANDARD CAT.)

* = PRICE FOR BRONZE COATED ALUMINIUM FRAME AND STANDARD CUSHIONS (CAT. B)

LUSIT LOUNGE SET 04



LUS SET 04

INCLUDED

- 3 x LUS 160BBRBR
- 8 x LUS 60VBRBR
- 3 x PIL ALRL160 (STANDARD CAT.)
- 6 x PIL ALRL80V (STANDARD CAT.)
- 2 x PIL ALRL65V (STANDARD CAT.)

* = PRICE FOR BRONZE COATED ALUMINIUM FRAME AND STANDARD CUSHIONS (CAT. B)

NEW ENGLAND

design by Pierre Stelmazyk

LOUNGE CHAIR - NEH 85TK

0,16 m³ 24 kg

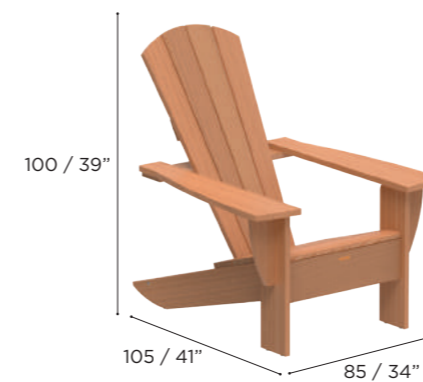

TEAK
TK
NEH 85 TK
•
CUSHIONS
PIL NEH... (HEAD)
CAT. A •
CAT. B •
PIL NE85... (SEAT)
CAT. A •
CAT. B •
PIL NE85H... (SEAT & BACK)
CAT. A •
CAT. B •
PP 50, 51



WHEEL SET - NE W

0,01 m³ 1 kg



TEAK
TK
NE W TK
•

FOOTREST - NE56

0,02 m³ 2 kg

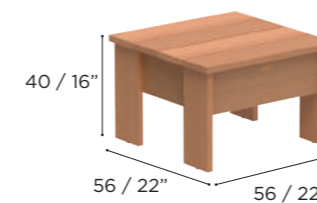

TEAK
TK
NE 56 TK
•
PP 51



NINIX

design by Kris Van Puyvelde

ARM CHAIR - NNX55

0,28 m³ 10 kg



	STAINLESS STEEL BRUSHED	STAINLESS STEEL ELECTRO POLISHED
TEAK	TK	EP
	NNX 55	NNX 55 EP
CUSHIONS		
PIL NNX 55 ...		
CAT. A		
CAT. B		
PP 52, 53		

STORAGE BOX - NNXSBL...

0,96 m³ 110 kg



	STAINLESS STEEL BRUSHED	STAINLESS STEEL ELECTRO POLISHED
TEAK	TK	EP
	NNX SBL	NNX SBL EP

TOWEL RACK - NNXTR...

0,35 m³ 9 kg

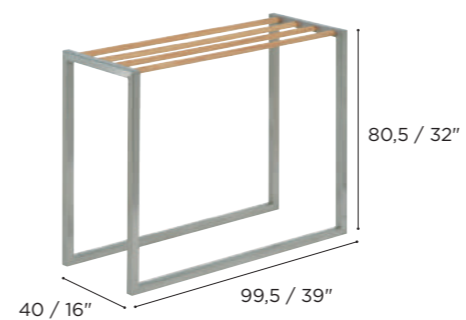

	STAINLESS STEEL BRUSHED	STAINLESS STEEL ELECTRO POLISHED	COATED ALUMINIUM	COATED ALUMINIUM	COATED ALUMINIUM
TEAK	TK	EP	W	S	A
	NNX TR	NNX TR EP	NNX TR W	NNX TR S	NNX TR A



ARM CHAIR - NNX55T...

0,29 m³ 10 kg

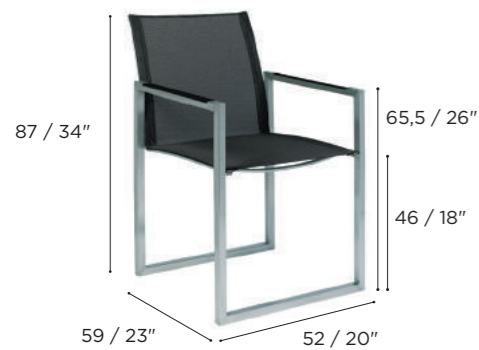

	STAINLESS STEEL BRUSHED	STAINLESS STEEL ELECTRO POLISHED	COATED STAINLESS STEEL	COATED STAINLESS STEEL	COATED STAINLESS STEEL	COATED STAINLESS STEEL
WU	NNX 55 TWU	NNX 55 TEPWU	NNX 55 TWWU			
CAU	NNX 55 TCAU	NNX 55 TEPCAU				
PG			NNX 55 TSPG			
TZU	NNX 55 TZU	NNX 55 TEPZU		NNX 55 TAZU		
BR					NNX 55 T BRBR	
OPTIONAL TEAK ARMRESTS	NNX 55T ARWSET					
CUSHIONS						
PIL NNX55T ...						
CAT. A	•					
CAT. B	•					

PP 54, 57, 60, 61, 62 - 63

RELAX CHAIR - NNX77T...

0,33 m³ 12 kg

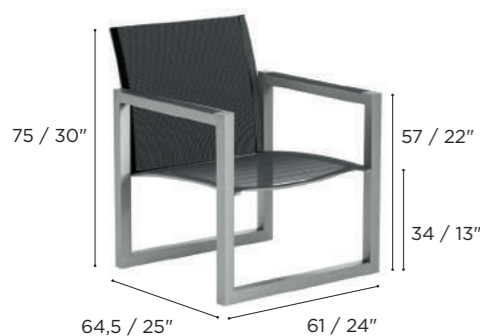

WU	NNX 77 TWU	NNX 77 TEPWU	NNX 77 TWWU			
CAU	NNX 77 TCAU	NNX 77 TEPCAU				
PG			NNX 77 TSPG			
TZU	NNX 77 TZU	NNX 77 TEPZU		NNX 77 TAZU		
BR					NNX 77 TBRBR	
OPTIONAL TEAK ARMRESTS	NNX 77T ARWSET					
CUSHIONS						
PIL NNX77T ...						
CAT. A	•					
CAT. B	•					

PP 66 - 67

FOOTREST - NNXFT...

0,14 m³ 9 kg



WU	NNX F TWU	NNX F TEPWU	NNX F TWWU			
CAU	NNX F TCAU	NNX F TEPCAU				
PG			NNX F TSPG			
TZU	NNX F TZU	NNX F TEPZU		NNX F TAZU		
BR					NNX F TBRBR	

LOW BENCH - NNX154T...

0,81 m³(2) 27 kg

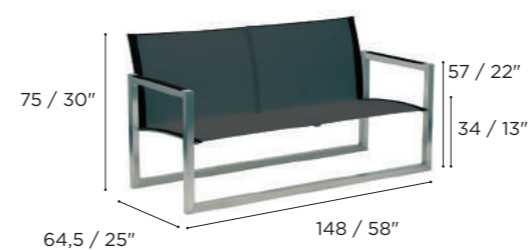

	STAINLESS STEEL BRUSHED	STAINLESS STEEL ELECTRO POLISHED	COATED STAINLESS STEEL	COATED STAINLESS STEEL	COATED STAINLESS STEEL	COATED STAINLESS STEEL
WU	NNX 154 TWU	NNX 154 TEPWU	NNX 154 TWWU			
CAU	NNX 154 TCAU	NNX 154 TEPCAU				
PG			NNX 154 TSPG			
TZU	NNX 154 TZU	NNX 154 TEPZU		NNX 154 TAZU		
BR					NNX 154 TBRBR	
OPTIONAL TEAK ARMRESTS	NNX 154T ARWSET					
CUSHIONS						
PIL NNX154T ...						
CAT. A	•					
CAT. B	•					

RELAX CHAIR - NNX60T...

0,5 m³(2) 15,2 kg INCL. HEADCUSHION

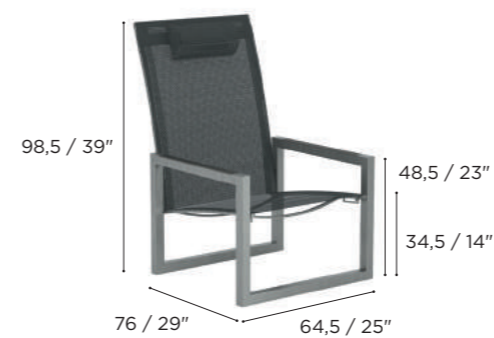

WU	NNX 60 TWU	NNX 60 TEPWU	NNX 60 TWWU			
CAU	NNX 60 TCAU	NNX 60 TEPCAU				
PG			NNX 60 TSPG			
TZU	NNX 60 TZU	NNX 60 TEPZU		NNX 60 TAZU		
BR					NNX 60 TBRBR	
OPTIONAL TEAK ARMRESTS	NNX 60T ARWSET					
CUSHIONS						
PIL NNX60T ...						
CAT. A	•					
CAT. B	•					

RELAX CHAIR - NNX65T...

0,54 m³ 20 kg INCL. HEADCUSHION

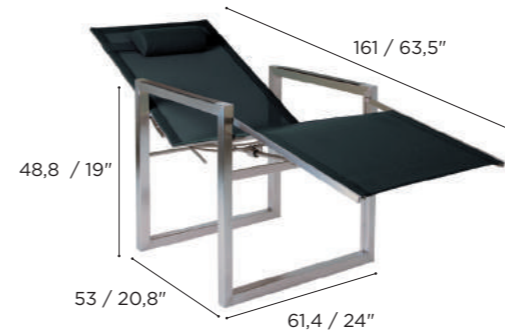

WU	NNX 65 TWU	NNX 65 TEPWU				
CAU	NNX 65 TCAU	NNX 65 TEPCAU				
TZU	NNX 65 TZU	NNX 65 TEPZU				
OPTIONAL TEAK ARMRESTS	NNX 65T ARWSET					
CUSHIONS						
PIL NNX 65 T ...						
CAT. A	•					
CAT. B	•					

BAR CHAIR - NNX43T...

0,29 m³ 11,8 kg

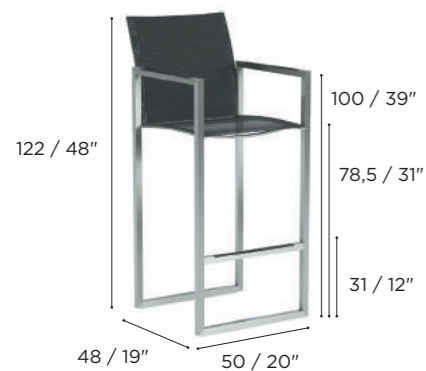

	STAINLESS STEEL BRUSHED	STAINLESS STEEL ELECTRO POLISHED	COATED STAINLESS STEEL	COATED STAINLESS STEEL	COATED STAINLESS STEEL	COATED STAINLESS STEEL
		EP	W	S	A	BR
WU	NNX 43 TWU	NNX 43 TEPWU	NNX 43 TWWU			
CAU	NNX 43 TCAU	NNX 43 TEPCAU				
BATYLINE			NNX 43 TSPG			
PG						
TZU	NNX 43 TZU	NNX 43 TEPZU		NNX 43 TAZU		
BR						NNX 43 TBRBR
OPTIONAL TEAK ARMRESTS			NNX 43T ARWSET			
CUSHIONS						
PIL NNX55T ...						
CAT. A						
CAT. B						

SIDE TABLE - NNX50...

0,13 m³ G/C: 10 kg - TK: 7,5 kg

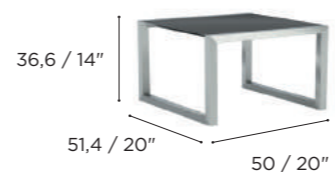

	STAINLESS STEEL BRUSHED	STAINLESS STEEL ELECTRO POLISHED	COATED STAINLESS STEEL	COATED STAINLESS STEEL	COATED STAINLESS STEEL	COATED STAINLESS STEEL
		EP	W	S	A	BR
GLASS	WU	NNX 50 GWU	NNX 50 GEPWU	NNX 50 GWWU		
	CLU	NNX 50 GCLU	NNX 50 GEPCLU			
	WU	NNX 50 CWU	NNX 50 CEPWU	NNX 50 CWWU		
	TG	NNX 50 CTG	NNX 50 CEPTG			
CERAMIC	PG			NNX 50 CSPG		
	VB					NNX 50 CBRVB
	ZU	NNX 50 CZU	NNX 50 CEPZU		NNX 50 CAZU	
TEAK	TK	NNX 50	NNX 50 EP	NNX 50 WW	NNX 50 WS	NNX 50 WA
						NNX 50 WBR

PP 54, 55, 58 - 59

LOUNGER - NNX195T...

0,69 m³ (2) 25 kg INCL. HEADCUSHION



	STAINLESS STEEL BRUSHED	STAINLESS STEEL ELECTRO POLISHED	COATED STAINLESS STEEL	COATED STAINLESS STEEL	COATED STAINLESS STEEL	COATED STAINLESS STEEL
		EP	W	S	A	BR
WU	NNX 195 TWU	NNX 195 TEPWU	NNX 195 TWWU			
CAU	NNX 195 TCAU	NNX 195 TEPCAU				
BATYLINE			NNX 195 TSPG			
PG						
TZU	NNX 195 TZU	NNX 195 TEPZU		NNX 195 TAZU		
BR						NNX 195 TBRBR
OPTIONAL TEAK ARMRESTS			NNX 195T ARWSET			
CUSHIONS						
PIL NNX195T ...						
CAT. A						
CAT. B						

PP 54, 55, 58 - 59

LOW TABLE - NNX90T...

0,33 m³ G/C: 32 kg - TK: 24 kg

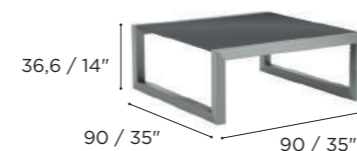

	STAINLESS STEEL BRUSHED	STAINLESS STEEL ELECTRO POLISHED	COATED ALUMINIUM	COATED ALUMINIUM	COATED ALUMINIUM	COATED ALUMINIUM
		EP	W	S	A	BR
GLASS	WU	NNX 90T GWU	NNX 90T GEPWU	NNX 90T GWWU		
	CLU	NNX 90T GCLU	NNX 90T GEPCLU			
	WU	NNX 90T CWU	NNX 90T CEPWU	NNX 90T CWWU		
	TG	NNX 90T CTG	NNX 90T CEPTG			
CERAMIC	PG			NNX 90T CSPG		
	VB					NNX 90T CBRVB
	ZU	NNX 90T CZU	NNX 90T CEPZU		NNX 90T CAZU	
TEAK	TK	NNX 90T	NNX 90T EP	NNX 90T WW	NNX 90T WS	NNX 90T WA
						NNX 90T WBR

LOW TABLE - NNX150T...

0,55 m³ G/C: 48 kg - TK: 33 kg

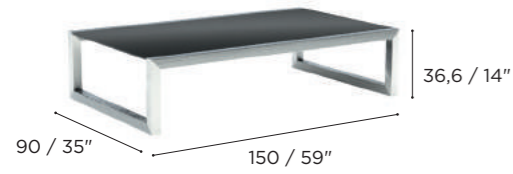

	STAINLESS STEEL BRUSHED	STAINLESS STEEL ELECTRO POLISHED	COATED ALUMINIUM	COATED ALUMINIUM	COATED ALUMINIUM	COATED ALUMINIUM	
	WU	EP	W	S	A	BR	
GLASS	WU	NNX 150T GEPWU	NNX 150T GWWU				
	CLU	NNX 150T GEPCLU					
CERAMIC	WU	NNX 150T CEPWU	NNX 150T CWWU				
	TG	NNX 150T CEPTG					
	PG	NNX 150T CSPG					
	VB					NNX 150T CBRVB	
	ZU	NNX 150T CEPZU	NNX 150T CAZU				
	TK	NNX 150T	NNX 150T EP	NNX 150T WW	NNX 150T WS	NNX 150T WA	NNX150T WBR

PP 66 - 67

TABLE - NNX90...

0,64 m³ G/C: 37 kg - TK: 29 kg

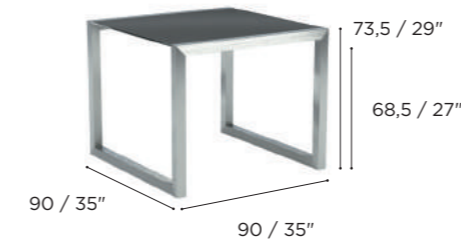

	STAINLESS STEEL BRUSHED	STAINLESS STEEL ELECTRO POLISHED
	WU	EP
GLASS	WU	NNX 90 GEPWU
	CLU	NNX 90 GEPCLU
CERAMIC	WU	NNX 90 CEPWU
	TG	NNX 90 CEPTG
	ZU	NNX 90 CEPZU
TEAK	NNX 90	NNX 90 EP

TABLE - NNX150...

1,02 m³ G/C: 53 kg - TK: 38 kg



	STAINLESS STEEL BRUSHED	STAINLESS STEEL ELECTRO POLISHED
	WU	EP
GLASS	WU	NNX 150 GEPWU
	CLU	NNX 150 GEPCLU
CERAMIC	WU	NNX 150 CEPWU
	TG	NNX 150 CEPTG
	ZU	NNX 150 CEPZU
TEAK	NNX 150	NNX 150 EP

BAR TABLE - NNX240H...

2,32 m³ G/C: 52,8 kg

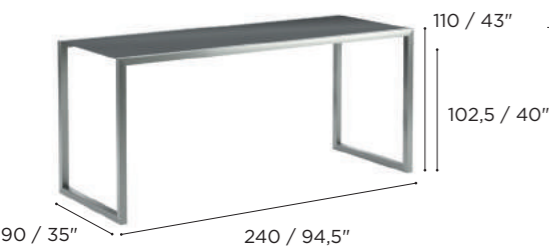

	STAINLESS STEEL BRUSHED	STAINLESS STEEL ELECTRO POLISHED	COATED STAINLESS STEEL	COATED STAINLESS STEEL	COATED STAINLESS STEEL	COATED STAINLESS STEEL	
	WU	EP	W	S	A	BR	
GLASS	WU	NNX 240H GEPWU	NNX 240H GWWU				
	CLU	NNX 240H GEPCLU					
CERAMIC	WU	NNX 240H CEPWU	NNX 240H CWWU				
	TG	NNX 240H CEPTG					
	PG	NNX 240H CSPG					
	VB					NNX 240H CBRVB	
	ZU	NNX 240H CEPZU	NNX 240H CAZU				
	TK	NNX 240H W	NNX 240H WEP	NNX 240H WW	NNX 240H WS	NNX 240H WA	NNX 240H WBR

TABLE - NNX200...

1,43 m³ G/C: 66 kg - TK: 52 kg

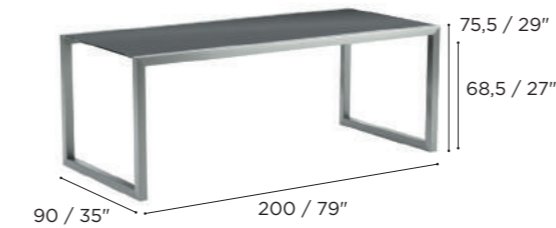

	STAINLESS STEEL BRUSHED	STAINLESS STEEL ELECTRO POLISHED	COATED ALUMINIUM	COATED ALUMINIUM	COATED ALUMINIUM	COATED ALUMINIUM	
	WU	EP	W	S	A	BR	
GLASS	WU	NNX 200 GEPWU	NNX 200 GWWU				
	CLU	NNX 200 GEPCLU					
CERAMIC	WU	NNX 200 CEPWU	NNX 200 CWWU				
	TG	NNX 200 CEPTG					
	PG	NNX 200 CSPG					
	VB					NNX 200 CBRVB	
ZU	NNX 200 CEPZU	NNX 200 CAZU					
TEAK	NNX 200 W	NNX 200 WEP	NNX 200 WW	NNX 200 WS	NNX 200 WA	NNX 200 WBR	

TABLE - NNX300...

2,25 m³ G/C: 143 kg

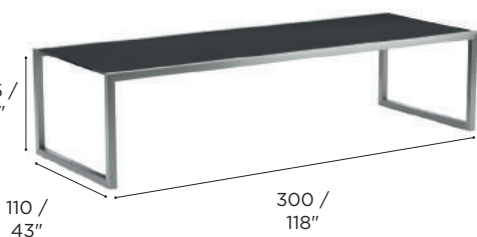

	STAINLESS STEEL BRUSHED	STAINLESS STEEL ELECTRO POLISHED	COATED STAINLESS STEEL	COATED STAINLESS STEEL	COATED STAINLESS STEEL	COATED STAINLESS STEEL
	WU	EP	W	S	A	BR
GLASS	WU	NNX 300 GWU	NNX 300 GEPWU	NNX 300 GWWU		
	CLU	NNX 300 GCLU	NNX 300 GEPCLU			
CERAMIC	WU	NNX 300 CWU	NNX 300 CEPWU	NNX 300 CWWU		
	TG	NNX 300 CTG	NNX 300 CEPTG			
	PG			NNX 300 CSPG		
	VB					NNX 300 CBRVB
	ZU	NNX 300 CZU	NNX 300 CEPZU		NNX 300 CAZU	
	TK	NNX 300 W	NNX 300 WEP	NNX 300 WW	NNX 300 WS	NNX 300 WA

PP 52, 53, 57, 62 - 63

EXTENDABLE TABLE - NNX270...

1,02 m³ TK: 80 kg

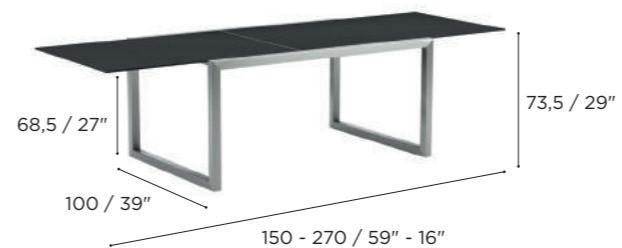

	STAINLESS STEEL BRUSHED	STAINLESS STEEL ELECTRO POLISHED	COATED STAINLESS STEEL	COATED STAINLESS STEEL	COATED STAINLESS STEEL
	WU	EP	W	S	A
GLASS	WU	NNX 270 GWU	NNX 270 GEPWU	NNX 270 GWWU	
	CLU	NNX 270 GCLU	NNX 270 GEPCLU		
CERAMIC	WU	NNX 270 CWU	NNX 270 CEPWU	NNX 270 CWWU	
	PG			NNX 270 CSPG	
	ZU	NNX 270 CZU	NNX 270 CEPZU		NNX 270 CAZU

EXTENDABLE TABLE - NNX360...

1,92 m³ G/C: 132 kg - TK: 83 kg

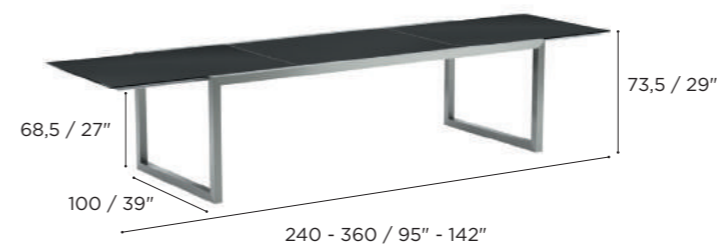

	STAINLESS STEEL BRUSHED	STAINLESS STEEL ELECTRO POLISHED	COATED STAINLESS STEEL	COATED STAINLESS STEEL	COATED STAINLESS STEEL	
	WU	EP	W	S	A	
GLASS	WU	NNX 360 GWU	NNX 360 GEPWU	NNX 360 GWWU		
	CLU	NNX 360 GCLU	NNX 360 GEPCLU			
CERAMIC	WU	NNX 360 CWU	NNX 360 CEPWU	NNX 360 CWWU		
	PG			NNX 360 CSPG		
	ZU	NNX 360 CZU	NNX 360 CEPZU		NNX 360 CAZU	
TEAK	TK	NNX 360	NNX 360 EP	NNX 360 WW	NNX 360 WS	NNX 360 WA

PP 60, 61

NINIX LOUNGE

design by Kris Van Puyvelde

STANDARD OFFER FOR NINIX LOUNGE COLLECTION (CATEGORY B FABRICS)



ALL OTHER FABRICS AVAILABLE ON REQUEST - PP 270 - 273



ONE SEATER MODULAR ELEMENT - NNXL80...

0,55 m³ 21,3 kg



	STAINLESS STEEL BRUSHED	STAINLESS STEEL ELECTRO POLISHED	COATED ALUMINIUM	COATED ALUMINIUM	COATED ALUMINIUM
		EP	W	S	A
BATYLINE WU	NNXL 80 TWU	NNXL 80 TEPWU	NNXL 80 TWWU		
BATYLINE CAU	NNXL 80 TCAU	NNXL 80 TEPCAU			
BATYLINE PG			NNXL 80 TSPG		
BATYLINE TZU	NNXL 80 TZU	NNXL 80 TEPZU		NNXL 80 TAZU	

ONE SEATER - NNXL100...

0,55 m³ 25,7 kg

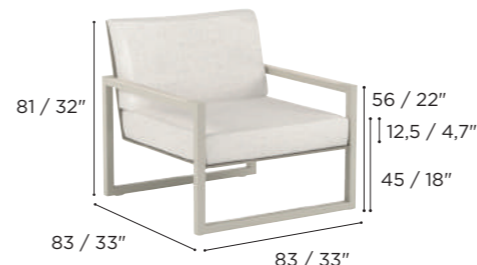

	STAINLESS STEEL BRUSHED	STAINLESS STEEL ELECTRO POLISHED	COATED ALUMINIUM	COATED ALUMINIUM	COATED ALUMINIUM	COATED ALUMINIUM
		EP	W	S	A	BR
BATYLINE WU	NNXL 100 TWU	NNXL 100 TEPWU	NNXL 100 TWWU			
BATYLINE CAU	NNXL 100 TCAU	NNXL 100 TEPCAU				
BATYLINE PG			NNXL 100 TSPG			
BATYLINE TZU	NNXL 100 TZU	NNXL 100 TEPZU		NNXL 100 TAZU		
BATYLINE BR						NNXL 100 TBRBR

OPTIONAL TEAK ARMRESTS	NNXL 100 T ARWSET

CUSHIONS FOR NNXL80 / NNXL80L / NNXL80R / NNXL100

	NORMAL BACK CUSHION
	PIL NNXL 80 ED... (2 pcs)
STANDARD	
CAT. A	
CAT. B	

	SOFT BACK CUSHION
	PIL NNXL 80 EDS... (2 pcs)
STANDARD	
CAT. A	
CAT. B	

PP 64 - 65

CORNER MODULE RIGHT - NNXL80R...

0,55 m³ 23,4 kg



	STAINLESS STEEL BRUSHED	STAINLESS STEEL ELECTRO POLISHED	COATED ALUMINIUM	COATED ALUMINIUM	COATED ALUMINIUM
		EP	W	S	A
BATYLINE WU	NNXL 80 RTWU	NNXL 80 RTEPWU	NNXL 80 RTWWU		
BATYLINE CAU	NNXL 80 RTCAU	NNXL 80 RTEPCAU			
BATYLINE PG			NNXL 80 RTSPG		
BATYLINE TZU	NNXL 80 RTZU	NNXL 80 RTEPZU		NNXL 80 RTAZU	
OPTIONAL TEAK ARMRESTS			NNXL 80 T ARWSET		

CORNER MODULE LEFT - NNXL80L...

0,55 m³ 23,4 kg

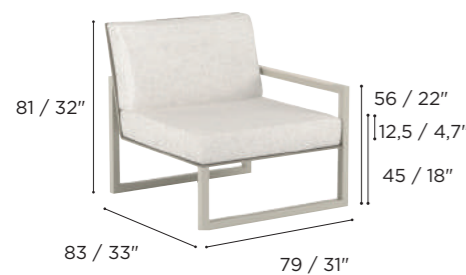

	STAINLESS STEEL BRUSHED	STAINLESS STEEL ELECTRO POLISHED	COATED ALUMINIUM	COATED ALUMINIUM	COATED ALUMINIUM
		EP	W	S	A
BATYLINE WU	NNXL 80 LTWU	NNXL 80 LTEPWU	NNXL 80 LTWWU		
BATYLINE CAU	NNXL 80 LTCAU	NNXL 80 LTEPCAU			
BATYLINE PG			NNXL 80 LTSPG		
BATYLINE TZU	NNXL 80 LTZU	NNXL 80 LTEPZU		NNXL 80 LTAZU	
OPTIONAL TEAK ARMRESTS			NNXL 80 T ARWSET		

FOOTREST - NNXL80FT...

0,17 m³ 14,9 kg



	STAINLESS STEEL BRUSHED	STAINLESS STEEL ELECTRO POLISHED	COATED ALUMINIUM	COATED ALUMINIUM	COATED ALUMINIUM	COATED ALUMINIUM
		EP	W	S	A	BR
BATYLINE WU	NNXL 80 FTWU	NNXL 80 FTEPWU	NNXL 80 FTWWU			
BATYLINE CAU	NNXL 80 FTCAU	NNXL 80 FTEPCAU				
BATYLINE PG			NNXL 80 FTSPG			
BATYLINE TZU	NNXL 80 FTZU	NNXL 80 FTEPZU		NNXL 80 FTAZU		
BATYLINE BR						NNXL 80 FTBRBR

	CUSHIONS
	PIL NNXL 80 F ED... (1 pc)
STANDARD	
CAT. A	
CAT. B	

PP 64 - 65, 66 - 67

CORNER MODULE - NNXL80C...

0,55 m³ 29,4 kg

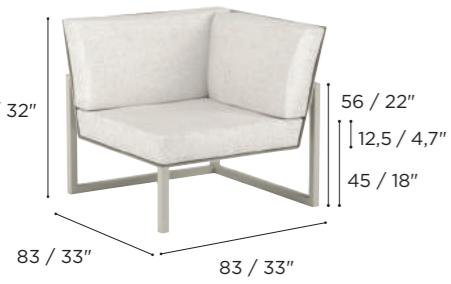

	STAINLESS STEEL BRUSHED	STAINLESS STEEL ELECTRO POLISHED	COATED ALUMINIUM	COATED ALUMINIUM	COATED ALUMINIUM	COATED ALUMINIUM
	WU	EP	W	S	A	BR
WU	NNXL 80 CTWU	NNXL 80 CTEPWU	NNXL 80 CTWWU			
CAU	NNXL 80 CTCAU	NNXL 80 CTEPCAU				
BATYLINE			NNXL 80 CTSPG			
PG						
TZU	NNXL 80 CTZU	NNXL 80 CTEPZU		NNXL 80 CTAZU		
BR						NNXL 80 CTBRBR
CUSHIONS						
	NORMAL BACK CUSHION			SOFT BACK CUSHION		
	PIL NNXL 80 C ED... (3 pcs)			PIL NNXL 80 C EDS... (3 pcs)		
STANDARD						
CAT. A						
CAT. B						

PP 66 - 67

TWO SEATER MODULE LEFT - NNXL160L...

1,04 m³ 46,8 kg



	STAINLESS STEEL BRUSHED	STAINLESS STEEL ELECTRO POLISHED	COATED ALUMINIUM	COATED ALUMINIUM	COATED ALUMINIUM	COATED ALUMINIUM
	WU	EP	W	S	A	BR
WU	NNXL 160 LTWU	NNXL 160 LTEPWU	NNXL 160 LTWWU			
CAU	NNXL 160 LTCAU	NNXL 160 LTEPCAU				
BATYLINE			NNXL 160 LTSPG			
PG						
TZU	NNXL 160 LTZU	NNXL 160 LTEPZU		NNXL 160 LTAZU		
BR						NNXL 160 LTBRBR
OPTIONAL TEAK ARMREST	NNXL 80 T ARWSET					

PP 66 - 67

TWO SEATER BENCH - NNXL160...

1,04 m³ 49 kg



	STAINLESS STEEL BRUSHED	STAINLESS STEEL ELECTRO POLISHED	COATED ALUMINIUM	COATED ALUMINIUM	COATED ALUMINIUM	COATED ALUMINIUM
	WU	EP	W	S	A	BR
WU	NNXL 160 TWU	NNXL 160 TEPWU	NNXL 160 TWWU			
CAU	NNXL 160 TCAU	NNXL 160 TEPCAU				
BATYLINE			NNXL 160 TSPG			
PG						
TZU	NNXL 160 TZU	NNXL 160 TEPZU		NNXL 160 TAZU		
BR						NNXL 160 TBRBR
OPTIONAL TEAK ARMREST	NNXL 100 T ARWSET					

TWO SEATER MODULE RIGHT - NNXL160R...

1,04 m³ 46,8 kg



	STAINLESS STEEL BRUSHED	STAINLESS STEEL ELECTRO POLISHED	COATED ALUMINIUM	COATED ALUMINIUM	COATED ALUMINIUM	COATED ALUMINIUM
	WU	EP	W	S	A	BR
WU	NNXL 160 RTWU	NNXL 160 RTEPWU	NNXL 160 RTWWU			
CAU	NNXL 160 RTCAU	NNXL 160 RTEPCAU				
BATYLINE			NNXL 160 RTSPG			
PG						
TZU	NNXL 160 RTZU	NNXL 160 RTEPZU		NNXL 160 RTAZU		
BR						NNXL 160 RTBRBR
OPTIONAL TEAK ARMREST	NNXL 80 T ARWSET					

TWO SEATER MODULE - NNXL160Z...

1,04 m³ 44,7 kg



	STAINLESS STEEL BRUSHED	STAINLESS STEEL ELECTRO POLISHED	COATED ALUMINIUM	COATED ALUMINIUM	COATED ALUMINIUM	COATED ALUMINIUM
	WU	EP	W	S	A	BR
WU	NNXL 160Z TWU	NNXL 160Z TEPWU	NNXL 160Z TWWU			
CAU	NNXL 160Z TCAU	NNXL 160Z TEPCAU				
BATYLINE			NNXL 160Z TSPG			
PG						
TZU	NNXL 160Z TZU	NNXL 160Z TEPZU		NNXL 160Z TAZU		
BR						NNXL 160Z BRBR

PP 66 - 67

CUSHIONS FOR NNXL160 / NNXL160Z / NNXL160L / NNXL160R		
	NORMAL BACK CUSHION	SOFT BACK CUSHION
	1x PIL NNXL 160 ED... (3 pcs)	1x PIL NNXL 160 EDS... (3 pcs)
STANDARD		
CAT. A		
CAT. B		
	2x PIL NNXL 80 ED... (4 pcs)	2x PIL NNXL 80 EDS... (4 pcs)
STANDARD		
CAT. A		
CAT. B		

PP 66 - 67

THREE SEATER BENCH - NNXL240...

1,54 m³ 68,1 kg



	STAINLESS STEEL BRUSHED	STAINLESS STEEL ELECTRO POLISHED	COATED ALUMINIUM	COATED ALUMINIUM	COATED ALUMINIUM	COATED ALUMINIUM
		EP	W	S	A	BR
WU	NNXL 240 TWU	NNXL 240 TEPWU	NNXL 240 TWWU			
CAL	NNXL 240 TCAU	NNXL 240 TEPCAU				
BATYLINE			NNXL 240 TSPG			
PG						
	NNXL 240 TZU	NNXL 240 TEPZU		NNXL 240 TAZU		
BR						NNXL 240 TBRBR
OPTIONAL TEAK ARMRESTS	NNXL 100 T ARWSET					

THREE SEATER MODULE LEFT - NNXL240L...

1,54 m³ 70,2 kg



	STAINLESS STEEL BRUSHED	STAINLESS STEEL ELECTRO POLISHED	COATED ALUMINIUM	COATED ALUMINIUM	COATED ALUMINIUM	COATED ALUMINIUM
		EP	W	S	A	BR
WU	NNXL 240 LTWU	NNXL 240 LTEPWU	NNXL 240 LTWWU			
CAL	NNXL 240 LTCAU	NNXL 240 LTEPCAU				
BATYLINE			NNXL 240 LTSPG			
PG						
	NNXL 240 LTZU	NNXL 240 LTEPZU		NNXL 240 LTAZU		
BR						NNXL 240 LTBRBR
OPTIONAL TEAK ARMREST	NNXL 80 T ARWSET					

THREE SEATER MODULE RIGHT - NNXL240R...

1,54 m³ 70,2 kg



	STAINLESS STEEL BRUSHED	STAINLESS STEEL ELECTRO POLISHED	COATED ALUMINIUM	COATED ALUMINIUM	COATED ALUMINIUM	COATED ALUMINIUM
		EP	W	S	A	BR
WU	NNXL 240 RTWU	NNXL 240 RTEPWU	NNXL 240 RTWWU			
CAL	NNXL 240 RTCAU	NNXL 240 RTEPCAU				
BATYLINE			NNXL 240 RTSPG			
PG						
	NNXL 240 RTZU	NNXL 240 RTEPZU		NNXL 240 RTAZU		
BR						NNXL 240 RTBRBR
OPTIONAL TEAK ARMREST	NNXL 80 T ARWSET					

CUSHIONS FOR NNXL240 / NNXL240L / NNXL240R

	NORMAL BACK CUSHION	SOFT BACK CUSHION
	1x PIL NNXL 240 ED... (4 pcs)	1x PIL NNXL 240 EDS... (4 pcs)
STANDARD	•	•
CAT. A	•	•
CAT. B	•	•
	3x PIL NNXL 80 ED... (6 pcs)	3x PIL NNXL 80 EDS... (6 pcs)
STANDARD	•	•
CAT. A	•	•
CAT. B	•	•



HARD BACK CUSHION
ref: PIL NNXL ... ED ...



SOFT BACK CUSHION
ref: PIL NNXL ... EDS ...

LOUNGE TABLE - NNXL40T...

0,10 m³ 12,8 kg

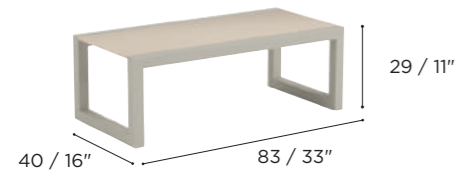

	STAINLESS STEEL BRUSHED	STAINLESS STEEL ELECTRO POLISHED	COATED ALUMINIUM	COATED ALUMINIUM	COATED ALUMINIUM	COATED ALUMINIUM
	W	EP	W	S	A	BR
GLASS	WU	NNXL 40T GWU	NNXL 40T GEPWU	NNXL 40T GWWU		
	CLU	NNXL 40T GCLU	NNXL 40T GEPCLU			
CERAMIC	WU	NNXL 40T CWU	NNXL 40T CEPWU	NNXL 40T CWWU		
	TG	NNXL 40T CTG	NNXL 40T CEPTG			
	PG			NNXL 40T CSPG		
	ZU	NNXL 40T CZU	NNXL 40T CEPZU		NNXL 40T CAZU	
	VB					NNXL 40T CBRVB
	TK	NNXL 40T W	NNXL 40T WEP	NNXL 40T WW	NNXL 40T WS	NNXL 40T WA

LOUNGE TABLE - NNXL150T...

0,63 m³ 62,3 kg

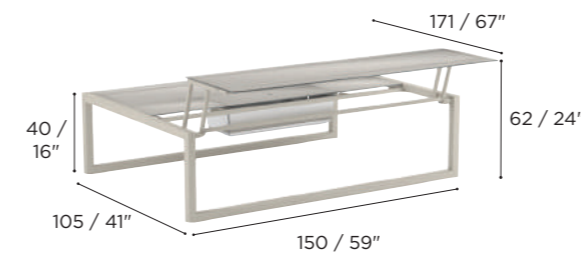

	STAINLESS STEEL BRUSHED	STAINLESS STEEL ELECTRO POLISHED	COATED STAINLESS STEEL	COATED STAINLESS STEEL	COATED STAINLESS STEEL	COATED STAINLESS STEEL
	W	EP	W	S	A	BR
GLASS	WU	NNXL 150T GWU	NNXL 150T GEPWU	NNXL 150T GWWU		
	CLU	NNXL 150T GCLU	NNXL 150T GEPCLU			
CERAMIC	WU	NNXL 150T CWU	NNXL 150T CEPWU	NNXL 150T CWWU		
	TG	NNXL 150T CTG	NNXL 150T CEPTG			
	PG			NNXL 150T CSPG		
	ZU	NNXL 150T CZU	NNXL 150T CEPZU		NNXL 150T CAZU	
	VB					NNXL 150T CBRVB
	TK					

LOUNGE TABLE - NNXL40S...

0,19 m³ 19,5 kg

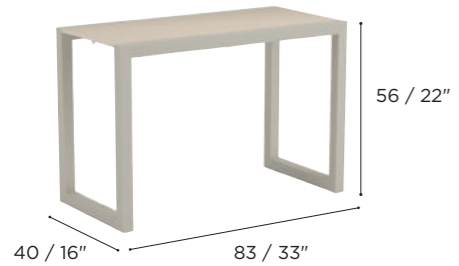

	STAINLESS STEEL BRUSHED	STAINLESS STEEL ELECTRO POLISHED	COATED ALUMINIUM	COATED ALUMINIUM	COATED ALUMINIUM	COATED ALUMINIUM
	W	EP	W	S	A	BR
GLASS	WU	NNXL 40S GWU	NNXL 40S GEPWU	NNXL 40S GWWU		
	CLU	NNXL 40S GCLU	NNXL 40S GEPCLU			
CERAMIC	WU	NNXL 40S CWU	NNXL 40S CEPWU	NNXL 40S CWWU		
	TG	NNXL 40S CTG	NNXL 40S CEPTG			
	PG			NNXL 40S CSPG		
	ZU	NNXL 40S CZU	NNXL 40S CEPZU		NNXL 40S CAZU	
	VB					NNXL 40S CBRVB
	TK	NNXL 40S W	NNXL 40S WEP	NNXL 40S WW	NNXL 40S WS	NNXL 40S WA

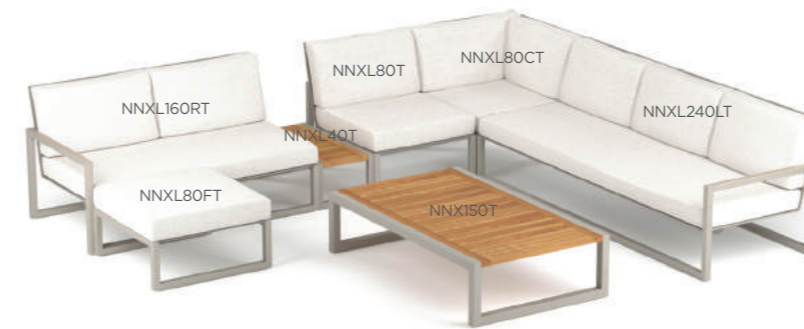

NNXL LOUNGE SET 01



NNXL SET 01

INCLUDED

- 1 x NNXL 160LT + CUSHIONS (3 pcs)
- 1 x NNXL 80CT + CUSHIONS (3 pcs)
- 1 x NNXL 240RT + CUSHIONS (4 pcs)
- 1 x NNX 150T (WS)
- 4 x PIL 40

* = PRICE FOR COATED ALUMINIUM FRAME AND STANDARD CUSHIONS (CAT. B)

NNXL LOUNGE SET 02



NNXL SET 02

INCLUDED

- 1 x NNXL 240T + CUSHIONS (4 pcs)
- 2 x NNXL 100T + CUSHIONS (2 pcs)
- 1 x NNX 150T CSPG
- 4 x PIL 40

* = PRICE FOR COATED ALUMINIUM FRAME AND STANDARD CUSHIONS (CAT. B)

O-ZON

design by Kris Van Puyvelde

CHAIR - OZN47T...

0,26 m³ (4) 5,4 kg

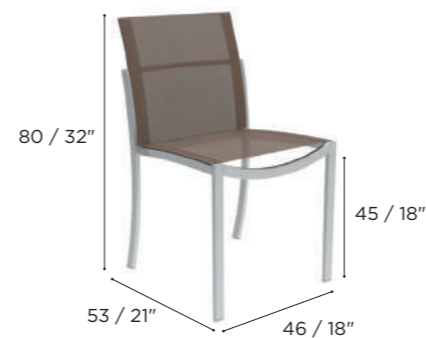

	STAINLESS STEEL BRUSHED	STAINLESS STEEL ELECTRO POLISHED	COATED ALUMINIUM	COATED ALUMINIUM	COATED ALUMINIUM
		EP	WR	S	A
	OZN 47 TWU	OZN 47 TEPWU	OZN 47 TWWU		
BATYLINE	OZN 47 TCAU	OZN 47 TEPCAU			
			OZN 47 TSPG		
	OZN 47 TZU	OZN 47 TEPZU			OZN 47 TAZU
CUSHIONS					
PIL OZN 47 T ...					
CAT. A					
CAT. B					
PP 74, 75					

ARMCHAIR - OZN55T...

0,32 m³ (4) 7 kg

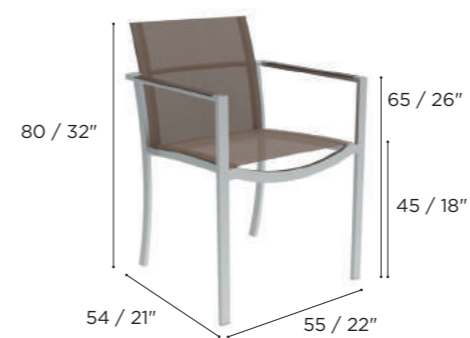

	STAINLESS STEEL BRUSHED	STAINLESS STEEL ELECTRO POLISHED	COATED ALUMINIUM	COATED ALUMINIUM	COATED ALUMINIUM
		EP	WR	S	A
	OZN 55 TWU	OZN 55 TEPWU	OZN 55 TWWU		
BATYLINE	OZN 55 TCAU	OZN 55 TEPCAU			
			OZN 55 TSPG		
	OZN 55 TZU	OZN 55 TEPZU			OZN 55 TAZU
OPTIONAL TEAK ARMRESTS					
OZN 55 T ARWSET					
CUSHIONS					
PIL OZN 55 T ...					
CAT. A					
CAT. B					
PP 68, 70, 71, 72, 73					

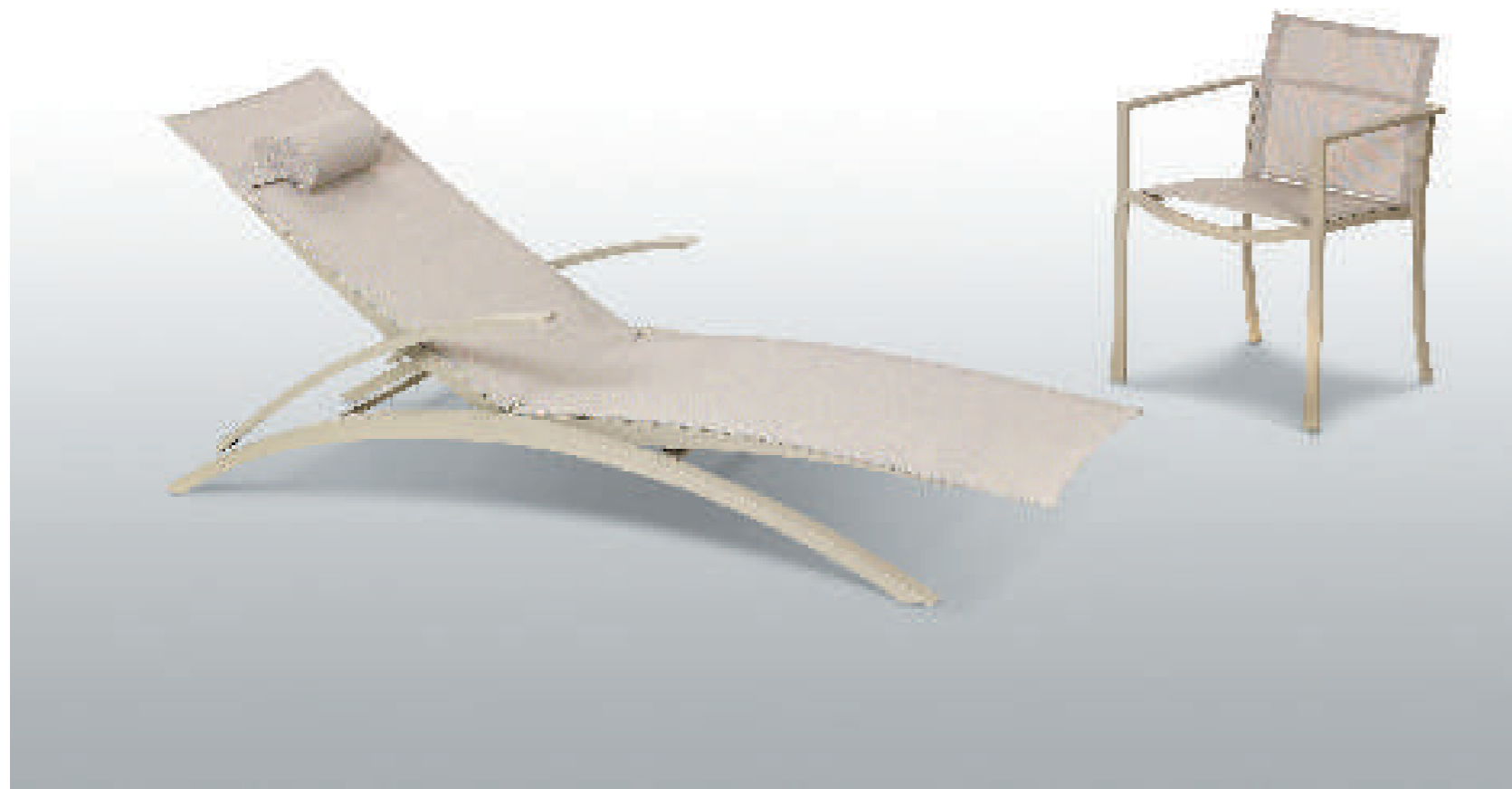

BAR CHAIR - OZN43T...

0,26 m³ 8,1 kg

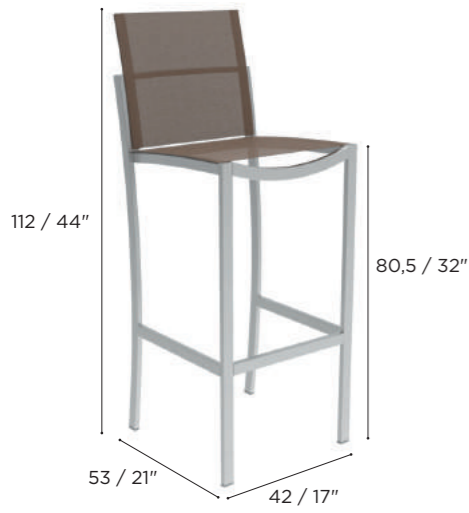

	STAINLESS STEEL BRUSHED	STAINLESS STEEL ELECTRO POLISHED	COATED ALUMINIUM	COATED ALUMINIUM	COATED ALUMINIUM
BATYLINE	WU	EP	WR	S	A
	OZN 43 TWU	OZN 43 TEPWU	OZN 43 TWWU		
	CAU	OZN 43 TCAU	OZN 43 TPCAU		
	PG		OZN 43 TSPG		
	ZU	OZN 43 TZU	OZN 43 TEPZU	OZN 43 TAZU	
CUSHIONS					
PIL OZN 43 T ...					
CAT. A					
CAT. B					

LOUNGER - OZN195T...

0,45 m³ (2) 28 kg INCL. HEADCUSHION

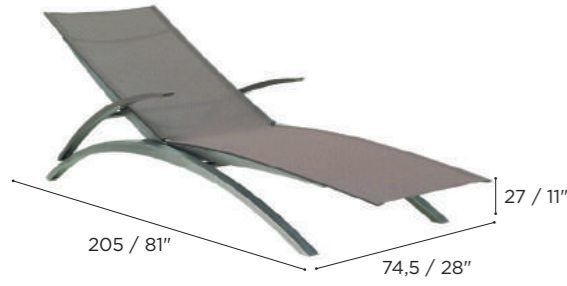

	STAINLESS STEEL BRUSHED	STAINLESS STEEL ELECTRO POLISHED	COATED ALUMINIUM
BATYLINE	WU	EP	S
	OZN 195 TWU	OZN 195 TEPWU	
	CAU	OZN 195 TCAU	OZN 195 TPCAU
	PG		OZN 195 TSPG
	ZU	OZN 195 TZU	OZN 195 TEPZU
OPTIONAL TEAK ARMRESTS	OZN 195 T ARWSET		
CUSHIONS			
PIL OZN 195 T ...			
CAT. A			
CAT. B			

PP 68 - 69

SIDE TABLE - OZN50...

0,10 m³ 10,4 kg

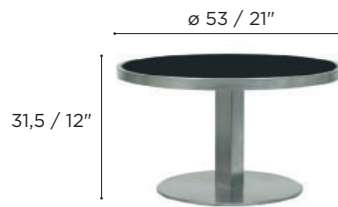

	STAINLESS STEEL BRUSHED	STAINLESS STEEL ELECTRO POLISHED	COATED ALUMINIUM
GLASS	WU	EP	S
	OZN 50 GWU	OZN 50 GEPWU	
	CLU	OZN 50 GCLU	OZN 50 GEPCLU
	WUM	OZN 50 CWUM	OZN 50 CEPWUM
	TG	OZN 50 CTG	OZN 50 CEPTG
CERAMIC	PG		OZN 50 CSPG
	ZUM	OZN 50 CZUM	OZN 50 CEPZUM

PP 68 - 69

ROUND TABLE - OZN130...

0,29 m³ 31,2 kg



	STAINLESS STEEL BRUSHED	STAINLESS STEEL ELECTRO POLISHED	COATED ALUMINIUM
GLASS	WU	EP	S
	OZN 130 GWU	OZN 130 GEPWU	
	CLU	OZN 130 GCLU	OZN 130 GEPCLU
	WUM	OZN 130 CWUM	OZN 130 CEPWUM
CERAMIC	TG	OZN 130 CTG	OZN 130 CEPTG
	PG		OZN 130 CSPG
	ZUM	OZN 130 CZUM	OZN 130 CEPZUM

PP 68, 74, 75

ROUND TABLE - OZN160...

0,31 m³ 78 kg



	STAINLESS STEEL BRUSHED	STAINLESS STEEL ELECTRO POLISHED	COATED STAINLESS STEEL	COATED STAINLESS STEEL	COATED STAINLESS STEEL
GLASS	WU	EP	W	S	A
	OZN 160 GWU	OZN 160 GEPWU			
	CLU	OZN 160 GCLU	OZN 160 GEPCLU		
	WUM	OZN 160 CWUM	OZN 160 CEPWUM	OZN 160 CWWUM	
	TG	OZN 160 CTG	OZN 160 CEPTG		
CERAMIC	PG			OZN 160 CSPG	
	ZUM	OZN 160 CZUM	OZN 160 CEPZUM	OZN 160 CAZUM	

ROUND TABLE WITH S/S CENTER - OZN160...

0,31 m³ 77 kg

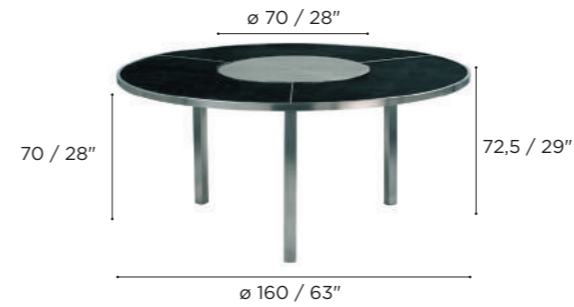

	STAINLESS STEEL BRUSHED	STAINLESS STEEL ELECTRO POLISHED	COATED STAINLESS STEEL	COATED STAINLESS STEEL S/S EP CENTER	COATED STAINLESS STEEL	COATED STAINLESS STEEL S/S EP CENTER	COATED STAINLESS STEEL	COATED STAINLESS STEEL S/S EP CENTER	
GLASS	WU	EP	W	W	S	S	A	A	
	OZN 160 GSWU	OZN 160 GSEPWU							
	CLU	OZN 160 GSCLU	OZN 160 GSEPCLU						
	WUM	OZN 160 CSWUM	OZN 160 CSEPWUM	OZN 160 CSWWUM	OZN 160 CSEPWUM				
	TG	OZN 160 CSTG	OZN 160 CSEPTG						
CERAMIC	PG				OZN 160 CSSPG	OZN 160 CSEPSPG			
	ZUM	OZN 160 CSZUM	OZN 160 CSEPZUM				OZN 160 CSAZUM	OZN 160 CSEPAZUM	
TEAK	TK	OZN 160 WS	OZN 160 WSEP	OZN 160 WSW	OZN 160 WSEPW	OZN 160 WSS	OZN 160 WSEPS	OZN 160 WSA	OZN 160 WSEPA

PP 71

LEG SET FOR HIGH TABLE - OZN130/160...

0,1 m³ 13,5 kg



ROUND TABLE - OZN185...

0,35 m³ 100 kg



ROUND TABLE WITH S/S CENTER - OZN185...

0,35 m³ 108 kg

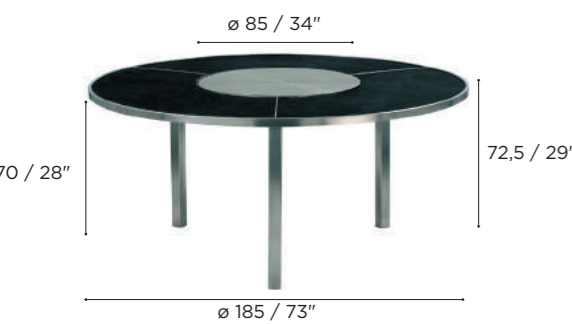

	STAINLESS STEEL BRUSHED	STAINLESS STEEL ELECTRO POLISHED	COATED ALUMINIUM
	OZN 130 HLS	OZN 130 HLSEP	OZN 130 HLSS
	OZN 160 HLS	OZN 160 HLSEP	OZN 160 HLSS

	STAINLESS STEEL BRUSHED	STAINLESS STEEL ELECTRO POLISHED	COATED STAINLESS STEEL
GLASS	OZN 185 GWU	OZN 185 GEPWU	
	OZN 185 GCLU	OZN 185 GEPCLU	
	OZN 185 CWUM	OZN 185 CEPWUM	
CERAMIC	OZN 185 CTG	OZN 185 CEPTG	
			OZN 185 CSPG
	OZN 185 CZUM	OZN 185 CEPZUM	

	STAINLESS STEEL BRUSHED	STAINLESS STEEL ELECTRO POLISHED	COATED STAINLESS STEEL	COATED STAINLESS STEEL S/S EP CENTER
GLASS	OZN 185 GSWU	OZN 185 GSEPWU		
	OZN 185 GSCLU	OZN 185 GSEPCLU		
	OZN 185 CSWUM	OZN 185 CSEPWUM		
CERAMIC	OZN 185 CSTG	OZN 185 CSEPTG		
			OZN 185 CSSPG	OZN 185 CSEPSPG
	OZN 185 CSZUM	OZN 185 CSEPZUM		
TEAK	OZN 185 WS	OZN 185 WSEP	OZN 185 WSS	OZN 185 WSEPS

PP 70

OVAL TABLE - OZN240...

0,58 m³ ALU: 95 kg

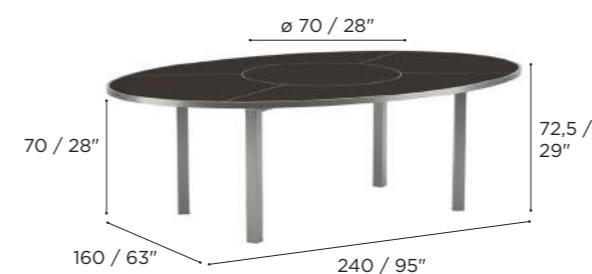

OVAL TABLE WITH S/S CENTER - OZN240...

0,58 m³ ALU: 90 kg

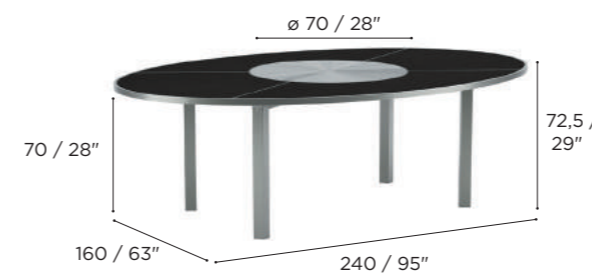

	STAINLESS STEEL BRUSHED	STAINLESS STEEL ELECTRO POLISHED	COATED STAINLESS STEEL	COATED STAINLESS STEEL	COATED STAINLESS STEEL
WU	OZN 240 CWUM	OZN 240 CEPWUM	OZN 240 CWWUM		
	OZN 240 CTG	OZN 240 CEPTG			
TG					
				OZN 240 CSPG	
PG					
	OZN 240 CZUM	OZN 240 CEPZUM			OZN 240 CAZUM
ZUM					
TEAK			OZN 240 WCWUM	OZN 240 WCSPG	OZN 240 WCAZUM
TK					

	STAINLESS STEEL BRUSHED	STAINLESS STEEL ELECTRO POLISHED	COATED STAINLESS STEEL	COATED STAINLESS STEEL S/S EP CENTER	COATED STAINLESS STEEL	COATED STAINLESS STEEL S/S EP CENTER	COATED STAINLESS STEEL	COATED STAINLESS STEEL S/S EP CENTER
WU	OZN 240 CSWUM	OZN 240 CSEPWUM	OZN 240 CSWWUM	OZN 240 CSEPWUM				
	OZN 240 CSTG	OZN 240 CSEPTG						
TG								
					OZN 240 CSSPG	OZN 240 CSEPSPG		
PG								
	OZN 240 CSZUM	OZN 240 CSEPZUM					OZN 240 CSAZUM	OZN 240 CSEPAZUM
ZUM								
TEAK	OZN 240 WS	OZN 240 WSEP	OZN 240 WSW	OZN 240 WSEPW	OZN 240 WSS	OZN 240 WSEPS	OZN 240 WSA	OZN 240 WSEPA
TK								

PP 72, 73

QT

design by Kris Van Puyvelde

CHAIR - QT55...

0,31 m³ (4) 8,6 kg

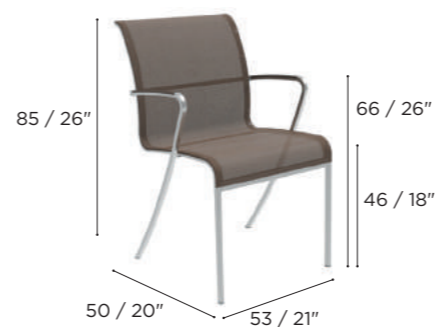

RELAX CHAIR - QT195...

0,44 m³ (2) 18,8 kg INCL. HEADCUSHION



SIDE TABLE - QT50...

0,1 m³ 8 kg

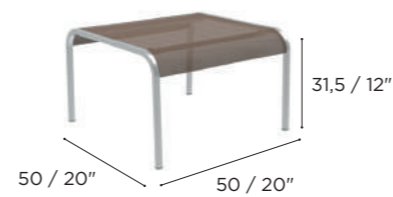

	STAINLESS STEEL BRUSHED	STAINLESS STEEL ELECTRO POLISHED	COATED STAINLESS STEEL	COATED STAINLESS STEEL	COATED STAINLESS STEEL
		EP	WR	S	A
WU	QT 55 TWU	QT 55 TEPWU	QT 55 TWRWU		
BATYLINE CAU	QT 55 TCAU	QT 55 TEPCAU			
PG				QT 55 TSPG	
TZ	QT 55 TZU	QT 55 TEPZU			QT 55 TAZU
OPTIONAL TEAK ARMRESTS	QT 55 TARWSET				

PP 78, 79, 80, 81, 82, 83

	STAINLESS STEEL BRUSHED	STAINLESS STEEL ELECTRO POLISHED	COATED STAINLESS STEEL	COATED STAINLESS STEEL	COATED STAINLESS STEEL
		EP	WR	S	A
WU	QT 195 TWU	QT 195 TEPWU	QT 195 TWRWU		
BATYLINE CAU	QT 195 TCAU	QT 195 TEPCAU			
PG				QT 195 TSPG	
TZ	QT 195 TZU	QT 195 TEPZU			QT 195 TAZU
OPTIONAL TEAK ARMRESTS	QT 195 T ARWSET				

PP 76 - 77

	STAINLESS STEEL BRUSHED	STAINLESS STEEL ELECTRO POLISHED	COATED STAINLESS STEEL	COATED STAINLESS STEEL	COATED STAINLESS STEEL
		EP	WR	S	A
ALUMINUM WR	QT 50 AWR	QT 50 AEPWR	QT 50 AWRWR		
S	QT 50 AS	QT 50 AEPS		QT 50 ASS	
A	QT 50 AA	QT 50 AEPA			QT 50 AAA

TABOELA

design by Kris Van Puyvelde



SIDE TABLE - TBL50...

0,11 m³ 11,3 kg

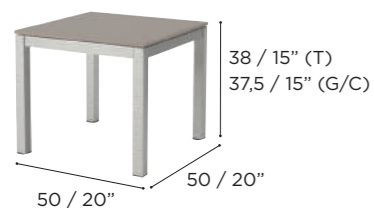

	STAINLESS STEEL BRUSHED	STAINLESS STEEL ELECTRO POLISHED	COATED ALUMINIUM	COATED ALUMINIUM	COATED ALUMINIUM	
		EP	WR	S	A	
GLASS	WU	TBL 50 GWU	TBL 50 GEPWU	TBL 50 GWWU		
	CLU	TBL 50 GCLU	TBL 50 GEPCLU			
	PG	TBL 50 GSPG				
	ZU	TBL 50 GZU	TBL 50 GEPZU	TBL 50 GAZU		
CERAMIC	WU	TBL 50 CWU	TBL 50 CEPWU	TBL 50 CWWU		
	TG	TBL 50 CTG	TBL 50 CEPTG			
	PG	TBL 50 CPG	TBL 50 CEPPG	TBL 50 CSPG		
	ZU	TBL 50 CZU	TBL 50 CEPZU	TBL 50 CAZU		
	TK	TBL 50 W	TBL 50 WEP	TBL 50 WW	TBL 50 WS	TBL 50 WA

FOLDABLE TABLE - TBL80C...

0,1 m³ G/C: 32 kg - W: 22 kg

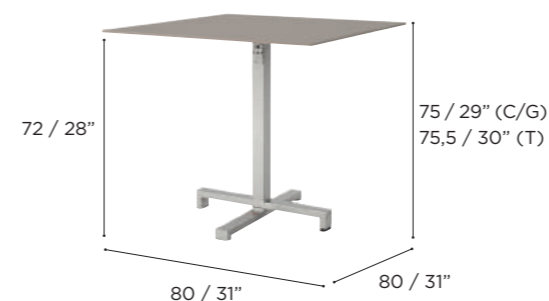

	STAINLESS STEEL BRUSHED	STAINLESS STEEL ELECTRO POLISHED	
		EP	
GLASS	WU	TBL 80C GWU	TBL 80C GEPWU
	CLU	TBL 80C GCLU	TBL 80C GEPCLU
	ZU	TBL 80C GZU	TBL 80C GEPZU
CERAMIC	WU	TBL 80C CWU	TBL 80C CEPWU
	TG	TBL 80C CTG	TBL 80C CEPTG
	PG	TBL 80C CPG	TBL 80C CEPPG
	ZU	TBL 80C CZU	TBL 80C CEPZU
	TK	TBL 80C W	TBL 80C WEP



LOW TABLE - TBL80T...

0,10 m³ G/C: 26 kg - W: 16 kg

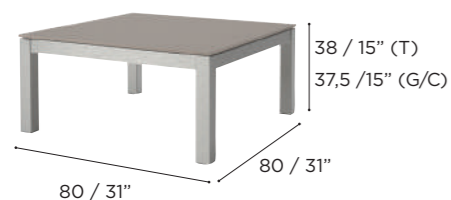

	STAINLESS STEEL BRUSHED	STAINLESS STEEL ELECTRO POLISHED	COATED ALUMINIUM	COATED ALUMINIUM	COATED ALUMINIUM	
		EP	WR	S	A	
GLASS	WU	TBL 80T GWU	TBL 80T GEPWU	TBL 80T GWWU		
	CLU	TBL 80T GCLU	TBL 80T GEPCLU			
	PG	TBL 80T GSPG				
	ZU	TBL 80T GZU	TBL 80T GEPZU	TBL 80T GAZU		
CERAMIC	WU	TBL 80T CWU	TBL 80T CEPWU	TBL 80T CWWU		
	TG	TBL 80T CTG	TBL 80T CEPTG			
	PG	TBL 80T CPG	TBL 80T CEPPG	TBL 80T CSPG		
	ZU	TBL 80T CZU	TBL 80T CEPZU	TBL 80T CAZU		
	TK	TBL 80T W	TBL 80T WEP	TBL 80T WW	TBL 80T WS	TBL 80T WA

TABLE - TBL80...

0,10 m³ G/C: 32 kg - W: 22 kg

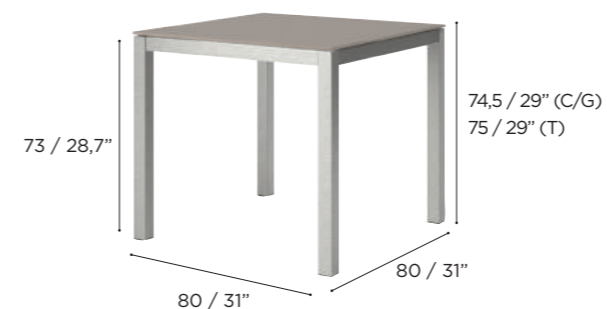

	STAINLESS STEEL BRUSHED	STAINLESS STEEL ELECTRO POLISHED	COATED ALUMINIUM	COATED ALUMINIUM	COATED ALUMINIUM	
		EP	WR	S	A	
GLASS	WU	TBL 80 GWU	TBL 80 GEPWU	TBL 80 GWWU		
	CLU	TBL 80 GCLU	TBL 80 GEPCLU			
	PG	TBL 80 GSPG				
	ZU	TBL 80 GZU	TBL 80 GEPZU	TBL 80 GAZU		
CERAMIC	WU	TBL 80 CWU	TBL 80 CEPWU	TBL 80 CWWU		
	TG	TBL 80 CTG	TBL 80 CEPTG			
	PG	TBL 80 CPG	TBL 80 CEPPG	TBL 80 CSPG		
	ZU	TBL 80 CZU	TBL 80 CEPZU	TBL 80 CAZU		
	TK	TBL 80 W	TBL 80 WEP	TBL 80 WW	TBL 80 WS	TBL 80 WA

TABLE - TBL100...

0,10 m³ 44 kg

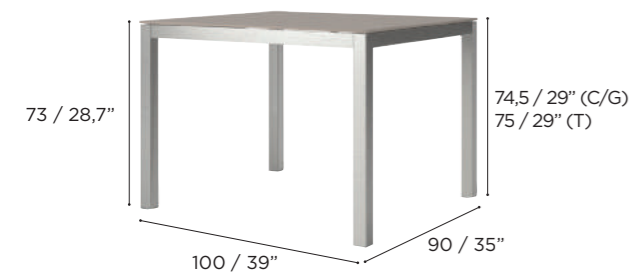

	STAINLESS STEEL BRUSHED	STAINLESS STEEL ELECTRO POLISHED	COATED ALUMINIUM	COATED ALUMINIUM	COATED ALUMINIUM	
		EP	WR	S	A	
GLASS	WU	TBL 100 GWU	TBL 100 GEPWU	TBL 100 GWWU		
	CLU	TBL 100 GCLU	TBL 100 GEPCLU			
	PG			TBL 100 GSPG		
	ZU	TBL 100 GZU	TBL 100 GEPZU		TBL 100 GAZU	
CERAMIC	WU	TBL 100 CWU	TBL 100 CEPWU	TBL 100 CWWU		
	TG	TBL 100 CTG	TBL 100 CEPTG			
	PG	TBL 100 CPG	TBL 100 CEPPG	TBL 100 CSPG		
	ZU	TBL 100 CZU	TBL 100 CEPZU		TBL 100 CAZU	
TEAK	TK	TBL 100 W	TBL 100 WEP	TBL 100 WW	TBL 100 WS	TBL 100 WA

TABLE - TBL150...

0,20 m³ 51,7 kg



	STAINLESS STEEL BRUSHED	STAINLESS STEEL ELECTRO POLISHED	COATED ALUMINIUM	COATED ALUMINIUM	COATED ALUMINIUM	
		EP	WR	S	A	
GLASS	WU	TBL 150 GWU	TBL 150 GEPWU	TBL 150 GWWU		
	CLU	TBL 150 GCLU	TBL 150 GEPCLU			
	PG			TBL 150 GSPG		
	ZU	TBL 150 GZU	TBL 150 GEPZU		TBL 150 GAZU	
CERAMIC	WU	TBL 150 CWU	TBL 150 CEPWU	TBL 150 CWWU		
	TG	TBL 150 CTG	TBL 150 CEPTG			
	PG	TBL 150 CPG	TBL 150 CEPPG	TBL 150 CSPG		
	ZU	TBL 150 CZU	TBL 150 CEPZU		TBL 150 CAZU	
TEAK	TK	TBL 150 W	TBL 150 WEP	TBL 150 WW	TBL 150 WS	TBL 150 WA

TABLE - TBL140...

0,24 m³ G/C: 62 kg - W: 40 kg



	STAINLESS STEEL BRUSHED	STAINLESS STEEL ELECTRO POLISHED	COATED ALUMINIUM	COATED ALUMINIUM	COATED ALUMINIUM	
		EP	WR	S	A	
GLASS	WU	TBL 140 GWU	TBL 140 GEPWU	TBL 140 GWWU		
	CLU	TBL 140 GCLU	TBL 140 GEPCLU			
	PG			TBL 140 GSPG		
	ZU	TBL 140 GZU	TBL 140 GEPZU		TBL 140 GAZU	
CERAMIC	WU	TBL 140 CWU	TBL 140 CEPWU	TBL 140 CWWU		
	TG	TBL 140 CTG	TBL 140 CEPTG			
	PG	TBL 140 CPG	TBL 140 CEPPG	TBL 140 CSPG		
	ZU	TBL 140 CZU	TBL 140 CEPZU		TBL 140 CAZU	
TEAK	TK	TBL 140 W	TBL 140 WEP	TBL 140 WW	TBL 140 WS	TBL 140 WA

TABLE - TBL180...

0,24 m³ 62 kg

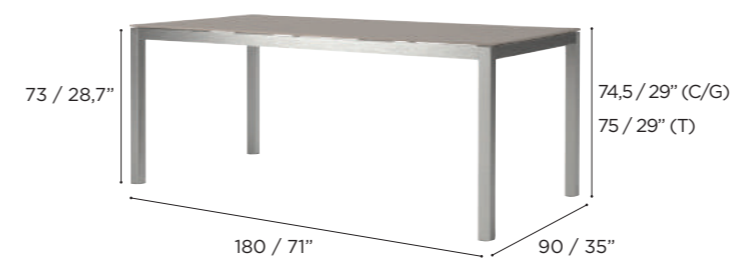

	STAINLESS STEEL BRUSHED	STAINLESS STEEL ELECTRO POLISHED	COATED ALUMINIUM	COATED ALUMINIUM	COATED ALUMINIUM	
		EP	WR	S	A	
GLASS	WU	TBL 180 GWU	TBL 180 GEPWU	TBL 180 GWWU		
	CLU	TBL 180 GCLU	TBL 180 GEPCLU			
	PG			TBL 180 GSPG		
	ZU	TBL 180 GZU	TBL 180 GEPZU		TBL 180 GAZU	
CERAMIC	WU	TBL 180 CWU	TBL 180 CEPWU	TBL 180 CWWU		
	TG	TBL 180 CTG	TBL 180 CEPTG			
	PG	TBL 180 CPG	TBL 180 CEPPG	TBL 180 CSPG		
	ZU	TBL 180 CZU	TBL 180 CEPZU		TBL 180 CAZU	
TEAK	TK	TBL 180 W	TBL 180 WEP	TBL 180 WW	TBL 180 WS	TBL 180 WA

TABLE - TBL210...

0,28 m³ 73,5 kg

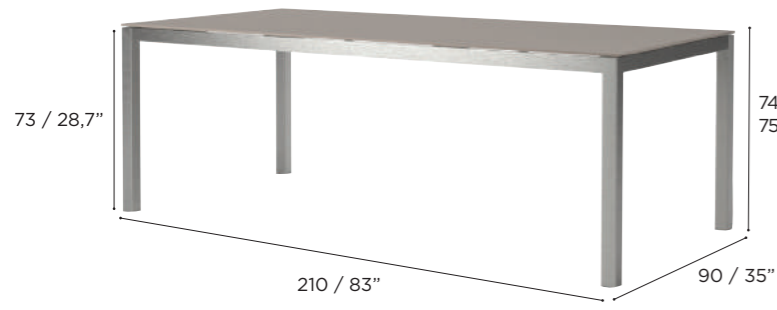

	STAINLESS STEEL BRUSHED	STAINLESS STEEL ELECTRO POLISHED	COATED STAINLESS STEEL	COATED STAINLESS STEEL	COATED STAINLESS STEEL	
	WR	S	A			
GLASS	WU	TBL 210 GWU	TBL 210 GEPWU	TBL 210 GWWU		
	CLU	TBL 210 GCLU	TBL 210 GEPCLU			
	PG			TBL 210 GSPG		
	ZU	TBL 210 GZU	TBL 210 GEPZU		TBL 210 GAZU	
CERAMIC	WU	TBL 210 CWU	TBL 210 CEPWU	TBL 210 CWWU		
	TG	TBL 210 CTG	TBL 210 CEPTG			
	PG	TBL 210 CPG	TBL 210 CEPPG	TBL 210 CSPG		
	ZU	TBL 210 CZU	TBL 210 CEPZU		TBL 210 CAZU	
TEAK	TK	TBL 210 W	TBL 210 WEP	TBL 210 WW	TBL 210 WS	TBL 210 WA

PP 80, 82, 83

TABLE - TBL240...

0,35 m³ 84 kg

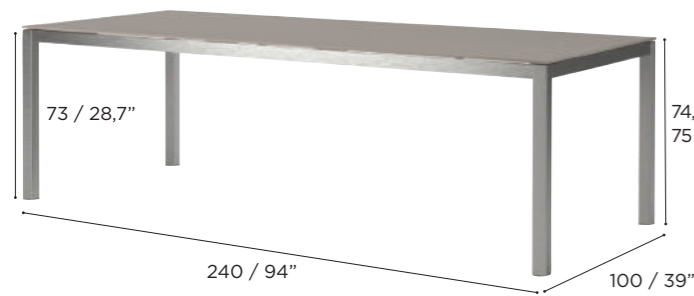

	STAINLESS STEEL BRUSHED	STAINLESS STEEL ELECTRO POLISHED	COATED STAINLESS STEEL	COATED STAINLESS STEEL	COATED STAINLESS STEEL	
	WR	S	A			
GLASS	WU	TBL 240 GWU	TBL 240 GEPWU	TBL 240 GWWU		
	CLU	TBL 240 GCLU	TBL 240 GEPCLU			
	PG			TBL 240 GSPG		
	ZU	TBL 240 GZU	TBL 240 GEPZU		TBL 240 GAZU	
CERAMIC	WU	TBL 240 CWU	TBL 240 CEPWU	TBL 240 CWWU		
	TG	TBL 240 CTG	TBL 240 CEPTG			
	PG	TBL 240 CPG	TBL 240 CEPPG	TBL 240 CSPG		
	ZU	TBL 240 CZU	TBL 240 CEPZU		TBL 240 CAZU	
TEAK	TK	TBL 240 W	TBL 240 WEP	TBL 240 WW	TBL 240 WS	TBL 240 WA

EXTENDABLE TABLE - TBL270E...

1,13 m³ 90 kg



	STAINLESS STEEL BRUSHED	STAINLESS STEEL ELECTRO POLISHED	COATED STAINLESS STEEL	COATED STAINLESS STEEL	COATED STAINLESS STEEL
	WR	S	A		
GLASS	WU	TBL 270E GWU	TBL 270E GEPWU	TBL 270E GWWU	
	CLU	TBL 270E GCLU	TBL 270E GEPCLU		
	PG			TBL 270E GSPG	
	ZU	TBL 270E GZU	TBL 270E GEPZU		TBL 270E GAZU
CERAMIC	WU	TBL 270E CWU	TBL 270E CEPWU	TBL 270E CWWU	
	TG	TBL 270E CTG	TBL 270E CEPTG		
	PG	TBL 270E CPG	TBL 270E CEPPG	TBL 270E CSPG	
	ZU	TBL 270E CZU	TBL 270E CEPZU		TBL 270E CAZU

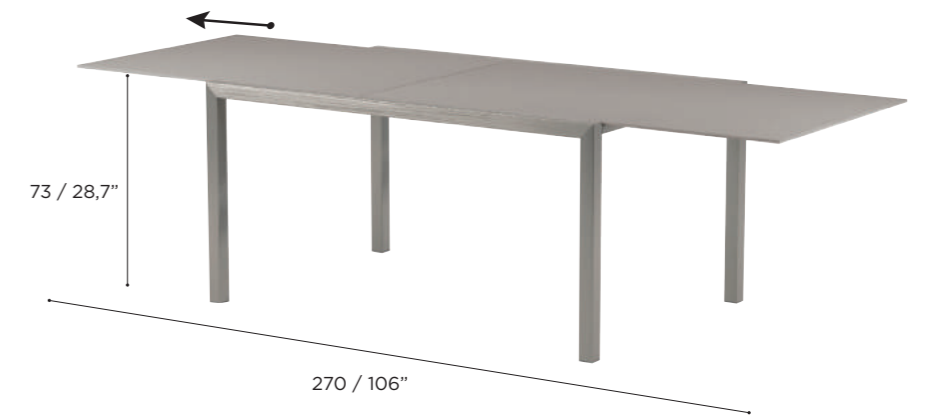
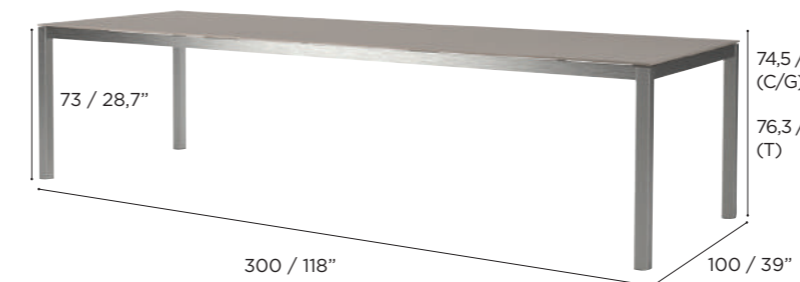

TABLE - TBL300...

0,35 m³ 124 kg



	STAINLESS STEEL BRUSHED	STAINLESS STEEL ELECTRO POLISHED	COATED STAINLESS STEEL	COATED STAINLESS STEEL	COATED STAINLESS STEEL	
	WR	S	A			
GLASS	WU	TBL 300 GWU	TBL 300 GEPWU	TBL 300 GWWU		
	CLU	TBL 300 GCLU	TBL 300 GEPCLU			
	PG			TBL 300 GSPG		
	ZU	TBL 300 GZU	TBL 300 GEPZU		TBL 300 GAZU	
CERAMIC	WU	TBL 300 CWU	TBL 300 CEPWU	TBL 300 CWWU		
	TG	TBL 300 CTG	TBL 300 CEPTG			
	PG	TBL 300 CPG	TBL 300 CEPPG	TBL 300 CSPG		
	ZU	TBL 300 CZU	TBL 300 CEPZU		TBL 300 CAZU	
TEAK	TK	TBL 300 W	TBL 300 WEP	TBL 300 WW	TBL 300 WS	TBL 300 WA

EXTENDABLE TABLE - TBL340...

1,65 m³ G/C: 11 kg - W: 73 kg

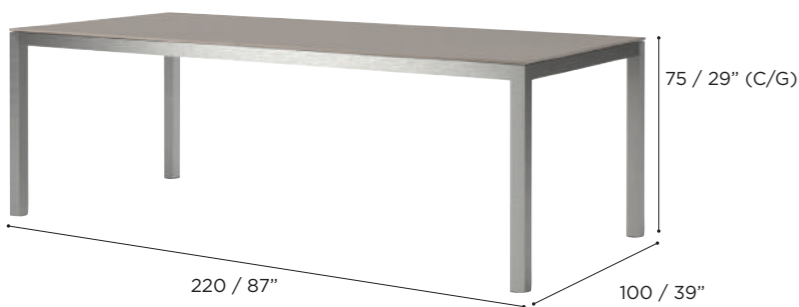

	STAINLESS STEEL BRUSHED	STAINLESS STEEL ELECTRO POLISHED	COATED STAINLESS STEEL	COATED STAINLESS STEEL	COATED STAINLESS STEEL	
	EP	WR	S	A		
CERAMIC	WU	TBL 340 CWU	TBL 340 CEPWU	TBL 340 CWWU		
	PG	TBL 340 CPG	TBL 340 CEPPG	TBL 340 CSPG		
	ZU	TBL 340 CZU	TBL 340 CEPZU	TBL 340 CAZU		
TEAK	TK	TBL 340 W	TBL 340 WEP	TBL 340 WW	TBL 340 WS	TBL 340 WA

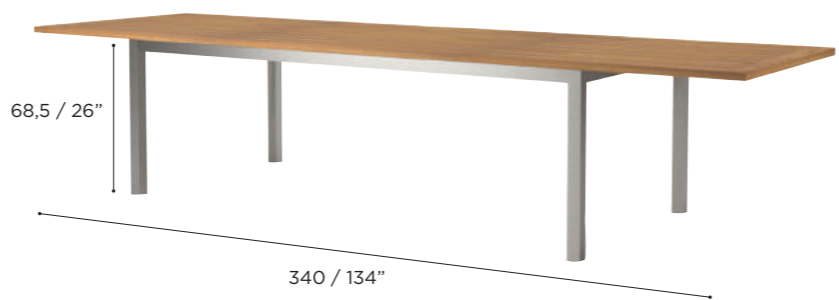
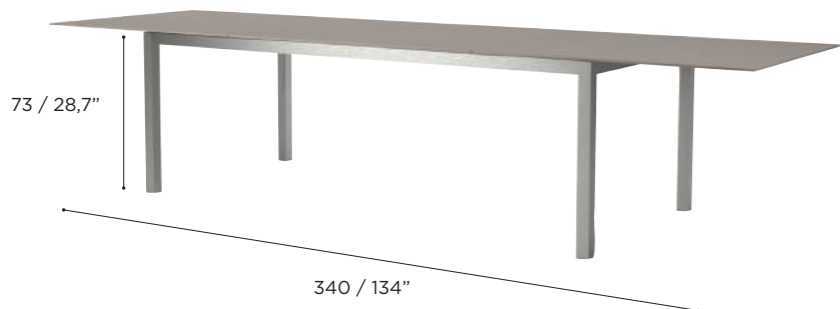

BAR TABLE - TBL80H...

0,10 m³ G/C: 36 kg - W: 26 kg

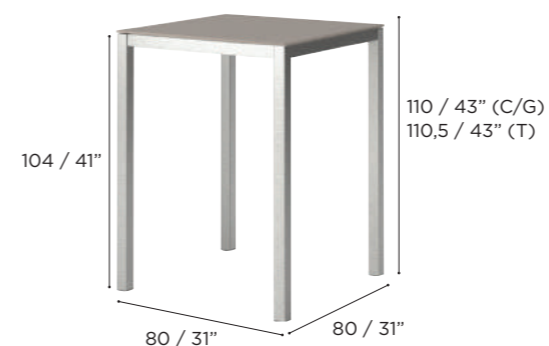

BAR TABLE - TBL200H...

0,35 m³ 84 kg

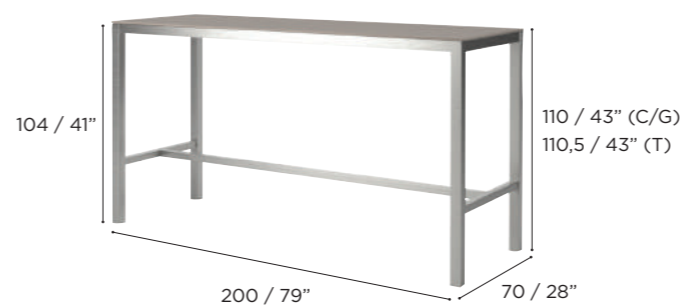

	STAINLESS STEEL BRUSHED	STAINLESS STEEL ELECTRO POLISHED	COATED STAINLESS STEEL	COATED STAINLESS STEEL	COATED STAINLESS STEEL
	EP	WR	S	A	
GLASS	WU	TBL 80H GWU	TBL 80H GEPWU	TBL 80H GWWU	
	CLU	TBL 80H GCLU	TBL 80H GEPCLU		
	PG			TBL 80H GSPG	
CERAMIC	ZU	TBL 80H GZU	TBL 80H GEPZU	TBL 80H GAZU	
	WU	TBL 80H CWU	TBL 80H CEPWU	TBL 80H CWWU	
	TG	TBL 80H CTG	TBL 80H CEPTG		
TEAK	PG	TBL 80H CPG	TBL 80H CEPPG	TBL 80H CSPG	
	ZU	TBL 80H CZU	TBL 80H CEPZU	TBL 80H CAZU	
	TK	TBL 80H W	TBL 80H WEP	TBL 80H WW	TBL 80H WS

	STAINLESS STEEL BRUSHED	STAINLESS STEEL ELECTRO POLISHED	COATED STAINLESS STEEL	COATED STAINLESS STEEL	COATED STAINLESS STEEL
	EP	WR	S	A	
GLASS	WU	TBL 200H GWU	TBL 200H GEPWU	TBL 200H GWWU	
	CLU	TBL 200H GCLU	TBL 200H GEPCLU		
	PG			TBL 200H GSPG	
CERAMIC	ZU	TBL 200H GZU	TBL 200H GEPZU	TBL 200H GAZU	
	WU	TBL 200H CWU	TBL 200H CEPWU	TBL 200H CWWU	
	TG	TBL 200H CTG	TBL 200H CEPTG		
TEAK	PG	TBL 200H CPG	TBL 200H CEPPG	TBL 200H CSPG	
	ZU	TBL 200H CZU	TBL 200H CEPZU	TBL 200H CAZU	
	TK	TBL 200H W	TBL 200H WEP	TBL 200H WW	TBL 200H WS

TEA TIME

design by Frank Boschman

TEA TIME - TTM40TL...

TK: 0,015 m³ / A: 0,019 m³ TK: 4 kg / A: 7 kg



	TEAK TK	COATED ALUMINIUM WR	COATED ALUMINIUM S	COATED ALUMINIUM A	COATED ALUMINIUM BR
BS	TTM 40 TL CBS	TTM 40 TL CWRBS	TTM 40 TL CSBS	TTM 40 TL CABS	TTM 40 TL CBRBS
TG	TTM 40 TL CTG	TTM 40 TL CWTG	TTM 40 TL CSTG	TTM 40 TL CATG	TTM 40 TL CBRTG
WUM	TTM 40 TL CWUM	TTM 40 TL CWRWUM	TTM 40 TL CSWUM	TTM 40 TL CAWUM	TTM 40 TL CBRWUM
ZUM	TTM 40 TL CZUM	TTM 40 TL CWRZUM	TTM 40 TL CSZUM	TTM 40 TL CAZUM	TTM 40 TL CBRZUM
TR	TTM 40 TL CTR	TTM 40 TL CWRTR	TTM 40 TL CSTR	TTM 40 TL CATR	TTM 40 TL CBRTR
PG	TTM 40 TL CPG	TTM 40 TL CWRPG	TTM 40 TL CSPG	TTM 40 TL CAPG	TTM 40 TL CBRPG
CL	TTM 40 TL CCL	TTM 40 TL CWRCL	TTM 40 TL CSCL	TTM 40 TL CACL	TTM 40 TL CBRCL
VB	TTM 40 TL CVB	TTM 40 TL CWRVB	TTM 40 TL CSVB	TTM 40 TL CAVB	TTM 40 TL CBRVB

PP 18 - 19, 96

TEA TIME - TTM60T...

TK: 0,027 m³ / A: 0,025 m³ TK: 8,04 kg / A: 12,2 kg



	TEAK TK	COATED ALUMINIUM WR	COATED ALUMINIUM S	COATED ALUMINIUM A	COATED ALUMINIUM BR
BS	TTM 60 T CBS	TTM 60 T CWRBS	TTM 60 T CSBS	TTM 60 T CABS	TTM 60 T CBRBS
TG	TTM 60 T CTG	TTM 60 T CWTG	TTM 60 T CSTG	TTM 60 T CATG	TTM 60 T CBRTG
WUM	TTM 60 T CWUM	TTM 60 T CWRWUM	TTM 60 T CSWUM	TTM 60 T CAWUM	TTM 60 T CBRWUM
ZUM	TTM 60 T CZUM	TTM 60 T CWRZUM	TTM 60 T CSZUM	TTM 60 T CAZUM	TTM 60 T CBRZUM
TR	TTM 60 T CTR	TTM 60 T CWRTR	TTM 60 T CSTR	TTM 60 T CATR	TTM 60 T CBRTR
PG	TTM 60 T CPG	TTM 60 T CWRPG	TTM 60 T CSPG	TTM 60 T CAPG	TTM 60 T CBRPG
CL	TTM 60 T CCL	TTM 60 T CWRCL	TTM 60 T CSCL	TTM 60 T CACL	TTM 60 T CBRCL
VB	TTM 60 T CVB	TTM 60 T CWRVB	TTM 60 T CSVB	TTM 60 T CAVB	TTM 60 T CBRVB

PP 18 - 19, 96



TEA TIME HIGH - TTM60TH...

TK: 0,029 m³ / A: 0,025 m³ TK: 8,02 kg / A: 12,5 kg



	TEAK	COATED ALUMINIUM	COATED ALUMINIUM	COATED ALUMINIUM	COATED ALUMINIUM
	TK	WR	S	A	BR
BS	TTM 60 TH CBS	TTM 60 TH CWRBS	TTM 60 TH CSBS	TTM 60 TH CABS	TTM 60 TH CBRBS
TG	TTM 60 TH CTG	TTM 60 TH CWR TG	TTM 60 TH CSTG	TTM 60 TH CATG	TTM 60 TH CBR TG
WUM	TTM 60 TH CWUM	TTM 60 TH CWRWUM	TTM 60 TH CSWUM	TTM 60 TH CAWUM	TTM 60 TH CBRWUM
ZUM	TTM 60 TH CZUM	TTM 60 TH CWRZUM	TTM 60 TH CSZUM	TTM 60 TH CAZUM	TTM 60 TH CBRZUM
TR	TTM 60 TH CTR	TTM 60 TH CWRTR	TTM 60 TH CSTR	TTM 60 TH CATR	TTM 60 TH CBRTR
PG	TTM 60 TH CPG	TTM 60 TH CWRPG	TTM 60 TH CSPG	TTM 60 TH CAPG	TTM 60 TH CBRPG
CL	TTM 60 TH CCL	TTM 60 TH CWRCL	TTM 60 TH CSCCL	TTM 60 TH CACL	TTM 60 TH CBRCL
VB	TTM 60 TH CVB	TTM 60 TH CWRVB	TTM 60 TH CSVB	TTM 60 TH CAVB	TTM 60 TH CBRVB

TEA TIME HIGH - TTM75TH...

TK: 0,032 m³ / A: 0,03 m³ TK: 12,1 kg / A: 17,3 kg



	TEAK	COATED ALUMINIUM	COATED ALUMINIUM	COATED ALUMINIUM	COATED ALUMINIUM
	TK	WR	S	A	BR
BS	TTM 75 TH CBS	TTM 75 TH CWRBS	TTM 75 TH CSBS	TTM 75 TH CABS	TTM 75 TH CBRBS
TG	TTM 75 TH CTG	TTM 75 TH CWR TG	TTM 75 TH CSTG	TTM 75 TH CATG	TTM 75 TH CBR TG
WUM	TTM 75 TH CWUM	TTM 75 TH CWRWUM	TTM 75 TH CSWUM	TTM 75 TH CAWUM	TTM 75 TH CBRWUM
ZUM	TTM 75 TH CZUM	TTM 75 TH CWRZUM	TTM 75 TH CSZUM	TTM 75 TH CAZUM	TTM 75 TH CBRZUM
TR	TTM 75 TH CTR	TTM 75 TH CWRTR	TTM 75 TH CSTR	TTM 75 TH CATR	TTM 75 TH CBRTR
PG	TTM 75 TH CPG	TTM 75 TH CWRPG	TTM 75 TH CSPG	TTM 75 TH CAPG	TTM 75 TH CBRPG
CL	TTM 75 TH CCL	TTM 75 TH CWRCL	TTM 75 TH CSCCL	TTM 75 TH CACL	TTM 75 TH CBRCL
VB	TTM 75 TH CVB	TTM 75 TH CWRVB	TTM 75 TH CSVB	TTM 75 TH CAVB	TTM 75 TH CBRVB

TEA TIME - TTM75T...

TK: 0,031 m³ TK: 12 kg / A: 17 kg



	TEAK	COATED ALUMINIUM	COATED ALUMINIUM	COATED ALUMINIUM	COATED ALUMINIUM
	TK	WR	S	A	BR
BS	TTM 75 T CBS	TTM 75 T CWRBS	TTM 75 T CSBS	TTM 75 T CABS	TTM 75 T CBRBS
TG	TTM 75 T CTG	TTM 75 T CWR TG	TTM 75 T CSTG	TTM 75 T CATG	TTM 75 T CBR TG
WUM	TTM 75 T CWUM	TTM 75 T CWRWUM	TTM 75 T CSWUM	TTM 75 T CAWUM	TTM 75 T CBRWUM
ZUM	TTM 75 T CZUM	TTM 75 T CWRZUM	TTM 75 T CSZUM	TTM 75 T CAZUM	TTM 75 T CBRZUM
TR	TTM 75 T CTR	TTM 75 T CWRTR	TTM 75 T CSTR	TTM 75 T CATR	TTM 75 T CBRTR
PG	TTM 75 T CPG	TTM 75 T CWRPG	TTM 75 T CSPG	TTM 75 T CAPG	TTM 75 T CBRPG
CL	TTM 75 T CCL	TTM 75 T CWRCL	TTM 75 T CSCCL	TTM 75 T CACL	TTM 75 T CBRCL
VB	TTM 75 T CVB	TTM 75 T CWRVB	TTM 75 T CSVB	TTM 75 T CAVB	TTM 75 T CBRVB

TEA TIME - TTM100T...

TK: 0,042 m³ / A: 0,4 m³ TK: 13 kg / A: 17,4 kg



	TEAK	COATED ALUMINIUM	COATED ALUMINIUM	COATED ALUMINIUM	COATED ALUMINIUM
	TK	WR	S	A	BR
BS	TTM 100 T CBS	TTM 100 T CWRBS	TTM 100 T CSBS	TTM 100 T CABS	TTM 100 T CBRBS
TG	TTM 100 T CTG	TTM 100 T CWR TG	TTM 100 T CSTG	TTM 100 T CATG	TTM 100 T CBR TG
WUM	TTM 100 T CWUM	TTM 100 T CWRWUM	TTM 100 T CSWUM	TTM 100 T CAWUM	TTM 100 T CBRWUM
ZUM	TTM 100 T CZUM	TTM 100 T CWRZUM	TTM 100 T CSZUM	TTM 100 T CAZUM	TTM 100 T CBRZUM
TR	TTM 100 T CTR	TTM 100 T CWRTR	TTM 100 T CSTR	TTM 100 T CATR	TTM 100 T CBRTR
PG	TTM 100 T CPG	TTM 100 T CWRPG	TTM 100 T CSPG	TTM 100 T CAPG	TTM 100 T CBRPG
CL	TTM 100 T CCL	TTM 100 T CWRCL	TTM 100 T CSCCL	TTM 100 T CACL	TTM 100 T CBRCL
VB	TTM 100 T CVB	TTM 100 T CWRVB	TTM 100 T CSVB	TTM 100 T CAVB	TTM 100 T CBRVB

PP 46 - 47, 48 - 49

TEA TIME HIGH - TTM100TH...

TK: 0,042 m³ / A: 0,04 m³ TK: 13,15 kg / A: 17,7 kg



	TEAK TK	COATED ALUMINIUM WR	COATED ALUMINIUM S	COATED ALUMINIUM A	COATED ALUMINIUM BR
BS	TTM 100 TH CBS	TTM 100 TH CWRBS	TTM 100 TH CSBS	TTM 100 TH CABS	TTM 100 TH CBRBS
TG	TTM 100 TH CTG	TTM 100 TH CWR TG	TTM 100 TH CSTG	TTM 100 TH CATG	TTM 100 TH CBR TG
WUM	TTM 100 TH CWUM	TTM 100 TH CWRWUM	TTM 100 TH CSWUM	TTM 100 TH CAWUM	TTM 100 TH CBRWUM
ZUM	TTM 100 TH CZUM	TTM 100 TH CWRZUM	TTM 100 TH CSZUM	TTM 100 TH CAZUM	TTM 100 TH CBRZUM
TR	TTM 100 TH CTR	TTM 100 TH CWRTR	TTM 100 TH CSTR	TTM 100 TH CATR	TTM 100 TH CBRTR
PG	TTM 100 TH CPG	TTM 100 TH CWRPG	TTM 100 TH CSPG	TTM 100 TH CAPG	TTM 100 TH CBRPG
CL	TTM 100 TH CCL	TTM 100 TH CWRCL	TTM 100 TH CSCL	TTM 100 TH CACL	TTM 100 TH CBRCL
VB	TTM 100 TH CVB	TTM 100 TH CWRVB	TTM 100 TH CSVB	TTM 100 TH CAVB	TTM 100 TH CBRVB

TEA TIME HIGH - TTM120TH...

TK: 0,052 m³ / A: 0,043 m³ TK: 19,2 kg / A: 25,2 kg



	TEAK TK	COATED ALUMINIUM WR	COATED ALUMINIUM S	COATED ALUMINIUM A	COATED ALUMINIUM BR
BS	TTM 120 TH C BS	TTM 120 TH CWRBS	TTM 120 TH CSBS	TTM 120 TH CABS	TTM 120 TH CBRBS
TG	TTM 120 TH CTG	TTM 120 TH CWR TG	TTM 120 TH CSTG	TTM 120 TH CATG	TTM 120 TH CBR TG
WUM	TTM 120 TH CWUM	TTM 120 TH CWRWUM	TTM 120 TH CSWUM	TTM 120 TH CAWUM	TTM 120 TH CBRWUM
ZUM	TTM 120 TH CZUM	TTM 120 TH CWRZUM	TTM 120 TH CSZUM	TTM 120 TH CAZUM	TTM 120 TH CBRZUM
TR	TTM 120 TH CTR	TTM 120 TH CWRTR	TTM 120 TH CSTR	TTM 120 TH CATR	TTM 120 TH CBRTR
PG	TTM 120 TH CPG	TTM 120 TH CWRPG	TTM 120 TH CSPG	TTM 120 TH CAPG	TTM 120 TH CBRPG
CL	TTM 120 TH CCL	TTM 120 TH CWRCL	TTM 120 TH CSCL	TTM 120 TH CACL	TTM 120 TH CBRCL
VB	TTM 120 TH CVB	TTM 120 TH CWRVB	TTM 120 TH CSVB	TTM 120 TH CAVB	TTM 120 TH CBRVB

PP 46 - 47, 48 - 49

TEA TIME - TTM120T..

TK: 0,049 m³ / A: 0,043 m³ TK: 19 kg / A: 24,8 kg



	TEAK TK	COATED ALUMINIUM WR	COATED ALUMINIUM S	COATED ALUMINIUM A	COATED ALUMINIUM BR
BS	TTM 120 T CBS	TTM 120 T CWRBS	TTM 120 T CSBS	TTM 120 T CABS	TTM 120 T CBRBS
TG	TTM 120 T CTG	TTM 120 T CWR TG	TTM 120 T CSTG	TTM 120 T CATG	TTM 120 T CBR TG
WUM	TTM 120 T CWUM	TTM 120 T CWRWUM	TTM 120 T CSWUM	TTM 120 T CAWUM	TTM 120 T CBRWUM
ZUM	TTM 120 T CZUM	TTM 120 T CWRZUM	TTM 120 T CSZUM	TTM 120 T CAZUM	TTM 120 T CBRZUM
TR	TTM 120 T CTR	TTM 120 T CWRTR	TTM 120 T CSTR	TTM 120 T CATR	TTM 120 T CBRTR
PG	TTM 120 T CPG	TTM 120 T CWRPG	TTM 120 T CSPG	TTM 120 T CAPG	TTM 120 T CBRPG
CL	TTM 120 T CCL	TTM 120 T CWRCL	TTM 120 T CSCL	TTM 120 T CACL	TTM 120 T CBRCL
VB	TTM 120 T CVB	TTM 120 T CWRVB	TTM 120 T CSVB	TTM 120 T CAVB	TTM 120 T CBRVB

PP 44 - 45



TRAVERSE

design by Mathias De Ferm



FOLDING TABLE - TRV 80F...

0,48 m³ C: 23,4 kg



ROUND FOLDING TABLE - TRV 80FR

0,48 m³ C: 20,7 kg



FOLDING TABLE - TRV 150 F

0,12 m³ 25,8 kg



	COATED ALUMINIUM WR	COATED ALUMINIUM S	COATED ALUMINIUM A
WUM	TRV 80F CWRWUM	TRV 80F CSWUM	TRV 80F CAWUM
TG	TRV 80F CWRTG	TRV 80F CSTG	TRV 80F CATG
PG	TRV 80F CWRPG	TRV 80F CSPG	TRV 80F CAPG
ZUM	TRV 80F CWRZUM	TRV 80F CSZUM	TRV 80F CAZUM
TR	TRV 80F CWRTR	TRV 80F CSTR	TRV 80F CATR
BS	TRV 80F CWRBS	TRV 80F CSBS	TRV 80F CABS
CL	TRV 80F CWRCL	TRV 80F CSCL	TRV 80F CACL
VB	TRV 80F CWRVB	TRV 80F CSVB	TRV 80F CAVB
TEAK TK	TRV 80F WWR	TRV 80F WS	TRV 80F WA

PP 17, 84 - 85

	COATED ALUMINIUM WR	COATED ALUMINIUM S	COATED ALUMINIUM A
WUM	TRV 80FR CWRWUM	TRV 80FR CSWUM	TRV 80FR CAWUM
TG	TRV 80FR CWRTG	TRV 80FR CSTG	TRV 80FR CATG
PG	TRV 80FR CWRPG	TRV 80FR CSPG	TRV 80FR CAPG
ZUM	TRV 80FR CWRZUM	TRV 80FR CSZUM	TRV 80FR CAZUM
TR	TRV 80FR CWRTR	TRV 80FR CSTR	TRV 80FR CATR
BS	TRV 80FR CWRBS	TRV 80FR CSBS	TRV 80FR CABS
CL	TRV 80FR CWRCL	TRV 80FR CSCL	TRV 80FR CACL
VB	TRV 80FR CWRVB	TRV 80FR CSVB	TRV 80FR CAVB
TEAK TK	TRV 80FR WWR	TRV 80FR WS	TRV 80FR WA

	COATED ALUMINIUM WR	COATED ALUMINIUM S	COATED ALUMINIUM A
TEAK TK	TRV 150 FWR	TRV 150 FS	TRV 150 FA

PP 16, 86 - 87



TWIST

design by Kris Van Puyvelde

TWIST - TWS55...

0.39 m³ 10 kg



COATED ALUMINIUM
+ OLEFIN FIBER

BR

COATED ALU. BR TWS 55 DBR

CUSHIONS

PIL TWS55SRS...
(SEAT)

CAT. A •

CAT. B •

PIL TWS55BRS...
(BACK)

CAT. A •

CAT. B •

PP 88 - 89, 92



U-NITE

design by Kris Van Puyvelde

TABLE - UNT75...

A+C: 0,090 m³ / A+TK: 0,098 m³ / TK+C: 0,121 m³
 A+C: 24 kg / A+TK: 22,2 kg / TK+C: 25,6 kg

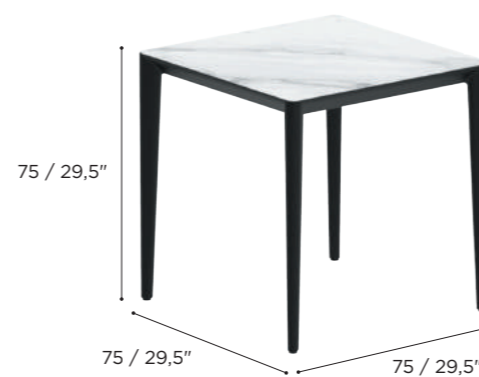

	COATED ALUMINIUM WR	COATED ALUMINIUM S	COATED ALUMINIUM A	COATED ALUMINIUM BR	TEAK TK
TG	UNT 75 CWR TG	UNT 75 CSTG	UNT 75 CATG	UNT 75 CBR TG	UNT 75 CTG
BS	UNT 75 CWR BS	UNT 75 CSBS	UNT 75 CABS	UNT 75 CBR BS	
CL	UNT 75 CWR CL	UNT 75 CSCL	UNT 75 CACL	UNT 75 CBR CL	
VB	UNT 75 CWR VB	UNT 75 CSVB	UNT 75 CAVB	UNT 75 CBR VB	
WUM	UNT 75 CWR WUM				
ZUM			UNT 75 CAZUM	UNT 75 CBRZUM	
PG		UNT 75 CSPG			
TR	UNT 75 CWR TR	UNT 75 CSTR	UNT 75 CATR	UNT 75 CBR TR	
TEAK TK	UNT 75 WWR	UNT 75 WS	UNT 75 WA	UNT 75 WBR	

PP 36 - 37

TABLE - UNT100...

A+C: 0,100 m³ / A+TK: 0,113 m³ / TK+C: 0,120 m³
 A+C: 34 kg / A+TK: 30,9 kg / TK+C: 35,6 kg

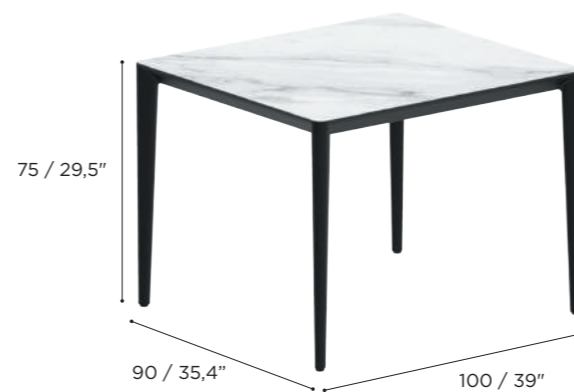

	COATED ALUMINIUM WR	COATED ALUMINIUM S	COATED ALUMINIUM A	COATED ALUMINIUM BR	TEAK TK
TG	UNT 100 CWR TG	UNT 100 CSTG	UNT 100 CATG	UNT 100 CBR TG	UNT 100 CTG
BS	UNT 100 CWR BS	UNT 100 CSBS	UNT 100 CABS	UNT 100 CBR BS	
CL	UNT 100 CWR CL	UNT 100 CSCL	UNT 100 CACL	UNT 100 CBR CL	
VB	UNT 100 CWR VB	UNT 100 CSVB	UNT 100 CAVB	UNT 100 CBR VB	
WUM	UNT 100 CWR WUM				
ZUM			UNT 100 CAZUM	UNT 100 CBRZUM	
PG		UNT 100 CSPG			
TR	UNT 100 CWR TR	UNT 100 CSTR	UNT 100 CATR	UNT 100 CBR TR	
TEAK TK	UNT 100 WWR	UNT 100 WS	UNT 100 WA	UNT 100 WBR	

TABLE - UNT150...

A+C: 0,155 m³ / A+TK: 0,172 m³ / TK+C: 0,179 m³
 A+C: 46,8 kg / A+TK: 42,6 kg / TK+C: 49,6 kg



	COATED ALUMINIUM WR	COATED ALUMINIUM S	COATED ALUMINIUM A	COATED ALUMINIUM BR	TEAK TK
TG	UNT 150 CWR TG	UNT 150 CSTG	UNT 150 CATG	UNT 150 CBR TG	UNT 150 CTG
BS	UNT 150 CWR BS	UNT 150 CSBS	UNT 150 CABS	UNT 150 CBR BS	
CL	UNT 150 CWR CL	UNT 150 CSCL	UNT 150 CACL	UNT 150 CBR CL	
VB	UNT 150 CWR VB	UNT 150 CSVB	UNT 150 CAVB	UNT 150 CBR VB	
WUM	UNT 150 CWR WUM				
ZUM			UNT 150 CAZUM	UNT 150 CBRZUM	
PG		UNT 150 CSPG			
TR	UNT 150 CWR TR	UNT 150 CSTR	UNT 150 CATR	UNT 150 CBR TR	
TK	UNT 150 WWR	UNT 150 WS	UNT 150 WA	UNT 150 WBR	

TABLE - UNT300...

A+C: 0,388 m³ / A+TK: 0,472 m³ / TK+C: 0,391 m³
 A+C: 102 kg / A+TK: 93,5 kg / TK+C: 102,6 kg

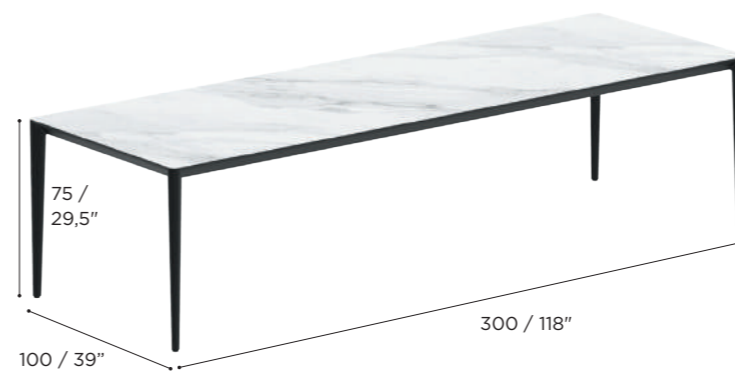

	COATED ALUMINIUM WR	COATED ALUMINIUM S	COATED ALUMINIUM A	COATED ALUMINIUM BR	TEAK TK
TG	UNT 300 CWR TG	UNT 300 CSTG	UNT 300 CATG	UNT 300 CBR TG	UNT 300 CTG
BS	UNT 300 CWR BS	UNT 300 CSBS	UNT 300 CABS	UNT 300 CBR BS	
CL	UNT 300 CWR CL	UNT 300 CSCL	UNT 300 CACL	UNT 300 CBR CL	
VB	UNT 300 CWR VB	UNT 300 CSVB	UNT 300 CAVB	UNT 300 CBR VB	
WUM	UNT 300 CWR WUM				
ZUM			UNT 300 CAZUM	UNT 300 CBRZUM	
PG		UNT 300 CSPG			
TR	UNT 300 CWR TR	UNT 300 CSTR	UNT 300 CATR	UNT 300 CBR TR	
TK	UNT 300 WWR	UNT 300 WS	UNT 300 WA	UNT 300 WBR	

PP 90 - 91

TABLE - UNT220...

A+C: 0,281 m³ / A+TK: 0,309 m³ / TK+C: 0,287 m³
 A+C: 77,7 kg / A+TK: 71 kg / TK+C: 77,6 kg



	COATED ALUMINIUM WR	COATED ALUMINIUM S	COATED ALUMINIUM A	COATED ALUMINIUM BR	TEAK TK
TG	UNT 220 CWR TG	UNT 220 CSTG	UNT 220 CATG	UNT 220 CBR TG	UNT 220 CTG
BS	UNT 220 CWR BS	UNT 220 CSBS	UNT 220 CABS	UNT 220 CBR BS	
CL	UNT 220 CWR CL	UNT 220 CSCL	UNT 220 CACL	UNT 220 CBR CL	
VB	UNT 220 CWR VB	UNT 220 CSVB	UNT 220 CAVB	UNT 220 CBR VB	
WUM	UNT 220 CWR WUM				
ZUM			UNT 220 CAZUM	UNT 220 CBRZUM	
PG		UNT 220 CSPG			
TR	UNT 220 CWR TR	UNT 220 CSTR	UNT 220 CATR	UNT 220 CBR TR	
TK	UNT 220 WWR	UNT 220 WS	UNT 220 WA	UNT 220 WBR	

PP 92 - 93, 110

VIGOR

design by Frank Boschman

STOOL - VGR50...

0,06 m³ 15,5 kg

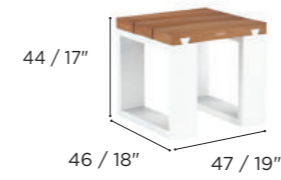

BENCH - VGR318...

0,37 m³ 61 kg



TABLE - VGR320...

0,70 m³ 128 kg



		COATED ALUMINIUM	COATED ALUMINIUM	COATED ALUMINIUM
		WR	S	A
TEAK	TK	VGR 50 WWR	VGR 50 WS	VGR 50 WA
MAH.	MH	VGR 50 MHWR	VGR 50 MHS	VGR 50 MHA
CUSHIONS				
PIL VGR 50 ...				
CAT. A				
CAT. B				
PP 94				

		COATED ALUMINIUM	COATED ALUMINIUM	COATED ALUMINIUM
		WR	S	A
TEAK	TK	VGR 318 WWR	VGR 318 WS	VGR 318 WA
MAH.	MH	VGR 318 MHWR	VGR 318 MHS	VGR 318 MHA
CUSHIONS				
PIL VGR 318 ...				
CAT. A				
CAT. B				
PP 94				

		COATED ALUMINIUM	COATED ALUMINIUM	COATED ALUMINIUM
		WR	S	A
TEAK	TK	VGR 320 WWR	VGR 320 WS	VGR 320 WA
MAH.	MH	VGR 320 MHWR	VGR 320 MHS	VGR 320 MHA
CUSHIONS				
PIL VGR 320 ...				
CAT. A				
CAT. B				
PP 94				



VIGOR LOUNGE

design by Frank Boschman

STANDARD OFFER FOR VIGOR LOUNGE COLLECTION (CATEGORY B FABRICS)

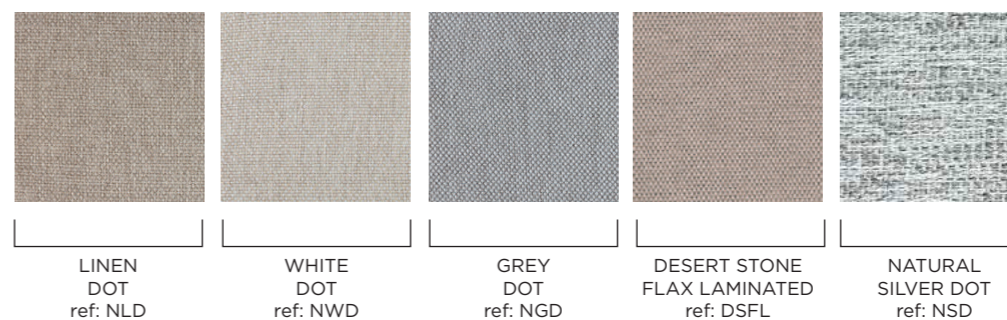

ALL OTHER FABRICS AVAILABLE ON REQUEST - PP 270 - 273



CORNER MODULE - VGRL100...

0,06 m³ 15,5 kg

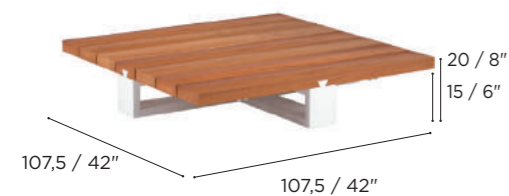

LOW TABLE / LOUNGE MODULE - VGRL150T...

0,06 m³ 15,5 kg



DAYBED / LOUNGE MODULE - VGRL200...

0,06 m³ 15,5 kg



LOUNGE MODULE - VGRL300...

0,06 m³ 15,5 kg



TRAY - VGRLTRAY..

0,06 m³ 15,5 kg

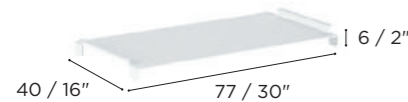

		COATED ALUMINIUM	COATED ALUMINIUM	COATED ALUMINIUM
		WR	S	A
TEAK	TK	VGRL 100 WWR	VGRL 100 WS	VGRL 100 WA
MAH.	MH	VGRL 100 MHWR	VGRL 100 MHS	VGRL 100 MHA
		•	•	•
		•	•	•

PP 94, 95

		COATED ALUMINIUM	COATED ALUMINIUM	COATED ALUMINIUM
		WR	S	A
TEAK	TK	VGRL 150T WWR	VGRL 150T WS	VGRL 150T WA
MAH.	MH	VGRL 150T MHWR	VGRL 150T MHS	VGRL 150T MHA
		•	•	•
		•	•	•

PP 94

		COATED ALUMINIUM	COATED ALUMINIUM	COATED ALUMINIUM
		WR	S	A
TEAK	TK	VGRL 200 WWR	VGRL 200 WS	VGRL 200 WA
MAH.	MH	VGRL 200 MHWR	VGRL 200 MHS	VGRL 200 MHA
		•	•	•
		•	•	•

PP 94, 95

		COATED ALUMINIUM	COATED ALUMINIUM	COATED ALUMINIUM
		WR	S	A
TEAK	TK	VGRL 300 WWR	VGRL 300 WS	VGRL 300 WA
MAH.	MH	VGRL 300 MHWR	VGRL 300 MHS	VGRL 300 MHA
		•	•	•
		•	•	•

PP 94, 95, 96, 97

		COATED ALUMINIUM	COATED ALUMINIUM	COATED ALUMINIUM
		WR	S	A
		VGRL TRAY WR	VGRL TRAY S	VGRL TRAY A
		•	•	•

MODULAR LOUNGE CUSHIONS

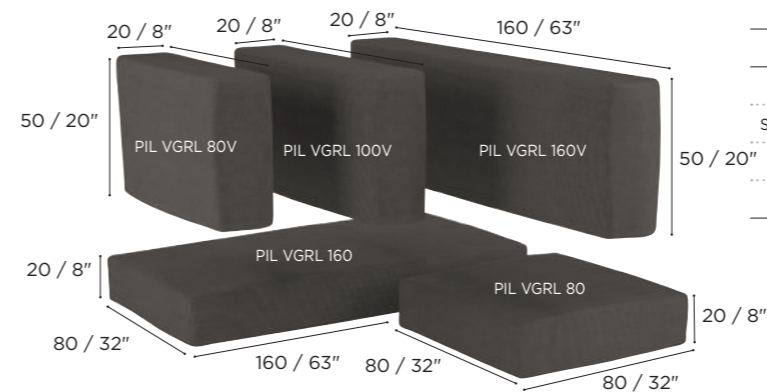

CUSHIONS FOR VIGOR LOUNGE	
BACK / ARM 80 x 60	
	PIL VGRL 80V...
STANDARD	•
CAT. A	•
CAT. B	•
BACK / ARM 100 x 60	
	PIL VGRL 100V...
STANDARD	•
CAT. A	•
CAT. B	•

CUSHIONS FOR VIGOR LOUNGE	
BACK / ARM 160 x 60	
	PIL VGRL 160V...
STANDARD	•
CAT. A	•
CAT. B	•
SEAT 80 x 80	
	PIL VGRL 80...
STANDARD	•
CAT. A	•
CAT. B	•
SEAT 160 x 80	
	PIL VGRL 160...
STANDARD	•
CAT. A	•
CAT. B	•

COMFORT CUSHIONS

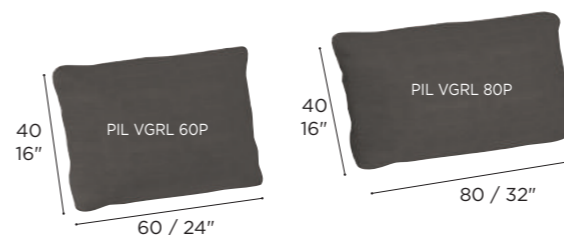

CUSHIONS FOR VIGOR LOUNGE	
BACK / ARM 60 x 40	
	PIL VGRL 60P...
STANDARD	•
CAT. A	•
CAT. B	•
BACK / ARM 80 x 40	
	PIL VGRL 80P...
STANDARD	•
CAT. A	•
CAT. B	•

CUSHIONS FOR VIGOR LOUNGE	
BACK 50 x 93	
	PIL VGRL 90V...
STANDARD	•
CAT. A	•
CAT. B	•
COMFORT 40 x 90	
	PIL VGRL 90P...
STANDARD	•
CAT. A	•
CAT. B	•
SEAT 194 x 93	
	PIL VGRL 195...
STANDARD	•
CAT. A	•
CAT. B	•

VIGOR LOUNGE DAYBED CUSHIONS

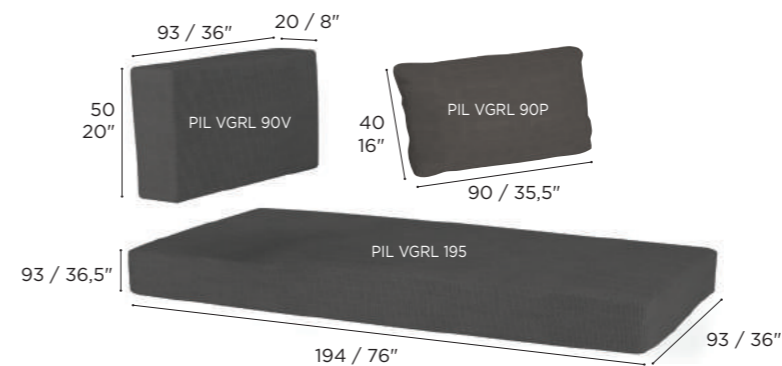

VIGOR LOUNGE DAYBED MAHOGANY WITH LAMINATED FABRIC



VGRL DAYBED

INCLUDED

- 1 x VGRL 200 MH
- 1 x PIL VGRL 195
- 1 x PIL VGRL 90 V
- 1 x PIL VGRL 90 P

* = PRICE FOR WHITE COATED ALUMINIUM FRAME WITH CATEGORY B STANDARD CUSHIONS

VIGOR LOUNGE SET 03 MAHOGANY WITH LAMINATED FABRIC



VGRL SET 03

INCLUDED

- 1 x VGRL 300 MH
- 1 x VGRL 200 MH
- 2 x PIL VGRL 100V
- 4 x PIL VGRL 80V
- 2 x PIL VGRL 160
- 4 x PIL VGRL 80P
- 1 x PIL VGRL 60P
- 2 x PIL 40M

* = PRICE FOR WHITE COATED ALUMINIUM FRAME WITH CATEGORY B STANDARD CUSHIONS

VIGOR LOUNGE SET 01 MAHOGANY WITH LAMINATED FABRIC



VGRL SET 01

INCLUDED

- 1 x VGRL 300 MH
- 1 x PIL VGRL 160V
- 1 x PIL VGRL 100V
- 1 x PIL VGRL 160
- 2 x PIL VGRL 80P
- 1 x PIL 40M

* = PRICE FOR WHITE COATED ALUMINIUM FRAME WITH CATEGORY B STANDARD CUSHIONS

VIGOR LOUNGE SET 04 MAHOGANY WITH LAMINATED FABRIC



VGRL SET 04

INCLUDED

- 1 x VGRL 300 MH
- 1 x VGRL 200 MH
- 1 x VGRL 150T MH
- 1 x VGRL 100 MH
- 3 x PIL VGRL 160V
- 2 x PIL VGRL 100V
- 3 x PIL VGRL 160
- 6 x PIL VGRL 80P
- 1 x PIL VGRL 60P
- 3 x PIL 40M

* = PRICE FOR WHITE COATED ALUMINIUM FRAME WITH CATEGORY B STANDARD CUSHIONS

VIGOR LOUNGE SET 02 MAHOGANY WITH LAMINATED FABRIC



VGRL SET 02

INCLUDED

- 2 x VGRL 300 MH
- 2 x PIL VGRL 100V
- 5 x PIL VGRL 80V
- 5 x PIL VGRL 80
- 5 x PIL VGRL 80P
- 3 x PIL 40M

* = PRICE FOR WHITE COATED ALUMINIUM FRAME WITH CATEGORY B STANDARD CUSHIONS

VIGOR LOUNGE SET 05 MAHOGANY WITH LAMINATED FABRIC



VGRL SET 05

INCLUDED

- 1 x VGRL 300 MH
- 3 x VGRL 200 MH
- 1 x VGRL 100 MH
- 4 x PIL VGRL 160V
- 3 x PIL VGRL 100V
- 4 x PIL VGRL 160
- 8 x PIL VGRL 80P
- 1 x PIL VGRL 60P
- 5 x PIL 40M

* = PRICE FOR WHITE COATED ALUMINIUM FRAME WITH CATEGORY B STANDARD CUSHIONS

WAVE

design by Gustav Störm & Erik Nyberg



HAMMOCK - WVEP...

3,85 m³ 238 kg

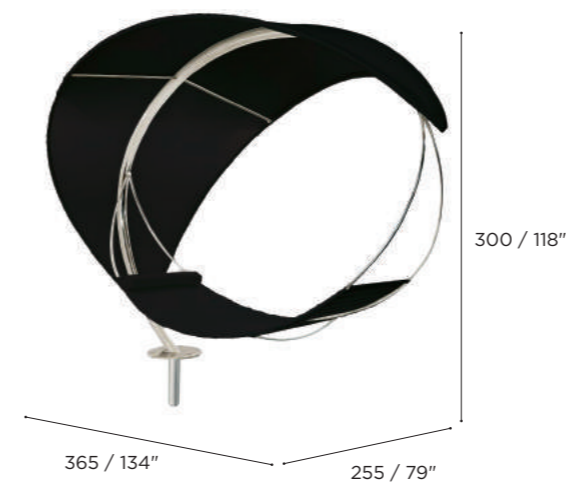

STAINLESS STEEL ELECTRO POLISHED	
WU	WV EPWU
CAU	WV EPCAU
BATYLINE	WV EPZU
	WV EPTQF
PP 98, 99, 100 - 101	

HAMMOCK CUSHION - PILWV...

0,47 m³ 35 kg

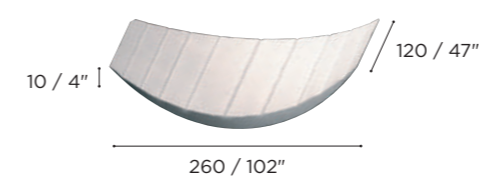

PIL WV ...	
CAT. A	•
CAT. B	•

- STORAGE BAG AND HEAD CUSHION INCLUDED
- SAC DE RANGEMENT ET APPUI-TÊTE COMPRIS
- TRAGETASCHE UND KOPFSTÜTZEN INKLUSIVE
- OPBERGHOES EN HOOFDKUSSEN INBEGREPEN
- BORSA PER RIPORRE E CUSCINO POGGIATESTA INCLUSI
- BOLSO PARA GUARDAR Y CABEZAL INLCUIDOS

BASE FOR CONCRETE GROUND - WVT

2,28 m³ 183 kg

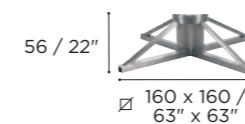

STAINLESS STEEL ELECTRO POLISHED	
WVT	

- BASE FOR EMBEDDING IN CONCRETE
- BASE POUR INCRUSTATION DANS LE BÉTON
- BASIS FÜR EINBETTUNG IN BETON
- BASIS VOOR INBOUW IN BETON
- BASE PER FISSAGGIO NEL CEMENTO
- BASE PARA CONSTRUCCIÓN CON CEMENTO

BASE FOR SAND GROUND - WVG

2,28 m³ 225 kg

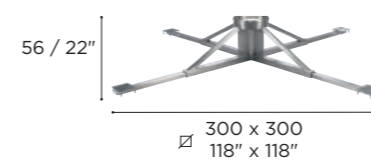

STAINLESS STEEL ELECTRO POLISHED	
WVG	

- BASE FOR EMBEDDING IN SAND
- BASE POUR INCRUSTATION DANS LE SABLE
- BASIS FÜR DIE EINBETTUNG IN SAND
- BASIS VOOR INBOUW IN ZANDBODEM
- BASE PER FISSAGGIO NELLA SABBIA
- BASE PARA ENTERRAR

XQI

design by Kris Van Puyvelde



CHAIR - XQI55...

0,37 m³ (2) 7,6 kg

81 / 32"
65 / 26"
44 / 17"
57 / 23" 59,5 / 23"

TEAK

TK

WU XQI 55 TEPWU

BATYLINE BRU XQI 55 TEPBRU

ZU XQI 55 TEPZU

PP 106, 107

LOUNGER - XQI195...

0,37 m³ (2) 32,8 kg

195 / 77"
42,5 / 17"
70,5 / 28"

TEAK

TK

WU XQI 195 TEPWU

BATYLINE BRU XQI 195 TEPBRU

ZU XQI 195 TEPZU

PP 104 - 105, 108 - 109

SIDE TABLE - XQI50...

0,22 m³ 5 kg

36 / 14"
50 / 20" 50 / 20"

TEAK

TK

XQI 50 W

LOW TABLE - XQI70T...

0,16 m³ 10,3 kg

36 / 14"
70 / 28" 70 / 28"

TEAK

TK

XQI 70T W

PP 104 - 105

RELAX CHAIR - XQI77...

0,34 m³ (4) 7,3 kg

70,5 / 32"
57 / 22,5"
34,5 / 13,5"
59 / 23" 61,5 / 24"

TEAK

TK

WU XQI 77 TEPWU

BATYLINE BRU XQI 77 TEPBRU

ZU XQI 77 TEPZU

PP 104 - 105

FOLDING CHAIR - XQI55F...

0,17 m³ (2) 9 kg

88 / 35"
67 / 26"
46 / 18"
57 / 22" 59 / 23"

TEAK

TK

WU XQI 55F TEPWU

BATYLINE BRU XQI 55F TEPBRU

ZU XQI 55F TEPZU

PP 24 - 25, 86 - 87

TABLE - XQI80...

0,10 m³ 15,2 kg

75 / 29"
80 / 31" 80 / 31"

TEAK

TK

XQI 80 W

TABLE - XQI180...

0,16 m³ 26,6 kg

75 / 29"
180 / 71" 90 / 35"

TEAK

TK

XQI 180 W

BAR CHAIR - XQI43...

0,31 m³ 8,8 kg

113 / 44"
101 / 40"
79 / 31"
53,5 / 21" 52 / 20"

TEAK

TK

WU XQI 43 TEPWU

BATYLINE BRU XQI 43 TEPBRU

ZU XQI 43 TEPZU

PP 102, 103, 104 - 105

BAR TABLE - XQI200H...

1,54 m³ 34,7 kg

103,5 / 40"
200 / 79" 70 / 28"

TEAK

TK

XQI 200H W

PP 102, 104 - 105

TABLE - XQI240...

0,23 m³ 37,6 kg

75 / 29"
240 / 95" 100 / 39"

TEAK

TK

XQI 240 W

PP 107

ZENHIT

design by Kris Van Puyvelde

STANDARD OFFER FOR ZENHIT LOUNGE COLLECTION (CATEGORY B FABRICS)

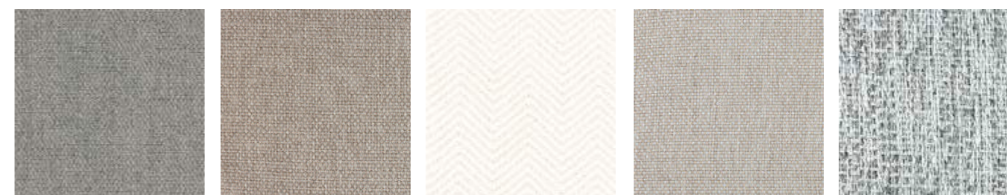

DESERT STONE
FLAX LAMINATED
ref: DSFL

LINEN
DOT
ref: NLD

CHEVRON
WHITE
ref: NCW

WHITE
DOT
ref: NWD

NATURAL
SILVER DOT
ref: NSD

ALL OTHER FABRICS AVAILABLE ON REQUEST - PP 270 - 273



ARM CHAIR - ZNT55

0,25 m³ 9 kg

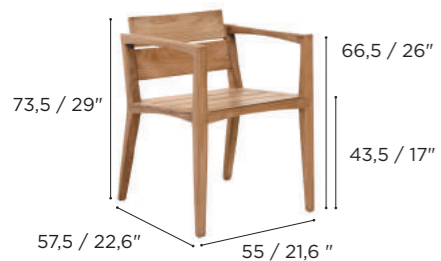

TEAK

TK

ZNT 55

CUSHIONS

PIL ZNT55BRS... (BACK)

- STANDARD •
- CAT. A •
- CAT. B •

PIL ZNT55SRS... (SEAT)

- STANDARD •
- CAT. A •
- CAT. B •

PP 110, 111

LOW TABLE - ZNTL150T...

0,32 m³ 24,3 kg



TEAK

TK

ZNTL150T

PP 113

CORNER MODULE - ZNTL80C...

0,48 m³ 20,3 kg



TEAK

TK

ZNTL 80C

CUSHIONS

PIL ZNTL 80C... (5pcs)

- STANDARD •
- CAT. A •
- CAT. B •

PP 114 - 115

TWO SEATER MODULE - ZNTL160Z...

0,40 m³ 27,5 kg



TEAK

TK

ZNTL 160Z

CUSHIONS

PIL ZNTL 160... (5pcs)

- STANDARD •
- CAT. A •
- CAT. B •

2x PIL ZNTL 100... (6pcs)

- STANDARD •
- CAT. A •
- CAT. B •

PP 114 - 115

ARM CHAIR - ZNTL100

0,15 m³ 22,9 kg



TEAK

TK

ZNTL 100

CUSHIONS

PIL ZNTL 100... (3pcs)

- STANDARD •
- CAT. A •
- CAT. B •

PP 113, 116

FOOTREST - ZNTL75T...

0,18 m³ 15,1 kg



TEAK

TK

ZNTL 75T

CUSHIONS

PIL ZNTL75T... (1pc)

- STANDARD •
- CAT. A •
- CAT. B •

PP 114 - 115, 116

TWO SEATER MODULE - ZNTL160R/L...

0,91 m³ 31 kg

ZNTL160R



ZNTL160L



TEAK

TK

ZNTL 160R

ZNTL 160L

CUSHIONS

PIL ZNTL 160... (5pcs)

- STANDARD •
- CAT. A •
- CAT. B •

2x PIL ZNTL 100... (6pcs)

- STANDARD •
- CAT. A •
- CAT. B •

ARM CHAIR - ZNTL160...

0,91 m³ 35 kg



TEAK

TK

ZNTL 160

CUSHIONS

PIL ZNTL 160... (5pcs)

- STANDARD •
- CAT. A •
- CAT. B •

2x PIL ZNTL 100... (6pcs)

- STANDARD •
- CAT. A •
- CAT. B •

THREE SEATER - ZNTL240...

1,33 m³ 54 kg



TEAK

TK

ZNTL 240

CUSHIONS

PIL ZNTL 240... (7pcs)

- STANDARD •
- CAT. A •
- CAT. B •

3x PIL ZNTL 100... (9pcs)

- STANDARD •
- CAT. A •
- CAT. B •

PP 112, 113

THREE SEATER MODULE - ZNTL240R/L...

1,33 m³ 50 kg

ZNTL240R



ZNTL240L



TEAK

TK

ZNTL 240R

ZNTL 240L

CUSHIONS

PIL ZNTL 240... (7pcs)

- STANDARD •
- CAT. A •
- CAT. B •

3x PIL ZNTL 100... (9pcs)

- STANDARD •
- CAT. A •
- CAT. B •

PP 114 - 115

DAYBED MODULE - ZNTLDBR/DBL...

0,55 m³ 40,0 kg

ZNTL160DBR



ZNTL160DBL



TEAK

TK

ZNTL DBR

ZNTL DBL

CUSHIONS

PIL ZNTLDB...
(3pcs)

STANDARD

CAT. A

CAT. B

PP 113, 114 - 115, 116, 117

ZENHIT MODULAR LOUNGE



ZIDIZ

design by Kris Van Puyvelde

STANDARD ON REQUEST

ARM CHAIR - ZDZ55...

0,35 m³ 8,2 kg

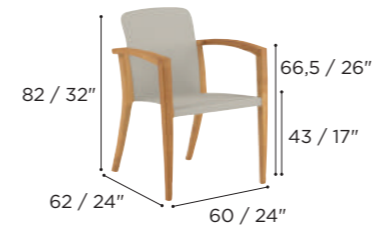

TEAK	
TK	
WU	ZDZ 55 WU
S	ZDZ 55 S
A	ZDZ 55 A
BR	ZDZ 55 BR
COATED ALUMINIUM	
CUSHIONS	
PIL ZDZ 55...	
CAT. A	•
CAT. B	•
PP 118 - 119	

BENCH - ZDZ154...

0,84 m³ 21,8 kg

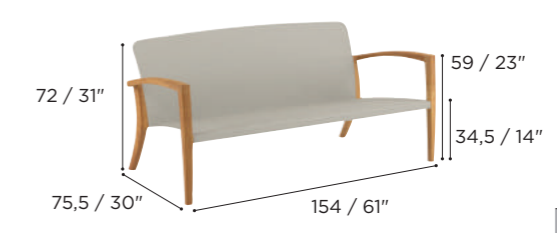

TEAK	
TK	
WU	ZDZ 154 WU
S	ZDZ 154 S
A	ZDZ 154 A
BR	ZDZ 154 BR
COATED ALUMINIUM	
CUSHIONS	
PIL ZDZ 154...	
CAT. A	•
CAT. B	•
PP 120, 121	

RELAX CHAIR - ZDZ77...

0,36 m³ 10,2 kg

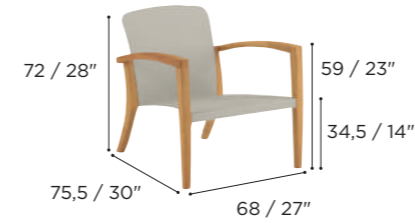

TEAK	
TK	
WU	ZDZ 77 WU
S	ZDZ 77 S
A	ZDZ 77 A
BR	ZDZ 77 BR
COATED ALUMINIUM	
CUSHIONS	
PIL ZDZ 77...	
CAT. A	•
CAT. B	•
PP 120	

FOOTREST - ZDZF...

0,09 m³ 4,6 kg

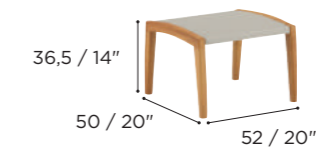

TEAK	
TK	
WU	ZDZ F WU
S	ZDZ F S
A	ZDZ F A
BR	ZDZ F BR
COATED ALUMINIUM	
CUSHIONS	
PIL ZDZ FT...	
CAT. A	•
CAT. B	•

LOUNGER - ZDZ195...

0,64 m³ 27,6 kg

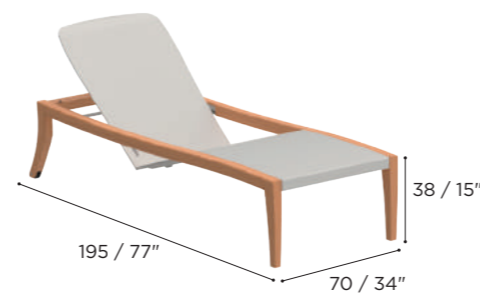

TEAK	
TK	
WU	ZDZ 195 WU
S	ZDZ 195 S
A	ZDZ 195 A
BR	ZDZ 195 BR
COATED ALUMINIUM	
CUSHIONS	
PIL ZDZ 195...	
CAT. A	•
CAT. B	•

SIDE TABLE - ZDZ50...

0,09 m³ 6,0 kg



TEAK	
TK	
SOLID SURFACE	CRN ZDZ 50 CRN WU
WUM	ZDZ 50 CWUM
CERAMIC	ZUM ZDZ 50 CZUM
TR	ZDZ 50 CTR
VB	ZDZ 50 CVB
PP 120	



LOW SIDE TABLE - ZDZ150T...

0,49 m³ C: 22,8 kg



		TEAK
		TK
SOLID SURFACE	CRN	ZDZ 150T CRNWU
	WUM	ZDZ 150T CWUM
CERAMIC	ZUM	ZDZ 150T CZUM
	TR	ZDZ 150T CTR
	VB	ZDZ 150T CVB
	PP 120	

ROUND TABLE - ZDZ130...

0,68 m³ S: 41,5 kg

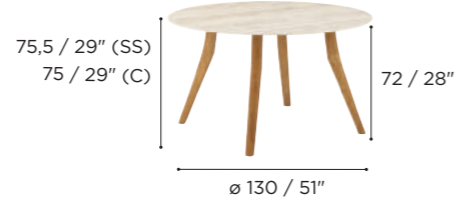

		TEAK
		TK
SOLID SURFACE	CRN	ZDZ 130 CRNWU
	WUM	ZDZ 130 CWUM
CERAMIC	ZUM	ZDZ 130 CZUM
	TR	ZDZ 130 CTR
	VB	ZDZ 130 CVB

TABLE - ZDZ220...

1,98 m³ C: 52,2 kg



		COATED ALUMINIUM	COATED ALUMINIUM	COATED ALUMINIUM	COATED ALUMINIUM	TEAK
		WR	S	A	BR	TK
SOLID SURFACE	CRN	ZDZ 220 CRNWRWU	ZDZ 220 CRNSWU	ZDZ 220 CRNAWU	ZDZ 220 CRNBRWU	ZDZ 220 CRNWU
	WUM	ZDZ 220 CWRWUM	ZDZ 220 CSWUM	ZDZ 220 CAWUM	ZDZ 220 CBRWUM	ZDZ 220 CWUM
CERAMIC	ZUM	ZDZ 220 CWRZUM	ZDZ 220 CSZUM	ZDZ 220 CAZUM	ZDZ 220 CBRZUM	ZDZ 220 CZUM
	TR	ZDZ 220 CWRTR	ZDZ 220 CSTR	ZDZ 220 CATR	ZDZ 220 CBRTR	ZDZ 220 CTR
	BS	ZDZ 220 CWRBS	ZDZ 220 CSBS	ZDZ 220 CABS	ZDZ 220 CBRBS	ZDZ 220 CBS
	VB	ZDZ 220 CWRVB	ZDZ 220 CSVB	ZDZ 220 CAVB	ZDZ 220 CBRVB	ZDZ 220 CVB
	TEAK	ZDZ 220 WWR	ZDZ 220 WS	ZDZ 220 WA	ZDZ 220 WBR	ZDZ 220
	PP 78					

EXTENDABLE TABLE - ZDZ320...

2,0 m³ W: 97,5 kg

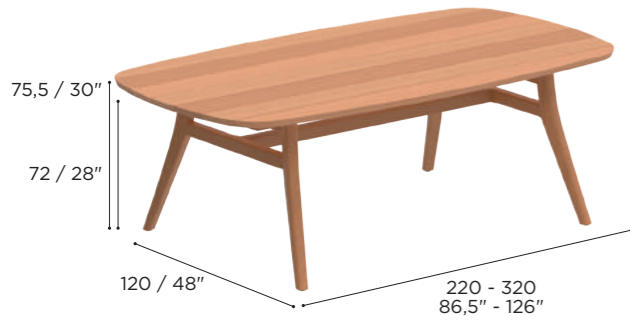

		COATED ALUMINIUM	COATED ALUMINIUM	COATED ALUMINIUM	COATED ALUMINIUM	TEAK
		WR	S	A	BR	TK
TEAK	TK	ZDZ 320 WWR	ZDZ 320 WS	ZDZ 320 WA	ZDZ 320 WBR	ZDZ 320
PP 122, 123						

TABLE - ZDZ300...

2,5 m³ CRN: 92,5 kg



		COATED ALUMINIUM	COATED ALUMINIUM	COATED ALUMINIUM	COATED ALUMINIUM	TEAK
		WR	S	A	BR	TK
SOLID SURFACE	CRN	ZDZ 300 CRNWRWU	ZDZ 300 CRNSWU	ZDZ 300 CRNAWU	ZDZ 300 CRNBRWU	ZDZ 300 CRNWU
	WUM	ZDZ 300 CWRWUM	ZDZ 300 CSWUM	ZDZ 300 CAWUM	ZDZ 300 CBRWUM	ZDZ 300 CWUM
CERAMIC	ZUM	ZDZ 300 CWRZUM	ZDZ 300 CSZUM	ZDZ 300 CAZUM	ZDZ 300 CBRZUM	ZDZ 300 CZUM
	TR	ZDZ 300 CWRTR	ZDZ 300 CSTR	ZDZ 300 CATR	ZDZ 300 CBRTR	ZDZ 300 CTR
	BS	ZDZ 300 CWRBS	ZDZ 300 CSBS	ZDZ 300 CABS	ZDZ 300 CBRBS	ZDZ 300 CBS
	VB	ZDZ 300 CWRVB	ZDZ 300 CSVB	ZDZ 300 CAVB	ZDZ 300 CBRVB	ZDZ 300 CVB
	TEAK	ZDZ 300 WWR	ZDZ 300 WS	ZDZ 300 WA	ZDZ 300 WBR	ZDZ 300
	PP 118					

UMBRELLAS

design by Kris Van Puyvelde



PALMA - PLM300...

0,40 m³ UMBRELLA 0,19 m³ BASE 59 kg - BASE INCLUDED



reddot design award
best of the best

STANDARD ON REQUEST

	COATED ALUMINIUM	COATED ALUMINIUM	COATED ALUMINIUM
	WR	S	A
WU	PLM300 WRWU	PLM300 SWU	PLM300 AWU
CAU	PLM300 WRCAU	PLM300 SCAU	PLM300 ACAU
ZU	PLM300 WRZU	PLM300 SZU	PLM300 AZU

PP 96, 124 - 125

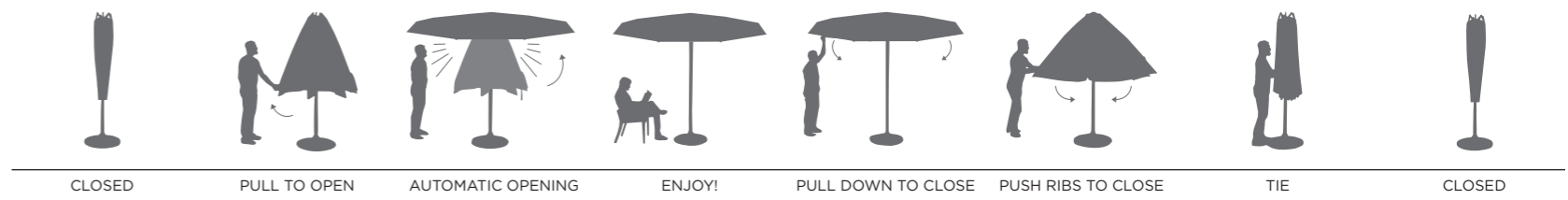
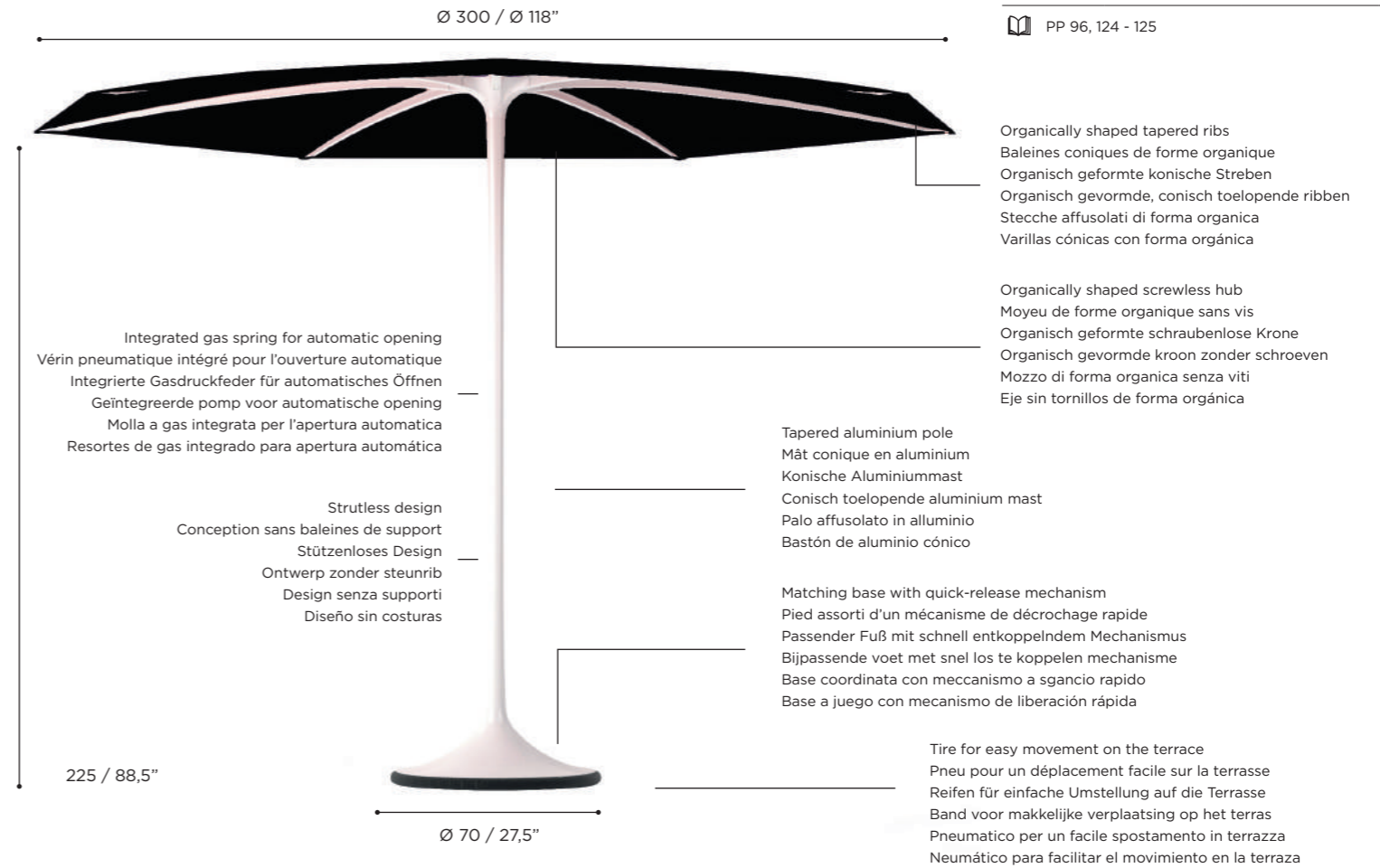

BALLAST PALMA - PLM300BALLAST

7,5 kg

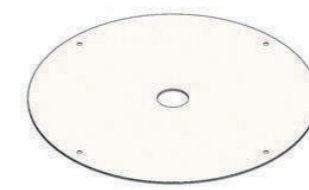

55 / 21,5" 4 / 1,5"

BALLAST

PLM300BALLAST

FEATURES

- * ROUND PLATE IN GALVANIZED STEEL
- * 4 SCREW HOLES
- * CENTRAL HOLE IN THE MIDDLE

SHADY UMBRELLA WITH TEAK POLE AND TEAK RIBS

0,20 m² - BASE NOT INCLUDED

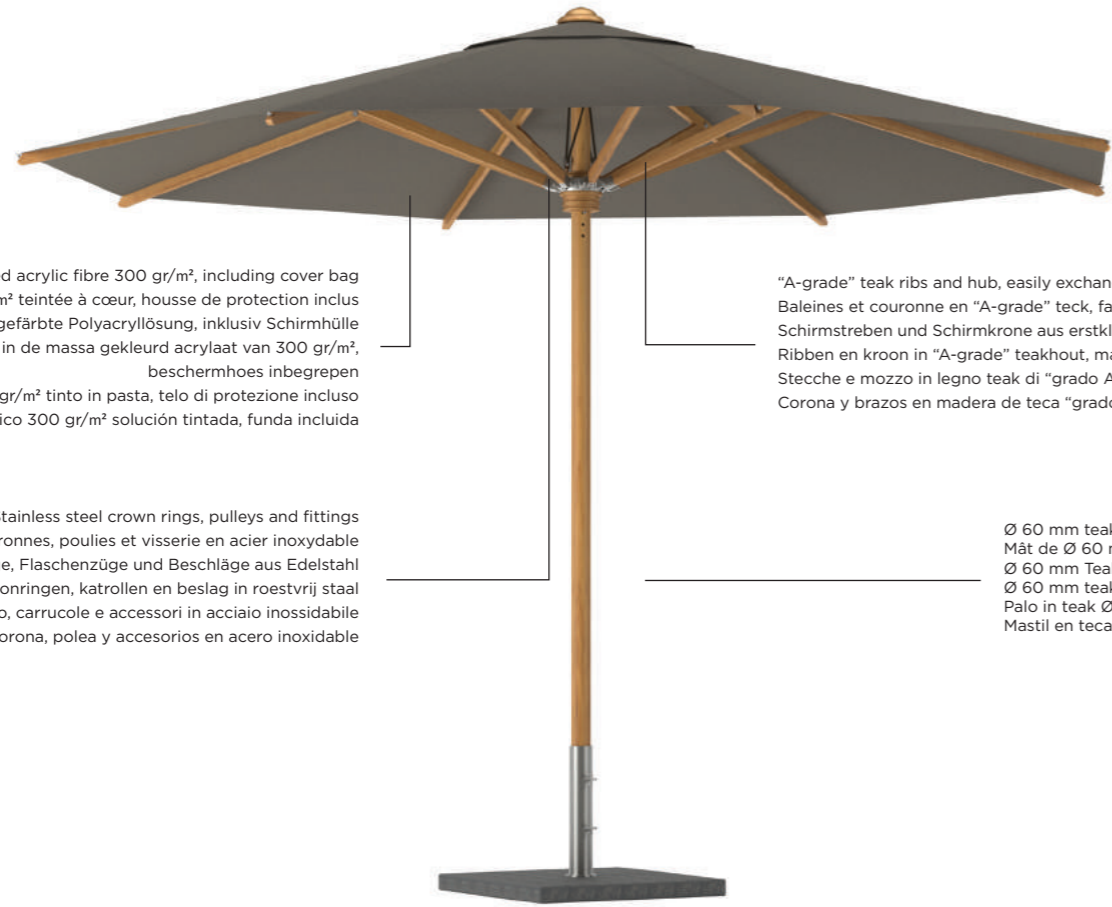

Cover solution dyed acrylic fibre 300 gr/m², including cover bag
 Toile en fibre acrylique 300 gr/m² teintée à cœur, housse de protection inclus
 Bespannung aus 300 gr/m² gefärbte Polyacryllösung, inklusiv Schirmhülle
 Doek vervaardigd uit in de massa gekleurd acrylaat van 300 gr/m²,
 beschermhoes inbegrepen
 Tessuto poliacrilico 300 gr/m² tinto in pasta, telo di protezione incluso
 Acrílico 300 gr/m² solución tintada, funda incluida

Stainless steel crown rings, pulleys and fittings
 Colliers de couronnes, poulies et visserie en acier inoxydable
 Kronenringe, Flaschenzüge und Beschläge aus Edelstahl
 Kroonringen, katrollen en beslag in roestvrij staal
 Anelli di mozzo, carrucole e accessori in acciaio inossidabile
 Aro de corona, polea y accesorios en acero inoxidable

"A-grade" teak ribs and hub, easily exchangeable
 Baleines et couronne en "A-grade" teck, facilement échangeables
 Schirmstreben und Schirmkrone aus erstklassigem Teakholz, leicht austauschbar
 Ribben en kroon in "A-grade" teakhout, makkelijk te vervangen
 Stecche e mozzo in legno teak di "grado A", facilmente intercambiabili
 Corona y brazos en madera de teca "grado A", facilmente recambiables

Ø 60 mm teak pole
 Mât de Ø 60 mm en teck
 Ø 60 mm Teakmast
 Ø 60 mm teakmast
 Palo in teak Ø 60 mm
 Mastil en teca Ø 60 mm

SHADY UMBRELLA WITH STAINLESS STEEL POLE AND TEAK RIBS

0,20 m² - BASE NOT INCLUDED

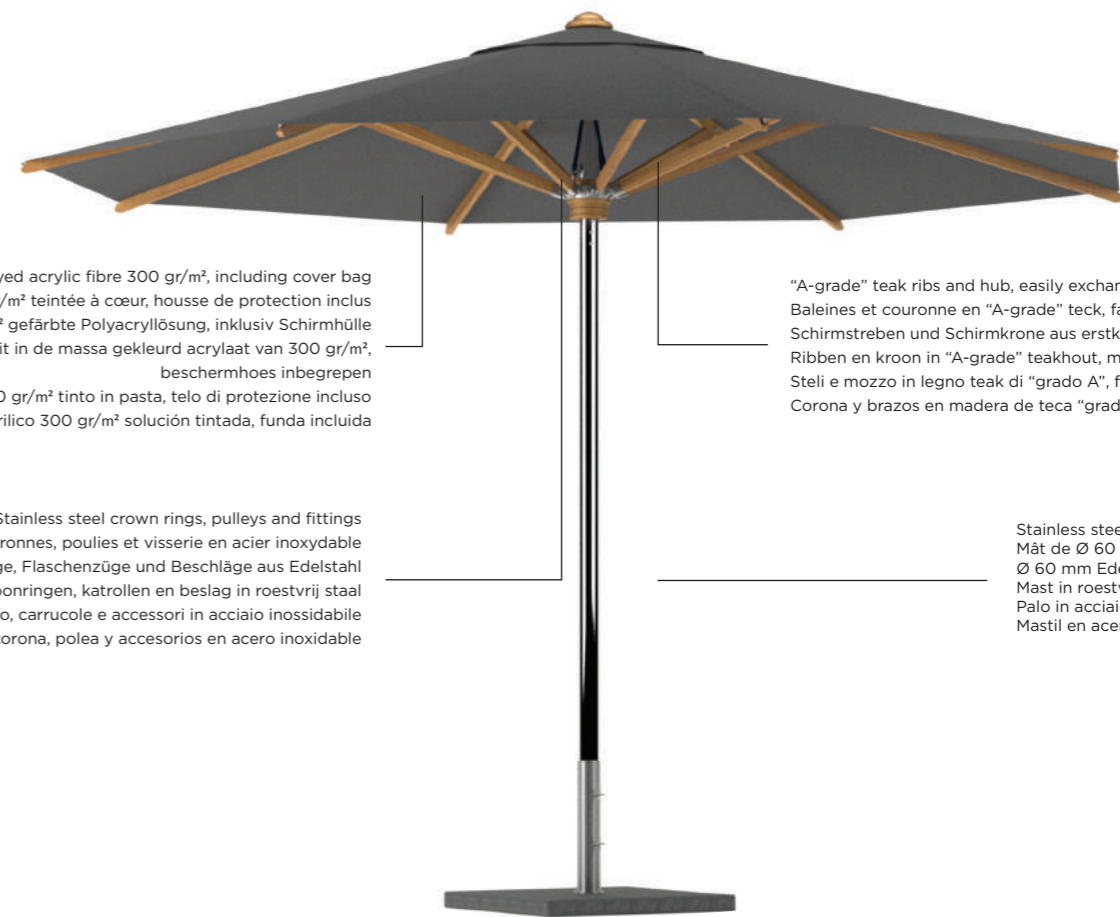

Cover solution dyed acrylic fibre 300 gr/m², including cover bag
 Toile en fibre acrylique 300 gr/m² teintée à cœur, housse de protection inclus
 Bespannung aus 300 gr/m² gefärbte Polyacryllösung, inklusiv Schirmhülle
 Doek vervaardigd uit in de massa gekleurd acrylaat van 300 gr/m²,
 beschermhoes inbegrepen
 Tessuto poliacrilico 300 gr/m² tinto in pasta, telo di protezione incluso
 Acrílico 300 gr/m² solución tintada, funda incluida

Stainless steel crown rings, pulleys and fittings
 Colliers de couronnes, poulies et visserie en acier inoxydable
 Kronenringe, Flaschenzüge und Beschläge aus Edelstahl
 Kroonringen, katrollen en beslag in roestvrij staal
 Anelli di mozzo, carrucole e accessori in acciaio inossidabile
 Aro de corona, polea y accesorios en acero inoxidable

"A-grade" teak ribs and hub, easily exchangeable
 Baleines et couronne en "A-grade" teck, facilement échangeables
 Schirmstreben und Schirmkrone aus erstklassigem Teakholz, leicht austauschbar
 Ribben en kroon in "A-grade" teakhout, makkelijk te vervangen
 Steli e mozzo in legno teak di "grado A", facilmente intercambiabili
 Corona y brazos en madera de teca "grado A", facilmente recambiables

Stainless steel pole Ø 60 mm
 Mât de Ø 60 mm en acier inoxydable
 Ø 60 mm Edelstahlmast
 Mast in roestvrij staal Ø 60 mm
 Palo in acciaio inossidabile Ø 60 mm
 Mastil en acero inoxidable Ø 60 mm

PP 34 - 35, 126 - 127



	TEAK POLE	TEAK RIBS	SIZE	A
	TK	TK	SHA 35 TK ...*	Ø 3,5 85 / 33"
	TK	TK	SHA 45 TK ...*	Ø 4,5 34 / 13"
	TK	TK	SHA 30V TK ...*	3,0 x 3,0 56 / 22"
	TK	TK	SHA 35V TK ...*	3,5 x 3,5 12 / 5"
	TK	TK	SHA 40R TK ...*	3 x 4 10 / 4"

* COVER COLOURS TEXTILE

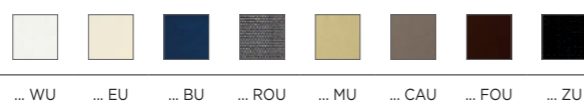

268 / 106"

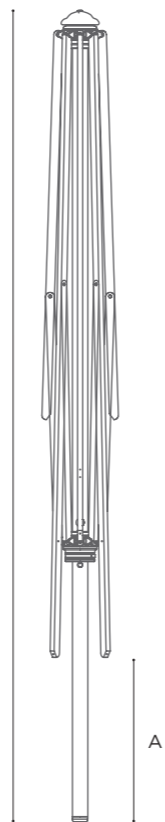

A



	STAINLESS STEEL POLE + TEAK RIBS	EP STAINLESS STEEL POLE + TEAK RIBS	SIZE	A
	TK	TK	SHA 35 ...* SHA 35 EP ...*	Ø 3,5 85 / 33"
	TK	TK	SHA 45 ...* SHA 45 EP ...*	Ø 4,5 34 / 13"
	TK	TK	SHA 30V ...* SHA 30V EP ...*	3,0 x 3,0 56 / 22"
	TK	TK	SHA 35V ...* SHA 35V EP ...*	3,5 x 3,5 12 / 5"
	TK	TK	SHA 40R ...* SHA 40R EP ...*	3 x 4 10 / 4"

* COVER COLOURS TEXTILE

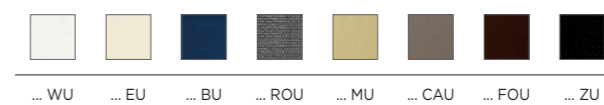

268 / 106"

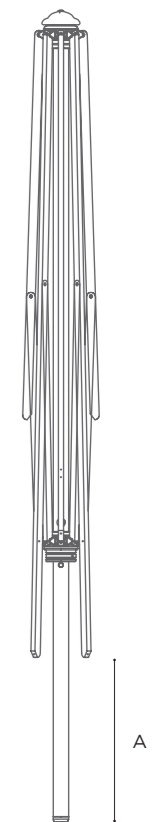

A

SHADY UMBRELLA WITH STAINLESS STEEL POLE AND COATED ALUMINIUM RIBS

0,20 m² - BASE NOT INCLUDED



Aluminium coated ribs, easily exchangeable
 Baleines en aluminium laqué, facilement échangeables
 Schirmstreben aus lackiertem Aluminium, leicht austauschbar
 Ribben uit gelakt aluminium, makkelijk te vervangen
 Stecche in alluminio rivestito, facilmente intercambiabili
 Brazos en aluminio revestido, facilmente recambiables

Cover solution dyed acrylic fibre 300 gr/m², including cover bag
 Toile en fibre acrylique 300 gr/m² teintée à cœur, housse de protection inclus
 Bespannung aus 300 gr/m² gefärbter Polyacryllösung, inklusiv Schirmhülle
 Doek vervaardigd uit in de massa gekleurd acrylaat van 300 gr/m², beschermhoes inbegrepen
 Tessuto poliacrilico 300 gr/m² tinto in pasta, telo di protezione incluso
 Acrilico 300 gr/m² solución tintada, funda incluida

Stainless steel crown rings, pulleys and fittings
 Colliers de couronnes, poulies et visserie en acier inoxydable
 Kronenringe, Flaschenzüge und Beschläge aus Edelstahl
 Kroonringen, katrollen en beslag in roestvrij staal
 Anelli di mozzo, carrucole e accessori in acciaio inossidabile
 Aro de corona, polea y accesorios en acero inoxidable

Stainless steel pole Ø 60 mm
 Mât de Ø 60 mm en acier inoxydable
 Ø 60 mm Edelstahlmast
 Mast in roestvrij staal Ø 60 mm
 Palo in acciaio inossidabile Ø 60 mm
 Mastil en acero inoxidable Ø 60 mm

Hub in coated teak
 Couronne en teck laqué
 Schirmkronen aus lackiertem Teak
 Kroon in gelakt teakhout
 Mozzi in legno teak rivestito
 Corona en madera de teca revestida

BRUSHED POLE + COATED ALU RIBS

EP POLE + COATED ALU RIBS

	BRUSHED POLE + COATED ALU RIBS	EP POLE + COATED ALU RIBS
Ø 3,5	SHA 35 ...*	SHA 35 EP ...*
Ø 4,5	SHA 45 ...*	SHA 45 EP ...*
3,0 x 3,0	SHA 30V ...*	SHA 30V EP ...*
3,5 x 3,5	SHA 35V ...*	SHA 35V EP ...*
3 x 4	SHA 40R ...*	SHA 40R EP ...*
Ø 3,5	SHA 35 T ...**	SHA 35 EPT ...**
Ø 4,5	SHA 45 T ...**	SHA 45 EPT ...**
3,0 x 3,0	SHA 30V T ...**	SHA 30V EPT ...**
3,5 x 3,5	SHA 35V T ...**	SHA 35V EPT ...**
3 x 4	SHA 40R T ...**	SHA 40R EPT ...**



SIZE	A	SIZE	Weight
Ø 3,5	85 / 33"	Ø 3,5	24,8 KG
Ø 4,5	34 / 13"	Ø 4,5	30,7 KG
3,0 x 3,0	56 / 22"	3,0 x 3,0	25,9 KG
3,5 x 3,5	12 / 5"	3,5 x 3,5	24,5 KG
3 x 4	10 / 4"	3 x 4	29,6 KG

* COVER COLOURS TEXTILE					
COVER	RIBS	COVER	RIBS	COVER	RIBS
[White]	ALU W	[Brown]	ALU C	[Black]	ALU A
*W		*C		*B	
** COVER COLOURS BATYLINE					
COVER	RIBS	COVER	RIBS	COVER	RIBS
[White]	ALU W	[Brown]	ALU C	[Black]	ALU A
**W		**C		**B	



268 / 106"

SHADY UMBRELLA WITH COATED ALUMINIUM POLE AND COATED ALUMINIUM RIBS

0,20 m² - BASE NOT INCLUDED



Aluminium coated ribs, easily exchangeable
 Baleines en aluminium laqué, facilement échangeables
 Schirmstreben aus lackiertem Aluminium, leicht austauschbar
 Ribben uit gelakt aluminium, makkelijk te vervangen
 Stecche in alluminio rivestito, facilmente intercambiabili
 Brazos en aluminio revestido, facilmente recambiables

Cover solution dyed acrylic fibre 300 gr/m², including cover bag
 Toile en fibre acrylique 300 gr/m² teintée à cœur, housse de protection inclus
 Bespannung aus 300 gr/m² gefärbter Polyacryllösung, inklusiv Schirmhülle
 Doek vervaardigd uit in de massa gekleurd acrylaat van 300 gr/m², beschermhoes inbegrepen
 Tessuto poliacrilico 300 gr/m² tinto in pasta, telo di protezione incluso
 Acrilico 300 gr/m² solución tintada, funda incluida

Stainless steel crown rings, pulleys and fittings
 Colliers de couronnes, poulies et visserie en acier inoxydable
 Kronenringe, Flaschenzüge und Beschläge aus Edelstahl
 Kroonringen, katrollen en beslag in roestvrij staal
 Anelli di mozzo, carrucole e accessori in acciaio inossidabile
 Aro de corona, polea y accesorios en acero inoxidable

Coated aluminium pole Ø 60 mm
 Mât de Ø 60 mm en aluminium lacqué
 Ø 60 mm aus lackiertem Aluminium
 Ø 60 mm gelakt aluminium
 Palo in alluminio rivestito Ø 60 mm
 Mastil en aluminio revestido Ø 60 mm

Hub in coated teak
 Couronne en teck laqué
 Schirmkronen aus lackiertem Teak
 Kroon in gelakt teakhout
 Mozzi in legno teak rivestito
 Corona en madera de teca revestida

COATED ALU POLE

COATED ALU RIBS

	COATED ALU POLE	COATED ALU RIBS
Ø 3,5	SHA 35 EP ...*	
Ø 4,5	SHA 45 EP ...*	
3,0 x 3,0	SHA 30V EP ...*	
3,5 x 3,5	SHA 35V EP ...*	
3 x 4	SHA 40R EP ...*	
Ø 3,5	SHA 35 EPT ...**	
Ø 4,5	SHA 45 EPT ...**	
3,0 x 3,0	SHA 30V EPT ...**	
3,5 x 3,5	SHA 35V EPT ...**	
3 x 4	SHA 40R EPT ...**	



SIZE	A	SIZE	Weight
Ø 3,5	85 / 33"	Ø 3,5	24,9 Kg
Ø 4,5	34 / 13"	Ø 4,5	30,7 Kg
3,0 x 3,0	56 / 22"	3,0 x 3,0	25,8 Kg
3,5 x 3,5	12 / 5"	3,5 x 3,5	24,4 Kg
3 x 4	10 / 4"	3 x 4	29,4 Kg

* COVER COLOURS TEXTILE					
COVER	RIBS & POLE	COVER	RIBS & POLE	COVER	RIBS & POLE
[White]	ALU W	[Brown]	ALU C	[Black]	ALU A
*WW		*CC		*BB	
** COVER COLOURS BATYLINE					
COVER	RIBS & POLE	COVER	RIBS & POLE	COVER	RIBS & POLE
[White]	ALU W	[Brown]	ALU C	[Black]	ALU A
**WW		**CC		**BB	

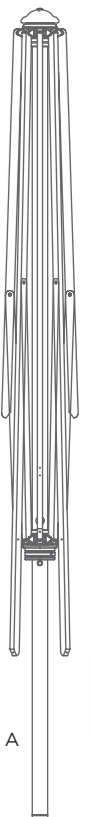

268 / 106"

SHADY X-CENTRIC UMBRELLA WITH STAINLESS STEEL POLE AND TEAK RIBS

0,20 m³ - STANDARD WITH GRANITE BASE - OPTIONAL MOBILE BASE - ref: MOB X

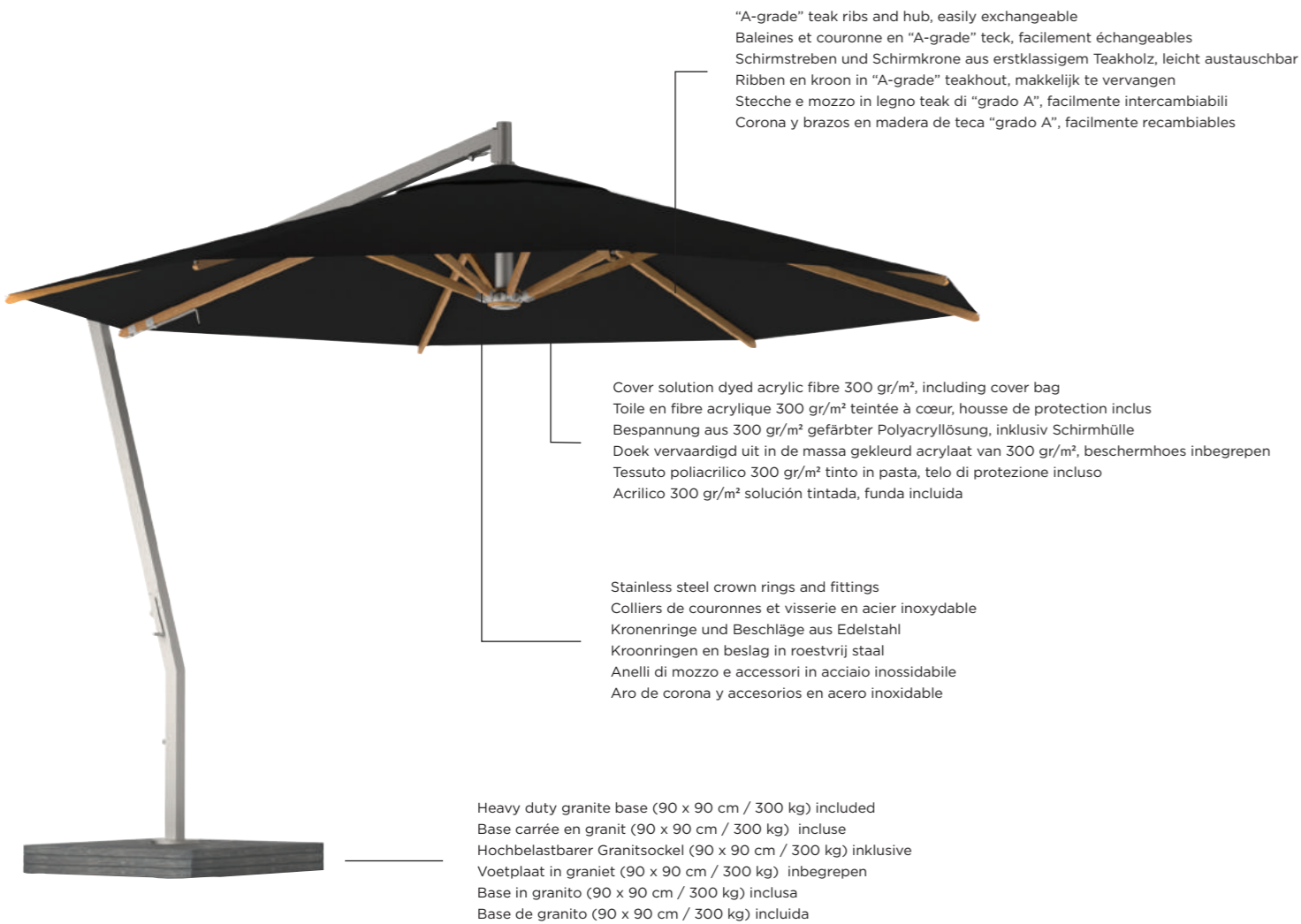

	STAINLESS STEEL POLE + TEAK RIBS	EP STAINLESS STEEL POLE + TEAK RIBS	SIZE	Weight
TEXTILE	SHAX 40 ...*	SHAX 40 EP ...*	Ø 4,0	28,0 Kg
	SHAX 40R ...*	SHAX 40R EP ...*	3 x 4	31,0 Kg

* COVER COLOURS TEXTILE

... WU	... EU	... BU	... ROU	... MU	... CAU	... FOU	... ZU
--------	--------	--------	---------	--------	---------	---------	--------

SHADY X-CENTRIC UMBRELLA WITH STAINLESS STEEL POLE AND COATED ALUMINIUM RIBS

0,20 m³ - STANDARD WITH GRANITE BASE - OPTIONAL MOBILE BASE - ref: MOB X

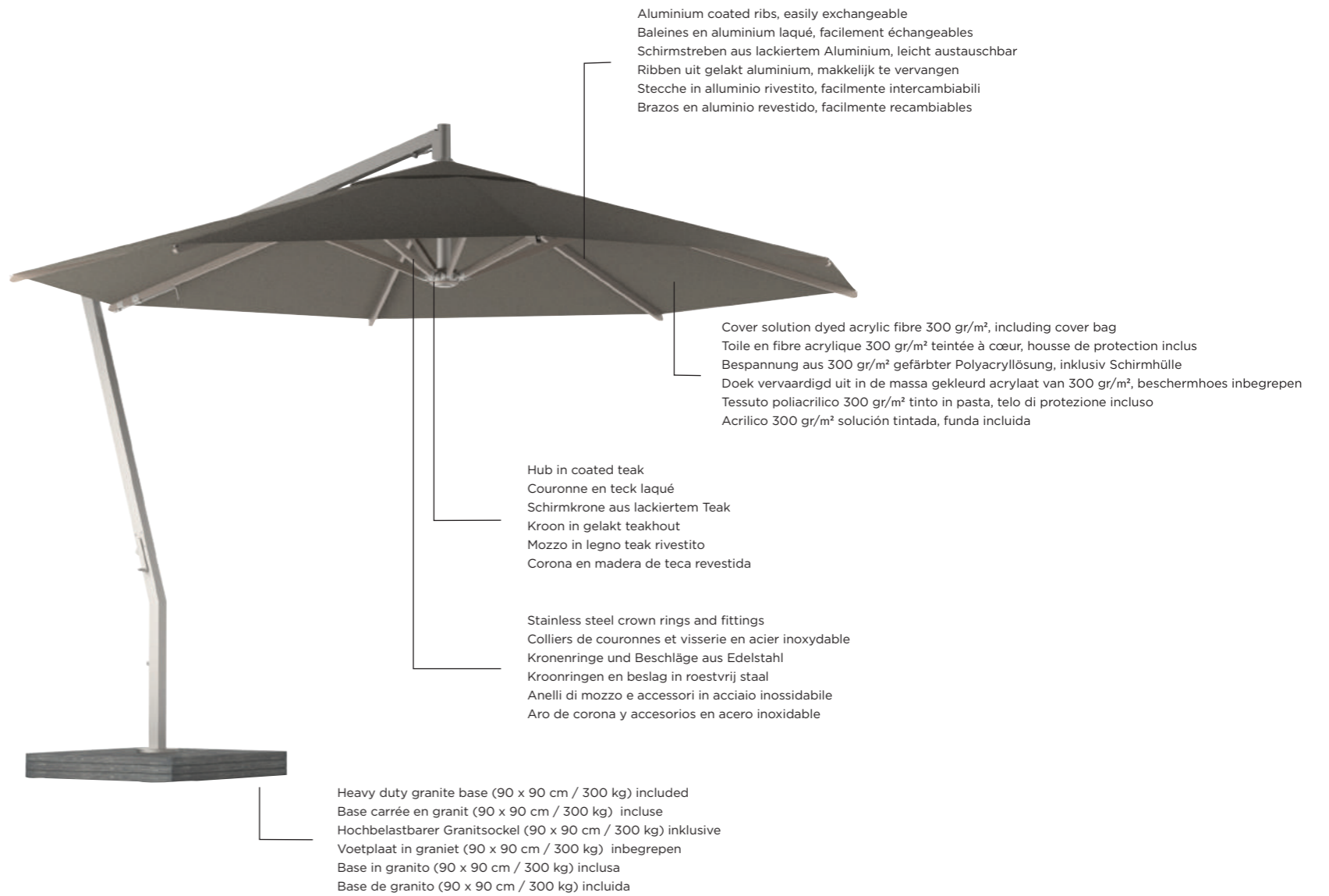

	COATED ALU. + STAINLES STEEL	COATED ALU. + EP STAINLES STEEL	COATED ALU. + STAINLES STEEL	COATED ALU. + EP STAINLES STEEL	COATED ALU. + STAINLES STEEL	COATED ALU. + EP STAINLES STEEL
TEXTILE	SHAX 40 WW	SHAX 40 EPWW	SHAX 40 CC	SHAX 40 EPCC	SHAX 40 BB	SHAX 40 EPBB
	SHAX 40R WW	SHAX 40R EPWW	SHAX 40R CC	SHAX 40R EPCC	SHAX 40R BB	SHAX 40R EPBB
BATYLINE	SHAX 40 TWW	SHAX 40 EPTWW	SHAX 40 TCC	SHAX 40 EPTCC	SHAX 40 TBB	SHAX 40 EPTBB
	SHAX 40R TWW	SHAX 40R EPTWW	SHAX 40R TCC	SHAX 40R EPTCC	SHAX 40R TBB	SHAX 40R EPTBB

UMBRELLA BASES

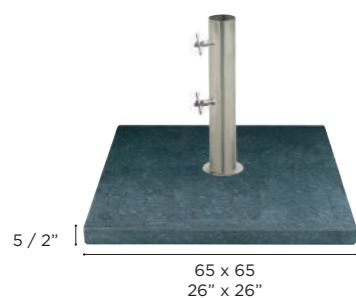

CEY V 70 BP: •

- Black granite
- Granit Noir
- Schwarzer Granit
- Zwart graniet
- Granito nero
- Granito negro



CEY T 65 IP: •
CEY T 65 IPEP: •

- Polished stainless steel tube
- Tube en acier inoxydable poli
- Schirm-Hülse aus gebürsteten Edelstahl
- Buis in geslepen roestvrij staal
- Tubo in acciaio inox spazzolato
- Tubo en acero inoxidable pulido

Ø 65
Ø 65
Ø 65
Ø 65
Ø 65
Ø 65

54 kg / 119 Lbs

CEY V 70 RG: •

- Black granite
- Granit Noir
- Schwarzer Granit
- Zwart graniet
- Granito nero
- Granito negro



CEY T 65 IP: •
CEY T 65 IPEP: •

- Polished stainless steel tube
- Tube en acier inoxydable poli
- Schirm-Hülse aus gebürsteten Edelstahl
- Buis in geslepen roestvrij staal
- Tubo in acciaio inox spazzolato
- Tubo en acero inoxidable pulido

Ø 65
Ø 65
Ø 65
Ø 65
Ø 65
Ø 65

43 kg / 95 Lbs

CEY V 70 IP: •
CEY V 70 IPEP: •

- Polished stainless steel
- Acier inoxydable poli
- Gebürsteter Edelstahl
- Geslepen roestvrij staal
- Acciaio inox spazzolato
- Acero inoxidable pulido



CEY T 65 IP: •
CEY T 65 IPEP: •

- Polished stainless steel tube
- Tube en acier inoxydable poli
- Schirm-Hülse aus gebürsteten Edelstahl
- Buis in geslepen roestvrij staal
- Tubo in acciaio inox spazzolato
- Tubo en acero inoxidable pulido

34 kg / 75 Lbs

CEY V W: •

- Stainless steel - for CEY V 70 IP
- Inoxydable poli - pour CEY V 70 IP
- Edelstahl - für CEY V 70 IP
- Roestvrij staal - voor CEY V 70 IP
- Acciaio inox - per CEY V 70 IP
- Acero inoxidable - para CEY V 70 IP



CEY V X EP: •

- Polished stainless steel - for CEY V 70 BP & CEY V 70 G
- Acier inoxydable poli - pour CEY V 70 BP & CEY V 70 G
- Gebürsteter Edelstahl - für CEY V 70 BP & CEY V 70 G
- Geslepen roestvrij staal - voor CEY V 70 BP & CEY V 70 G
- Acciaio inox spazzolato - per CEY V 70 BP & CEY V 70 G
- Acero inoxidable pulido - para CEY V 70 BP & CEY V 70 G



CEY T 65 IPL: •
CEY T 65 IPLEP: •

- Long polished stainless steel tube - for OZN 130 HLS & OZN 160 HLS
- Tube long en acier inoxydable poli - pour OZN 130 HLS & OZN 160 HLS
- Lange Schirm - Hülse aus gebürsteten Edelstahl - für OZN 130 HLS & OZN 160 HLS
- Lange buis in geslepen roestvrij staal - voor OZN 130 HLS & OZN 160 HLS
- Tubo lungo in acciaio inox spazzolato - per OZN 130 HLS & OZN 160 HLS
- Tubo lungo en acero inoxidable pulido - para OZN 130 HLS & OZN 160 HLS



MOBY

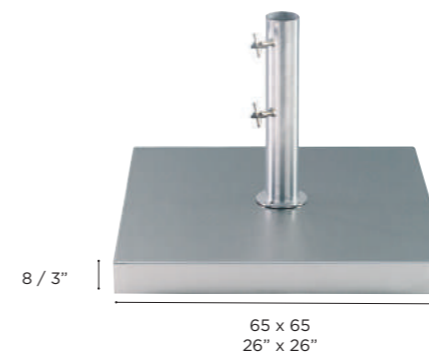

MOB 65: •
MOB 65 EP: •

FEATURES

- Brushed stainless steel body
- Nylon wheels and detachable handle for moving around on the terrace
- To be filled with gravel for added weight
- Polished stainless steel tube included

CARACTERISTIQUES

- Socle et tube en acier inoxydable poli
- Roulettes en nylon dur et manivelle démontable, facilitant le déplacement
- A remplir avec gravier pour augmenter le poids
- Tube en acier inoxydable poli inclus

SPEZIFIKATIONEN

- Korpus aus gebürstetem Edelstahl
- Nylonbereifung und ein abnehmbarer Griff für die freie Beweglichkeit
- Wird mit Kies befüllt, um das Gewicht zu erhöhen
- Hülse aus gebürsteten Edelstahl inklusiv



23 kg / 50,7 Lbs + balast

KENMERKEN

- Behuizing geslepen roestvrij staal
- Nylon wielen en afneembaar handvat voor een eenvoudige verplaatsing
- Te vullen met kiezel voor extra gewicht
- Buis in geslepen roestvrij staal inbegrepen

CARATTERISTICHE

- Corpo in acciaio inox
- Ruote in nylon staccabili manualmente per facili spostamenti
- Essere riempito con ghiaia per aggiungere peso
- Tubo in acciaio inox spazzolato incluso

CARACTERISTICAS

- Cuerpo en acero inoxidable pulido
- Ruedas de Nylon y mango desmontable para mover por la terraza
- Para rellenarse con grava para pesa adicional
- Tubo en acero inoxidable pulido incluido

MOBY X-CENTRIC (ONLY FOR USE WITH SHADY X-CENTRIC)



MOB X:
•
MOB X EP:
•



MOB X W:
•



MOB X C:
•



MOB X B:
•

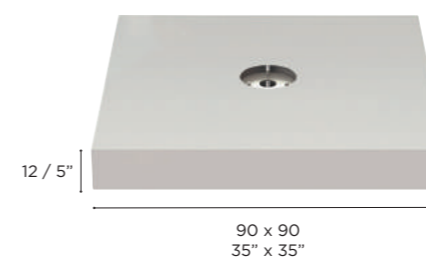

188 kg / 415 Lbs

PRICE SUPPLEMENT ON UMBRELLA PRICE
SUPPLEMENT DE PRIX AU PRIX DU PARASOL
MEHRPREIS AUF SCHIRMPREISE
PRIJSSUPPLEMENT OP DE PRIJS VAN DE PARASOL

SUPPLEMENTO DI PREZZO SUL PREZZO DELL' OMBRELLONE
SUPLEMENTO EN EL PRECIO DE LA SOMBRILLA

FEATURES

- Stainless steel or coated aluminium cover
- Nylon wheels and detachable handle for moving around on the terrace
- Concrete weights included

CARACTERISTIQUES

- Couverture en acier inoxydable ou aluminium coloré
- Roulettes en nylon dur et manivelle démontable, facilitant le déplacement
- Poids en béton inclus

SPEZIFIKATIONEN

- Kappe aus Edelstahl oder aluminium
- Nylonbereifung und ein abnehmbarer Griff für die freie Beweglichkeit
- Inklusiv Betonteilen

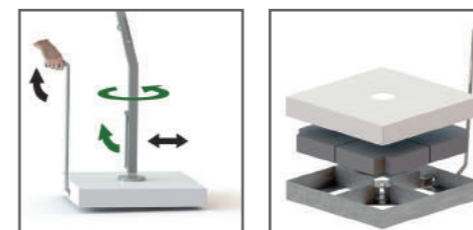

KENMERKEN

- Afdekkap uit roestvrij staal of gelakt aluminium
- Nylon wielen en afneembaar handvat voor een eenvoudige verplaatsing
- Betonelementen inbegrepen

CARATTERISTICHE

- Copercio in acciaio inox o alluminio
- Ruote in nylon staccabili manualmente per facili spostamenti
- Peso in calcestruzzo incluso

CARACTERISTICAS

- Copertura en acero inoxidable y aluminio recubiertos
- Ruedas de Nylon y mango desmontable para mover por la terraza
- Peso en hormigón incluida

MAINTENANCE

TEAK / TECK / TEAKHOLZ / TEAK / TEAK / TECA

TEAK CLEANER

REF: TEAC - 500ML: •

- POWERFUL CLEANER: for removal of all stains and dirt on teakwood
- NETTOYANT PUISSANT: pour le traitement des taches et toutes les salissures sur le teck
- KRAFTVOLLER REINIGER: zur Beseitigung von Flecken und allen Verunreinigungen auf Teakholz
- KRACHTIGE REINIGER: voor de behandeling van vlekken en alle soorten bevuilding op teakhout
- POTENTE LIMPIADOR: para eliminar manchas y suciedad en madera de teca
- POTENTE DETERGENTE: per la rimozione di tutte le macchie e della sporcizia dal teak



TEAK SEALER

REF: TEAS - 500ML: •

- Long-term protection against weathering and graying
- Protection contre décoloration et grisaillement
- Beinhaltet Teakfarbe, schützt langanhaltend gegen silbergraue Patina
- Langdurige bescherming tegen verwerking en vergrijzen
- Protección de larga duración contra el desgaste y la pérdida de color
- Protezione a lungo termine dagli agenti atmosferici e dall'ingrigimento



TEAK RENOVATOR

REF: TEAR - 500ML: •

- Restoration of discoloured teak
- Renover le teck décoloré
- Restoriert graues Teakholz
- Hernieuwen van vergrijsd teak
- Renovador de la teca desgastada
- Rinnovo il teak grigio



TEAK PROTECTOR

Ref: TEAPR - 500ml: •

- TEAK PROTECTOR: Protects against moisture and dirt
- PROTECTEUR POUR TECK: Protège contre l'humidité et les salissures
- TEAKSCHUTZMITTEL: Schutz gegen Wasser und Verschmutzung
- TEAK BESCHERMER: Voorkomt vocht-en vuilindringing
- TRATTAMENTO DI PROTEZIONE PER TEAK: Protegge dall'umidità e dalla sporcizia
- PROTETTORE PER TEAK: Protegge da umidità e sporco



NO STAIN

REF: NST - 500ML: •

- No stain
- Anti-tache
- Fleckstop
- Vlekstop
- Anti-Manchas
- Senza macchia



STAINLESS STEEL / ACIER INOXYDABLE / EDELSTAHL ROESTVAST STAAL / ACCIAIO INOSSIDABILE / ACERO INOXIDABLE

STAINLESS STEEL CLEANER

REF: SSC - 500ML: •

- Stainless steel cleaner
- Nettoyant pour acier inoxydable
- Edelstahlreiniger
- Inox reinigingsmiddel
- Limpiador de acero inoxidable
- Detergente per acciaio inox



STAINLESS STEEL HEAVY DUTY CLEANER

REF: SSHC - 500ML: •

- Stainless steel polish
- Polish inox
- Edelhstahlpolitur
- Roestvrij staal polish
- Pulidor de acero inoxidable
- Lucidante per acciaio inossidabile



STAINLESS STEEL PROTECTOR

REF: SSP - 500ML: •

- Stainless steel protector / renewer: Cleans & protects
- Protecteur / renovateur inox: Nettoie & protège
- Edelstahlschutz: Reinigt, schützt & erneuert
- Roestvrij staalbeschermer / vernieuwer: Reinigt & beschermt
- Agente protettivo / rinnovatore acciaio inox: Pulisce & protegge
- Protector / renovador de acero inoxidable: Limpia & protege



BATYLINE® & FIBRE CLEANER

BATYLINE® & FIBRE CLEANER

REF: BFC - 500ML: •

- Batyline® & Coaxxs® cleaner
- Nettoyant Batyline® et Coaxxs®
- Batyline® und Coaxxs® Reiniger
- Batyline® en Coaxxs® reiniger
- Limpiador para Batyline® & Coaxxs®
- Limpiador Batyline® & Coaxxs®



You can find more information about our maintenance products in our maintenance catalogue.
 Vous pouvez trouver plus d'informations sur nos produits d'entretien dans notre catalogue d'entretien.
 Mehr Informationen zu unseren Pflegeprodukten finden Sie in unserem Pflegekatalog.
 Meer informatie betreffende onze onderhoudsproducten kan u vinden in onze onderhoudscatalogus.
 Potete trovare ulteriori informazioni circa i nostri prodotti sul nostro catalogo manutenzione.
 Puede encontrar más información sobre nuestros productos para mantenimiento en nuestro catálogo de mantenimiento.

ACRYLIC FABRICS - CATEGORY A

WHITE BASIC
REF: WU CAT.: A



ECRU BASIC
REF: EU CAT.: A



MOCCA BASIC
REF: MU CAT.: A

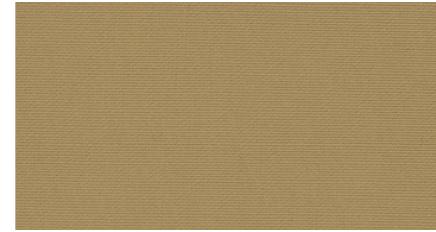

CAPPUCCINO BASIC
REF: CAU CAT.: A

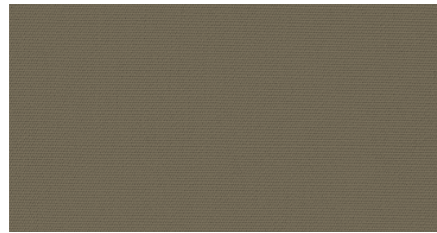

BLACK BASIC
REF: ZU CAT.: A



ROCK BASIC
REF: ROU CAT.: A



CHOCOLAT BASIC
REF: CHU CAT.: A



AQUA BASIC
REF: AQU CAT.: A



RED BASIC
REF: RU CAT.: A

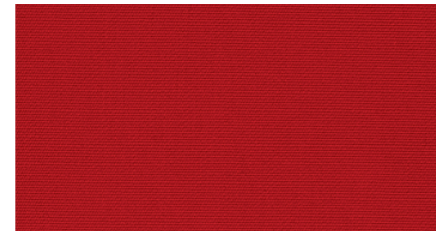

As only the best is good enough, all Royal Botania textiles are woven of 100% solution-dyed acrylic fibre; your guarantee for optimal water -and UV resistance, and of course many years of premium comfort. **Tous nos tissus Royal Botania sont 100% fibre acrylic et teints dans la masse: votre garantie pour une résistance aux UV et à l'eau et bien sûr plusieurs années d'un confort optimum.** Da nur das Beste gut genug ist, werden alle Royal Botania-Stoffe aus 100% düsengefärbten Acrylfasern hergestellt. Mit diesen erstklassigen Stoffen können wir Ihnen den bestmöglichen Feuchtigkeits- und UV-Schutz garantieren **Gezien enkel het beste goed genoeg is, zijn alle Royal Botania stoffen geweven uit in de massa gekleurde acrylaat vezel; uw zekerheid voor optimale water - en UV resistentie en tevens voor vele jaren optimaal comfort.** Così come solo il meglio è buono abbastanza, tutti i tessuti Royal Botania sono prodotti con fibra 100% acrilica tinta in pasta, la Vostra garanzia per una resistenza all'acqua ed ai raggi UV ottimale e, naturalmente, per molti anni di massimo comfort. **Visto que sólo el mejor es suficiente, todas las telas han tejido en 100% fibra acrílica teñida en masa; resiste a la decoloración del agua y del sol, y también una garantía para un confort óptimo.**

ACRYLIC FABRICS - CATEGORY B

FEATHER FLAX
REF: FF CAT.: B



DESERT STONE FLAX
REF: DSF CAT.: B

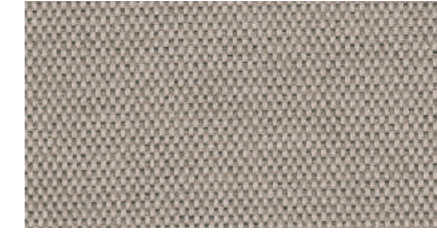

STONE FLAX
REF: SF CAT.: B

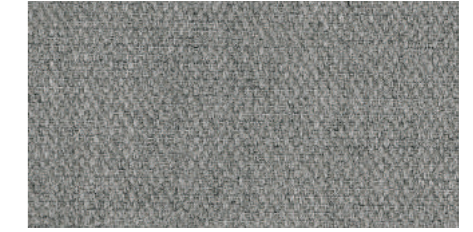

FROST LINEN
REF: FL CAT.: B



GREY SAND CHEVRON
REF: GSC CAT.: B



MARBLE FLAX
REF: MAF CAT.: B



PLUM FLAX
REF: PF CAT.: B



AQUA FLAX
REF: AQF CAT.: B

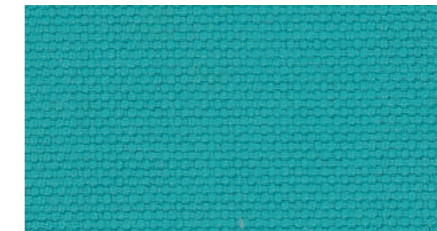

BEACH FLAX
REF: BF CAT.: B

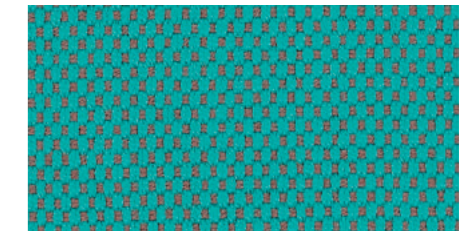

ELECTRIC BLUE FLAX
REF: EBF CAT.: B

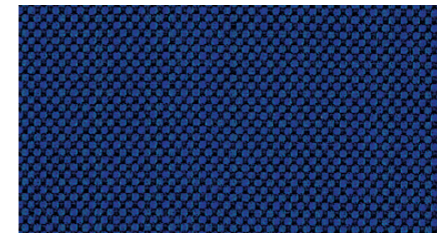

NAVY BLUE FLAX
REF: NBF CAT.: B

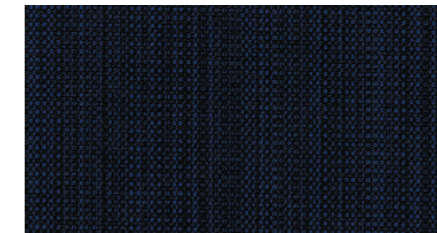

ORANGE FLAX
REF: OF CAT.: B

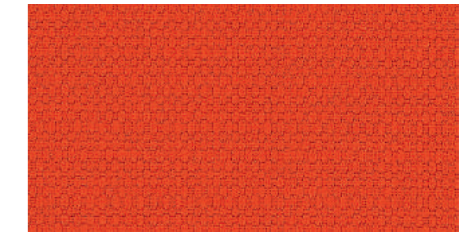

SPRING PUFF
REF: SP CAT.: B

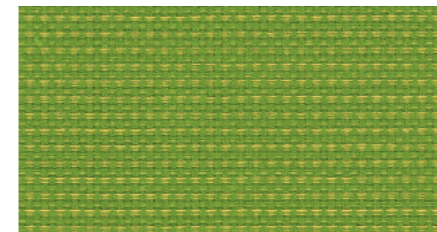

KAKI PUFF
REF: KP CAT.: B

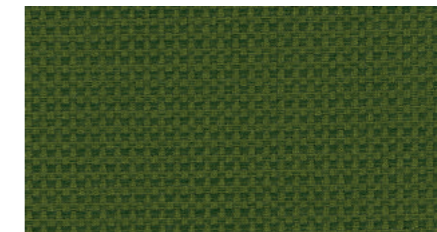

POLYPROPYLENE FABRICS | CATEGORY B

CHEVRON WHITE
REF: NCW CAT.: B



CHEVRON WHITE LINEN
REF: NCWL CAT.: B

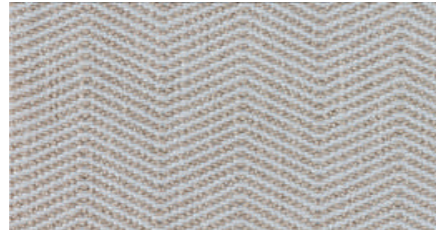

WHITE DOT
REF: NWD CAT.: B



LINEN DOT
REF: NLD CAT.: B



GREY DOT
REF: NGD CAT.: B

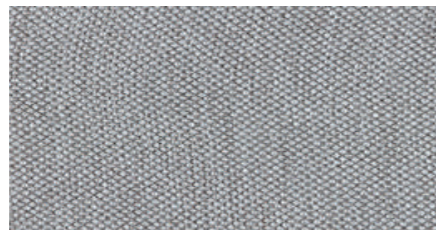

NATURAL SILVER DOT
REF: NSD CAT.: B

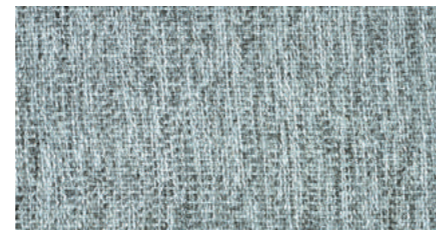

NATURAL FONDANT DOT
REF: NFD CAT.: B

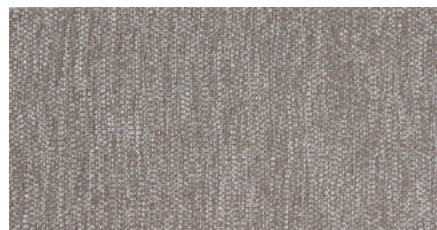

LATE SPRING GREY
REF: LSG CAT.: B



LATE SPRING UNI
REF: LSU CAT.: B



AQUA DOT
REF: NAD CAT.: B

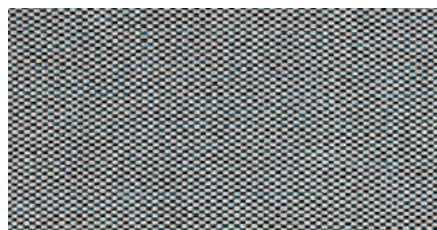

AQUA TWIN
REF: NAT CAT.: B

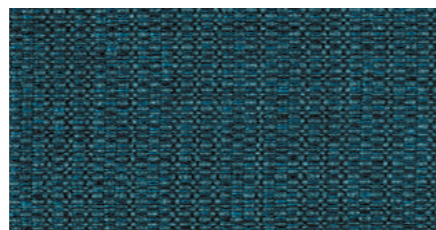

AQUA GREY TWIN
REF: NAGT CAT.: B

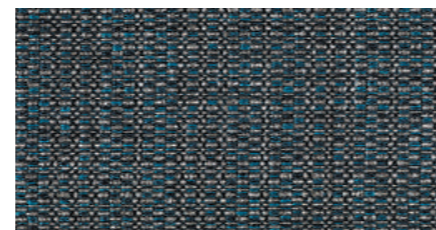

CHARCOAL STRIPE
REF: NCS CAT.: B

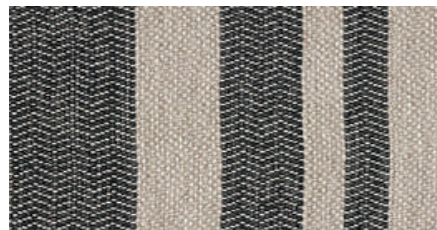

CHARCOAL TWIN
REF: NCT CAT.: B

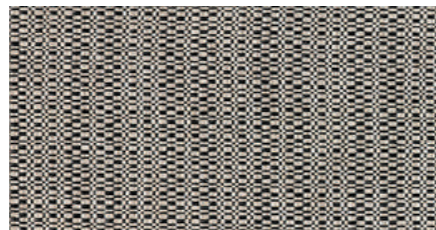

CHARCOAL DOT
REF: NCD CAT.: B

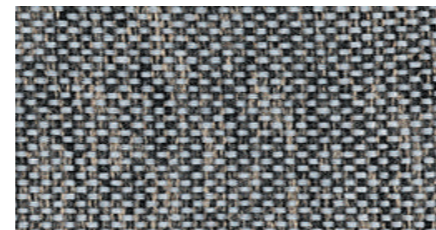

MOSS STRIPE
REF: NMS CAT.: B

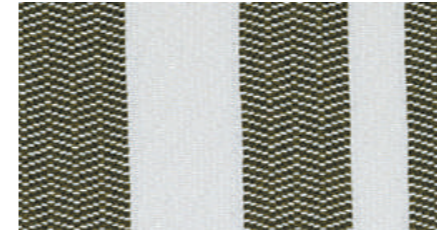

MOSS WHITE DOT
REF: NMWD CAT.: B

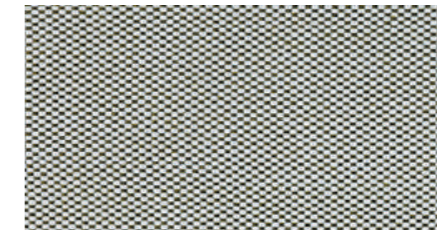

MOSS LINEN DOT
REF: NMLD CAT.: B

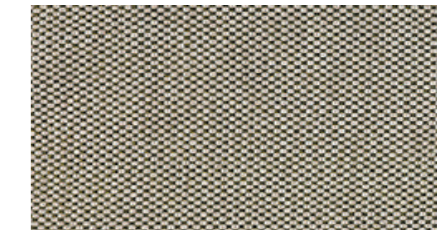

BRICK STRIPE
REF: NBS CAT.: B



BRICK DOT
REF: NBD CAT.: B

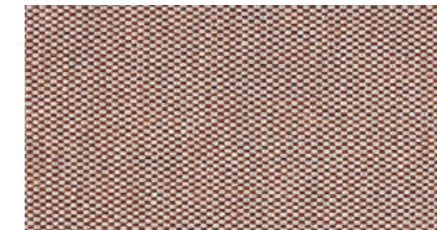

BRICK CHEVRON
REF: NBC CAT.: B

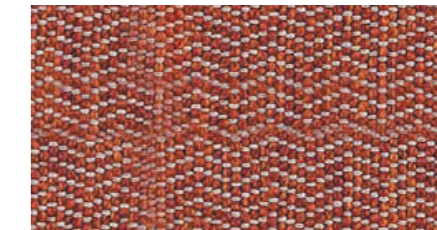

LAMINATED FABRICS FOR LOUNGE COLLECTIONS ONLY

TUXEDO LINEN LAMINATED
REF: TULL CAT.: B

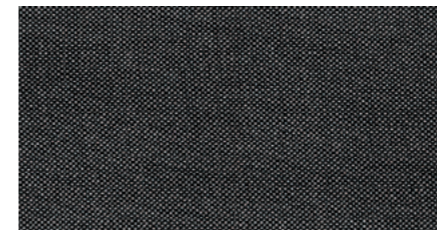

FROST LINEN LAMINATED
REF: FLL CAT.: B

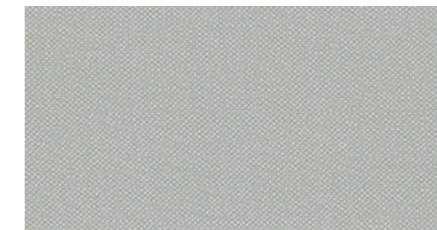

MARBLE FLAX LAMINATED
REF: MAFL CAT.: B

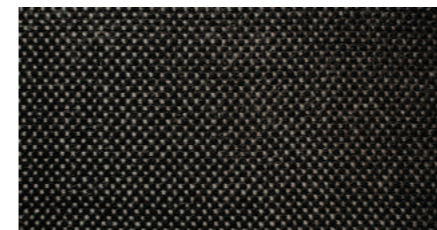

DESERT STONE FLAX LAMINATED
REF: DSFL CAT.: B

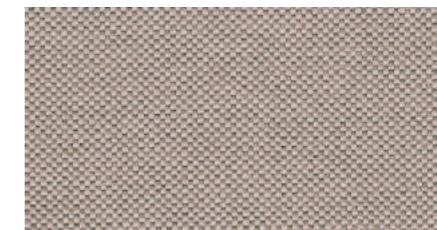

100% solution-dyed acrylic. A woven fibre protected by a waterproof PVC layer on the inside. 100% fibre acrylique teinte dans la masse. La fibre est rendue imperméable grâce à une membrane PVC étanche placée à l'intérieur. 100% aus düsengefärbtem Acrylfaser. Ein Gewebe das auf der Rückseite mit einer wasserdichten PVC-Membran beschichtet ist. 100% in de massa gekleurde vezel. Een stof bekleed aan de rugzijde met een waterdicht PVC membraan. 100% fibra acrilica tinta in pasta. Una fibra resa impermeabile da un rivestimento interno in PVC. 100% fibra acrilica teñida en masa. La fibra se dota de un recubrimiento de PVC que garantiza una excepcional resistencia a las condiciones meteorológicas.

100% polypropylene. Water and oil repellent. 100% polypropylène. Oléofuge et hydrofuge. 100% Polypropylen. Wasser- und ölabweisend. 100% polypropyleen. Water en olie afstotend. 100% polipropilene. Resistente all'acqua e all'olio. 100% polipropileno. Repelente de agua y aceite.

DECORATIVE CUSHIONS

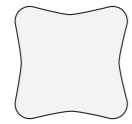

40 x 40 CM
15" x 15"

PIL 40 MRS: • (CAT. A)
PIL 40 MRS: • (CAT. B)

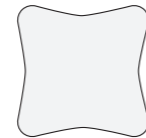

45 x 45 CM
17" x 17"

PIL 45 MRS: • (CAT. A)
PIL 45 MRS: • (CAT. B)



50 x 30 CM
19" x 11"

PIL 53 MRS: • (CAT. A)
PIL 53 MRS: • (CAT. B)



60 x 40 CM
23" x 15"

PIL 64 MRS: • (CAT. A)
PIL 64 MRS: • (CAT. B)

WINTER COVERS

Royal Botania offers tailor made winter covers.
Royal Botania propose des housses de protection.
Royal Botania bietet maßgeschneiderte Abdeckungen für den Winter.
Royal Botania biedt op maat gemaakte wintercovers.
Royal Botania ofrece fundas de invierno hechas a medida.
Royal Botania offre coperture invernali realizzate su misura.



CHAIR COVER

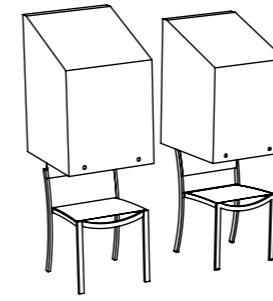

REF: ODC ... + COVER: •
ITEM REF.

example: OZN47

ARMCHAIR COVER

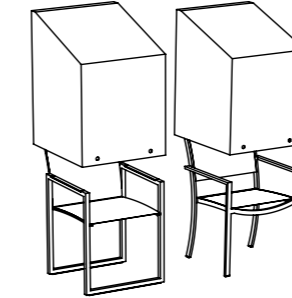

REF: ODC ... + COVER: •
ITEM REF.

example: OZN55

LOUNGER COVER

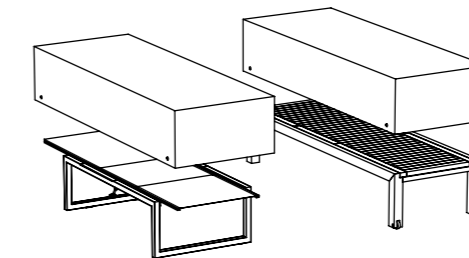

REF: ODC ... + COVER: •
ITEM REF.

example: OZN195

RELAX CHAIR COVER

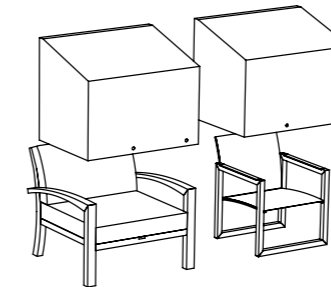

REF: ODC ... + COVER: •
ITEM REF.

example: NNX77

LOUNGE COVER (TAILOR MADE)

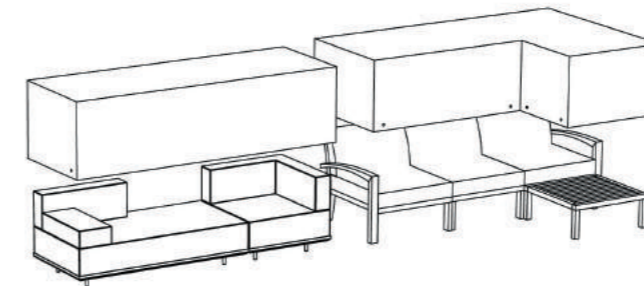

REF: ODC ... + COVER: • /element ±80cm
(ITEMS)

For every order
a clear sketch of your
combination is required

TABLE COVERS (TAILOR MADE) - PRICE ON DEMAND

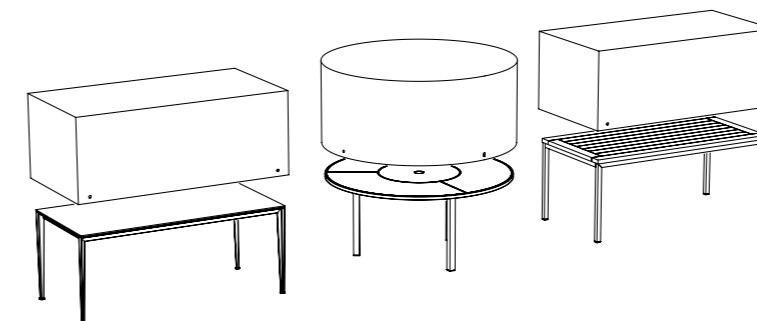

REF: ODC ... + COVER: price on demand
ITEM REF.

100% polyester EVA coated waterproof fabric, weight: 200gr/m² color: CAU

BATYLINE

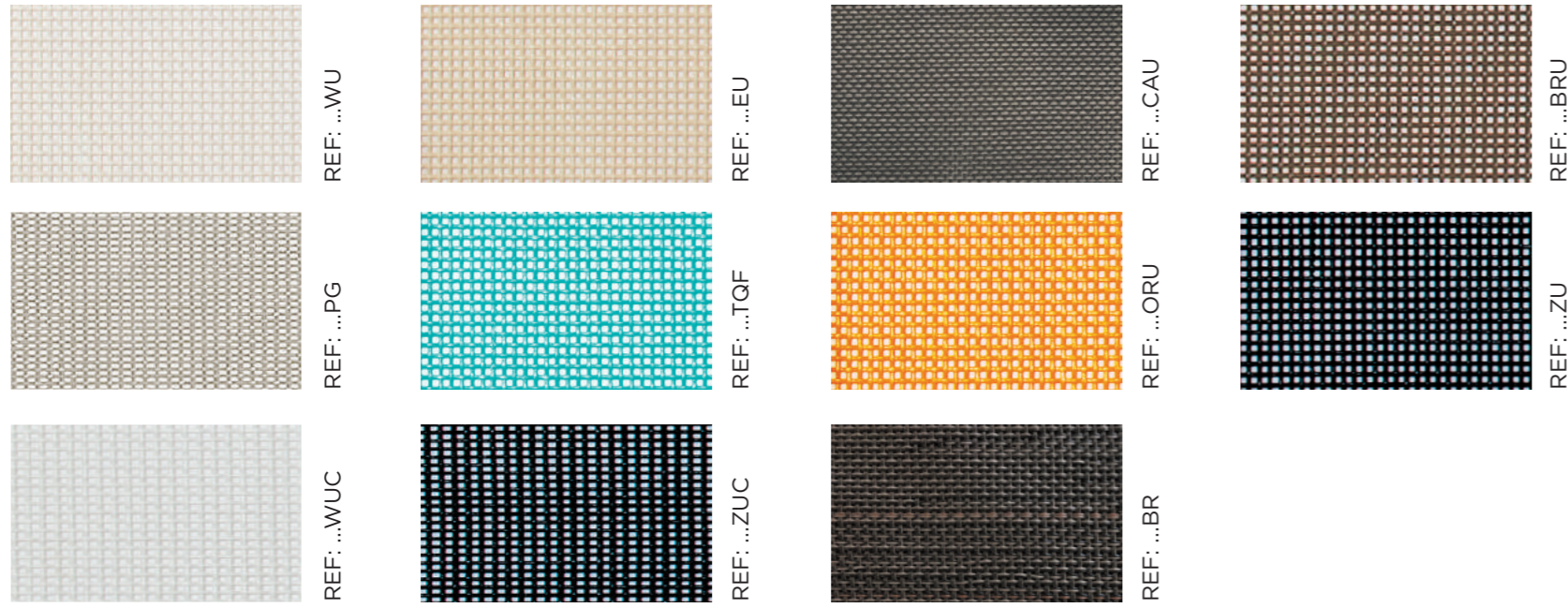

The slings on metal framed chairs and loungers are made of Batyline® fabrics, a woven polyester fibre protected by a PVC coating. This coating guarantees exceptional resistance to climatic conditions and UV exposure. The fact that there is no moisture absorption results in quick-drying action, little sensitivity to staining, and simplicity in cleaning. Les toiles des sièges et chaises longues en métal sont réalisées en Batyline®, une fibre de polyester recouverte d'un revêtement en PVC et tissée. Le revêtement synthétique est garant d'une résistance exceptionnelle aux UV et aux conditions climatiques. Vu qu'elle n'absorbe nullement l'humidité, cette matière sèche rapidement, se tache difficilement et est facile à nettoyer. Stühle, Sessel und Liegen mit Metallgestell sind mit Batyline-Gewebe, einer gewobenen Polyesterfasen mit PCV-Beschichtung, Gespannt. Die Kunststoffbeschichtung garantiert eine extreme Wetter- und UV-Beständigkeit. Das hat zur Folge, dass das Gewebe schnell trocknet, unempfindlich auf Flecken reagiert und einfach zu reinigen ist. Voor de zit- en rugbespanning van onze stoelen en ligbedden maken wij gebruik van Batyline® weefsel, een polyestervezel die wordt voorzien van een PVC-coating en vervolgens geweven. De kunststof coating staat garant voor een uitzonderlijke weer- en UV bestendigheid. Het feit dat geen vocht wordt opgenomen resulteert in een snelle droging, geringe vlekgevoeligheid, en eenvoudige reiniging. I teli delle poltrone e dei lettini con strutture in metallo sono realizzati in tessuto batyline®, una fibra di poliestere rivestita di PVC e tessuta. Il rivestimento sintetico è garante di una resistenza eccezionale agli UV e alle condizioni climatiche. Dato che non assorbe l'umidità, questo materiale si asciuga rapidamente, si macchia difficilmente ed è facile da pulire. Para el asiento y la espalda de nuestras sillas utilizamos batyline® tejido, una fibra de poliéster se dota de un recubrimiento de PVC antes de tejerse. El recubrimiento sintético garantiza una excepcional resistencia a las condiciones meteorológicas y a los rayos UV. El que no absorba humedad, hace que se seque rápido, sea muy poco sensible a las manchas y se limpie fácilmente.

OLEFIN FIBRE

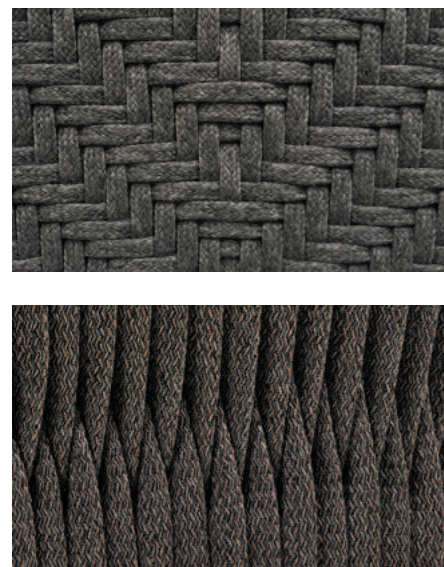

(For JIVE & TWIST collection only)

Olefin fibre is a synthetic fibre made from polyethylene. The advantage of this fibre is its strength, colour fastness and comfort. Also it is very resistant to staining and different weather conditions. La fibre d'oléfine est une fibre synthétique faite à partir de polyéthylène. Ses avantages sont sa force, résistance des couleurs et son confort. Elle est également très résistante aux taches et aux différentes conditions météorologiques. Olefin-Faser ist eine synthetische Faser aus Polyethylen. Vorteile dieser Faser sind Widerstandsfähigkeit, Farbbeständigkeit und Komfort. Zudem ist Olefin fleckenabweisend und wetterbeständig. De olefin vezel is een synthetische vezel van polyethylen. De voordelen van deze krachtige vezel zijn het comfort en de kleurvastheid. Daarnaast is deze vezel ook zeer goed bestand tegen vlekken en verschillende weersomstandigheden. La fibra Olefin è una fibra sintetica a base di polietilene. I pregi di questa fibra sono la sua resistenza, la stabilità del colore e il comfort. È inoltre molto resistente alle macchie e alle diverse condizioni atmosferiche. La fibra de olefina es una fibra sintética hecha de polietileno. La ventaja de esta fibra es su fuerza, solidez del color y comodidad. También es muy resistente a manchas y a las diferentes condiciones climáticas.

CERAMIC

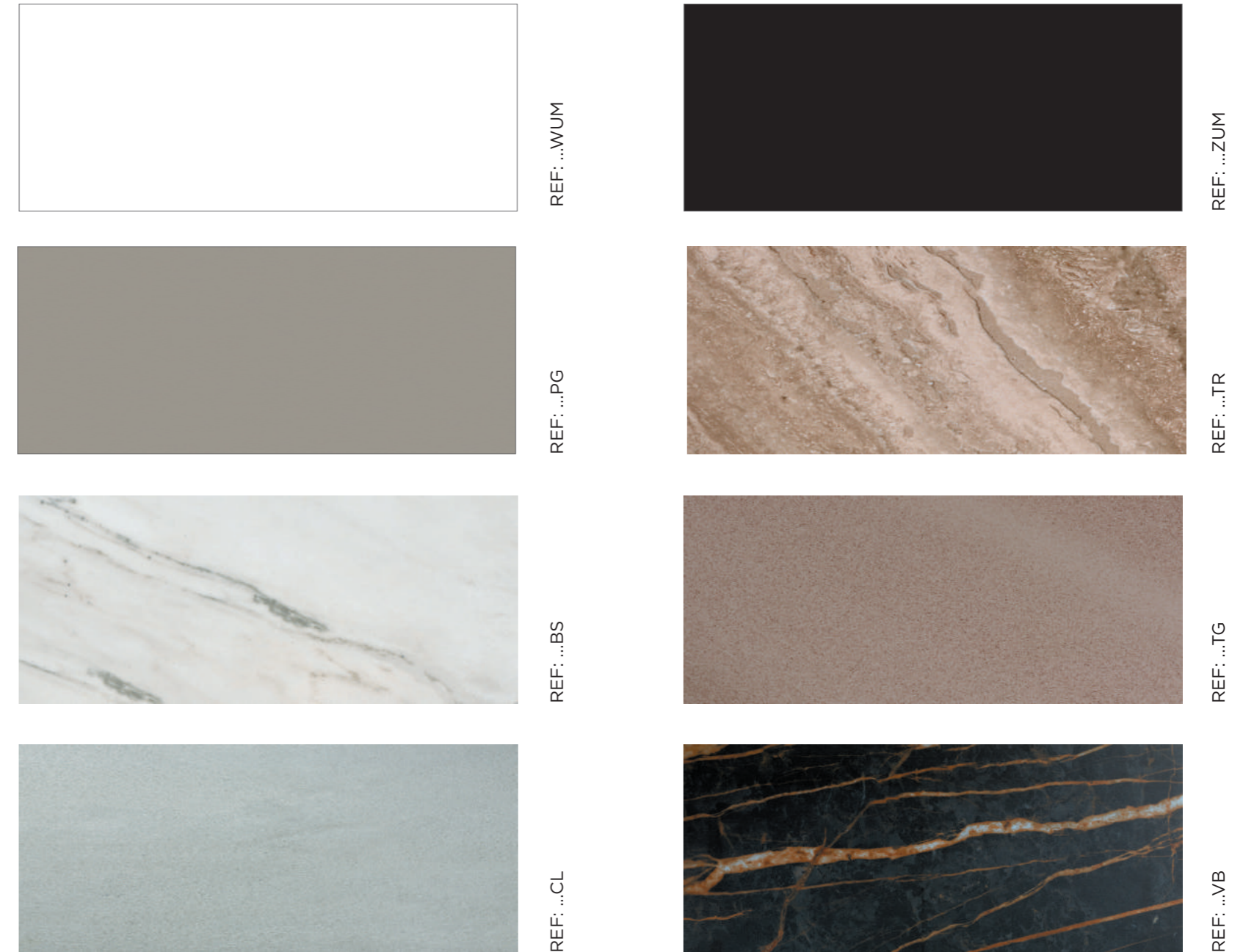

The table tops are made from natural material which means small color gradations can occur. This is typical to ceramic which makes each table unique. Les plateaux sont faits d'un matériau naturel et donc des petites différences de couleur peuvent se produire. Cela est inhérent à la céramique et fait chaque tableau unique. Die Tischplatten sind aus einem natürlichen Material produziert, wodurch leichte Farbunterschiede auftreten können. Das ist eigen an dem Material Keramik und macht jeden Tisch zu einem einzigartigen Produkt. De bovenbladen worden vervaardigd uit een natuurlijk materiaal waardoor kleine kleurverschillen kunnen optreden. Dit is eigen aan het materiaal keramiek en maakt elk tafel uniek. I piani dei tavoli sono prodotti con materiali naturali quindi ci potrebbero essere delle piccole differenze di colore. E' una caratteristica tipica della ceramica e rende ogni tavolo un pezzo unico. Los tableros están fabricados de un material natural, lo que significa que puede haber pequeñas diferencias de color. Esto es propio de la cerámica y hace que cada tablero sea único.

STAINLESS STEEL

Stainless steel is a ferrous alloy with increased corrosion resistance due to the addition of chrome and nickel. Chlorine the greatest enemy of RFS and can cause a type of corrosion known as “pitting”. For this reason, it is recommended that in coastal locations the metal be given as smooth a surface as possible in order to further increase its resistance to corrosion. The furniture frames of the Wave and QT collections are supplied with an electropolished finish as standard. For the Ninix and O-Zon ranges we recommend the optional electro-polishing treatment of the frame if it is to be used in a corrosive environment. **L’acier inoxydable est mieux connu sous le nom d’inox. Il s’agit d’un alliage de fer dont la résistance à la corrosion est accrue par ajout de chrome et de nickel. Le chlore est le principal ennemi de l’inox et peut provoquer une corrosion par piqûres ou perforante. C’est la raison pour laquelle à proximité de la côte (le sel marin est en effet du chlorure de sodium), il est conseillé de polir au maximum la surface du métal afin d’augmenter encore la résistance à la corrosion. Les cadres des meubles des collections WAVE et QT subissent une electropolissage. Pour les gammes NINIX et O-ZON pour tout usage en milieu corrosif, nous conseillons l’electropolissage du cadre du meuble, proposé en option. Rostfreier Stahl auch als Edelstahl bekannt, besteht aus einer Eisenlegierung, bei der die Korrosionsbeständigkeit erhöht wurde durch die Hinzufügung von Chrom und Nickel. Chlor ist der größte Feind des Edelstahls und kann Korrosion in Form von Vertiefungen, bekannt als ‚pitting‘ verursachen. Darum ist es in Küstennahe angewiesen, um das Metall eine so glatt wie mögliche Oberfläche zu geben, um die Korrosionsbeständigkeit noch weiter zu verbessern. Die Gestelle der Kollektionen Wave und QT sind immer elektroliert. Für die Kollektion Ninix und O-Zon raten wir deshalb an, um die Möbel in einem korrosiven Milieu extra elektrolytisch zu polieren. Roestvast staal is beter bekend als RVS of Inox. Het betreft een ijzerlegering, waarbij de corrosiebestendigheid verhoogd wordt door toevoeging van chroom en nikkel. Chloor is de grootste vijand van RVS en kan putvormige corrosie, gekend als “pitting” veroorzaken. Om die reden is het in de nabijheid van de kust aangewezen, het metaal een zo glad mogelijk oppervlak te geven, teneinde de corrosiebestendigheid nog verder op te voeren. De frames uit de collecties Wave en QT worden standaard geëlectropolijst. Voor de collecties ninix en O-Zon adviseren wij voor toepassing in een corrosief milieu het optioneel elektrolijsten van het meubelframe. L’acciaio inossidabile è una lega di ferro la cui resistenza alla corrosione è aumentata con l’aggiunta di cromo e nichel. Il cloro è il principale nemico dell’acciaio inox, e può causare una corrosione puntiforme, detta “pitting”. Per questo, in prossimità del mare, è raccomandabile che la superficie del metallo sia molto ben levigata, al fine di aumentare ulteriormente la sua resistenza alla corrosione. Le strutture delle collezioni Wave e QT sono fornite di serie con finitura elettrolitica. Per le collezioni Ninix e O-Zon raccomandiamo la finitura elettrolitica delle strutture, disponibile come opzione, nel caso di utilizzo dei mobili in ambienti considerati corrosivi. El acero inoxidable es una mezcla de hierro con mayor resistencia a la corrosión gracias a la composición del cromo y el níquel. El cloro, el mayor enemigo del RVS, puede causar una corrosión llamada “pitting”. Por ese motivo, en zonas costeras es recomendable dotar al metal de una de una superficie lo más lisa posible a fin de incrementar la resistencia a la corrosión. Los acabados de las colecciones WAVE y QT vienen de serie con un acabado electropulido. Para las colecciones NINIX, O-Zon y QT recomendamos un tratamiento electropulido opcional en el acabado si el mobiliario tiene que estar en un entorno corrosivo.**

TEAK

As Royal Botania never compromises on quality, only carefully selected mature teakwood is used in our products. All of it harvested in strict accordance with our environmental policies. Teak wood is produced by the Tectona Grandis and the wood’s renowned durability is due to its high content of natural oils. The limited absorption of moisture protects the wood from warping and gives it enormous stability. In addition, the wood is highly resistant to attacks by pests. It is because of these qualities, as well as its exceptionally attractive hue and structure, that teak is widely considered “the noblest of all wood types”. Soil and climate conditions have a significant impact on the quality of the wood, and as such, only the Indonesian plantation wood has the same superior qualities as wood harvested from the Golden Triangle: the Laos, Myanmar and Thailand region. Only wood that has fully matured possesses the much valued qualities of great stability and moisture resistance. Mature wood is ready to be felled after 75 to 80 years. Comme Royal Botania n’accepte jamais de compromis quand il s’agit de la qualité, seul le bois de teck mature, sélectionné avec soin, est utilisé, coupé dans le respect strict de nos mesures environnementales. Le bois est issu du Tectona Grandis, sa solidité universellement reconnue trouve son origine dans sa forte teneur en huiles naturelles. Vu que l’absorption d’eau est minime, le bois ne travaille pas beaucoup et est donc extrêmement stable. En outre, le bois offre une forte résistance aux agressions de produits chimiques ainsi qu’aux attaques des vermines. Ces qualités d’une part et sa couleur et sa structure exceptionnellement belles d’autre part en font le plus noble de tous les types de bois. Etant donné que la nature du sol et les conditions climatiques influencent fortement la qualité du bois, seul le bois indonésien du Tectona Grandis peut se vanter de posséder les mêmes qualités que le bois naturel, que celui en provenance du triangle d’or : Le Laos, Myanmar, la Thaïlande. Seul le bois adulte possède les qualités recherchées que sont la stabilité et la résistance. Le bois est bon pour l’abattage après 75 à 80 ans. Auf dem Gebiet von Qualität macht Royal Botania keine Kompromisse und verwendet nur sorgfältig ausgewähltes und ausgewachsenes Teak Holz, das nach strengen Milieunormen gefällt wird. Das Holz stammt von dem Tectona Grandis ab und hat seine Nachhaltigkeit zu danken an seinem großen Anteil an natürlichen Ölen. Dadurch ist die Feuchtigkeitsaufnahme eingeschränkt, was dafür sorgt, dass das Holz geringfügig arbeitet und eine enorme Stabilität aufweist. Außerdem hat das Holz eine große Resistenz gegen chemischen Einflüssen, als auch gegen Anfällen von Ungeziefer. Den Beinamen ‚die nobelste Holzsorte‘ hat das Teakholz seiner schönen Farbe, seiner Struktur und seinen nachhaltigen Qualitäten zu danken. Der Bodenzustand und die Klimamstände haben einen wichtigen Einfluss auf die Qualität des Holzes, deshalb kann nur das Indonesische Plantagenholz konkurrieren mit den Qualitäten des natürlichen Holzes, das aus dem ‚Golden Triangle‘ der Regionen Laos, Myanmar und Thailand stammt. Nur das ausgewachsene Holz besitzt diese berühmten Qualitäten was die Stabilität und Resistenz betrifft. Das Holz kann nach 75 bis 80 Jahren gefällt werden. Vermits Royal Botania geen toegevingen doet op gebied van kwaliteit gebruiken wij enkel zorgvuldig geselecteerd, volgroeid teakhout, dat geoogst wordt volgens strikte normen op gebied van milieubehoud. Het hout is afkomstig van de Tectona Grandis, de alom geprezen duurzaamheid van het hout vindt zijn oorsprong in het hoge gehalte aan natuurlijke oliën. De daaruit volgende geringe opname van vocht zorgt voor geringe werking, resulterend in een enorme stabiliteit. Bovendien biedt het hout een hoge resistentie tegen inwerking van chemicaliën, alsook tegen aantasting door ongedierte. Aan deze kwaliteiten en de uitzonderlijk mooie kleur en structuur dankt het de titel “de nobelste der houtsoorten”. Daar de bodemgesteldheid en de klimatologische omstandigheden een belangrijke invloed hebben op de kwaliteit van het hout, kan enkel het Indonesische plantagehout bogen op gelijke kwaliteiten als het natuurlijke hout dat vooral afkomstig is uit de Golden Triangle zijnde de regio van Laos, Myanmar en Thailand. Enkel het volwassen hout beschikt over de geprezen kwaliteiten qua stabiliteit en resistentie. Het hout is kaprijp na 75 à 80 jaar. Dato che Royal Botania non accetta compromessi sulla qualità, viene accuratamente selezionato solo legno di teak maturo di prima scelta, prelevato in stretta conformità con le nostre politiche ambientali. Il legno proviene dalla Tectona Grandis, e la sua rinomata durezza è dovuta al suo elevato contenuto di oli naturali. Il limitato assorbimento d’acqua di questo legno lo protegge dalla deformazione e gli conferisce un’enorme stabilità. Inoltre offre un’elevata resistenza agli attacchi di parassiti. In virtù di queste qualità, e grazie anche alla sua tonalità e alla struttura eccezionalmente attraenti, il teak è ampiamente considerato “il più nobile di tutti i tipi di legno”. La natura del suolo e le condizioni climatiche influenzano largamente la qualità del legno, così, solo il legno delle piantagioni indonesiane vanta le stesse qualità del legno raccolto nel Triangolo d’Oro: la regione del Laos, del Myanmar e della Thailandia. Solo il legno adulto possiede le qualità assai apprezzate di stabilità e resistenza all’umidità. Il legno maturo infatti è pronto per essere tagliato dopo 75/80 anni. En Royal Botania estamos comprometidos con la calidad, por ello sólo utilizamos teca madurada cuidadosamente seleccionada en nuestros productos. Todo ello siguiendo estrictamente nuestras políticas ambientales. La madera de teca, originaria del Tectona Grandis, destaca por su durabilidad gracias a un alto contenido en aceites naturales, lo que limita la humedad protegiendo la madera de la deformación y dotándola de una gran estabilidad. Además, es altamente resistente al efecto de sustancias químicas y a los daños ocasionados por plagas. Gracias a estas cualidades y a su excepcional color y estructura, la teca es considerada la más noble de las maderas. Dado que la condición del suelo y las circunstancias climatológicas tienen una importante influencia en la calidad de la madera, sólo las plantaciones de madera indonesia tienen las mismas cualidades óptimas que las que se encuentran en el Triángulo Dorado: Laos, Myanmar y Tailandia. La madera madura está lista para ser talada de los 75 a los 80 años, momento en el que posee las valiosas cualidades de estabilidad y resistencia a la humedad.

OUTDOOR LIGHTING



ASK YOUR DEALER FOR THE COMPLETE ROYAL BOTANIA
OUTDOOR LIGHTING CATALOG

WWW.ROYALBOTANIA.COM



1011 SPIKY 1021 Q-BIC
1031 BEACON 1041
TESLA 1051 BULLET
1061 GLOW
1071 PARKER





1011



1021



1031



1121



1131



1141



1041



1051

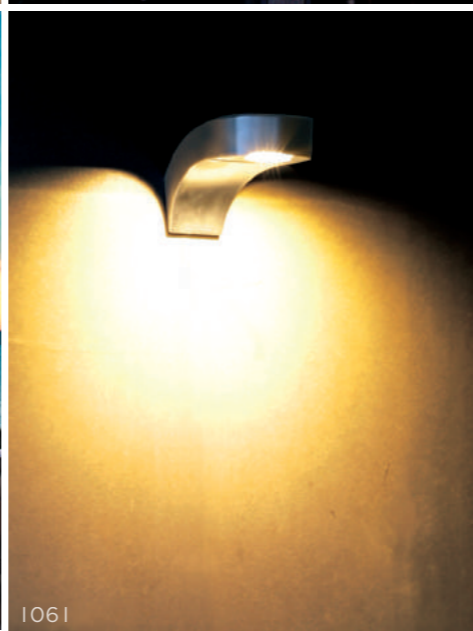

1061



1151



1161



1171



1071



1081

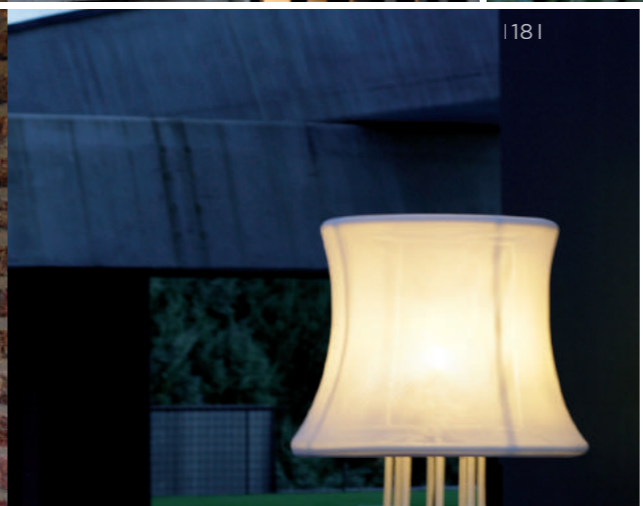

1181



- 1011 PRATO 1021 LOG
- 1031 Q-BIC 1041 DOME
- 1051 CLUB 1061 COBRA
- 1071 RUSTY 1081 OMEGA
- 1091 BEAMY 1101 SPIKY LOUNGE
- 1111 ELLIPSE 1121 DOME
- 1131 LOG 1141 TWIN
- 1151 DOME 1161 Q-BIC
- 1171 NORTHPOLE 1181 3D
- 1191 DOME 1201 DOME

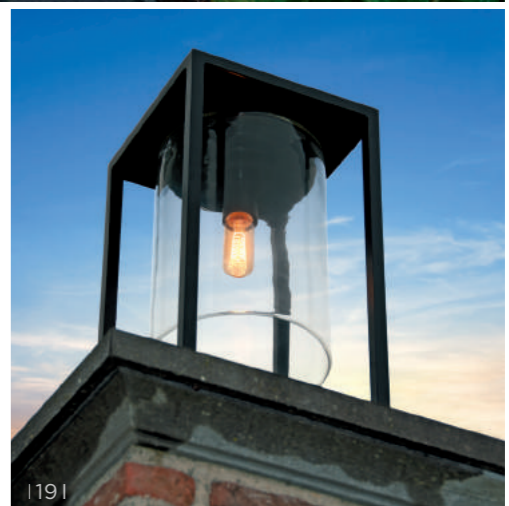

1191



1091

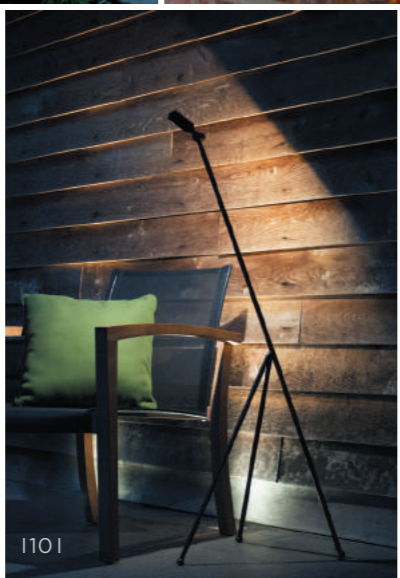

1101



1111



1201

PROJECTS



FOR A SELECTION OF HOTELS AND RESTAURANTS FURNISHED WITH ROYAL BOTANIA OUTDOOR PRODUCTS, PLEASE REFER TO

WWW.ROYALBOTANIA.COM

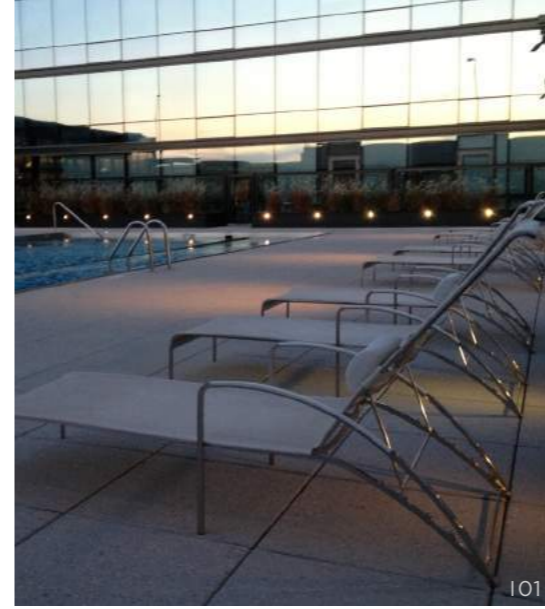

1011 CONDO, CHICAGO
 1021 MIRAMONTI HOTEL, ITALY
 1031 THERMES MARINS MONTE-CARLO
 1041 SCHWARZER ADLER, KITZBÜHEL, AUSTRIA
 1051 HOTEL W, SINGAPORE



1011



1061



1071



1021



1031



1081

1011 CARLTON HOTEL SANKT MORITZ, SWITZERLAND
1021 OCEAN EMERALD SUPER YACHT 1031 GRAND HOTEL KEMPINSKI, GENEVA 1041 TSEUNG KWAN O AREA 56, HONG KONG 1051 MIRAMONTI HOTEL, ITALY 1061 HET ROODE KOPER, THE NETHERLANDS 1071 LES THERMES MARINS, MONACO 1081 HET ROODE KOPER, THE NETHERLANDS 1091 HOTEL W, SINGAPORE 1101 HOTEL RIBERACH, PERPIGNAN



1041



1051



1091

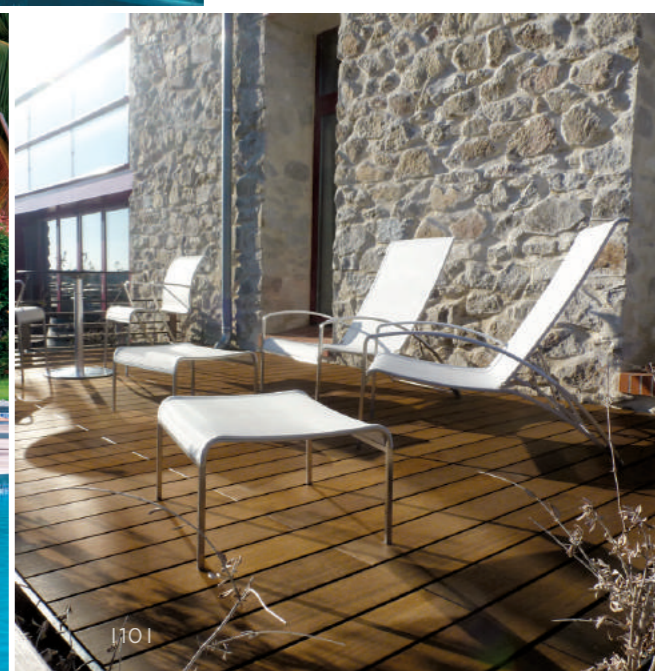

1101

OUTDOOR LUXURY OUTDOOR LIGHTING

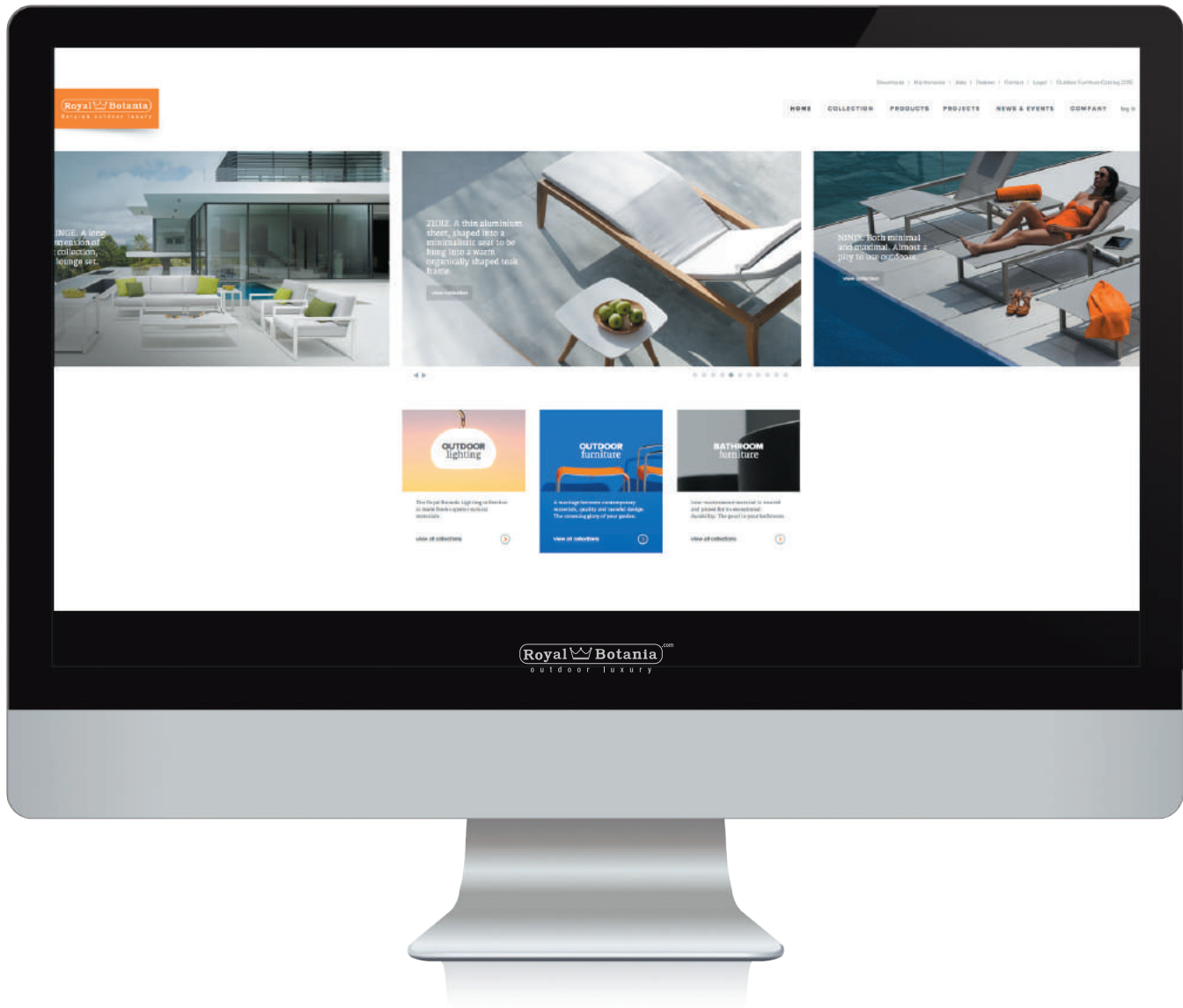

WWW.ROYALBOTANIA.COM

