



TABLE OF CONTENTS

Centerfire Pistols	
Security-9®	3-6
Ruger American® Pistol	7-10
SR1911®	11-14
EC9s®	17
LC380CA™	17-18
LCP®/ LCP® II	19-20
Rimfire Pistols	
SR22®	21-24
Mark IV™	25-32
Silent-SR® .22 LR	33-36
22 Charger™	71-72
Double-Action Revolvers	
Ruger SP101®	39-42
GP100®	43-46
Redhawk®	47-48
Super Redhawk®	49-50
LCR®	51-56
Single-Action Revolvers	
New Vaquero	59-60
New Model Super Blackhawk®	61-62
New Model Blackhawk®	63-64
New Model Single-Six®	65-68
New Bearcat®	69-70

Autoloading Rifles	
10/22®	73-80
Silent-SR® ISB	81-84
PC Carbine™	85-88
AR-556®	89-96
Mini-14® and Mini Thirty®	97-102
Bolt-Action Rifles	
Ruger Precision® Rifle	103-106
Ruger Precision® Rimfire	107-110
Ruger American® Rifle	111-118
Ruger American® Rimfire	119-124
Ruger® Scout Rifle	125-128
Ruger® Guide Gun	129-132
Hawkeye®	133-140
77-Series Rifles	141-144
Single-Shot Rifles	
No.1 Rifle	145-146
Rifle Magazines	147-148
Pistol Magazines	149-150
Legal Information	151-152
Contact Information	153-154

NEW PRODUCT QUICK REFERENCE

Security-9® with Viridian® E-Series™ Red Laser	5
Security-9® with Hogue® Grip	5
SR1911® Officer-Style in .45 Auto	14
LCP® II with Extended Magazine	19
Mark IV™ 22/45™ Lite with Diamond Gray Anodized Finish and Laminate, Target Grips	32
Mark IV™ 22/45™ Lite with Gold Anodized Finish and Black Barrel	32
Mark IV™ 22/45™ Lite with Black Anodized Finish and Gold Barrel	32
Ruger SP101® with Blued Finish	42
Redhawk® with Sleeve and Shroud Barrel	48
LCRx® with 3" Barrel and Adjustable Rear Sight in .357 Magnum	56
10/22® Carbine with GO Wild® Camo Rock-Star Stock	77
10/22® Carbine with Spinning Target and Hard Case	77
10/22® Compact	77
10/22® Target Lite with Red and Black Laminate Thumbhole Stock	78
AR-556® with Magpul® Furniture	93
AR-556® Optics Carbine	93
AR-556® MPR in .450 Bushmaster	95

Ruger Precision® Rifle in .338 Lapua Magnum	105
Ruger Precision® Rifle in .300 Winchester Magnum	105
Ruger Precision® Rimfire in .17 HMR	109
Ruger Precision® Rimfire in .22 WMR	109
Ruger American® Rifle Predator Left-Handed	117
Ruger® Scout Rifle in .450 Bushmaster	127
Hawkeye® Long-Range Target in 6.5 Creedmoor	138
Hawkeye® Long-Range Target in 6.5 PRC	138
Ruger 77/17® with Green Mountain Laminate Stock and Stainless Finish in .17 Hornet	143
Ruger 77/17® with American Walnut Stock and Blued Finish	143

LEFT-HANDED RIFLES

Ruger American® Rifle Predator (Four Models)	117
Ruger® Scout Rifle (One Model)	127
Ruger® Guide Gun (One Model)	131
Hawkeye® African (One Model)	135
Hawkeye® FTW Hunter (Two Models)	139

LEARN MORE ABOUT RUGER® PRODUCTS ONLINE:



facebook.com/Ruger



instagram.com/RugersOfficial



youtube.com/RugerFirearms



pinterest.com/RugerFirearms



SECURITY-9®

When it comes to security, simple and affordable is hard to beat. Ideal for everyday carry and self-defense, the **Security-9®** is an affordable, rugged, mid-sized, centerfire pistol that provides everyday security in the perfect caliber and size, at the perfect price point.



Security-9®
(Model 3810)

SECURITY-9®



9mm
LUGER

ONE CALIBER

FOUR MODELS



NEW Security-9® with
Viridian® E-Series™
Red Laser
(Model 3816)

FEATURES

- Compact for easy concealment, the mid-sized Security-9® is designed to fit a variety of available holsters.
- Rugged construction with blued, through-hardened alloy steel slide and barrel and high-performance, glass-filled nylon grip frame.
- Precision-machined, hard-coat anodized aluminum chassis with full-length guide rails.
- The Secure Action used in the LCP® II and Security-9® is derived from the reliable and proven hammer-fired LCP® fire control system. The Secure Action combines the smooth trigger pull of the LCP® with the short, crisp feel and positive reset of a single-action.
- Textured grip frame provides a secure and comfortable grip.
- Dovetailed, high-visibility sight system with drift adjustable rear sight and fixed front sight. Sights can be easily changed out for different color options (available separately).
- Internal, Secure Action hammer provides strong ignition force, yet allows for easier slide racking when compared with many striker-fired pistols. Front cocking serrations enable positive slide manipulation.
- Safety features include integrated trigger safety; external manual safety; neutrally balanced sear with significant engagement and strong spring tension; and hammer catch to help prevent the hammer from contacting the firing pin unless the trigger is pulled.
- Safe, easy takedown with no special tools or trigger pull required.
- Also includes: two alloy steel magazines.



Textured Grip Frame For Secure and Comfortable Grip



Front Cocking Serrations



Eye-Catching Sights for Superior Visibility



External Manual Safety



Secure Action Fire Control System Provides the Crisp Feel of a Hammer-Fired Single-Action

Model Number	Caliber	Capacity	Slide/Finish	Grip Frame	Feature	Sights	Barrel Length	Overall Length	Height	Slide Width	Weight	Twist	Suggested Retail
3810*	9mm Luger	15+1	Alloy Steel/Blued	Black, High-Performance, Glass-Filled Nylon	—	Drift Adjustable 3-Dot	4"	7.24"	5"	1.02"	23.8 oz.	1:10"	\$379.00
3811**	9mm Luger	10+1	Alloy Steel/Blued	Black, High-Performance, Glass-Filled Nylon	—	Drift Adjustable 3-Dot	4"	7.24"	5"	1.02"	23.8 oz.	1:10"	\$379.00
NEW 3816*	9mm Luger	15+1	Alloy Steel/Blued	Black, High-Performance, Glass-Filled Nylon	Viridian® E-Series™ Red Laser	Drift Adjustable 3-Dot	4"	7.24"	5"	1.02"	24.3 oz.	1:10"	\$439.00
NEW 3819*	9mm Luger	15+1	Alloy Steel/Blued	Black, High-Performance, Glass-Filled Nylon	Hogue® Grip	Drift Adjustable 3-Dot	4"	7.24"	5"	1.02"	24.5 oz.	1:10"	\$399.00

* Some magazines are not available for sale in all states and locales due to laws and regulations limiting magazine capacity. Prior to purchasing, please check your state and local regulations to verify that you may legally possess such magazines. ** Ships with two, 10-round magazines.





RUGER AMERICAN® PISTOL

Designed with the latest U.S. Military Standards in mind, the **Ruger American® Pistol** is built to perform in the harshest conditions. A true American innovation, this pistol is a revolutionary platform for Ruger – one that combines a recoil-reducing barrel cam (which is designed to better spread recoil energy over time) with a low-mass slide, low center of gravity and low bore axis to provide an unparalleled shooting experience.



Ruger American® Pistol Compact in .45 Auto (Model 8648)

RUGER AMERICAN® PISTOL



9mm LUGER

45 AUTO

TWO CALIBERS

FIFTEEN MODELS

ENVIRONMENTAL PERFORMANCE:

Engineered to Withstand Arctic Temperatures, Desert Heat and Dust, Rainforest Humidity, Ocean Salt and Surf.

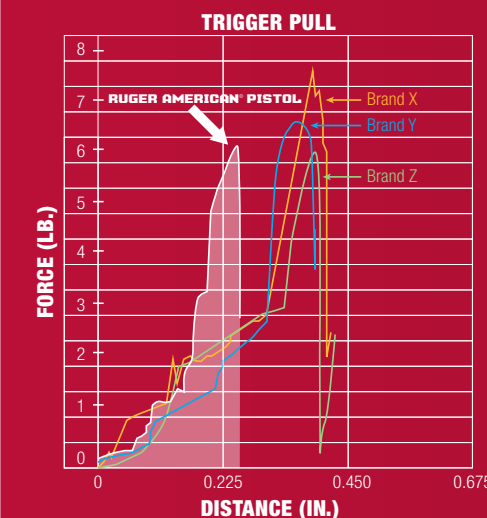

Ruger American® Pistol Pro Duty in 9mm Luger (Model 8605)

FEATURES

- Pre-tensioned striker system features a powerful striker spring for positive ignition without a heavier trigger pull.
- Barrel cam distributes recoil forces over a longer period of time to reduce felt recoil.
- Safe, easy takedown with no tools or trigger pull required.
- Rigid, one-piece, precision-machined, black nitrided, stainless steel chassis with integral frame rails and fire control housing.
- Modular, wrap-around grip system allows for adjustment of palm swell and trigger reach to fit a wide range of hand sizes. Ergonomic grip modules lock in solidly and do not loosen.
- Genuine Novak® LoMount Carry three-dot sights with wide rear notch for rapid sight acquisition and alignment.
- Ambidextrous slide stop and magazine release.
- Performance tested for sustained +P ammunition use.

- Black nitride finish on stainless steel slide and chassis is durable, non-reflective and corrosion-resistant.
- MIL-STD-1913 Picatinny rail acts as a mounting point for a wide variety of standard lights and lasers.
- Non-slip surfaces include functional slide serrations and purpose-oriented grip frame texturing for enhanced control.
- Safety features include internal, automatic sear block system, ambidextrous manual safety and integrated trigger safety. Pro models come without manual safety.
- Also includes: two nickel-Teflon® plated steel magazines; small (9mm Luger models only), medium and large grip modules.

9mm RUGER AMERICAN® PISTOL OWNERS: SEE INSIDE BACK COVER FOR AN IMPORTANT **PRODUCT SAFETY BULLETIN** FROM RUGER!



Short Takeup Trigger with Positive Reset



Genuine Novak® LoMount Carry Three-Dot Sights



Recoil-Reducing Barrel Cam, Low-Mass Slide, Low Center of Gravity and Low Bore Axis



Modular, Wrap-Around Grip System for Adjusting Palm Swell and Trigger Reach



Safe, Easy Takedown with No Tools or Trigger Pull Required



Ambidextrous Slide Stop, Manual Safety and Magazine Release Allow Actuation with Either Hand (Pro Models Come without External Safety)

RUGER AMERICAN® PISTOL DUTY



Model 8615 Shown



Available with or without Manual Safety

COMPARE		Capacity	Slide/Finish	Grip Frame	Sights	Safety Option	Barrel Length	Overall Length	Height	Width	Weight	Twist	Suggested Retail
Model Number	Caliber												
8605* Pro	9mm Luger	17+1	Stainless Steel/Black Nitride	One-Piece, High-Performance, Glass-Filled Nylon	Novak® LoMount Carry 3-Dot	Integrated Trigger Safety Only	4.20"	7.50"	5.60"	1.40"	30 oz.	1:10"	\$579.00
8607 Pro	9mm Luger	10+1	Stainless Steel/Black Nitride	One-Piece, High-Performance, Glass-Filled Nylon	Novak® LoMount Carry 3-Dot	Integrated Trigger Safety Only	4.20"	7.50"	5.60"	1.40"	30 oz.	1:10"	\$579.00
8608*	9mm Luger	17+1	Stainless Steel/Black Nitride	One-Piece, High-Performance, Glass-Filled Nylon	Novak® LoMount Carry 3-Dot	Manual Safety	4.20"	7.50"	5.60"	1.50"	30.5 oz.	1:10"	\$579.00
8638	9mm Luger	10+1	Stainless Steel/Black Nitride	One-Piece, High-Performance, Glass-Filled Nylon	Novak® LoMount Carry 3-Dot	Manual Safety	4.20"	7.50"	5.60"	1.50"	30.5 oz.	1:10"	\$579.00
8661**	9mm Luger	10+1	Stainless Steel/Black Nitride	One-Piece, High-Performance, Glass-Filled Nylon	Novak® LoMount Carry 3-Dot	Manual Safety	4.20"	7.50"	5.60"	1.50"	30.5 oz.	1:10"	\$579.00
8615 Pro	45 Auto	10+1	Stainless Steel/Black Nitride	One-Piece, High-Performance, Glass-Filled Nylon	Novak® LoMount Carry 3-Dot	Integrated Trigger Safety Only	4.50"	8"	5.70"	1.40"	31.5 oz.	1:16"	\$579.00
8618	45 Auto	10+1	Stainless Steel/Black Nitride	One-Piece, High-Performance, Glass-Filled Nylon	Novak® LoMount Carry 3-Dot	Manual Safety	4.50"	8"	5.70"	1.50"	32.5 oz.	1:16"	\$579.00
8680**	45 Auto	10+1	Stainless Steel/Black Nitride	One-Piece, High-Performance, Glass-Filled Nylon	Novak® LoMount Carry 3-Dot	Manual Safety	4.50"	8"	5.70"	1.50"	32.5 oz.	1:16"	\$579.00

RUGER AMERICAN® PISTOL COMPACT



Model 8648 Shown



Available with or without Manual Safety

COMPARE		Capacity	Slide/Finish	Grip Frame	Sights	Safety Option	Barrel Length	Overall Length	Height	Width	Weight	Twist	Suggested Retail
Model Number	Caliber												
8635* Pro	9mm Luger	17+1	Stainless Steel/Black Nitride	One-Piece, High-Performance, Glass-Filled Nylon	Novak® LoMount Carry 3-Dot	Integrated Trigger Safety Only	3.55"	6.65"	4.48"	1.40"	28.7 oz.	1:10"	\$579.00
8637 Pro	9mm Luger	10+1	Stainless Steel/Black Nitride	One-Piece, High-Performance, Glass-Filled Nylon	Novak® LoMount Carry 3-Dot	Integrated Trigger Safety Only	3.55"	6.65"	4.48"	1.40"	28.7 oz.	1:10"	\$579.00
8639*	9mm Luger	17+1	Stainless Steel/Black Nitride	One-Piece, High-Performance, Glass-Filled Nylon	Novak® LoMount Carry 3-Dot	Manual Safety	3.55"	6.65"	4.48"	1.50"	29.2 oz.	1:10"	\$579.00
8633	9mm Luger	10+1	Stainless Steel/Black Nitride	One-Piece, High-Performance, Glass-Filled Nylon	Novak® LoMount Carry 3-Dot	Manual Safety	3.55"	6.65"	4.48"	1.50"	29.2 oz.	1:10"	\$579.00
8663**	9mm Luger	10+1	Stainless Steel/Black Nitride	One-Piece, High-Performance, Glass-Filled Nylon	Novak® LoMount Carry 3-Dot	Manual Safety	3.55"	6.65"	4.48"	1.50"	29.2 oz.	1:10"	\$579.00
8645 Pro	45 Auto	10+1	Stainless Steel/Black Nitride	One-Piece, High-Performance, Glass-Filled Nylon	Novak® LoMount Carry 3-Dot	Integrated Trigger Safety Only	3.75"	7.25"	4.65"	1.40"	28.6 oz.	1:16"	\$579.00
8648	45 Auto	10+1	Stainless Steel/Black Nitride	One-Piece, High-Performance, Glass-Filled Nylon	Novak® LoMount Carry 3-Dot	Manual Safety	3.75"	7.25"	4.65"	1.50"	29 oz.	1:16"	\$579.00

* Some magazines are not available for sale in all states and locales due to laws and regulations limiting magazine capacity. Prior to purchasing, please check your state and local regulations to verify that you may legally possess such magazines. ** Ships with large grip module installed.



SR1911[®]

A classically styled pistol, the **SR1911[®]** has been designed with modern features to make an ergonomic, accurate, rugged and reliable pistol.



SR1911[®] Target
(Model 6736)



NEW **SR1911[®] Officer-Style**
in .45 Auto
(Model 6762)

SR1911[®]



**45
AUTO**

**9mm
LUGER**

**10mm
AUTO**

THREE CALIBERS

NINE MODELS

FULL-SIZE

**COMMANDER-
STYLE**

**OFFICER-
STYLE**

TARGET

FEATURES

- Classic, original 1911 fire control.
- Precision CNC-controlled machining process results in a superior slide-to-frame fit and smooth slide travel.
- Positive barrel lock-up allows for superior accuracy out of the box.
- Oversized ejection port and extended magazine release enhance performance.
- Traditional design with replaceable grip panels and checkered backstrap.
- Lightweight, aluminum, skeletonized trigger provides a very crisp, no creep, light trigger pull with a quick, positive reset.
- Skeletonized hammer and titanium firing pin for faster lock time.
- Oversized beavertail grip safety provides positive function and reliability.
- Extended thumb safety and slide stop lever for improved, positive manipulation.
- Integral plunger tube for slide stop and thumb safety is not staked and will never come loose.
- Features a flat mainspring housing and rear slide serrations for a positive grip.
- Inspection port allows for visual confirmation of a loaded or empty chamber.
- Accepts most standard, aftermarket 1911 parts and accessories.
- Models 6758, 6762, 6739 and 6759 feature a bushingless bull barrel.
- Model 6711 features a polished titanium feed ramp.
- Also includes: two stainless steel magazines.



Available in a Variety of Grip Configurations



Lightweight, Aluminum, Skeletonized Trigger



Superior Slide-to-Frame Fit



Oversized Beavertail Grip Safety



Stainless Steel Barrel and Bushing (Excludes Models 6758, 6762, 6739 and 6759)

SR1911® FULL-SIZE



Drift Adjustable Novak® Three-Dot Sights

Model Number	Caliber	Capacity	Slide/Finish	Grip Frame/Finish	Grip Panels	Sights	Barrel Length	Overall Length	Height	Width	Weight †	Twist	Suggested Retail
6700*	45 Auto	8+1	Stainless Steel/Low-Glare Stainless	Stainless Steel/Low-Glare Stainless	Hardwood	Drift Adjustable Novak® 3-Dot	5"	8.67"	5.45"	1.34"	39 oz.	1:16"	\$939.00

SR1911® COMMANDER-STYLE



Model 6722 Shown



Drift Adjustable Novak® Three-Dot Sights



Steel and Aluminum Frames Available

Model Number	Caliber	Capacity	Slide/Finish	Grip Frame/Finish	Grip Panels	Sights	Barrel Length	Overall Length	Height	Width	Weight †	Twist	Suggested Retail
6702**	45 Auto	7+1	Stainless Steel/Low-Glare Stainless	Stainless Steel/Low-Glare Stainless	Hardwood	Drift Adjustable Novak® 3-Dot	4.25"	7.75"	5.45"	1.34"	36.4 oz.	1:16"	\$939.00
6711**	45 Auto	7+1	Stainless Steel/Low-Glare Stainless	Aluminum/Black Anodized	Hardwood	Drift Adjustable Novak® 3-Dot	4.25"	7.75"	5.45"	1.34"	29.3 oz.	1:16"	\$979.00
6722***	9mm Luger	9+1	Stainless Steel/Low-Glare Stainless	Aluminum/Gray Anodized	Black Rubberized	Drift Adjustable Novak® 3-Dot	4.25"	7.75"	5.45"	1.34"	29.3 oz.	1:10"	\$979.00

SR1911® OFFICER-STYLE



NEW

Model 6762 Shown



Steel and Aluminum Frames Available



Deluxe Checkered G10 Grip Panels



3.60" Officer-Style Barrel Length with Bushingless Bull Barrel

Model Number	Caliber	Capacity	Slide/Finish	Grip Frame/Finish	Grip Panels	Sights	Barrel Length	Overall Length	Height	Width	Weight †	Twist	Suggested Retail
6758**	9mm Luger	7+1	Stainless Steel/Low-Glare Stainless	Aluminum/Black Anodized	Deluxe Checkered G10	Drift Adjustable Novak® 3-Dot	3.60"	7.25"	5"	1.34"	27.2 oz.	1:10"	\$979.00
NEW 6762**	45 Auto	7+1	Stainless Steel/Low-Glare Stainless	Stainless Steel/Low-Glare Stainless	Deluxe Checkered G10	Drift Adjustable Novak® 3-Dot	3.60"	7.25"	5"	1.34"	31 oz.	1:16"	\$979.00

SR1911® TARGET



Model 6739 Shown



Models 6736 and 6759 Feature Ambidextrous Extended Thumb Safety



Models 6739 and 6759 Feature Bushingless Bull Barrel



Adjustable Target Sights

Model Number	Caliber	Capacity	Slide/Finish	Grip Frame/Finish	Grip Panels	Sights	Barrel Length	Overall Length	Height	Width	Weight †	Twist	Suggested Retail
6736*	45 Auto	8+1	Stainless Steel/Low-Glare Stainless	Stainless Steel/Low-Glare Stainless	Deluxe Checkered G10	Adjustable Target	5"	8.67"	5.45"	1.34"	39 oz.	1:16"	\$1,019.00
6739*	10mm Auto	8+1	Stainless Steel/Low-Glare Stainless	Stainless Steel/Low-Glare Stainless	Black Rubberized	Adjustable Target	5"	8.67"	5.45"	1.34"	40.4 oz.	1:16"	\$1,019.00
6759***	9mm Luger	9+1	Stainless Steel/Low-Glare Stainless	Stainless Steel/Low-Glare Stainless	Deluxe Checkered G10	Adjustable Target	5"	8.67"	5.45"	1.45"	41.9 oz.	1:10"	\$1,019.00

* Ships with one, 7-round and one, 8-round magazine. ** Ships with two, 7-round magazines. *** Ships with two, 9-round magazines. † With empty magazine.



RUGER® LIGHTWEIGHT, COMPACT PISTOLS

Ruger offers lightweight, compact pistols for every personal protection need.



EC9s®
(Model 3283)

RUGER® LIGHTWEIGHT, COMPACT PISTOLS



EC9s®

LC380CA™

LCP®

LCP® II

TWO CALIBERS

FOUR FAMILIES



NEW

**LCP® II with
Extended Magazine**
(Model 3787)



LC380CA™
(Model 3253)



FEATURES

- Striker-fired with a short, light, crisp trigger pull for faster, more accurate shooting.
- Slim, lightweight and compact for personal protection. Just slightly larger than the popular and incredibly compact LCP®.
- Rugged construction with through-hardened steel slide and one-piece, high-performance, glass-filled nylon grip frame.
- Checkered grip frame provides a secure and comfortable grip.
- Includes finger grip extension floorplate that can be added to the magazine for comfort and improved grip.
- Sights are machined integrally with the slide and feature glare-reducing, rear-facing serrations.
- Blued, alloy steel barrel.
- Safety features include integrated trigger safety, manual safety, magazine disconnect and inspection port that allows for visual confirmation of a loaded or empty chamber.
- Also includes: one, 7-round magazine.



EC9s®



EC9s®
(Model 3283)

**CONSIDER THE NEW EC9s®
YOUR EVERYDAY AFFORDABLE,
CONCEALED CARRY PISTOL.**



Integral Sights

Model Number	Caliber	Capacity	Slide/Finish	Grip Frame	Sights	Barrel Length	Overall Length	Height	Width	Weight	Twist	Suggested Retail
3283	9mm Luger	7+1	Alloy Steel/Black Oxide	Black, High-Performance, Glass-Filled Nylon	Integral	3.12"	6"	4.50"	0.90"	17.2 oz.	1:10"	\$299.00



FEATURES

- Same compact size as the popular EC9s® with the reduced recoil of the .380 Auto cartridge for a softer-shooting concealed carry pistol.
- Rugged construction with through-hardened steel slide and one-piece, high-performance, glass-filled nylon grip frame.
- Checkered grip frame provides a secure and comfortable grip.
- Includes finger grip extension floorplate that can be added to the magazine for comfort and grip.
- Dovetailed, high-visibility, three-dot sight system with drift adjustable rear sight and fixed front sight.
- Blued, alloy steel barrel.
- Safety features include internal lock, manual safety, magazine disconnect and patented loaded chamber indicator that allows for visual confirmation of a loaded or empty chamber.
- Also includes: one, 7-round magazine.



LC380CA™
(Model 3253)



LC9® Conversion Kit for LC380CA™ Converts the LC380CA™ (.380 Auto) to Accept 9mm Luger
Available At ShopRuger.com



Chambered in Reliable and Effective .380 Auto



Easy-to-Rack Slide

LC380CA™

Model Number	Caliber	Capacity	Slide/Finish	Grip Frame	Sights	Barrel Length	Overall Length	Height	Width	Weight	Twist	Suggested Retail
3253	380 Auto	7+1	Alloy Steel/Blued	Black, High-Performance, Glass-Filled Nylon	Drift Adjustable 3-Dot	3.12"	6"	4.50"	0.90"	17.2 oz.	1:16"	\$539.00



FEATURES

- Compact and lightweight, the LCP® and LCP® II are designed to fit a variety of holsters.
- Textured grip frame provides a secure and comfortable grip.
- Fixed front and rear sights are integral to the slide, while the hammer is recessed within the slide.
- Rugged construction with through-hardened steel slide and one-piece, high-performance, glass-filled nylon grip frame.
- Includes finger grip extension floorplate that can be added to the magazine for comfort and improved grip.

- LCP® II models feature the Secure Action fire control that combines the smooth pull of the LCP® with the short crisp feel and positive reset of a single-action.
- LCP® II safety features include an integrated trigger safety; neutrally balanced sear with significant engagement and strong spring tension; and hammer catch to help prevent the hammer from contacting the firing pin unless the trigger is pulled.
- Blued, alloy steel barrel.
- Also includes: one magazine.



LCP®



**Moon Shine Camo®
Harvest Moon® Grip Frame**
(Model 3763)



**Moon Shine Camo®
Toxic® Grip Frame**
(Model 3769)



Model Number	Caliber	Capacity	Slide/Finish	COMPARE		Barrel Length	Overall Length	Height	Width	Weight	Twist	Suggested Retail
				Grip Frame	Sights							
3701	380 Auto	6+1	Alloy Steel/Blued	Black, High-Performance, Glass-Filled Nylon	Integral	2.75"	5.16"	3.60"	0.82"	9.6 oz.	1:16"	\$259.00
3752	380 Auto	6+1	Alloy Steel/Blued	Black, High-Performance, Glass-Filled Nylon	Integral/Viridian® E-Series™ Red Laser	2.75"	5.16"	3.60"	0.82"	10.4 oz.	1:16"	\$349.00
3763	380 Auto	6+1	Alloy Steel/Blued	Harvest Moon® High-Performance, Glass-Filled Nylon	Integral	2.75"	5.16"	3.60"	0.82"	9.6 oz.	1:16"	\$299.00
3769	380 Auto	6+1	Alloy Steel/Blued	Toxic® High-Performance, Glass-Filled Nylon	Integral	2.75"	5.16"	3.60"	0.82"	9.6 oz.	1:16"	\$299.00

LCP® II



**Moon Shine Camo®
Harvest Moon® Grip Frame**
(Model 3767)

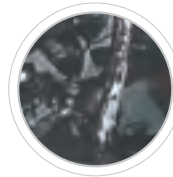

**Moon Shine Camo®
Toxic® Grip Frame**
(Model 3765)



Model Number	Caliber	Capacity	Slide/Finish	COMPARE		Barrel Length	Overall Length	Height*	Width	Weight	Twist	Suggested Retail
				Grip Frame	Sights							
3750	380 Auto	6+1	Alloy Steel/Blued	Black, High-Performance, Glass-Filled Nylon	Integral	2.75"	5.17"	3.71"	0.91"	10.6 oz.	1:16"	\$349.00
3758	380 Auto	6+1	Alloy Steel/Blued	Black, High-Performance, Glass-Filled Nylon	Integral/Viridian® E-Series™ Red Laser	2.75"	5.17"	3.71"	0.91"	11.4 oz.	1:16"	\$439.00
3765	380 Auto	6+1	Alloy Steel/Blued	Toxic® High-Performance, Glass-Filled Nylon	Integral	2.75"	5.17"	3.71"	0.91"	10.6 oz.	1:16"	\$399.00
3767	380 Auto	6+1	Alloy Steel/Blued	Harvest Moon® High-Performance, Glass-Filled Nylon	Integral	2.75"	5.17"	3.71"	0.91"	10.6 oz.	1:16"	\$399.00
NEW 3787	380 Auto	7+1	Alloy Steel/Blued	Black, High-Performance, Glass-Filled Nylon	Integral	2.75"	5.17"	4.40"	0.91"	11 oz.	1:16"	\$399.00

LCP® II FEATURES



Larger Grip Surface for Better Distribution of Recoil Forces



Improved Sights for Superior Visibility



Short, Crisp Trigger Pull with Single-Action Feel



Easy-to-Rack Slide Designed to Hold Open After Last Round Ejection





SR22®

The do-it-all .22 LR pistol for the shooter who appreciates style and demands reliability, the **SR22®** is packed with versatile features. It is lightweight, easy to field strip, fun to shoot and will run reliably with a wide variety of ammunition (not just high-velocity ammunition).



SR22® with 4.50" Barrel (Model 3620)

SR22®



ONE CALIBER

SIX MODELS

SR22® THREADED BARREL KIT*

Comes with Factory-Manufactured Stainless Steel Barrel, Thread Protector, Adapter and Wrench. BUY NOW AT SHOPRUGER.COM



Threaded Barrel (Model 3604)



Accepts any .22 Caliber 1/2"-28 Muzzle Device (Not Included) – Thread Protector, Adapter and Wrench Provided



SR22® with Silver Anodized Slide Finish (Model 3607)

* Compatible with SR22® pistols bearing serial numbers 361-7XXXX and higher. Not available in states that prohibit threaded barrels.

FEATURES

- Light double-action and crisp single-action trigger pulls. External hammer is designed with a rounded spur for easy cocking and single-action shooting.
- Polymer frame and two interchangeable rubberized grips with angled serrations allow shooters to select either a slim or wider palm swell option (no tools required).
- The aerospace-grade aluminum slide has serrations on both the front and rear for better grip and slide manipulation.
- The dovetailed, high-visibility, three-dot sight system has a fixed front sight and a rear sight that is both windage- and elevation-adjustable. A reversible blade allows shooters to select two white dots or a solid black blade.
- The easy-to-use underside Picatinny rail features multiple cross slots for variable mounting of most popular accessories.
- Inspection port allows for visual confirmation of a loaded or empty chamber.
- Readily replaceable stainless steel barrel.
- Ambidextrous manual thumb safety/decocking lever and magazine release.
- Easy to field strip.
- Also includes: two, 10-round magazines; two finger grip extension floorplates.



SR22® with 4.50" Barrel
(Model 3620)



SR22® with Threaded Barrel
(Model 3604*)



Model Number	Caliber	Capacity	COMPARE										Suggested Retail
			Slide/Finish	Grip Frame	Sights	Thread Pattern	Barrel Length	Overall Length	Height	Width	Weight	Twist	
3600	22 LR	10+1	Aluminum/Black Anodized	Black Polymer	Adjustable 3-Dot	—	3.50"	6.40"	4.90"	0.97"	17.5 oz.	1:16"	\$439.00
3604*	22 LR	10+1	Aluminum/Black Anodized	Black Polymer	Adjustable 3-Dot	1/2"-28	3.50"	6.40"†	4.90"	0.97"	17.5 oz.	1:16"	\$479.00
3607	22 LR	10+1	Aluminum/Silver Anodized	Black Polymer	Adjustable 3-Dot	—	3.50"	6.40"	4.90"	0.97"	17.5 oz.	1:16"	\$469.00
3620	22 LR	10+1	Aluminum/Black Anodized	Black Polymer	Adjustable 3-Dot	—	4.50"	7.40"	4.90"	0.97"	18.7 oz.	1:16"	\$459.00
3633	22 LR	10+1	Aluminum/Black Anodized	Toxic® Polymer	Adjustable 3-Dot	—	3.50"	6.40"	4.90"	0.97"	17.5 oz.	1:16"	\$479.00
3637	22 LR	10+1	Aluminum/Black Anodized	Harvest Moon® Polymer	Adjustable 3-Dot	—	3.50"	6.40"	4.90"	0.97"	17.5 oz.	1:16"	\$479.00



External Hammer with a Rounded Spur for Easy Cocking



Picatinny Rail with Multiple Cross Slots for Mounting a Variety of Accessories



Ambidextrous Manual Thumb Safety/Decocking Lever and Magazine Release



Fixed, White Dot Front Sight and Adjustable Rear Sight with Reversible Blade



Reduced Moon Shine Camo® Grip Frame Models Available



Two Grip Options for Slim or Wider Palm Swell

* Pistols with threaded barrels are not available in all states and locales due to laws containing feature-based restrictions. Prior to purchasing, please check your state and local regulations to verify that you may legally possess such firearms. † With thread protector installed.





MARK IV™

Ruger has long set the standard for reliable, affordable and accurate .22 LR handguns, beginning with the introduction of the Standard Pistol in 1949. Since then, the Standard Pistol has undergone a series of enhancements with the development of the Mark I, Mark II™, Mark III™ and now the Mark IV.™ The **Mark IV™** maintains the classic look of the original but adds a simple, one-button takedown for quick and easy field stripping.



Mark IV™ Competition
(Model 40112)



Mark IV™ Standard
(Model 40104)

MARK IV™



22
LR

ONE CALIBER

SEVENTEEN MODELS

STANDARD

TARGET

HUNTER

COMPETITION

TACTICAL

22/45™

22/45™ LITE

22/45™
TACTICAL

FEATURES

- Simple, one-button takedown for quick and easy field-stripping and proper chamber-to-muzzle cleaning. Pressing a button in the back of the frame allows the barrel-receiver assembly to tilt up and off the grip frame without the use of tools.
- One-piece, precision CNC-machined grip frame.
- Cold hammer-forged barrel results in ultra-precise rifling that provides exceptional accuracy and longevity.
- Ergonomic bolt stop.
- Smoothly contoured, comfortable grip features a natural-pointing grip angle with replaceable, checkered or textured grip panels for a non-slip hold. Some models are also available with laminate, target grips featuring wrap-around finger grooves.
- Internal cylindrical bolt construction ensures permanent sight-to-barrel alignment and higher accuracy potential than conventional moving-slide designs.
- Contoured ejection port and easy-to-grasp bolt ears allow for durable and reliable operation round after round.
- Accurate sighting system features a drilled and tapped receiver for Weaver- or Picatinny-style rail for easy mounting of optics (rail included only on tactical models).
- Ambidextrous manual safety can be converted to left-side only with included washer.
- Features a conveniently located push-button magazine release on the left side of the frame.
- Magazine drops free on release for convenient reloading.
- Magazine disconnect prevents discharge when the magazine has been removed.
- Also includes: two, 10-round magazines.

RUGER® MARK IV™ OWNERS: SEE INSIDE BACK COVER FOR AN IMPORTANT PRODUCT SAFETY WARNING AND RECALL NOTICE FROM RUGER!



Available in Multiple Barrel Configurations



Accurate, Adjustable Sighting System



Simple, One-Button Takedown for Quick and Easy Field-Stripping (No Tools Required)



Ambidextrous Manual Safety Positively Locks the Sear When Applied



Available in a Variety of Grip Configurations



MARK IV™ STANDARD

Model 40104 Shown



One-Piece Aluminum Grip Frame

Checkered Synthetic Grips

Tapered Barrel

Model Number	Caliber	Capacity	Upper/Finish	Grip Frame/Finish	Barrel	Grips	Sights	COMPARE		Height	Width	Weight	Twist	Suggested Retail
								Barrel Length	Overall Length					
40104	22 LR	10+1	Alloy Steel/Blued	Aluminum/Anodized	Tapered	Checkered Synthetic	Fixed	4.75"	9"	5.40"	1.20"	28.2 oz.	1:16"	\$449.00
40105	22 LR	10+1	Alloy Steel/Blued	Aluminum/Anodized	Tapered	Checkered Synthetic	Fixed	6"	10.25"	5.40"	1.20"	30.1 oz.	1:16"	\$449.00

MARK IV™ TARGET

Model 40126 Shown



One-Piece, Aluminum or Stainless Steel Grip Frame

Checkered Synthetic or Laminate, Target Grips

Bull Barrel (Model 40126 Features Threaded Barrel)

Model Number	Caliber	Capacity	Upper/Finish	Grip Frame/Finish	Barrel	Grips	Sights	COMPARE		Height	Width	Weight	Twist	Suggested Retail
								Barrel Length	Overall Length					
40101	22 LR	10+1	Alloy Steel/Blued	Aluminum/Anodized	Bull	Checkered Synthetic	Fixed Front, Adjustable Rear	5.50"	9.75"	5.50"	1.20"	35.6 oz.	1:16"	\$529.00
40159	22 LR	10+1	Alloy Steel/Blued	Aluminum/Anodized	Bull	Laminate, Target	Fixed Front, Adjustable Rear	5.50"	9.75"	5.50"	1.46"	35.8 oz.	1:16"	\$569.00
40103	22 LR	10+1	Stainless Steel/Satin Stainless	Stainless Steel/Satin Stainless	Bull	Checkered Synthetic	Fixed Front, Adjustable Rear	5.50"	9.75"	5.50"	1.20"	42.8 oz.	1:16"	\$689.00
40126*	22 LR	10+1	Stainless Steel/Satin Stainless	Stainless Steel/Satin Stainless	Threaded Bull	Checkered Synthetic	Fixed Front, Adjustable Rear	5.50"	9.75"	5.50"	1.20"	42.8 oz.	1:16"	\$699.00

MARK IV™ HUNTER

Model 40118 Shown



One-Piece, Stainless Steel Grip Frame

Checkered Laminate or Laminate, Target Grips

Fluted Bull Barrel

Model Number	Caliber	Capacity	Upper/Finish	Grip Frame/Finish	Barrel	Grips	Sights	COMPARE		Height	Width	Weight	Twist	Suggested Retail
								Barrel Length	Overall Length					
40118	22 LR	10+1	Stainless Steel/Satin Stainless	Stainless Steel/Satin Stainless	Fluted Bull	Checkered Laminate	Fiber Optic Front, Adjustable Rear	6.88"	11.12"	5.50"	1.20"	44 oz.	1:16"	\$769.00
40160	22 LR	10+1	Stainless Steel/Satin Stainless	Stainless Steel/Satin Stainless	Fluted Bull	Laminate, Target	Fiber Optic Front, Adjustable Rear	6.88"	11.12"	5.50"	1.46"	44.2 oz.	1:16"	\$799.00

MARK IV™ COMPETITION

One-Piece, Stainless Steel Grip Frame

Checkered Laminate Grips with Thumb Rest

Slab-Sided Bull Barrel

Model Number	Caliber	Capacity	Upper/Finish	Grip Frame/Finish	Barrel	Grips	Sights	Barrel Length	Overall Length	Height	Width	Weight	Twist	Suggested Retail
40112	22 LR	10+1	Stainless Steel/Satin Stainless	Stainless Steel/Satin Stainless	Slab-Sided Bull	Checkered Laminate with Thumb Rest	Fixed Front, Adjustable Rear	6.88"	11.12"	5.50"	1.75"	45.8 oz.	1:16"	\$749.00

MARK IV™ TACTICAL

Factory-Installed Top and Bottom Picatinny Rails

Checkered Synthetic Grips

Threaded Barrel (1/2"-28) for Popular Muzzle Accessories

Model Number	Caliber	Capacity	Upper/Finish	Grip Frame/Finish	Barrel	Grips	Sights	Barrel Length	Overall Length	Height	Width	Weight	Twist	Suggested Retail
40150*	22 LR	10+1	Alloy Steel/Blued	Aluminum/Anodized	Threaded Bull	Checkered Synthetic	Fixed Front, Adjustable Rear	4.40"	8.50"	5.50"	1.20"	34.6 oz.	1:16"	\$569.00

* Pistols with threaded barrels are not available in all states and locales due to laws containing feature-based restrictions. Prior to purchasing, please check your state and local regulations to verify that you may legally possess such firearms.

FEATURES

- Simple, one-button takedown for quick and easy field-stripping and proper chamber to muzzle cleaning. Pressing a button in the back of the frame allows the barrel-receiver assembly to tilt up and off the grip frame without the use of tools.
- Lite models feature a lightweight, ventilated, aerospace-grade aluminum receiver and a tensioned stainless steel barrel.
- Cold hammer-forged barrel results in ultra-precise rifling that provides exceptional accuracy and longevity.
- Threaded barrel models feature a 1/2"-28 thread pattern for popular muzzle accessories (thread protector included).
- Comfortable, precision-molded polymer grip frame with a serrated frontstrap and checkered backstrap.
- Checkered, 1911-style grip panels for a great appearance and comfortable, non-slip hold.
- Ergonomic bolt stop.
- Internal cylindrical bolt construction ensures permanent sight-to-barrel alignment and higher accuracy potential than conventional moving-slide designs.

- Contoured ejection port and easy-to-grasp bolt ears allow for durable and reliable operation round after round.
- Accurate sighting system features an adjustable rear sight and a factory-installed Picatinny rail for easy mounting of optics (excludes model 40107).
- Ambidextrous manual safety can be converted to left-side only with included washer.
- Features a conveniently located push-button magazine release on the left side of the frame.
- Magazine disconnect prevents discharge when the magazine has been removed.
- Also includes: two, 10-round magazines.



RUGER® MARK IV™ 22/45™ OWNERS: SEE INSIDE BACK COVER FOR AN IMPORTANT **PRODUCT SAFETY WARNING AND RECALL NOTICE** FROM RUGER!



Lightweight, Ventilated, Aerospace-Grade Aluminum Receiver



Ambidextrous Manual Safety Positively Locks the Sear When Applied



Comfortable, Precision-Molded Polymer Grip Frame



Accurate Sighting System Features an Adjustable Rear Sight and a Factory-Installed Picatinny Rail for Easy Mounting of Optics (Excludes Model 40107)



Threaded Barrel Models Feature a 1/2"-28 Thread Pattern for Popular Muzzle Accessories

MARK IV™ 22/45™ LITE



Model 43926 Shown



Checkered 1911-Style or Laminate, Target Grips

Lightweight, Ventilated, Aerospace-Grade Aluminum Barrel-Receiver Assembly

Threaded Barrel (1/2"-28) for Popular Muzzle Accessories (Excludes Models 43917 and 43921)

Model Number	Caliber	Capacity	COMPARE		Grip Frame	Grips	Sights	Barrel Length	Overall Length	Height	Width	Weight	Twist	Suggested Retail
			Upper/Finish	Barrel										
43906*	22 LR	10	Aluminum/Black Anodized	Threaded	Polymer	Checkered 1911-Style	Fixed Front, Adjustable Rear	4.40"	8.40"	5.50"	1.22"	25 oz.	1:16"	\$559.00
43917	22 LR	10	Aluminum/Diamond Gray Anodized	Non-Threaded	Polymer	Checkered 1911-Style	Fixed Front, Adjustable Rear	4.40"	8.40"	5.50"	1.22"	25 oz.	1:16"	\$559.00
NEW 43921	22 LR	10	Aluminum/Diamond Gray Anodized	Non-Threaded	Polymer	Laminate, Target	Fixed Front, Adjustable Rear	4.40"	8.40"	5.50"	1.50"	27 oz.	1:16"	\$599.00
NEW 43926*	22 LR	10	Aluminum/Gold Anodized	Black, Threaded	Polymer	Checkered 1911-Style	Fixed Front, Adjustable Rear	4.40"	8.40"	5.50"	1.22"	25 oz.	1:16"	\$559.00
NEW 43927*	22 LR	10	Aluminum/Black Anodized	Gold, Threaded	Polymer	Checkered 1911-Style	Fixed Front, Adjustable Rear	4.40"	8.40"	5.50"	1.22"	25 oz.	1:16"	\$559.00

MARK IV™ 22/45™ TACTICAL



Factory-Installed Top and Bottom Picatinny Rails

Threaded Barrel (1/2"-28) for Popular Muzzle Accessories

Model Number	Caliber	Capacity	Upper/Finish	Barrel	Grip Frame	Grips	Sights	Barrel Length	Overall Length	Height	Width	Weight	Twist	Suggested Retail
40149*	22 LR	10	Alloy Steel/Blued	Threaded Bull	Polymer	Checkered 1911-Style	Fixed Front, Adjustable Rear	4.40"	8.50"	5.50"	1.22"	33.3 oz.	1:16"	\$529.00

MARK IV™ 22/45™



Bull Barrel

Model Number	Caliber	Capacity	Upper/Finish	Barrel	Grip Frame	Grips	Sights	Barrel Length	Overall Length	Height	Width	Weight	Twist	Suggested Retail
40107	22 LR	10	Alloy Steel/Blued	Bull	Polymer	Checkered 1911-Style	Fixed Front, Adjustable Rear	5.50"	9.75"	5.50"	1.22"	34.4 oz.	1:16"	\$409.00

* Pistols with threaded barrels are not available in all states and locales due to laws containing feature-based restrictions. Prior to purchasing, please check your state and local regulations to verify that you may legally possess such firearms.



SILENT-SR®

Offering top-tier sound reduction, the **Silent-SR®** sound suppressor features best-in-class materials and an advanced design resulting in a lightweight, compact size. It was designed and built by Ruger utilizing the very latest in fluid dynamic simulation and computer numeric controlled (CNC) machining equipment.



Pistol Not Included

Silent-SR®
(Model 19000)

SILENT-SR®



22
LR

22
WMR

17
HMR

5.7X
28mm

RATED FOR .22 LR FULL AUTO, .22 WMR, .17 HMR AND 5.7X28mm PISTOLS AND RIFLES.
REDUCES SOUND PRESSURE LEVELS BY UP TO 40 dB.

THE SILENT-SR® IS COMPATIBLE WITH A HOST OF RUGER® FIREARMS

SR22® Pistol with Threaded Barrel	22 Charger™/22 Charger™ Takedown	10/22 Takedown® Lite
Mark IV™ Target with Threaded Barrel	10/22® Tactical	Ruger American® Rimfire Threaded Barrel Models
Mark IV™ Tactical	10/22® Target Lite	Ruger American® Rimfire Compact Threaded Barrel Models
Mark IV™ 22/45™ Tactical	10/22 Takedown® with Threaded Barrel	Ruger Precision® Rimfire
Mark IV™ 22/45™ Lite	10/22 Takedown® with Fluted .920" Diameter Barrel	

SILENT-SR® .22 LR

FEATURES

- Reduces sound pressure levels of .22 LR, .22 WMR, .17 HMR and 5.7x28mm pistols and rifles by up to 40 dB.
- Rated for .22 LR full auto, .22 WMR, .17 HMR and 5.7x28mm pistols and rifles. Features a standard 1/2"-28 thread pattern for compatibility with most threaded rimfire firearms.
- Patent-pending outer tube and muzzle mount are interlocked to prevent inadvertent disassembly when removing the suppressor from your firearm. Disassembly tool is included.
- Compact and lightweight for balance and portability.
- Easy to disassemble and clean; each piece snaps together to seal the baffles and keep the byproducts of combustion away from the tube and end caps.
- Utilizing a titanium tube, aluminum rear cap, and stainless steel thread mount, baffles and front cap, Ruger has selected the best material for each part to maximize strength and minimize weight without sacrificing durability.



For additional information on National Firearms Act (NFA) item restrictions, visit: RUGER.COM/NFA



Easy Disassembly for Cleaning



Using the Provided Disassembly Tool, Remove the Front and Rear Caps



Slide the Entire Stack of Baffles Out of the Rear of the Suppressor Tube



Snap Apart Each Part of the Baffle Stack



Model Number	Caliber	Material/Finish	Length	Diameter	Weight	Thread Pattern	Suggested Retail
19000*	.22 LR/.22 WMR/.17 HMR/5.7x28mm	Titanium, 17-4 Stainless and Aluminum/Cerakote™	5.37"	1.06"	6.3 oz.	1/2"-28	\$449.00

* Sound suppressors are not available in all states and locales due to laws restricting their ownership and use. Prior to purchasing, please check your state and local regulations to verify that you may legally possess a suppressor.



RUGER® DOUBLE-ACTION REVOLVERS

Combining superior design and engineering with dedicated craftsmanship, **Ruger® Double-Action Revolvers** are packed with features and inspire genuine pride of ownership and provide years of reliable service.

RUGER® DOUBLE-ACTION REVOLVERS



**RUGER
SP101®**

GP100®

REDHAWK®

**SUPER
REDHAWK®**

FOUR FAMILIES



NEW Redhawk®
in .357 Magnum
(Model 5051)

NEW Ruger SP101®
with Blued Finish
(Model 15702)



GP100®
7-Round
(Model 1771)

RUGER SP101®

FEATURES

- Grip frame easily accommodates a variety of custom grips.
- Triple-locking cylinder is locked into the frame at the front, rear and bottom for more positive alignment and dependable operation shot after shot.
- Cushioned rubber grip with black synthetic or hardwood inserts (excludes model 5782) has no exposed metal in the backstrap, making it extremely comfortable.
- Dual chambering allows .357 Magnum models to accept factory .38 Special cartridges.
- Takedown of integrated subassemblies requires no special tools, allowing for easy maintenance and re-assembly.
- Transfer bar mechanism provides an unparalleled measure of security against accidental discharge.



RUGER SP101®



Grip Frame Design



Triple-Locking Cylinder



Available in a Variety of Grip Configurations



Transfer Bar Mechanism



Easy Takedown Requires No Special Tools

RUGER SP101® MATCH CHAMPION®



Full-Lug Barrel with 11° Target Crown for Competition-Level Accuracy



Match-Tuned Action



Dovetailed, Fiber Optic Front and Adjustable Rear Sights



RUGER SP101® with 2.25" Barrel



Pinned, Replaceable Black Ramp Front and Integral Rear Sights

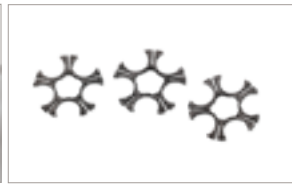

Moon Clips Included with Model 5783 for Convenient Loading



Cushioned Rubber Grip with Black Synthetic Inserts

Model Number	COMPARE		Material/Finish	Grip	Front Sight	Rear Sight	Barrel Length	Overall Length	Weight	Twist	Suggested Retail
	Caliber	Capacity									
5737	38 Spl +P	5	Stainless Steel/Satin Stainless	Cushioned Rubber/Black Synthetic Inserts	Ramp	Integral	2.25"	7.20"	26 oz.	1:18.75"	\$719.00
5718	357 Mag	5	Stainless Steel/Satin Stainless	Cushioned Rubber/Black Synthetic Inserts	Ramp	Integral	2.25"	7.20"	26 oz.	1:16"	\$719.00
5783	9mm Luger	5	Stainless Steel/Satin Stainless	Cushioned Rubber/Black Synthetic Inserts	Ramp	Integral	2.25"	7.20"	25 oz.	1:16"	\$719.00

RUGER SP101® with 3" Barrel



Pinned, Replaceable Black Ramp Front and Integral Rear Sights



Cushioned Rubber Grip with Black Synthetic Inserts

Model Number	Caliber	Capacity	Material/Finish	Grip	Front Sight	Rear Sight	Barrel Length	Overall Length	Weight	Twist	Suggested Retail
5719	357 Mag	5	Stainless Steel/Satin Stainless	Cushioned Rubber/Black Synthetic Inserts	Ramp	Integral	3"	8"	27 oz.	1:16"	\$719.00

RUGER SP101® with Spurless Hammer



Double-Action Only Spurless Hammer is Ideal for a Snag-Free Draw



Pinned, Replaceable Black Ramp Front and Integral Rear Sights



Cushioned Rubber Grip with Black Synthetic Inserts

Model Number	Caliber	Capacity	Material/Finish	Grip	Front Sight	Rear Sight	Barrel Length	Overall Length	Weight	Twist	Suggested Retail
5720	357 Mag	5	Stainless Steel/Satin Stainless	Cushioned Rubber/Black Synthetic Inserts	Ramp	Integral	2.25"	7.20"	25 oz.	1:16"	\$719.00

RUGER SP101® with Blued Finish



Black Ramp Front and Integral Rear Sights



Cushioned Rubber Grip with Engraved Hardwood Inserts

Model Number	Caliber	Capacity	Material/Finish	Grip	Front Sight	Rear Sight	Barrel Length	Overall Length	Weight	Twist	Suggested Retail
NEW 15702	357 Mag	5	Alloy Steel/Blued	Cushioned Rubber, Engraved Hardwood	Black Ramp	Integral	2.25"	7.20"	26 oz.	1:16"	\$719.00

RUGER SP101® with Engraved Hardwood Inserts



Dovetailed, Fiber Optic Front and Adjustable Rear Sights (Excludes Model 5784)



Cushioned Rubber Grip with Engraved Hardwood Inserts

Model Number	COMPARE		Material/Finish	Grip	Front Sight	Rear Sight	Barrel Length	Overall Length	Weight	Twist	Suggested Retail
	Caliber	Capacity									
5765	22 LR	8	Stainless Steel/Satin Stainless	Cushioned Rubber/Engraved Hardwood Inserts	Fiber Optic	Adjustable	4.20"	9.12"	30 oz.	1:16"	\$769.00
5773	327 Fed Mag	6	Stainless Steel/Satin Stainless	Cushioned Rubber/Engraved Hardwood Inserts	Fiber Optic	Adjustable	4.20"	9.12"	29.5 oz.	1:16"	\$769.00
5771	357 Mag	5	Stainless Steel/Satin Stainless	Cushioned Rubber/Engraved Hardwood Inserts	Fiber Optic	Adjustable	4.20"	9.12"	29.5 oz.	1:16"	\$769.00
5784	327 Fed Mag	6	Stainless Steel/Satin Stainless	Cushioned Rubber/Engraved Hardwood Inserts	Ramp	Integral	3"	8"	27 oz.	1:16"	\$749.00

RUGER SP101® MATCH CHAMPION®



Dovetailed, Fiber Optic Front and Adjustable Rear Sights



Custom Stippled, Checkered Hardwood Grip

Model Number	Caliber	Capacity	Material/Finish	Grip	Front Sight	Rear Sight	Barrel Length	Overall Length	Weight	Twist	Suggested Retail
5782	357 Mag	5	Stainless Steel/Gloss Stainless	Altamont Stippled, Checkered Hardwood	Fiber Optic	Adjustable	4.20"	9.12"	30 oz.	1:16"	\$859.00

FEATURES

- Triple-locking cylinder is locked into the frame at the front, rear and bottom for more positive alignment and dependable operation shot after shot.
- Grip frame design easily accommodates a wide variety of custom grips.
- Dual chambering allows .357 Magnum models to accept factory .38 Special cartridges.
- Takedown of integrated subassemblies requires no special tools and allows for easy maintenance and assembly.
- Transfer bar mechanism provides an unparalleled measure of security against accidental discharge.



GP100®



Easy Takedown with No Special Tools Required



Triple-Locking Cylinder



Available in a Variety of Grip Configurations



Grip Frame Design

GP100® MATCH CHAMPION®



Match-Tuned Action



Custom Hogue® Hardwood Grip with Stippled Sides



Slab-Sided Half-Lug Barrel with 11° Target Crown for Competition-Level Accuracy



Chamfered Cylinder Ejector for Convenient Reloading



GP100®



Model 1761 Shown



Heavy, Full-Shrouded Barrel



Recoil-Reducing, Cushioned, Black Rubber Hogue® Monogrip® (Model 1761 Features Smooth Grip)

Model Number	COMPARE			Grips	Front Sight	Rear Sight	Barrel Length	Overall Length	Weight	Twist	Suggested Retail
	Caliber	Capacity	Material/Finish								
1715	357 Mag	6	Stainless Steel/Satin Stainless	Hogue® Monogrip®	Ramp	Integral	3"	8.50"	36 oz.	1:18.75"	\$799.00
1761	44 Special	5	Stainless Steel/Satin Stainless	Hogue® Monogrip®	Fiber Optic	Adjustable	3"	8.50"	36 oz.	1:20"	\$829.00

GP100® with 4.20" Barrel



Model 1705 Shown

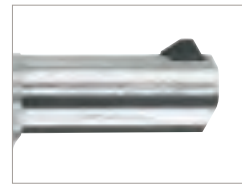

Heavy, Full-Shrouded Barrel



Ramp Front and Adjustable Rear Sight



Recoil-Reducing, Cushioned, Black Rubber Hogue® Monogrip®

Model Number	Caliber	Capacity	COMPARE	Grips	Front Sight	Rear Sight	Barrel Length	Overall Length	Weight	Twist	Suggested Retail
			Material/Finish								
1702	357 Mag	6	Alloy Steel/Blued	Hogue® Monogrip®	Ramp	Adjustable	4.20"	9.50"	40 oz.	1:18.75"	\$769.00
1705	357 Mag	6	Stainless Steel/Satin Stainless	Hogue® Monogrip®	Ramp	Adjustable	4.20"	9.50"	40 oz.	1:18.75"	\$829.00

GP100® with 6" Barrel



Model 1704 Shown



Heavy, Full-Shrouded Barrel



Ramp Front and Adjustable Rear Sights



Recoil-Reducing, Cushioned, Black Rubber Hogue® Monogrip®

Model Number	Caliber	Capacity	COMPARE	Grips	Front Sight	Rear Sight	Barrel Length	Overall Length	Weight	Twist	Suggested Retail
			Material/Finish								
1704	357 Mag	6	Alloy Steel/Blued	Hogue® Monogrip®	Ramp	Adjustable	6"	11.50"	45 oz.	1:18.75"	\$769.00
1707	357 Mag	6	Stainless Steel/Satin Stainless	Hogue® Monogrip®	Ramp	Adjustable	6"	11.50"	45 oz.	1:18.75"	\$829.00

GP100® in .22 LR



Half-Lug Barrel



Fiber Optic Front and Adjustable Rear Sights



Cushioned Rubber Grip with Hardwood Insert

Model Number	Caliber	Capacity	Material/Finish	Grips	Front Sight	Rear Sight	Barrel Length	Overall Length	Weight	Twist	Suggested Retail
1757	22 LR	10	Stainless Steel/Satin Stainless	Cushioned Rubber/Hardwood Inserts	Fiber Optic	Adjustable	5.50"	11"	42 oz.	1:16"	\$829.00

GP100® 7-Round



Model 1771 Shown



Cushioned Rubber Grip with Hardwood Insert or Hogue® Monogrip®

Model Number	COMPARE			Grips	Front Sight	Rear Sight	Barrel Length	Overall Length	Weight	Twist	Suggested Retail
	Caliber	Capacity	Material/Finish								
1774	357 Mag	7	Stainless Steel/Satin Stainless	Cushioned Rubber/Hardwood Inserts	Fiber Optic	Adjustable	2.50"	8"	36 oz.	1:18.75"	\$899.00
1771	357 Mag	7	Stainless Steel/Satin Stainless	Cushioned Rubber/Hardwood Inserts	Fiber Optic	Adjustable	4.20"	9.50"	40 oz.	1:18.75"	\$899.00
1773	357 Mag	7	Stainless Steel/Satin Stainless	Cushioned Rubber/Hardwood Inserts	Fiber Optic	Adjustable	6"	11.50"	43.5 oz.	1:18.75"	\$899.00
1748	327 Fed Mag	7	Stainless Steel/Satin Stainless	Hogue® Monogrip®	Ramp	Adjustable	4.20"	9.50"	40 oz.	1:16"	\$899.00
1764	327 Fed Mag	7	Stainless Steel/Satin Stainless	Hogue® Monogrip®	Ramp	Adjustable	6"	11.50"	45 oz.	1:16"	\$899.00

GP100® MATCH CHAMPION®



Model 1775 Shown



Slab-Sided, Half-Lug Barrel and Fiber Optic Front Sight



Novak® LoMount Carry or Adjustable Rear Sights



Hogue® Stippled Hardwood Grip

Model Number	COMPARE			Grips	Front Sight	Rear Sight	Barrel Length	Overall Length	Weight	Twist	Suggested Retail
	Caliber	Capacity	Material/Finish								
1754	357 Mag	6	Stainless Steel/Satin Stainless	Hogue® Stippled Hardwood	Fiber Optic	Fixed	4.20"	9.50"	38 oz.	1:18.75"	\$969.00
1755	357 Mag	6	Stainless Steel/Satin Stainless	Hogue® Stippled Hardwood	Fiber Optic	Adjustable	4.20"	9.50"	38 oz.	1:18.75"	\$969.00
1775	10mm Auto	6	Stainless Steel/Satin Stainless	Hogue® Stippled Hardwood	Fiber Optic	Adjustable	4.20"	9.50"	37 oz.	1:16"	\$969.00

FEATURES

- Unique, single-spring mechanism allows for a smooth, light trigger pull.
- Triple-locking cylinder is locked into the frame at the front, rear and bottom for more positive alignment and dependable operation shot after shot.
- Easy sighting with readily replaceable colored front blade sight insert and adjustable rear sight with white outline.
- Rugged, stainless steel construction with no side plates is designed specifically to handle powerful magnum loads through extra metal in the top strap, sidewalls and barrel mounting areas.
- Transfer bar mechanism provides an unparalleled measure of security against accidental discharge.
- Cold hammer-forged sleeve and shroud barrel provides outstanding accuracy.
- .44 Magnum models are dual chambered to also accept factory .44 Special cartridges.
- .357 Magnum models are dual chambered to also accept factory .38 Special cartridges.



Cold Hammer-Forged Sleeve and Shroud Barrel



Readily Replaceable Colored Front Blade Sight Insert and Adjustable Rear Sight with White Outline

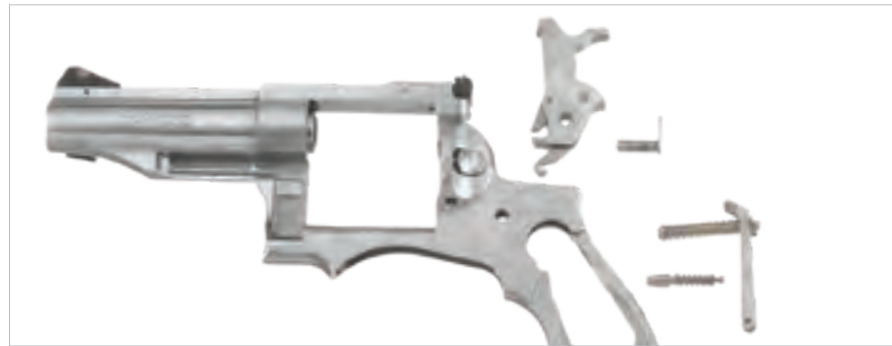

Unique, Single-Spring Mechanism



Triple-Locking Cylinder



Transfer Bar Mechanism



Available in a Variety of Grip Configurations

REDHAWK®



Model 5051 Shown

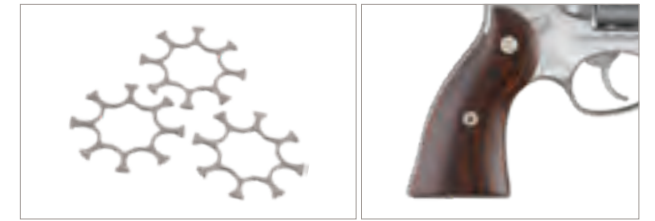

Moon Clips Included with .357 Magnum Models for Convenient Loading

Hardwood Grips

		COMPARE				Barrel Length	Overall Length	Weight	Twist	Suggested Retail
Model Number	Caliber	Capacity	Material/Finish	Grips	Sights					
NEW 5043	44 Rem Mag	6	Stainless Steel/Satin Stainless	Hardwood	Ramp Front, Adjustable Rear	5.50"	11"	49 oz.	1:20"	\$1,079.00
NEW 5041	44 Rem Mag	6	Stainless Steel/Satin Stainless	Hardwood	Ramp Front, Adjustable Rear	7.50"	13"	54 oz.	1:20"	\$1,079.00
NEW 5051	357 Mag	8	Stainless Steel/Satin Stainless	Hardwood	Ramp Front, Adjustable Rear	2.75"	8.25"	44 oz.	1:18.75"	\$1,079.00
5059	357 Mag	8	Stainless Steel/Satin Stainless	Hardwood	Ramp Front, Adjustable Rear	4.20"	9.50"	49 oz.	1:18.75"	\$1,079.00
5060	357 Mag	8	Stainless Steel/Satin Stainless	Hardwood	Ramp Front, Adjustable Rear	5.50"	11"	52 oz.	1:18.75"	\$1,079.00

REDHAWK® in .45 Auto/.45 Colt

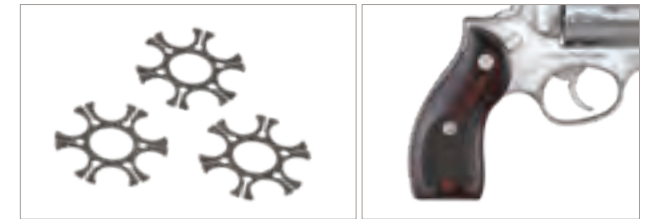

Moon Clips Included with .45 Auto/.45 Colt Models for Convenient Loading

Engraved Hardwood Grips

Model Number	Caliber	Capacity	Material/Finish	Grips	Sights	Barrel Length	Overall Length	Weight	Twist	Suggested Retail
NEW 5050	45 Auto/45 Colt	6	Stainless Steel/Satin Stainless	Engraved Hardwood	Ramp Front, Adjustable Rear	4.20"	9.50"	44 oz.	1:16"	\$1,079.00

REDHAWK® with Hogue® Monogrip®



Black Hogue® Monogrip®

Model Number	Caliber	Capacity	Material/Finish	Grips	Sights	Barrel Length	Overall Length	Weight	Twist	Suggested Retail
NEW 5044	44 Rem Mag	6	Stainless Steel/Satin Stainless	Hogue® Monogrip®	Ramp Front, Adjustable Rear	4.20"	9.50"	47 oz.	1:20"	\$1,079.00

FEATURES

- Triple-locking cylinder is locked into the frame at the front, rear and bottom for more positive alignment and dependable operation shot after shot.
- Corrosion-resistant stainless steel provides durability and reliability, the hallmarks of a Ruger® firearm.
- Strong, extended frame with extra metal in the top strap, sidewalls and barrel mounting areas to handle powerful, big game loads.
- Hogue® Tamer™ Monogrip® with an internal recoil cushion positioned under the web of the hand helps reduce the impact of powerful loads, while the peg-style grip frame easily accommodates custom grips (excludes model 5524).
- Dual chambering allows .44 Magnum models to accept factory .44 Special cartridges and .454 Casull models to accept factory .45 Colt cartridges.
- Transfer bar mechanism provides an unparalleled measure of security against accidental discharge.
- Fixed, replaceable front sight ramp insert and adjustable rear sight (non-Alaskan models feature a red ramp insert).
- Cold hammer-forged barrel results in ultra-precise rifling that provides exceptional accuracy, longevity and easy cleaning.



Strong, Extended Frame



Recoil Reducing, Cushioned, Black Rubber Hogue® Tamer™ Monogrip®



Triple-Locking Cylinder



Fixed, Replaceable Front Ramp Insert and Adjustable Rear Sights



Cold Hammer-Forged Barrel

SUPER REDHAWK®



Model 5501 Shown



Integral Mounts are Machined Directly on the Solid-Steel Barrel Rib to Provide a Stable Mounting Surface for Scope Rings, Eliminating a Potential Source of Looseness and Inaccuracy in the Field (Scope Not Included)

Model Number	COMPARE		Material/Finish	Grip	Sights	Barrel Length	Overall Length	Weight	Twist	Suggested Retail
	Caliber	Capacity								
5507	480 Ruger	6	Stainless Steel/Satin Stainless	Hogue® Tamer™ Monogrip®	Ramp Front, Adjustable Rear	7.50"	13"	53 oz.	1:18"	\$1,189.00
5501	44 Rem Mag	6	Stainless Steel/Satin Stainless	Hogue® Tamer™ Monogrip®	Ramp Front, Adjustable Rear	7.50"	13"	53 oz.	1:20"	\$1,159.00
5502	44 Rem Mag	6	Stainless Steel/Satin Stainless	Hogue® Tamer™ Monogrip®	Ramp Front, Adjustable Rear	9.50"	15"	58 oz.	1:20"	\$1,159.00
5505	454 Casull	6	Stainless Steel/Satin Stainless	Hogue® Tamer™ Monogrip®	Ramp Front, Adjustable Rear	7.50"	13"	52 oz.	1:24"	\$1,189.00

SUPER REDHAWK® in 10mm Auto

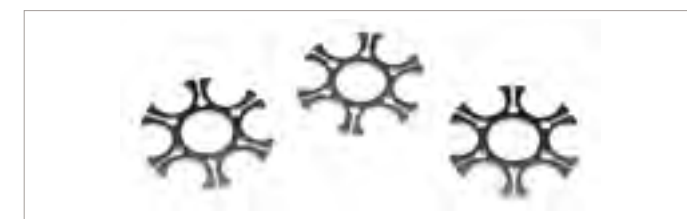

Three (3) Full Moon Clips Included for Convenient Loading

Model Number	Caliber	Capacity	Material/Finish	Grip	Sights	Barrel Length	Overall Length	Weight	Twist	Suggested Retail
5524	10mm Auto	6	Stainless Steel/Satin Stainless	Cushioned Rubber/Hardwood Inserts	Ramp Front, Adjustable Rear	6.50"	12"	54 oz.	1:16"	\$1,159.00

SUPER REDHAWK ALASKAN®



Model 5302 Shown



Compact 2.50" Barrel for Ease of Carry

Model Number	COMPARE		Material/Finish	Grip	Sights	Barrel Length	Overall Length	Weight	Twist	Suggested Retail
	Caliber	Capacity								
5302	480 Ruger	6	Stainless Steel/Satin Stainless	Hogue® Tamer™ Monogrip®	Ramp Front, Adjustable Rear	2.50"	7.62"	44 oz.	1:18"	\$1,189.00
5303	44 Rem Mag	6	Stainless Steel/Satin Stainless	Hogue® Tamer™ Monogrip®	Ramp Front, Adjustable Rear	2.50"	7.62"	45 oz.	1:20"	\$1,189.00
5301	454 Casull	6	Stainless Steel/Satin Stainless	Hogue® Tamer™ Monogrip®	Ramp Front, Adjustable Rear	2.50"	7.62"	44 oz.	1:24"	\$1,189.00



LCR[®]

The **LCR[®]** is the evolution of the revolver. Packed with the latest technological advances and features required by today's most demanding shooters, the LCR[®] is a lightweight, small-frame revolver with a uniquely smooth trigger and highly manageable recoil.



LCR[®]



22
LR

22
WMR

38 SPL
+P

9mm
LUGER

327
FED
MAG

357
MAG

SIX CALIBERS

FIFTEEN MODELS

TRIGGER PULL COMPARISON

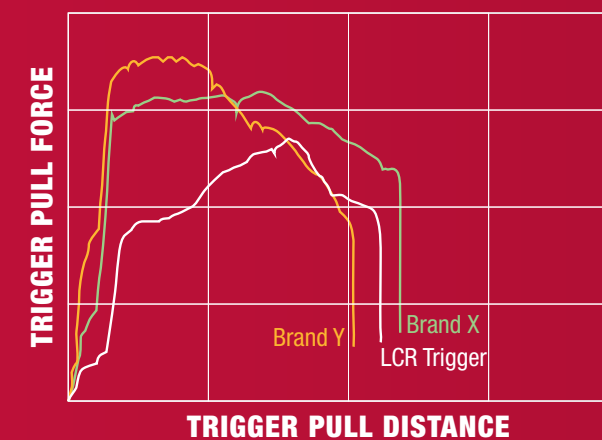

NEW LCRx[®] in .357 Magnum with 3" Barrel and Adjustable Rear Sight (Model 5444)



LCRx[®] in 9mm Luger (Model 5464)

FEATURES

- Monolithic frame is made from aerospace-grade, 7000-series aluminum in .22 LR, .22 Magnum and .38 Special models and from 400-series stainless steel in the powerful .357 Magnum, 9mm Luger and .327 Federal Magnum models.
- Patented friction-reducing cam is a next generation design in fire control systems that results in a smooth, non-stacking trigger pull.
- Patented polymer fire control housing holds all the fire control components in their proper dimensional relationships, reduces weight significantly and helps reduce recoil.
- High-strength stainless steel cylinder, featuring a PVD finish for excellent durability, is extensively fluted, reducing weight.
- Hogue® Tamer™ Monogrip® reduces perceived recoil.

- Grip peg allows for a variety of grip styles to be installed.
- Replaceable, pinned ramp front sight with white bar.
- Models chambered in 9mm Luger ship with three full moon clips that both act as speed loaders and aid in the ejection of spent cartridges.

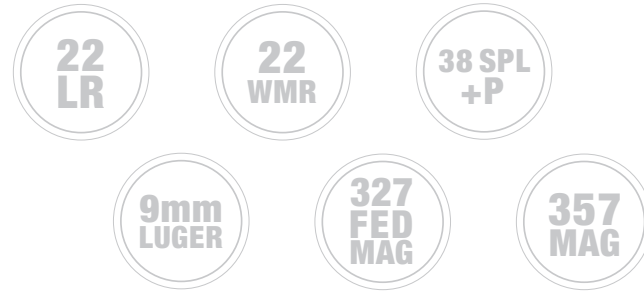

High-Strength Stainless Steel Cylinder



Replaceable, Pinned Ramp Front Sight with White Bar

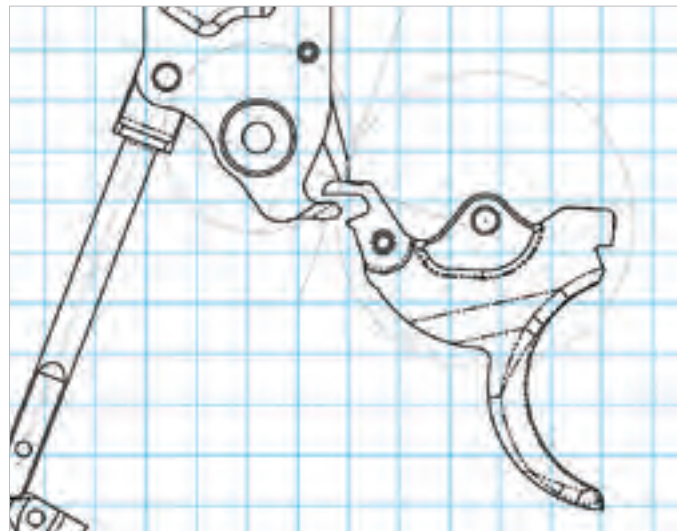

Patented Friction-Reducing Cam



Hogue® Tamer™ Monogrip® Reduces Perceived Recoil



LCR®



Model 5452 Shown



Replaceable, Pinned Ramp Front and Integral U-Notch Rear Sights



Compact Hogue® Tamer™ Monogrip® with Finger Grooves

COMPARE												
Model Number	Caliber	Capacity	Grip	Frame/Finish	Front Sight	Rear Sight	Barrel Length	Overall Length	Height	Weight	Twist	Suggested Retail
5410	22 LR	8	Compact Hogue® Tamer™ Monogrip®	Aluminum/Matte Black	Ramp	Integral	1.87"	6.50"	4.50"	14.9 oz.	1:16"	\$579.00
5414	22 WMR	6	Compact Hogue® Tamer™ Monogrip®	Aluminum/Matte Black	Ramp	Integral	1.87"	6.50"	4.50"	16.6 oz.	1:9"	\$579.00
5401	38 Spl +P	5	Compact Hogue® Tamer™ Monogrip®	Aluminum/Matte Black	Ramp	Integral	1.87"	6.50"	4.50"	13.5 oz.	1:16"	\$579.00
5456	9mm Luger	5	Compact Hogue® Tamer™ Monogrip®	Stainless Steel/Matte Black	Ramp	Integral	1.87"	6.50"	4.50"	17.2 oz.	1:16"	\$669.00
5452	327 Fed Mag	6	Compact Hogue® Tamer™ Monogrip®	Stainless Steel/Matte Black	Ramp	Integral	1.87"	6.50"	4.50"	17 oz.	1:16"	\$669.00
5450	357 Mag	5	Compact Hogue® Tamer™ Monogrip®	Stainless Steel/Matte Black	Ramp	Integral	1.87"	6.50"	4.50"	17.1 oz.	1:16"	\$669.00

LCRx® with 3" Barrel and Adjustable Rear Sight



Model 5444 Shown



Replaceable, Pinned Ramp Front and Adjustable Black Blade Rear Sights



Full-Size Smooth Hogue® Tamer™ Monogrip®



External Hammer for Single-Action Use

COMPARE												
Model Number	Caliber	Capacity	Grip	Frame/Finish	Front Sight	Rear Sight	Barrel Length	Overall Length	Height	Weight	Twist	Suggested Retail
5435	22 LR	8	Full-Size Hogue® Tamer™ Monogrip®	Aluminum/Matte Black	Ramp	Adjustable	3"	7.50"	5.80"	17.3 oz.	1:16"	\$579.00
5437	22 WMR	6	Full-Size Hogue® Tamer™ Monogrip®	Aluminum/Matte Black	Ramp	Adjustable	3"	7.50"	5.80"	17.8 oz.	1:9"	\$579.00
5431	38 Spl +P	5	Full-Size Hogue® Tamer™ Monogrip®	Aluminum/Matte Black	Ramp	Adjustable	3"	7.50"	5.80"	15.7 oz.	1:16"	\$579.00
NEW 5444	357 Mag	5	Full-Size Hogue® Tamer™ Monogrip®	Stainless Steel/Matte Black	Ramp	Adjustable	3"	7.50"	5.80"	21.3 oz.	1:16"	\$669.00

LCRx®



Model 5460 Shown



Replaceable, Pinned Ramp Front and Integral U-Notch Rear Sights



Compact Hogue® Tamer™ Monogrip® with Finger Grooves



External Hammer for Single-Action Use

COMPARE												
Model Number	Caliber	Capacity	Grip	Frame/Finish	Front Sight	Rear Sight	Barrel Length	Overall Length	Height	Weight	Twist	Suggested Retail
5439	22 WMR	6	Compact Hogue® Tamer™ Monogrip®	Aluminum/Matte Black	Ramp	Integral	1.87"	6.50"	4.50"	15.4 oz.	1:9"	\$579.00
5430	38 Spl +P	5	Compact Hogue® Tamer™ Monogrip®	Aluminum/Matte Black	Ramp	Integral	1.87"	6.50"	4.50"	13.5 oz.	1:16"	\$579.00
5464	9mm Luger	5	Compact Hogue® Tamer™ Monogrip®	Stainless Steel/Matte Black	Ramp	Integral	1.87"	6.50"	4.50"	17.4 oz.	1:16"	\$669.00
5462	327 Fed Mag	6	Compact Hogue® Tamer™ Monogrip®	Stainless Steel/Matte Black	Ramp	Integral	1.87"	6.50"	4.50"	17.7 oz.	1:16"	\$669.00
5460	357 Mag	5	Compact Hogue® Tamer™ Monogrip®	Stainless Steel/Matte Black	Ramp	Integral	1.87"	6.50"	4.50"	17.1 oz.	1:16"	\$669.00



RUGER® SINGLE-ACTION REVOLVERS

With superb grip, balance and mechanical simplicity, **Ruger® Single-Action Revolvers** are offered in a wide variety of sizes and calibers, and include features that are sure to please any fan of these timeless firearms.

RUGER® SINGLE-ACTION REVOLVERS



**NEW
VAQUERO**

**NEW MODEL
SUPER
BLACKHAWK®**

**NEW MODEL
BLACKHAWK®**

**NEW MODEL
SINGLE-SIX®**

**NEW
BEARCAT®**

FIVE FAMILIES



**New Vaquero
in .357 Magnum
with Blued Finish
(Model 5106)**



**Single-Ten®
(Model 8100)**



**New Vaquero in .357 Magnum
with High-Gloss Stainless Finish
(Model 5109)**

RUGER NEW VAQUERO

FEATURES

- Traditional western-style, hand-filling grip has long been acknowledged as one of the most comfortable and natural-pointing of any grip style.
- Patented reverse indexing pawl allows for easier loading and unloading, while the traditional beveled cylinder simplifies holstering.
- Transfer bar mechanism and loading gate interlock provide an unparalleled measure of security against accidental discharge.
- Handsome, larger crescent-shaped ejector rod head boasts traditional form, perfect for every cowboy or cowgirl.
- Cold hammer-forged barrel results in ultra-precise rifling that provides exceptional accuracy and longevity.
- Blade front and integral notch rear sights.
- Models chambered in .357 Magnum also accept factory .38 Special cartridges.



Traditional Western-Style, Hand-Filling Grip

Blade Front and Integral Notch Rear Sights

Patented Reverse Indexing Pawl

Transfer Bar Mechanism

THE GUN THAT WON THE NEW WEST

NEW VAQUERO with Blued Finish



Model 5101 Shown

Model Number	COMPARE										
	Caliber	Capacity	Material/Finish	Grips	Sights	Barrel Length	Overall Length	Weight	Twist	Suggested Retail	
5107	357 Mag	6	Alloy Steel/Blued	Hardwood	Blade Front, Integral Rear	4.62"	10.25"	43 oz.	1:16"	\$829.00	
5106	357 Mag	6	Alloy Steel/Blued	Hardwood	Blade Front, Integral Rear	5.50"	11.12"	44 oz.	1:16"	\$829.00	
5102	45 Colt	6	Alloy Steel/Blued	Hardwood	Blade Front, Integral Rear	4.62"	10.25"	40 oz.	1:16"	\$829.00	
5101	45 Colt	6	Alloy Steel/Blued	Hardwood	Blade Front, Integral Rear	5.50"	11.12"	40 oz.	1:16"	\$829.00	

NEW VAQUERO with High-Gloss Stainless Finish



Model 5104 Shown

Model Number	COMPARE										
	Caliber	Capacity	Material/Finish	Grips	Sights	Barrel Length	Overall Length	Weight	Twist	Suggested Retail	
5109	357 Mag	6	Stainless Steel/High-Gloss Stainless	Hardwood	Blade Front, Integral Rear	4.62"	10.25"	43 oz.	1:16"	\$829.00	
5108	357 Mag	6	Stainless Steel/High-Gloss Stainless	Hardwood	Blade Front, Integral Rear	5.50"	11.12"	44 oz.	1:16"	\$829.00	
5105	45 Colt	6	Stainless Steel/High-Gloss Stainless	Hardwood	Blade Front, Integral Rear	4.62"	10.25"	40 oz.	1:16"	\$829.00	
5104	45 Colt	6	Stainless Steel/High-Gloss Stainless	Hardwood	Blade Front, Integral Rear	5.50"	11.12"	41 oz.	1:16"	\$829.00	

BISLEY™ NEW VAQUERO



Model 5129 Shown



Simulated Ivory Grips

Bisley-Style Hammer

Model Number	COMPARE										
	Caliber	Capacity	Material/Finish	Grips	Sights	Barrel Length	Overall Length	Weight	Twist	Suggested Retail	
5130	357 Mag	6	Stainless Steel/High-Gloss Stainless	Simulated Ivory	Blade Front, Integral Rear	5.50"	11.12"	45 oz.	1:16"	\$899.00	
5129	45 Colt	6	Stainless Steel/High-Gloss Stainless	Simulated Ivory	Blade Front, Integral Rear	5.50"	11.12"	41 oz.	1:16"	\$899.00	

SASS® NEW VAQUERO Two-Gun Set



Model 5133 Shown



Black Checkered Grips with SASS® Logo

Montado-Style Hammer

Consecutive Serial Numbers with "SASS" Prefix, Shipped Together in Commemorative Case

Model Number	COMPARE										
	Caliber	Capacity	Material/Finish	Grips	Sights	Barrel Length	Overall Length	Weight	Twist	Suggested Retail	
5133	357 Mag	6	Stainless Steel/High-Gloss Stainless	Black Checkered	Blade Front, Integral Rear	4.62"	10.25"	45 oz.	1:16"	\$1,699.00 (Two-Gun Set)	
5134	45 Colt	6	Stainless Steel/High-Gloss Stainless	Black Checkered	Blade Front, Integral Rear	5.50"	11.12"	40 oz.	1:16"	\$1,699.00 (Two-Gun Set)	

NEW MODEL SUPER BLACKHAWK®

FEATURES

- Traditional western-style, hand-filling grip has long been acknowledged as one of the most comfortable and natural-pointing of any grip style.
- Transfer bar mechanism and loading gate interlock provide an unparalleled measure of security against accidental discharge.
- Durable coil springs throughout for maximum reliability.
- Fixed ramp front sight and adjustable rear sight.
- Integral mounts, machined directly on the solid-steel barrel rib of Hunter models, provide a stable mounting surface for scope rings, eliminating a potential source of looseness and inaccuracy in the field (scope rings included).
- Chambered in the powerful .44 Magnum, these models also accept factory .44 Special cartridges, which deliver superb accuracy and milder recoil.
- Cold hammer-forged barrel results in ultra-precise rifling that provides exceptional accuracy and longevity.

ORIGINAL "OLD MODEL" (PRE-1973) OWNERS: SEE INSIDE BACK COVER FOR AN IMPORTANT **FREE SAFETY OFFER** FROM RUGER!



Transfer Bar Mechanism



Traditional Western-Style, Hand-Filling Grip



Chambered for .44 Magnum and .44 Special Cartridges



Ramp Front and Adjustable Rear Sights

NEW MODEL SUPER BLACKHAWK® HUNTER



Ramp Front with Red Insert and Adjustable Rear Sights



Integral Scope Mounts Provide Stable Surface for Mounting Included Scope Rings

Model Number	Caliber	Capacity	Material/Finish	Grips	Sights	Barrel Length	Overall Length	Weight	Twist	Suggested Retail
0860	44 Rem Mag	6	Stainless Steel/Satin Stainless	Black Laminate	Ramp Front, Adjustable Rear	7.50"	13.63"	52 oz.	1:20"	\$959.00

NEW MODEL SUPER BLACKHAWK® BISLEY™ HUNTER



Bisley-Style Black Laminate Grips



Ramp Front with Red Ramp Insert and Adjustable Rear Sights



Integral Scope Mounts Provide Stable Surface for Mounting Included Scope Rings

Model Number	Caliber	Capacity	Material/Finish	Grips	Sights	Barrel Length	Overall Length	Weight	Twist	Suggested Retail
0862	44 Rem Mag	6	Stainless Steel/Satin Stainless	Black Laminate	Ramp Front, Adjustable Rear	7.50"	13.12"	52 oz.	1:20"	\$959.00

NEW MODEL SUPER BLACKHAWK®



Model 0813 Shown



Blued or Stainless Finish

Model Number	Caliber	Capacity	COMPARE		Grips	Sights	Barrel Length	Overall Length	Weight	Twist	Suggested Retail
			Material/Finish	Material/Finish							
0813	44 Rem Mag	6	Alloy Steel/Blued	Alloy Steel/Blued	Hardwood	Ramp Front, Adjustable Rear	4.62"	10.50"	45 oz.	1:20"	\$829.00
0814	44 Rem Mag	6	Stainless Steel/Satin Stainless	Stainless Steel/Satin Stainless	Hardwood	Ramp Front, Adjustable Rear	4.62"	10.50"	45 oz.	1:20"	\$829.00

NEW MODEL SUPER BLACKHAWK® with Fluted Cylinder



Model 0811 Shown



Blued or Stainless Finish



Fluted Cylinder

Model Number	Caliber	Capacity	COMPARE		Grips	Sights	Barrel Length	Overall Length	Weight	Twist	Suggested Retail
			Material/Finish	Material/Finish							
0810	44 Rem Mag	6	Alloy Steel/Blued	Alloy Steel/Blued	Hardwood	Ramp Front, Adjustable Rear	5.50"	11.38"	45 oz.	1:20"	\$829.00
0811	44 Rem Mag	6	Stainless Steel/Satin Stainless	Stainless Steel/Satin Stainless	Hardwood	Ramp Front, Adjustable Rear	5.50"	11.38"	45 oz.	1:20"	\$829.00

NEW MODEL SUPER BLACKHAWK® with Square Back Trigger Guard



Model 0804 Shown



Blued or Stainless Finish



Square Back Trigger Guard

Model Number	Caliber	Capacity	COMPARE		Grips	Sights	Barrel Length	Overall Length	Weight	Twist	Suggested Retail
			Material/Finish	Material/Finish							
0802	44 Rem Mag	6	Alloy Steel/Blued	Alloy Steel/Blued	Hardwood	Ramp Front, Adjustable Rear	7.50"	13.38"	48 oz.	1:20"	\$829.00
0807	44 Rem Mag	6	Alloy Steel/Blued	Alloy Steel/Blued	Hardwood	Ramp Front, Adjustable Rear	10.50" (Target)	16.38"	55 oz.	1:20"	\$829.00
0804	44 Rem Mag	6	Stainless Steel/Satin Stainless	Stainless Steel/Satin Stainless	Hardwood	Ramp Front, Adjustable Rear	7.50"	13.38"	48 oz.	1:20"	\$829.00
0806	44 Rem Mag	6	Stainless Steel/Satin Stainless	Stainless Steel/Satin Stainless	Hardwood	Ramp Front, Adjustable Rear	10.50" (Target)	16.38"	55 oz.	1:20"	\$859.00

RUGER® NEW MODEL BLACKHAWK®

FEATURES

- Traditional western-style, hand-filling grip has long been acknowledged as one of the most comfortable and natural pointing of any grip style.
- Target-grade accuracy with ramp front and adjustable rear sights.
- Transfer bar mechanism and loading gate interlock provide an unparalleled measure of security against accidental discharge.
- Variety of calibers, barrel lengths, grips, finishes and weights guarantees a model to meet the needs of today's single-action shooters.
- Cold hammer-forged barrel results in ultra-precise rifling that provides exceptional accuracy and longevity.
- .357 Magnum models are dual chambered to also accept factory .38 Special cartridges.

ORIGINAL "OLD MODEL" (PRE-1973) OWNERS: SEE INSIDE BACK COVER FOR AN IMPORTANT **FREE SAFETY OFFER** FROM RUGER!



Variety of Calibers, Barrel Lengths, Grips and Finishes Available



Transfer Bar Mechanism



Target-Grade Accuracy



Traditional Western-Style, Hand-Filling Grip

NEW MODEL BLACKHAWK® with Blued Finish



Model 0505 Shown

Model Number	COMPARE										
	Caliber	Capacity	Material/Finish	Grips	Sights	Barrel Length	Overall Length	Weight	Twist	Suggested Retail	
0505	30 Carb	6	Alloy Steel/Blued	Black, Checkered, Hard-Rubber	Ramp Front, Adjustable Rear	7.50"	13.38"	46 oz.	1:20"	\$669.00	
0306	357 Mag	6	Alloy Steel/Blued	Black, Checkered, Hard-Rubber	Ramp Front, Adjustable Rear	4.62"	10.50"	42 oz.	1:16"	\$669.00	
0316	357 Mag	6	Alloy Steel/Blued	Black, Checkered, Hard-Rubber	Ramp Front, Adjustable Rear	6.50"	12.38"	45 oz.	1:16"	\$669.00	
0405	41 Rem Mag	6	Alloy Steel/Blued	Black, Checkered, Hard-Rubber	Ramp Front, Adjustable Rear	4.62"	10.50"	38 oz.	1:20"	\$669.00	
0406	41 Rem Mag	6	Alloy Steel/Blued	Black, Checkered, Hard-Rubber	Ramp Front, Adjustable Rear	6.50"	12.38"	41 oz.	1:20"	\$669.00	
0445	45 Colt	6	Alloy Steel/Blued	Black, Checkered, Hard-Rubber	Ramp Front, Adjustable Rear	4.62"	10.50"	39 oz.	1:16"	\$669.00	
0455	45 Colt	6	Alloy Steel/Blued	Black, Checkered, Hard-Rubber	Ramp Front, Adjustable Rear	7.50"	13.38"	42 oz.	1:16"	\$669.00	
0465	45 Colt	6	Alloy Steel/Blued	Black, Checkered, Hard-Rubber	Ramp Front, Adjustable Rear	5.50"	11.38"	40 oz.	1:16"	\$669.00	

NEW MODEL BLACKHAWK® with Satin Stainless Finish



Model 0319 Shown

Model Number	Caliber	Capacity	Material/Finish	Grips	Sights	COMPARE				
						Barrel Length	Overall Length	Weight	Twist	Suggested Retail
0309	357 Mag	6	Stainless Steel/Satin Stainless	Hardwood	Ramp Front, Adjustable Rear	4.62"	10.50"	46 oz.	1:16"	\$799.00
0319	357 Mag	6	Stainless Steel/Satin Stainless	Hardwood	Ramp Front, Adjustable Rear	6.50"	12.38"	48 oz.	1:16"	\$799.00

NEW MODEL BLACKHAWK® CONVERTIBLE



Model 0318 Shown



Includes Two Cylinders That Can Be Interchanged Without the Use of Tools

Model Number	COMPARE										
	Caliber	Capacity	Material/Finish	Grips	Sights	Barrel Length	Overall Length	Weight	Twist	Suggested Retail	
0308	357 Mag/9mm Luger	6	Alloy Steel/Blued	Black, Checkered, Hard-Rubber	Ramp Front, Adjustable Rear	4.62"	10.50"	42 oz.	1:16"	\$749.00	
0318	357 Mag/9mm Luger	6	Alloy Steel/Blued	Black, Checkered, Hard-Rubber	Ramp Front, Adjustable Rear	6.50"	12.38"	45 oz.	1:16"	\$749.00	
0446	45 Colt/45 Auto	6	Alloy Steel/Blued	Black, Checkered, Hard-Rubber	Ramp Front, Adjustable Rear	4.62"	10.50"	39 oz.	1:16"	\$749.00	
0463	45 Colt/45 Auto	6	Alloy Steel/Blued	Black, Checkered, Hard-Rubber	Ramp Front, Adjustable Rear	5.50"	11.38"	40 oz.	1:16"	\$749.00	

NEW MODEL SINGLE-SIX® FAMILY

FEATURES

- Windage- and elevation-adjustable rear sights (available on most models) help put you on target and keep you there.
- Chambered for affordable rimfire shooting.
- Transfer bar mechanism and loading gate interlock provide an unparalleled measure of security against accidental discharge.
- Cold hammer-forged barrel results in ultra-precise rifling that provides exceptional accuracy and longevity.

ORIGINAL "OLD MODEL" (PRE-1973) SINGLE-SIX® OWNERS:
SEE INSIDE BACK COVER FOR AN IMPORTANT **FREE SAFETY OFFER** FROM RUGER!



Available in a Variety of Sight, Grip and Finish Configurations



Cold Hammer-Forged Barrel



Transfer Bar Mechanism



Available in Multiple Calibers



RUGER NEW MODEL SINGLE-SIX® FAMILY

SINGLE-TEN®

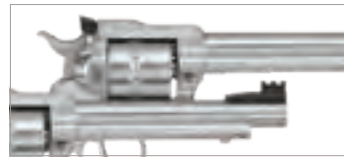

Williams™ Adjustable Fiber Optic Sights

Model Number	Caliber	Capacity	Material/Finish	Grips	Sights	Barrel Length	Overall Length	Weight	Twist	Suggested Retail
8100	22 LR	10	Stainless Steel/Satin Stainless	Hardwood Gunfighter	Williams™ Adjustable Fiber Optic	5.50"	11"	38 oz.	1:14"	\$699.00

SINGLE-NINE®



Williams™ Adjustable Fiber Optic Sights



6.50" Barrel Helps the .22 WMR Cartridge Reach its Fullest Potential

Model Number	Caliber	Capacity	Material/Finish	Grips	Sights	Barrel Length	Overall Length	Weight	Twist	Suggested Retail
8150	22 WMR	9	Stainless Steel/Satin Stainless	Hardwood Gunfighter	Williams™ Adjustable Fiber Optic	6.50"	12"	39 oz.	1:14"	\$699.00

NEW MODEL SINGLE-SIX® in .17 HMR



Ramp Front and Adjustable Rear Sights

Model Number	Caliber	Capacity	Material/Finish	Grips	Sights	Barrel Length	Overall Length	Weight	Twist	Suggested Retail
0661	17 HMR	6	Alloy Steel/Blued	Black, Checkered, Hard-Rubber	Ramp Front, Adjustable Rear	6.50"	12"	35 oz.	1:7"	\$629.00

NEW MODEL SINGLE-SIX® HUNTER



Bead Front and Adjustable Rear Sights



Extra Cylinder Allows Shooters to Easily Change from Shooting .22 LR to .22 WMR



Integral Scope Mounts Provide Stable Surface for Mounting Included Scope Rings

Model Number	Caliber	Capacity	Material/Finish	Grips	Sights	Barrel Length	Overall Length	Weight	Twist	Suggested Retail
0662	22 LR/22 WMR	6	Stainless Steel/Satin Stainless	Black Laminate	Bead Front, Adjustable Rear	7.50"	13"	45 oz.	1:14"	\$879.00

NEW MODEL SINGLE-SIX® CONVERTIBLE



Model 0625 Shown



Blued or Stainless Finish

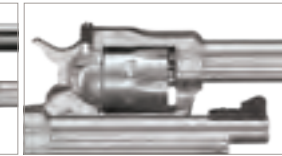

Ramp Front and Adjustable Rear Sights



Extra Cylinder Allows Shooters to Easily Change from Shooting .22 LR to .22 WMR

Model Number	Caliber	Capacity	COMPARE			Barrel Length	Overall Length	Weight	Twist	Suggested Retail
			Material/Finish	Grips	Sights					
0625	22 LR/22 WMR	6	Stainless Steel/Satin Stainless	Hardwood	Ramp Front, Adjustable Rear	5.50"	11"	39 oz.	1:14"	\$699.00
0626	22 LR/22 WMR	6	Stainless Steel/Satin Stainless	Hardwood	Ramp Front, Adjustable Rear	6.50"	12"	40 oz.	1:14"	\$699.00
0623	22 LR/22 WMR	6	Alloy Steel/Blued	Black, Checkered, Hard-Rubber	Ramp Front, Adjustable Rear	4.62"	10.25"	32 oz.	1:14"	\$629.00
0621	22 LR/22 WMR	6	Alloy Steel/Blued	Black, Checkered, Hard-Rubber	Ramp Front, Adjustable Rear	5.50"	11"	33 oz.	1:14"	\$629.00
0622	22 LR/22 WMR	6	Alloy Steel/Blued	Black, Checkered, Hard-Rubber	Ramp Front, Adjustable Rear	6.50"	12"	35 oz.	1:14"	\$629.00
0624	22 LR/22 WMR	6	Alloy Steel/Blued	Black, Checkered, Hard-Rubber	Ramp Front, Adjustable Rear	9.50"	15"	39 oz.	1:14"	\$629.00

NEW MODEL SINGLE-SIX® CONVERTIBLE with Fixed Sights



Blade Front and Integral Rear Sights



Extra Cylinder Allows Shooters to Easily Change from Shooting .22 LR to .22 WMR

Model Number	Caliber	Capacity	Material/Finish	Grips	Sights	Barrel Length	Overall Length	Weight	Twist	Suggested Retail
0629	22 LR/22 WMR	6	Alloy Steel/Blued	Black, Checkered, Hard-Rubber	Blade Front, Integral Rear	5.50"	11"	33 oz.	1:14"	\$699.00

FEATURES

- Decorative, unfluted cylinder displays a rollmark with a bear and cougar design.
- Classic styling and one-piece frame are reminiscent of Civil War-era Remington® revolvers.
- Transfer bar mechanism and loading gate interlock provide an unparalleled measure of security against accidental discharge.
- Lightweight and accurate with blade front and integral notch rear sights.
- Cold hammer-forged barrel results in ultra-precise rifling that provides exceptional accuracy and longevity.

ORIGINAL BEARCAT® AND SUPER BEARCAT™ OWNERS: SEE INSIDE BACK COVER FOR AN IMPORTANT **FREE SAFETY OFFER** FROM RUGER!



New Bearcat®
(Model 0912)



New Bearcat® with Satin Stainless Finish
(Model 0913)



Model Number	Caliber	Capacity	COMPARE							
			Material/Finish	Grips	Sights	Barrel Length	Overall Length	Weight	Twist	Suggested Retail
0912	22 LR	6	Alloy Steel/Blued	Hardwood	Blade Front, Integral Rear	4.20"	9"	24 oz.	1:16"	\$639.00
0913	22 LR	6	Stainless Steel/Satin Stainless	Hardwood	Blade Front, Integral Rear	4.20"	9"	24 oz.	1:16"	\$689.00



Decorative Unfluted Cylinder



Lightweight and Accurate



Transfer Bar Mechanism



Cold Hammer-Forged Barrel



Classic Styling and One-Piece Frame



22 CHARGER™

FEATURES

- Cold hammer-forged barrel results in ultra-precise rifling that provides exceptional accuracy and longevity.
- Features a standard A2-style grip that can be easily replaced with any AR-style grip.
- Factory-installed Picatinny rail provides ample room for scopes and red-dot sights.
- Includes one, 15-round, BX-15® magazine, which is the perfect length when shooting with the included bipod prone or from the bench.
- Included adjustable bipod offers rock-steady sighting.
- Threaded barrel features a 1/2"-28 thread pattern that accepts most suppressors, flash hiders and the factory-installed thread protector.
- Takedown model quickly and easily breaks down into two sections for convenient storage and transport.



Model Number	Caliber	Capacity	Material/Finish	Stock	COMPARE		Barrel Length	Overall Length	Weight**	Twist	Suggested Retail
					Stock Option						
4923*	22 LR	15	Alloy Steel/Matte Black	Black Polymer	Standard		10"	19.25"	3.1 lbs.	1:16"	\$309.00
4924*	22 LR	15	Alloy Steel/Matte Black	Black Polymer	Takedown		10"	19.25"	3.2 lbs.	1:16"	\$419.00



Adjustable Bipod for Rock-Steady Sighting



Takedown Model is Easily Separated and Reassembled



Includes a 15-Round, BX-15® Magazine



Standard A2-Style Pistol Grip



Factory-Installed Picatinny Rail



* Some firearms may not be available in all states and locales due to laws limiting magazine capacity or other feature-based restrictions. Please check with your local law enforcement agency prior to purchasing this firearm to verify that it may legally be purchased and/or possessed in your particular state and locale. ** Without magazine and bipod.



10/22®

For over 50 years, the ubiquitous **10/22®** has been America's favorite .22 rifle. With proven performance, a legendary action and a renowned, reliable rotary magazine, the 10/22® has inspired a loyal following for over half a century.



10/22®

22
LR

ONE CALIBER

FIFTEEN MODELS

CARBINE

COMPACT

SPORTER

TACTICAL

TARGET LITE

TAKEDOWN

TAKEDOWN LITE

NEW 10/22® Carbine with GO Wild® Camo Rock-Star® Stock (Model 31113)

10/22® Target Lite (Model 21186)

FEATURES

- This legendary action is a tried and true Ruger design that ensures consistent, reliable performance.
- Detachable 10-round rotary magazine features a unique rotor to separate cartridges and provide reliable feeding.
- Easy-to-use, prominent magazine release provides smooth, no-fuss removal of the flush-mounted magazine.
- Positive, push-button, cross-bolt manual safety.
- Combination scope base adapter for both Weaver-style and .22 tip-off scope mounts included.



Detachable 10-Round Rotary Magazine



Easy-to-Use, Prominent Magazine Release



Combination Scope Base Adapter Included



Positive, Push-Button, Cross-Bolt Manual Safety



10/22® CARBINE



Model 1103 Shown

Model 21194 Ships with Factory-Installed Weaver™ 3-9x40 Scope and Hard Case

Gold Bead Front and Adjustable, Folding Rear Sights

Model 31128 Ships with Spinning Target and Hard Case

Model Number	Caliber	Capacity	COMPARE		Sights	Barrel Length	Overall Length	Weight	Length of Pull	Twist	Suggested Retail
			Barrel Material/Finish	Stock							
1103	22 LR	10	Alloy Steel/Satin Black	Hardwood	Gold Bead Front, Adjustable Rear	18.50"	37"	5 lbs.	13.50"	1:16"	\$309.00
1151	22 LR	10	Alloy Steel/Satin Black	Black Synthetic	Gold Bead Front, Adjustable Rear	18.50"	37"	5 lbs.	13.50"	1:16"	\$309.00
21194	22 LR	10	Alloy Steel/Satin Black	Black Synthetic	Gold Bead Front, Adjustable Rear (3-9x40 Scope Included)	18.50"	37"	5.6 lbs.	13.50"	1:16"	\$399.00
1256	22 LR	10	Stainless Steel/Satin Stainless	Black Synthetic	Gold Bead Front, Adjustable Rear	18.50"	37"	5 lbs.	13.50"	1:16"	\$339.00
NEW 31128	22 LR	10	Alloy Steel/Satin Black	Hardwood	Gold Bead Front, Adjustable Rear	18.50"	37"	5 lbs.	13.50"	1:16"	\$399.00

10/22® CARBINE with GO Wild® Camo Rock-Star® Stock



NEW

1/2"-28 Threaded Muzzle Fitted with Thread Cap

GO Wild® Camo Rock-Star® Stock

Ships with Soft-Sided 10/22® Rifle Case

Model Number	Caliber	Capacity	Barrel Material/Finish	Stock	Sights	Barrel Length	Overall Length	Weight	Length of Pull	Twist	Suggested Retail
NEW 31113*	22 LR	10	Alloy Steel/Satin Black	GO Wild® Camo Rock-Star®	Gold Bead Front, Adjustable Rear	18.50"	37"	5 lbs.	13.50"	1:16"	\$399.00

10/22® COMPACT



NEW

Ruger® Modular Stock System with Low Comb Compact Length of Pull Module Installed

Fiber Optic Front and Adjustable Fiber Optic Rear Sights

Model Number	Caliber	Capacity	Barrel Material/Finish	Stock	Sights	Barrel Length	Overall Length	Weight	Length of Pull	Twist	Suggested Retail
NEW 31114	22 LR	10	Alloy Steel/Satin Black	Black Synthetic	Fiber Optic Front, Adjustable Fiber Optic Rear	16.12"	34"	4.6 lbs.	12.50"	1:16"	\$309.00

10/22® TACTICAL



Factory-Installed Flash Suppressor with 1/2"-28 Thread Pattern

Contoured Buttplate on Black Synthetic Stock

Model Number	Caliber	Capacity	Barrel Material/Finish	Stock	Sights	Barrel Length	Overall Length	Weight	Length of Pull	Twist	Suggested Retail
1261*	22 LR	10	Alloy Steel/Satin Black	Black Synthetic	None	16.12"	36.25"	4.3 lbs.	13.50"	1:16"	\$359.00

10/22® SPORTER



Gold Bead Front and Adjustable, Folding Rear Sights

Flat Buttplate with Rubber Buttpad and Sling Swivels on American Walnut Stock

Model Number	Caliber	Capacity	Barrel Material/Finish	Stock	Sights	Barrel Length	Overall Length	Weight	Length of Pull	Twist	Suggested Retail
1102	22 LR	10	Alloy Steel/Satin Black	American Walnut	Gold Bead Front, Adjustable Rear	18.50"	37"	5.2 lbs.	13.88"	1:16"	\$419.00

10/22® TARGET LITE



NEW

Model 21185 Shown

1/2"-28 Threaded Barrel Tensioned in Black Anodized Aluminum Alloy Barrel Sleeve

Light, Crisp BX-Trigger®

Laminate Thumbhole Stock with Adjustable Length of Pull

Model Number	Caliber	Capacity	Barrel Material/Finish	COMPARE		Sights	Barrel Length	Overall Length	Weight	Length of Pull	Twist	Suggested Retail
				Stock	Sights							
21186*	22 LR	10	Alloy Steel/Satin Black	Black Laminate with Thumbhole	None	16.13"	35.25"	5 lbs.	13.75"	1:16"	\$649.00	
NEW 21185*	22 LR	10	Alloy Steel/Satin Black	Red and Black Laminate with Thumbhole	None	16.13"	35.25"	5 lbs.	13.75"	1:16"	\$649.00	

* Some rifles may not be available in all states and locales due to laws limiting magazine capacity or other feature-based restrictions. Please check with your local law enforcement agency prior to purchasing this firearm to verify that it may legally be purchased and/or possessed in your particular state and locale.

10/22 TAKEDOWN®

FEATURES

- Easy takedown enables quick separation of the barrel from the action for ease of transport and storage. Takedown is as simple as locking the bolt back and verifying that the rifle is unloaded, pushing a recessed lever, twisting the subassemblies and pulling them apart.
- Simple reassembly allows for a secure connection of the barrel and action and returns the firearm to zero, even when receiver-mounted optics are used, ensuring consistent accuracy, shot after shot.
- Detachable 10-round rotary magazine features a unique rotor to separate cartridges and provide reliable feeding.
- This legendary action is a tried and true Ruger design that ensures consistent, reliable performance.
- Easy-to-use, prominent magazine release provides smooth, no-fuss removal of the flush-mounted magazine.
- Positive, push-button, cross-bolt manual safety.
- Combination scope base adapter for both Weaver-style and .22 tip-off scope mounts included.
- Heat-stabilized, glass-filled, polymer trigger housing assembly is precision-made of high-tech material for improved manufacturing tolerances, impact and abrasion resistance and unmatched ability to withstand the elements.
- Precision-rifled, cold hammer-forged barrel.
- Also includes: convenient carry-case.



Recessed Locking Lever



Detachable 10-Round Rotary Magazine



Easy-to-Use, Prominent Magazine Release



Positive, Push-Button, Cross-Bolt Manual Safety

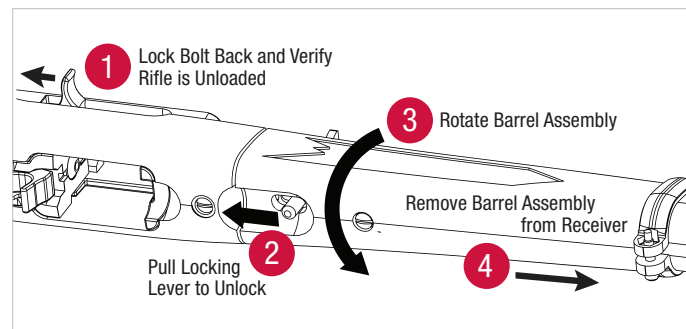

Takedown Enables Quick and Easy Separation of the Barrel from the Action

10/22 TAKEDOWN®



Model 11100 Shown

Gold Bead Front and Adjustable Rear Sights

Clear Matte or Satin Black Finish

Model Number	Caliber	Capacity	COMPARE		Sights	Barrel Feature	Thread Pattern	Barrel Length	Overall Length	Weight	Length of Pull	Twist	Suggested Retail
			Barrel Material/Finish	Stock									
11100	22 LR	10	Stainless Steel/Satin Stainless	Black Synthetic	Gold Bead Front, Adjustable Rear	Standard	-	18.50"	37"	4.6 lbs.	13.87"	1:16"	\$439.00
11112*	22 LR	10	Alloy Steel/Satin Black	Black Synthetic	Gold Bead Front, Adjustable Rear	Threaded with Flash Suppressor	1/2"-28	16.40"	36.75"	4.6 lbs.	13.87"	1:16"	\$459.00

10/22 TAKEDOWN® with Fluted .920" Diameter Barrel



Ruger® Modular Stock System with Low Comb, Standard Length of Pull Module Installed (Ships with Additional High Comb, Standard Length of Pull Module)

.920" Diameter Barrel is Fluted for Weight Reduction

Model Number	Caliber	Capacity	Barrel Material/Finish	Stock	Sights	Barrel Feature	Thread Pattern	Barrel Length	Overall Length	Weight	Length of Pull	Twist	Suggested Retail
21133*	22 LR	10	Alloy Steel/Satin Black	Black Synthetic	None	Threaded, Fluted .920" Diameter	1/2"-28	16.12"	34.62"	5.3 lbs.	13.87"	1:16"	\$629.00

10/22 TAKEDOWN® LITE



Ruger® Modular Stock System with Low Comb, Standard Length of Pull Module Installed (Ships with Additional High Comb, Standard Length of Pull Module)

Alloy Steel Barrel Tensioned in a 6061-T6 Aluminum Alloy, Ventilated Sleeve

Model Number	Caliber	Capacity	Barrel Material/Finish	Stock	Sights	Barrel Feature	Thread Pattern	Barrel Length	Overall Length	Weight	Length of Pull	Twist	Suggested Retail
21152*	22 LR	10	Alloy Steel/Satin Black	Black Synthetic	None	Threaded, Tensioned in Aluminum Sleeve	1/2"-28	16.12"	34.62"	4.5 lbs.	13.87"	1:16"	\$659.00

* Some rifles may not be available in all states and locales due to laws limiting magazine capacity and feature-based restrictions. Please check with your local law enforcement agency prior to purchasing this firearm to verify that it may legally be purchased and/or possessed in your particular state and locale.



SILENT-SR® ISB

Offering top-tier sound reduction, the **Silent-SR® Integrally Suppressed Barrel** features best-in-class materials and an advanced design resulting in a lightweight, compact package.



Rifle Not Included

SILENT-SR® ISB



22
LR

REDUCES SOUND PRESSURE LEVELS OF .22 LR TO
AN AVERAGE OF 113.2 dB
WITH STANDARD VELOCITY AMMUNITION.

THE SILENT-SR® ISB IS COMPATIBLE WITH A HOST OF RUGER® FIREARMS

- | | | | |
|----------------------|-----------------|--|----------------------|
| 22 Charger™ Takedown | 10/22 Takedown® | 10/22 Takedown® with .920" Diameter Barrel | 10/22 Takedown® Lite |
|----------------------|-----------------|--|----------------------|

Silent-SR® ISB
(Model 19001)

FEATURES

- Reduces sound pressure levels of .22 LR to an average of 113.2 dB with standard velocity ammunition.
- Lightweight for balance and portability. Once installed on the firearm, the center of gravity is close to the receiver, making it easy to maneuver and shoot.
- Easy to disassemble and clean. All internal components seal together to keep the byproducts of combustion away from the tube. A single screw retains the baffles and cap within the sleeve and doubles as a removal tool. The included 5/32" hex key tool allows the integrally suppressed barrel to be completely disassembled for cleaning.
- Sleeve surrounding the 17-4 stainless baffles is matched to the forend for a clean, but distinctive, appearance.
- Stainless steel barrel, baffles and front cap were chosen for maximum strength and serviceability. The aluminum sleeve is permanently attached to the barrel to minimize weight and maintain a minimum overall length.



For additional information on National Firearms Act (NFA) item restrictions, visit: RUGER.COM/NFA



Easy Disassembly for Cleaning



Using the Provided Disassembly Tool, Remove the Barrel Cap



Slide the Entire Stack of Baffles Out of the Barrel



Snap Apart Each Part of the Baffle Stack



Model Number	Caliber	Material/Finish	Effective Barrel Length	Legal Barrel Length	Weight	Suggested Retail
19001*	22 LR	17-4 Stainless and Aluminum/Cerakote™	10.62"	16.12"	2.6 lbs.	\$629.00

* Sound suppressors are not available in all states and locales due to laws restricting their ownership and use. Prior to purchasing, please check your state and local regulations to verify that you may legally possess a suppressor.





PC CARBINE™

Practical and versatile, the Pistol Caliber Carbine is ideal for any shooter, from novice to experienced. Built to excel in a variety of roles, from plinking or competition to home or personal defense, the **PC Carbine™** is highly configurable, yet compact, making it the perfect, portable companion to match with a variety of pistols.



PC Carbine™
(Model 19100)

PC CARBINE™



9mm
LUGER



MULTIPLE MAGAZINE COMPATIBILITY

FEATURES

- Interchangeable magazine wells for use of common Ruger® and Glock® magazines. Ships with SR-Series™ and Security-9® pistol magazine well installed and an additional magazine well accepting Glock® magazines is included*. Ruger American® Pistol magazine wells are available at ShopRuger.com.
- Easy takedown enables quick separation of the barrel/forend assembly from the action for ease of transportation and storage. Takedown is as simple as locking the bolt back and verifying that the rifle is unloaded, pushing a recessed lever, twisting the subassemblies and pulling them apart.
- Dead blow action features a custom tungsten dead blow weight that shortens bolt travel and reduces felt recoil and muzzle rise. Bolt is machined from heat treated, chrome-moly steel to ensure strength, structural integrity and durability.
- Reversible magazine release and reversible charging handle to support ambidextrous use or one-handed control manipulation while maintaining a proper firing grip†.
- Cold hammer-forged, chrome-moly steel barrel with ultra-precise rifling provides exceptional accuracy and longevity. The heavy-contour barrel provides consistent accuracy, while barrel fluting sheds unnecessary weight and allows for quick handling.
- 1/2"-28 threaded barrel with included thread protector allows for use of standard muzzle accessories (excludes modl 19101).
- Accurate sighting system with adjustable ghost ring rear aperture sight and non-glare, protected blade front sight.
- Soft rubber buttpad with spacers allows the rifle to be properly sized for different shooters or varying levels of outerwear or defensive gear (three, 1/2" spacers included).
- Durable, glass-filled nylon synthetic stock features sling swivel studs for rapid sling attachment and forward mounted accessory rail to allow for a variety of under-barrel accessories such as lights or lasers. The grip features a proprietary texture for enhanced control.
- Light, crisp trigger pull with minimal overtravel and positive reset utilizing proven 10/22® trigger components.
- CNC-machined from an aerospace-grade 7075-T6 aluminum billet, the receiver includes an integrated Picatinny rail and is Type III hard-coat anodized for maximum durability.
- Also includes: one SR-Series™ pistol magazine and hex wrenches for rear sight adjustment, buttpad spacer adjustment and charging handle removal.



PC Carbine™
(Model 19100)



Model Number	Caliber	Capacity	Receiver Material/Finish	Stock	Sights	Barrel Feature	Thread Pattern	Barrel Length	Overall Length	Weight	Length of Pull	Twist	Suggested Retail
19100*	9mm Luger	17	Aluminum Alloy/ Type III Hard-Coat Anodized	Black Synthetic	Protected Blade Front/ Adjustable Ghost Ring Rear	Threaded, Fluted	1/2"-28	16.12"	34.37"	6.8 lbs.	12.62"-14.12"	1:10"	\$649.00
19101	9mm Luger	10	Aluminum Alloy/ Type III Hard-Coat Anodized	Black Synthetic	Protected Blade Front/ Adjustable Ghost Ring Rear	Fluted	-	16.12"	34.37"	6.8 lbs.	12.62"-14.12"	1:10"	\$649.00
19102*	9mm Luger	10	Aluminum Alloy/ Type III Hard-Coat Anodized	Black Synthetic	Protected Blade Front/ Adjustable Ghost Ring Rear	Threaded, Fluted	1/2"-28	16.12"	34.37"	6.8 lbs.	12.62"-14.12"	1:10"	\$649.00



Interchangeable Magazine Wells



Easy Takedown Enables Quick Separation of the Barrel/Forend Assembly from the Action



Dead Blow Action to Shorten Bolt Travel and Reduce Felt Recoil and Muzzle Rise



Reversible Magazine Release† and Reversible Charging Handle



Buttpad Spacers Allow for Adjustable Length of Pull



Non-Glare, Protected Blade Front Sight and Adjustable Ghost Ring Rear Aperture Sight



* Some firearms may not be available in all states and locales due to laws limiting magazine capacity or other feature-based restrictions. Please check with your local law enforcement agency prior to purchasing this firearm to verify that it may legally be purchased and/or possessed in your particular state and locale. † Older Glock® magazines that feature only one magazine latch slot may still be used with the PC Carbine™, but the magazine release button must remain on the left side of the rifle as shipped from the factory. The magazine release button should not be reversed when using this type of magazine as the magazine will not properly lock into the magazine well.



AR-556®

A semi-automatic, M4-Style, direct impingement Modern Sporting Rifle, the **AR-556®** offers consumers an affordable, American-made rifle with the rugged reliability they have come to expect from Ruger. Extensively tested during its development, the AR-556® is constructed from top-quality components, including forged 7075-T6 aluminum upper and lower receivers and a cold hammer-forged, chrome-moly steel barrel with M4 feed ramp cuts. With standardized M4/AR components utilized throughout, the AR-556® is readily customizable.



AR-556®



5.56
NATO/
223
REM

450
BUSH-
MASTER

TWO CALIBERS

EIGHT MODELS

AR-556®

AR-556® MPR

FIND THE PERFECT MODERN SPORTING RIFLE FOR YOU AT
RUGER.COM/MSRCOMPARISON

NEW AR-556® MPR in
.450 Bushmaster
(Model 8522)

FEATURES

- Ruger® Rapid Deploy folding rear sight provides windage adjustability and pairs with the A2-style, F-height, elevation-adjustable front sight for a solid, reliable aiming system (excludes model 8525 and AR-lower receivers).
- Made from 7075-T6 hard-coat anodized aluminum forgings, shot-peened and proof-tested 9310 steel bolt, and 8620 steel bolt carrier. The inside diameter of the carrier and gas key are chrome plated and the key is staked for longevity.
- Patented Barrel Nut and Delta Ring allow easy, one-person service of the heat-resistant glass-filled nylon handguard. The design accepts most standard carbine-length handguards. The barrel nut uses a standard wrench.
- Gas block is located at a carbine-length (M4) position for improved balance and handling. Multiple attachment points include a QD socket and bayonet lug for many sling and accessory mounting options. Serrations on the angled face of the gas block provide a low-glare surface.
- Single-stage trigger provides durable and reliable fire control. The enlarged trigger guard is designed to allow for gloved shooting in cold weather (excludes AR-lower receivers).
- Complete rifles are equipped with a cold hammer-forged alloy barrel with 1:8" twist rifling that provides exceptional accuracy with bullets from 35 to 77 grains. M4 feed ramps and 5.56 NATO chamber allows the use of both 5.56 NATO and .223 Rem. ammunition. The barrel and 1/2"-28 Ruger® flash suppressor have a matte black oxide finish to reduce glare and provide corrosion resistance (excludes model 8502).
- Model 8525 features a flat top Picatinny upper receiver and same-plane Picatinny gas block for easy attachment of magnified optics, red-dot or open sights.



A2-Style Front Sight and Ruger® Rapid Deploy Folding Rear Sight (Excludes Model 8525)



16.10" Cold Hammer-Forged Barrel with Ruger® Flash Suppressor



Flat Top Upper Receiver Features a Forward Assist, Dust Cover and Brass Deflector



AR-Lower and AR-Lower Elite Receivers Available for Purchase Separately



AR-556®

AR-556®



Available with Glass-Filled Nylon Handguard or Magpul® MOE® Handguard with Magpul® M-LOK® Slots

Ships with One, 30-Round Magpul® PMAG®

Model Number	Caliber	Capacity	COMPARE		Barrel Length	Overall Length	Height**	Weight	Length of Pull	Thread Pattern	Twist	Suggested Retail
			Stock	Handguard								
8500*	5.56 NATO/223 Rem	30	Black Synthetic, Collapsible	MOE® Handguard with M-LOK® Slots	16.10"	32.25"-35.50"	8"	6.5 lbs.	10.25" - 13.50"	1/2"-28	1:8"	\$799.00
NEW 8515*	5.56 NATO/223 Rem	30	Magpul® MOE® Synthetic, Collapsible	MOE® Handguard with M-LOK® Slots	16.10"	33.10"-36.35"	8"	6.5 lbs.	11.10" - 14.40"	1/2"-28	1:8"	\$849.00

AR-556® Optics Carbine



Flat Top Picatinny Upper Receiver and Same-Plane Picatinny Gas Block

Model Number	Caliber	Capacity	Stock	Barrel Length	Overall Length	Height**	Weight	Length of Pull	Thread Pattern	Twist	Suggested Retail
NEW 8525*	5.56 NATO/223 Rem	30	Black Synthetic, Collapsible	16.10"	32.25"-35.50"	7.20"	6.7 lbs.	10.25" - 13.50"	1/2"-28	1:8"	\$789.00

AR-556® State Compliant



Models 8502 and 8511 Feature a Heavy-Contour Barrel

Model 8502 Features a Fixed Stock and No Bayonet Lug or Flash Suppressor

Ships with One, 10-Round Metal Magazine

Model Number	Caliber	Capacity	COMPARE		Barrel Length	Overall Length	Height**	Weight	Length of Pull	Thread Pattern	Twist	Suggested Retail
			Stock	Handguard								
8502*	5.56 NATO/223 Rem	10	Black Synthetic, Fixed	MOE® Handguard with M-LOK® Slots	16.10"	34.40"	8"	7.1 lbs.	13.50"	-	1:8"	\$799.00
8511*	5.56 NATO/223 Rem	10	Black Synthetic, Collapsible	MOE® Handguard with M-LOK® Slots	16.10"	32.25"-35.50"	8"	6.7 lbs.	10.25" - 13.50"	1/2"-28	1:8"	\$799.00

AR-556® State Compliant with MonsterMan Grip



Featureless, Fixed A2 Stock

MonsterMan Grip

Factory-Installed Thread Protector

Ships with One, 10-Round Metal Magazine

Model Number	Caliber	Capacity	Stock	Barrel Length	Overall Length	Height**	Weight	Length of Pull	Thread Pattern	Twist	Suggested Retail
8513*	5.56 NATO/223 Rem	10	Fixed A2 Stock, MonsterMan Grip	16.10"	32.85"	8"	7.5 lbs.	11.88"	1/2"-28	1:8"	\$849.00

AR-LOWER RECEIVERS



Model 8516 Shown

Stripped AR-Lower Receiver (Model 8506)

Model Number	Material	Finish	Hammer/Trigger Pins	Takedown/Pivot Pins	COMPARE		Trigger	Overall Length	Length of Pull	Height	Suggested Retail	
					Weight	Stock						
8506***	7075 Forged Aluminum	Hard-Coat Anodized	0.154"	0.250"	8.8 oz.	-	-	7.75"	-	4"	\$129.00	
Elite 8516***	7075 Forged Aluminum	Hard-Coat Anodized	0.154"	0.250"	2.2 lbs.	Magpul® MOE SL®	Magpul® MOE®	Elite 452® AR-Trigger	15.63"-19"	11.10"-14.40"	6.75"	\$299.00

* Some rifles may not be available in all states and locales due to laws limiting magazine capacity and feature-based restrictions. Please check with your local law enforcement agency prior to purchasing this firearm to verify that it may legally be purchased and/or possessed in your particular state and locale. ** Without magazine. *** Some states prohibit the purchase of certain firearm receivers. Please check with your local law enforcement agency prior to purchasing this firearm receiver to verify that it may legally be purchased and/or possessed in your particular state and locale.

AR-556® MPR

FEATURES

- Lower receiver is fitted with Magpul® MOE® grip and MOE SL® collapsible buttstock on a Mil-Spec buffer tube.
- Handguard is free-floated for accuracy and the slim profile provides enhanced ergonomics.
- Model 8514 bolt is mil-spec 9310 and is machined and shot peened for strength and durability. To support the large case head of .450 Bushmaster ammunition, the .450 Bushmaster bolt is engineered with tapered lugs and machined from a high-strength superalloy.
- The Ruger® Elite 452® AR-Trigger is a two-stage trigger that offers a smooth, crisp, 4.5 pound trigger pull. It features a full-strength hammer spring for consistent primer ignition and a lightweight hammer that enables a faster lock time for improved accuracy.
- Magpul® M-LOK® accessory attachment slots along the 3:00, 6:00 and 9:00 positions with additional slots on the angled faces near the muzzle.
- Ruger® muzzle brake is a radial port design that significantly reduces felt recoil and muzzle movement. The threaded barrel allows for standard muzzle accessories to be installed.
- Model 8522 features a cold hammer-forged 4140 chrome-moly steel barrel with ultra-precise 5R rifling and black nitrided finish provides exceptional accuracy, longevity and easy cleaning. The heavy barrel profile and 1:16" twist rate maximizes accuracy with bullets ranging from 170 to 260 grains.
- Also includes: one magazine.



Model 8522 Shown

NEW AR-556® MPR in .450 Bushmaster



Model Number	COMPARE Caliber	Capacity	Stock	Handguard Length	Barrel Length	Overall Length	Height**	Weight	Length of Pull	Thread Pattern	Twist	Suggested Retail
8514*	5.56 NATO/223 Rem	30	Magpul® MOE SL® Synthetic, Collapsible	15"	18"	35"- 38.25"	8"	6.8 lbs.	11.10"- 14.40"	1/2"-28	1:8"	\$899.00
NEW 8522*	450 Bushmaster	5	Magpul® MOE SL® Synthetic, Collapsible	15"	18.63"	35.60"- 38.90"	7.30"	7.4 lbs.	11.10"- 14.40"	11/16"-24	1:16"	\$1,099.00



Flat Top Upper Receiver Features a Forward Assist, Dust Cover and Brass Deflector



Lower Receiver Fitted with Magpul® MOE® Grip and MOE SL® Collapsible Buttstock



Two-Stage Ruger® Elite 452® AR-Trigger Offers a Smooth, Crisp, 4.5 Pound Trigger Pull



Magpul® M-LOK® Accessory Attachment Slots Along the 3:00, 6:00 and 9:00 Positions



* Some rifles may not be available in all states and locales due to laws limiting magazine capacity and feature-based restrictions. Please check with your local law enforcement agency prior to purchasing this firearm to verify that it may legally be purchased and/or possessed in your particular state and locale. ** Without magazine.



MINI-14® AND MINI THIRTY®

From the farm and ranch to the deep woods and personal defense, **Mini-14®** and **Mini Thirty®** rifles have been the people's choice. Their shorter barrels and overall length make them favorites in any application where reliability, maneuverability and ease of handling are priorities.



MINI-14® AND MINI THIRTY®



5.56
NATO/
223
REM

300
BLK

762
x39

THREE CALIBERS

SIXTEEN MODELS

MINI-14®
RANCH

MINI-14®
TACTICAL

MINI
THIRTY®

MINI
THIRTY®
TACTICAL

Mini-14® Tactical in
5.56 NATO/.223 Rem.
(Model 5847)

Mini Thirty®
(Model 5806)

MINI-14® AND MINI THIRTY®

FEATURES

- Simple, rugged, Garand-style action with breech bolt locking system, a fixed-piston gas system and self-cleaning moving gas cylinder gives unparalleled reliability under harsh operating conditions.
- Cold hammer-forged barrel results in ultra-precise rifling that provides exceptional accuracy and longevity.
- Integral scope mounts, machined directly on the solid steel receiver, provide a stable mounting surface for included scope rings, eliminating a potential source of looseness and inaccuracy in the field.
- Accurate sighting system with adjustable ghost ring rear aperture sight and a non-glare, protected blade front sight.
- Receiver is drilled and tapped for mounting the included Picatinny rail.
- Also includes: two magazines; Picatinny rail; scope rings.

5.56
NATO/
223
REM

300
BLK

762
x39



Simple, Rugged, Garand-Style Action



Adjustable Ghost Ring Rear Aperture Sight and Non-Glare, Protected Blade Front Sight



Integral Scope Mounts



Cold Hammer-Forged Barrel



RUGER MINI-14® AND MINI THIRTY®

MINI-14® RANCH with Hardwood Stock



Model 5802 Shown

Blued or Matte Stainless Finish Integral Sling Swivels

Model Number	Caliber	COMPARE		Stock	Sights	Barrel Length	Overall Length	Weight	Length of Pull	Twist	Suggested Retail
		Capacity	Material/Finish								
5816*	5.56 NATO/223 Rem	20	Alloy Steel/Blued	Hardwood	Blade Front, Adjustable Rear	18.50"	38"	7 lbs.	13.50"	1:9"	\$1,049.00
5801	5.56 NATO/223 Rem	5	Alloy Steel/Blued	Hardwood	Blade Front, Adjustable Rear	18.50"	38"	7 lbs.	13.50"	1:9"	\$999.00
5802	5.56 NATO/223 Rem	5	Stainless Steel/Matte Stainless	Hardwood	Blade Front, Adjustable Rear	18.50"	38"	7 lbs.	13.50"	1:9"	\$1,069.00

MINI-14® RANCH with Black Synthetic Stock



Model 5817 Shown

Blued or Matte Stainless Finish Integral Sling Swivels

Model Number	Caliber	COMPARE		Stock	Sights	Barrel Length	Overall Length	Weight	Length of Pull	Twist	Suggested Retail
		Capacity	Material/Finish								
5805	5.56 NATO/223 Rem	5	Stainless Steel/Matte Stainless	Black Synthetic	Blade Front, Adjustable Rear	18.50"	37.50"	6.7 lbs.	13"	1:9"	\$1,069.00
5817*	5.56 NATO/223 Rem	20	Stainless Steel/Matte Stainless	Black Synthetic	Blade Front, Adjustable Rear	18.50"	37.50"	6.7 lbs.	13"	1:9"	\$1,139.00
5855	5.56 NATO/223 Rem	5	Alloy Steel/Blued	Black Synthetic	Blade Front, Adjustable Rear	18.50"	37.50"	6.7 lbs.	13"	1:9"	\$999.00

MINI-14® TACTICAL



Model 5847 Shown

Blued or Matte Stainless Finish Factory-Installed Flash Suppressor Integral Sling Swivels

Model Number	Caliber	COMPARE		Stock	Sights	Barrel Length	Overall Length	Thread Pattern	Weight	Length of Pull	Twist	Suggested Retail
		Capacity	Material/Finish									
5847*	5.56 NATO/223 Rem	20	Alloy Steel/Blued	Black Synthetic	Blade Front, Adjustable Rear	16.12"	36.75"	1/2"-28	6.7 lbs.	13"	1:9"	\$1,089.00
5848*	5.56 NATO/223 Rem	5	Alloy Steel/Blued	Black Synthetic	Blade Front, Adjustable Rear	16.12"	36.75"	1/2"-28	6.7 lbs.	13"	1:9"	\$1,089.00
5819*	5.56 NATO/223 Rem	20	Stainless Steel/Matte Stainless	Black Synthetic	Blade Front, Adjustable Rear	16.12"	36.75"	1/2"-28	6.7 lbs.	13"	1:9"	\$1,169.00
5864*	300 BLK	20	Alloy Steel/Blued	Black Synthetic	Blade Front, Adjustable Rear	16.12"	36.25"	5/8"-24	6.7 lbs.	13"	1:7"	\$1,089.00

MINI-14® TACTICAL with Collapsible Folding Stock



ATI Six-Position Collapsible Folding Stock Factory-Installed Flash Suppressor Picatinny Rails

Model Number	Caliber	Capacity	Material/Finish	Stock	Sights	Barrel Length	Overall Length	Thread Pattern	Weight	Length of Pull	Twist	Suggested Retail
5846*	5.56 NATO/223 Rem	20	Alloy Steel/Blued	Black Synthetic, Collapsible/Folding	Blade Front, Adjustable Rear	16.12"	34"-37.75"	1/2"-28	7.2 lbs.	11.88"-15.62"	1:9"	\$1,089.00

MINI THIRTY®

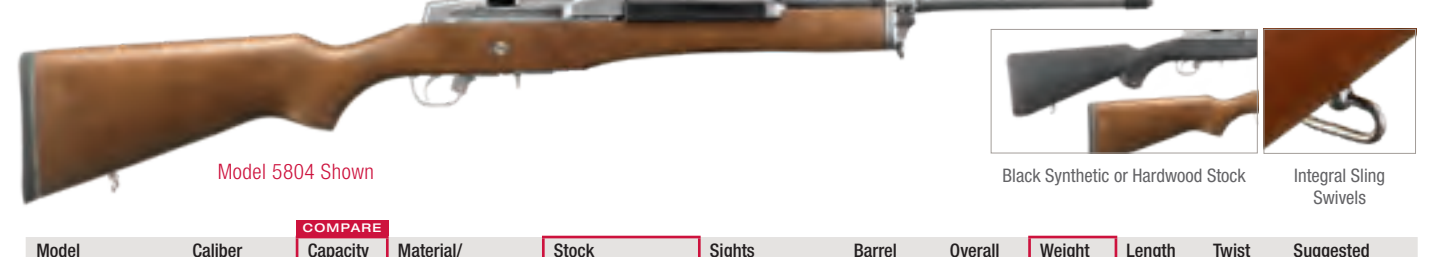

Model 5804 Shown

Black Synthetic or Hardwood Stock Integral Sling Swivels

Model Number	Caliber	COMPARE		Stock	Sights	Barrel Length	Overall Length	Weight	Length of Pull	Twist	Suggested Retail
		Capacity	Material/Finish								
5853*	7.62x39	20	Stainless Steel/Matte Stainless	Black Synthetic	Blade Front, Adjustable Rear	18.50"	37.50"	6.7 lbs.	13"	1:10"	\$1,139.00
5806	7.62x39	5	Stainless Steel/Matte Stainless	Black Synthetic	Blade Front, Adjustable Rear	18.50"	37.50"	6.7 lbs.	13"	1:10"	\$1,069.00
5804	7.62x39	5	Stainless Steel/Matte Stainless	Hardwood	Blade Front, Adjustable Rear	18.50"	37.50"	7 lbs.	13"	1:10"	\$1,069.00

MINI THIRTY® TACTICAL



Model 5854 Shown

Blued or Matte Stainless Finish Factory-Installed Flash Suppressor Integral Sling Swivels

Model Number	Caliber	COMPARE		Stock	Sights	Barrel Length	Overall Length	Thread Pattern	Weight	Length of Pull	Twist	Suggested Retail
		Capacity	Material/Finish									
5854*	7.62x39	20	Alloy Steel/Blued	Black Synthetic	Blade Front, Adjustable Rear	16.12"	36.75"	5/8"-24	6.7 lbs.	13"	1:10"	\$1,089.00
5868*	7.62x39	20	Stainless Steel/Matte Stainless	Black Synthetic	Blade Front, Adjustable Rear	16.12"	36.75"	5/8"-24	6.7 lbs.	13"	1:10"	\$1,169.00

* Some rifles may not be available in all states and locales due to laws limiting magazine capacity and feature-based restrictions. Please check with your local law enforcement agency prior to purchasing this firearm to verify that it may legally be purchased and/or possessed in your particular state and locale.



RUGER PRECISION® RIFLE

Purpose-built to distance itself from the typical long-range rifle, the **Ruger Precision® Rifle** is a highly configurable, in-line recoil path, bolt-action rifle. Available in a variety of calibers, the Ruger Precision® Rifle offers outstanding accuracy and long-range capability.



RUGER PRECISION® RIFLE



6.5
CREEDMOOR

6mm
CREEDMOOR

300
WIN
MAG

308
WIN

338
LAPUA
MAG

FIVE CALIBERS

FIVE MODELS

OUTSTANDING ACCURACY AND LONG-RANGE CAPABILITY

NEW Ruger Precision® Rifle
in .300 Win. Mag.
(Model 18081)

RUGER PRECISION® RIFLE

FEATURES

- In-line recoil path manages recoil directly from the rear of the receiver to the buttstock, not through a traditional bedding system, providing maximum accuracy potential.
- Cold hammer-forged, chrome-moly steel barrel with 5R Rifling at minimum bore and groove dimensions, minimum headspace and centralized chamber.
- Ruger Marksman Adjustable™ trigger is externally adjustable, with a trigger pull range of 2.25 to 5 pounds; wrench is stored in the bolt shroud.
- Ruger Precision® MSR stock with QD sling attachment points features a bottom Picatinny rail and soft rubber buttpad. The left-folding stock hinge is attached to an AR-style buffer tube and accepts any AR-style stock. Length of pull and comb height are adjustable.
- Barrel features a Ruger Precision® Rifle Hybrid or Magnum Muzzle Brake to effectively reduce recoil while minimizing noise and blast to the sides of the shooter.
- Aluminum free-float handguard is black hard-coat anodized aluminum and features Magpul® M-LOK® slots on all four sides for improved scope clearance for long-range scopes and easy mounting of M-LOK-compatible rails and accessories.
- Ambidextrous manual safety for left- or right-handed lever manipulation.
- 20 or 30 MOA Picatinny rail secured with #8-40 screws for increased long-range elevation capabilities, depending on caliber.
- “Upper” receiver and one-piece bolt are precision CNC-machined from pre-hardened 4140 chrome-moly steel to minimize distortion.
- Three-lug bolt with 70° throw features dual cocking cams and a smooth-running, full diameter bolt body. Bolt body is nitrided for corrosion resistance, smooth operation and durability.
- Barrel can be replaced easily by a competent gunsmith using headspace gauges.
- Magazine well front is contoured for a positive grip when bracing against shooting supports.
- Oversized bolt handle for positive bolt manipulation, with a 5/16"-24 thread pattern for easy replacement. Bolt disassembly tool is stored in the Ruger Precision® Rifle Billet Aluminum Bolt Shroud for easy striker channel cleaning.
- “Lower” magazine well halves are precision machined from aerospace-grade 7075-T6 aluminum and are Type III hard-coat anodized for maximum durability.
- Extended trigger-reach AR-style grip and 45° ambidextrous safety selector. May be configured with any AR-style grip and selector.
- Also includes: two magazines.



Ruger Precision® Rifle in 6.5 Creedmoor
(Model 18029)

Model Number	COMPARE									
	Caliber	Capacity	Barrel Length	Folded Length	Overall Length	Height	Width	Weight	Twist	Suggested Retail
18028	308 Win	10	20"	31.60"	39.25" - 42.75"	7.30"	3.30"	9.8 lbs.	1:10"	\$1,599.00
18029	6.5 Creedmoor	10	24"	35.60"	43.25" - 46.75"	7.30"	3.30"	10.7 lbs.	1:8"	\$1,599.00
18032	6mm Creedmoor	10	24"	35.60"	43.25" - 46.75"	7.30"	3.30"	10.8 lbs.	1:7.7"	\$1,599.00
NEW 18080	338 Lapua Mag	5	26"	40.35"	49" - 52.50"	7.50"	3.50"	15.2 lbs.	1:9.375"	\$2,099.00
NEW 18081	300 Win Mag	5	26"	40.35"	49" - 52.50"	7.50"	3.50"	15.2 lbs.	1:9"	\$2,099.00



Equipped with a Free-Float Handguard
Featuring Magpul® M-LOK® Slots



Picatinny Rail



Ambidextrous Safety



Ruger Precision® MSR Stock with
QD Sling Attachment Points
Features a Bottom Picatinny Rail
and Soft Rubber Buttpad





RUGER PRECISION® RIMFIRE

Bringing the big-gun experience to the rimfire world, the **Ruger Precision® Rimfire** is a scaled down version of the Ruger Precision® Rifle that maintains the same ergonomics, trigger and manual of arms as the larger centerfire rifle. This rifle is the ideal rimfire trainer and the go-to rifle for your next rimfire match.



RUGER PRECISION® RIMFIRE



22
LR

22
WMR

17
HMR

THREE CALIBERS

SIX MODELS

QUICK-FIT PRECISION RIMFIRE ADJUSTABLE STOCK

NEW Ruger Precision® Rimfire
in .17 HMR
(Model 8402)

RUGER PRECISION® RIMFIRE

FEATURES

- Molded, one-piece chassis and adjustable buttstock assembly are manufactured with glass-filled nylon for strength, stiffness and stability, making a solid foundation for accuracy each and every shot. Adjustable buttstock features a flat Picatinny bag rider making it easy to affix a rear monopod. A molded-in window provides a tether point for your squeeze bag, and a metal QD pocket makes it easy to secure a sling.
- Quick-Fit adjustable Precision Rimfire stock allows length of pull and comb height to be quickly and easily adjusted to get proper fit over a wide range of shooter sizes, outerwear and shooting positions. Indicating marks molded into the chassis help you quickly return to a previous position.
- Big-Gun bolt throw adjustment enables shooters to change from a rimfire 1-1/2" bolt throw to a short-action centerfire 3" bolt throw, reducing the chance of short-stroking your bolt in competition.
- Ruger Marksman Adjustable™ trigger is externally adjustable, with a trigger pull range of 2.25 to 5 pounds; wrench is stored in a buttstock compartment.
- Ruger's own AR-pattern pistol grip and safety selector provides an extended reach for maximum control and access to the 45°, reversible safety selector. May be configured with most AR-style grips and selectors.
- Features anodized Picatinny scope base.
- Oversized bolt handle for positive bolt manipulation (same as the Ruger Precision® Rifle).
- 15" aluminum free-float handguard is black hard-coat anodized aluminum and features Magpul® M-LOK® slots on all four sides for improved scope clearance for long-range scopes and easy mounting of M-LOK-compatible rails and accessories.
- 18" target barrel is cold hammer-forged from 1137 alloy steel to create ultra precise rifling for excellent accuracy. Barrel can be replaced easily by a competent gunsmith using AR-style wrenches and headspace gauges.
- 1/2"-28 threaded barrel for standard muzzle accessories, like the Silent-SR® suppressor, comes with a factory-installed thread protector covering both the threads and crown.



NEW

Ruger Precision® Rimfire in .17 HMR
(Model 8402*)

Model Number	Caliber	Capacity	Stock	Magazine	Barrel Length	Overall Length	Height	Width	Weight	Length of Pull	Thread Pattern	Twist	Suggested Retail
8400*	22 LR	15	Quick-Fit Precision Rimfire Adjustable	One BX-15®	18"	35.13" - 38.63"	6.88"	3.38"	6.8 lbs.	12" - 15.50"	1/2"-28	1:16"	\$529.00
8401	22 LR	10	Quick-Fit Precision Rimfire Adjustable	Two BX-1	18"	35.13" - 38.63"	6.88"	3.38"	6.8 lbs.	12" - 15.50"	1/2"-28	1:16"	\$529.00
NEW 8402*	17 HMR	15	Quick-Fit Precision Rimfire Adjustable	One BX-15® Magnum	18"	35.13" - 38.63"	6.88"	3.38"	6.8 lbs.	12" - 15.50"	1/2"-28	1:9"	\$529.00
NEW 8403	17 HMR	9	Quick-Fit Precision Rimfire Adjustable	One JMX-1	18"	35.13" - 38.63"	6.88"	3.38"	6.8 lbs.	12" - 15.50"	1/2"-28	1:9"	\$529.00
NEW 8404*	22 WMR	15	Quick-Fit Precision Rimfire Adjustable	One BX-15® Magnum	18"	35.13" - 38.63"	6.88"	3.38"	6.8 lbs.	12" - 15.50"	1/2"-28	1:14"	\$529.00
NEW 8405	22 WMR	9	Quick-Fit Precision Rimfire Adjustable	One JMX-1	18"	35.13" - 38.63"	6.88"	3.38"	6.8 lbs.	12" - 15.50"	1/2"-28	1:14"	\$529.00



Ruger Marksman Adjustable™ Trigger with 2.25 to 5.0 lb. Pull Weight



Quick-Fit Adjustable Precision Rimfire Stock



Adjustable Big-Gun Bolt Throw



15" Free-Float Hard Black Anodized Aluminum Handguard



1/2"-28 Threaded Barrel for Standard Muzzle Accessories Including the Silent-SR®



* Some rifles may not be available in all states and locales due to laws limiting magazine capacity. Please check with your local law enforcement agency prior to purchasing this firearm to verify that it may legally be purchased and/or possessed in your particular state and locale.



RUGER AMERICAN® RIFLE

Another engineering innovation from America's leading firearms manufacturer, the **Ruger American® Rifle** combines Ruger's famous rugged reliability with the award-winning ingenuity featured in so many of Ruger's new products.



RUGER AMERICAN® RIFLE



- 204 RUGER
- 223 REM
- 5.56 NATO/223 REM
- 6.5 GRENDL
- 300 BLK
- 450 BUSH-MASTER
- 22-250 REM
- 243 WIN
- 6mm CREEDMOOR
- 6.5 CREEDMOOR
- 7mm-08 REM
- 762 X39
- 308 WIN
- 270 WIN
- 30-06 SPRG
- 300 WIN MAG

- STANDARD
- COMPACT
- PREDATOR
- RANCH
- MAGNUM

Ruger American® Rifle Predator in 6.5 Creedmoor (Model 26973)

Ruger American® Rifle Ranch in .450 Bushmaster (Model 16950)

FEATURES

- Ruger Marksman Adjustable™ trigger offers a crisp release with a pull weight that is user adjustable between 3 and 5 pounds, allowing shooters to make that perfect shot.
- Ergonomic, lightweight synthetic stock designed for quick, easy handling blends a classic look with modern forend contouring and grip serrations.
- Soft rubber buttpad is crafted for maximum recoil reduction.
- The one-piece, three-lug bolt with 70° throw provides ample scope clearance and utilizes a full diameter bolt body and dual cocking cams for smooth, easy cycling from the shoulder.
- Patented Power Bedding®, integral bedding block system positively locates the receiver and free-floats the barrel for outstanding accuracy.
- Factory-installed, one-piece Picatinny scope base.
- Offers minute-of-angle accuracy that can make every hunt a success.
- Cold hammer-forged barrel results in ultra-precise rifling that provides exceptional accuracy and longevity.
- The visible, accessible and easy-to-actuate tang safety provides instant security.
- Also includes: one magazine; sling swivel studs.



Patented Power Bedding® Integral Bedding Blocks for Outstanding Accuracy



Ruger Marksman Adjustable™ Trigger Provides a Crisp Release with a User-Adjustable 3-5 lb. Trigger Pull



Visible, Accessible and Easy-to-Actuate Tang Safety



Cold Hammer-Forged Barrel



Ergonomic, Lightweight Stock



One-Piece, Three-Lug Bolt with 70° Throw Provides Ample Scope Clearance



RUGER AMERICAN® RIFLE

RUGER AMERICAN® RIFLE



Model 6901 Shown

Model Number	COMPARE											
	Caliber	Capacity	Magazine	Material/Finish	Stock	Sights	Barrel Length	Overall Length	Weight	Length of Pull	Twist	Suggested Retail
6904	243 Win	4	Flush-Fit	Alloy Steel/Matte Black	Black Synthetic	None	22"	42"	6.2 lbs.	13.75"	1:9"	\$489.00
6902	270 Win	4	Flush-Fit	Alloy Steel/Matte Black	Black Synthetic	None	22"	42.50"	6.2 lbs.	13.75"	1:10"	\$489.00
6906	7mm-08 Rem	4	Flush-Fit	Alloy Steel/Matte Black	Black Synthetic	None	22"	42"	6.3 lbs.	13.75"	1:9.5"	\$489.00
6901	30-06 Sprg	4	Flush-Fit	Alloy Steel/Matte Black	Black Synthetic	None	22"	42.50"	6.2 lbs.	13.75"	1:10"	\$489.00
6903	308 Win	4	Flush-Fit	Alloy Steel/Matte Black	Black Synthetic	None	22"	42"	6.1 lbs.	13.75"	1:10"	\$489.00

RUGER AMERICAN® RIFLE COMPACT



Model 6908 Shown

Compact models feature a shorter length of pull (for smaller shooters or those wearing heavier outerwear) and a shorter barrel, for a reduction in overall length of more than five inches.

Model Number	COMPARE											
	Caliber	Capacity	Magazine	Material/Finish	Stock	Sights	Barrel Length	Overall Length	Weight	Length of Pull	Twist	Suggested Retail
6908	243 Win	4	Flush-Fit	Alloy Steel/Matte Black	Black Synthetic	None	18"	36.75"	6 lbs.	12.50"	1:9"	\$489.00
6909	7mm-08 Rem	4	Flush-Fit	Alloy Steel/Matte Black	Black Synthetic	None	18"	36.75"	6 lbs.	12.50"	1:9.5"	\$489.00
6907	308 Win	4	Flush-Fit	Alloy Steel/Matte Black	Black Synthetic	None	18"	36.75"	6 lbs.	12.50"	1:10"	\$489.00

RUGER AMERICAN® RIFLE MAGNUM



Threaded Barrel with Factory-Installed Thread Protector

Model Number	Caliber	Capacity	Magazine	Material/Finish	Stock	Sights	Barrel Length	Overall Length	Thread Pattern	Weight	Length of Pull	Twist	Suggested Retail
16912	300 Win Mag	3	Single-Stack	Stainless Steel/Matte Stainless	Black Synthetic	None	24"	44.50"	5/8"-24	7.5 lbs.	13.75"	1:10"	\$699.00

RUGER AMERICAN® RIFLE with Vortex® Crossfire II® Riflescope



Model 16933 Shown

SCOPE SPECIFICATIONS

Reticle: Dead-Hold BDC

Item Number: CF2-31007

Construction Features: Waterproof, Fogproof, Shockproof

Adjustment Markings: 1/4 MOA Finger Click Adjustments

Maintube Diameter: 1"

Material: Aircraft Grade Aluminum

Magnification: 3-9x

Linear Field of View (ft @ 100yd): 34.1 - 12.6

Objective Lens Diameter: 40mm

Model Number	COMPARE											
	Caliber	Capacity	Magazine	Material/Finish	Stock	Sights	Barrel Length	Overall Length	Weight	Length of Pull	Twist	Suggested Retail
16931	243 Win	4	Flush-Fit	Alloy Steel/Matte Black	Black Synthetic	Vortex® Crossfire II® Riflescope	22"	42"	7.2 lbs.	13.75"	1:9"	\$639.00
16932	270 Win	4	Flush-Fit	Alloy Steel/Matte Black	Black Synthetic	Vortex® Crossfire II® Riflescope	22"	42.50"	7.1 lbs.	13.75"	1:10"	\$639.00
16933	30-06 Sprg	4	Flush-Fit	Alloy Steel/Matte Black	Black Synthetic	Vortex® Crossfire II® Riflescope	22"	42.50"	7.1 lbs.	13.75"	1:10"	\$639.00
16934	308 Win	4	Flush-Fit	Alloy Steel/Matte Black	Black Synthetic	Vortex® Crossfire II® Riflescope	22"	42"	7 lbs.	13.75"	1:10"	\$639.00
16937	223 Rem	5	Flush-Fit	Alloy Steel/Matte Black	Black Synthetic	Vortex® Crossfire II® Riflescope	22"	42"	7.2 lbs.	13.75"	1:8"	\$639.00

RUGER AMERICAN® RIFLE RANCH



Model 16976 Shown

Threaded Barrel with Factory-Installed Thread Protector or Ruger® Hybrid Muzzle Brake (Model 16950)

Model Number	COMPARE												
	Caliber	Capacity	Magazine	Material/Finish	Stock	Sights	Barrel Length	Overall Length	Thread Pattern	Weight	Length of Pull	Twist	Suggested Retail
26965	5.56 NATO/223 Rem	10	AR-Style	Alloy Steel/Matte Black	Flat Dark Earth Synthetic	None	16.12"	36"	1/2"-28	6.1 lbs.	13.75"	1:8"	\$599.00
6965	5.56 NATO/223 Rem	5	Flush-Fit	Alloy Steel/Matte Black	Flat Dark Earth Synthetic	None	16.12"	36"	1/2"-28	6.1 lbs.	13.75"	1:8"	\$529.00
26968	300 BLK	10	AR-Style	Alloy Steel/Matte Black	Flat Dark Earth Synthetic	None	16.12"	36"	5/8"-24	5.9 lbs.	13.75"	1:7"	\$599.00
6968	300 BLK	5	Flush-Fit	Alloy Steel/Matte Black	Flat Dark Earth Synthetic	None	16.12"	36"	5/8"-24	5.9 lbs.	13.75"	1:7"	\$529.00
16950	450 Bushmaster	3	Single-Stack	Alloy Steel/Matte Black	Flat Dark Earth Synthetic	None	16.12"	36"	11/16"-24	5.6 lbs.	13.75"	1:16"	\$599.00
16976	7.62x39	5	Mini Thirty®	Alloy Steel/Matte Black	Flat Dark Earth Synthetic	None	16.12"	36"	5/8"-24	5.9 lbs.	13.75"	1:9.5"	\$599.00

RUGER AMERICAN® RIFLE

RUGER AMERICAN® RIFLE PREDATOR



Model 26973 Shown

Threaded Barrel with
Factory-Installed Thread Protector

Model Number	Caliber	Capacity	Magazine	Material/Finish	Stock	Sights	Barrel Length	Overall Length	Thread Pattern	Weight	Length of Pull	Twist	Suggested Retail
26971	204 Ruger	10	AI-Style	Alloy Steel/ Matte Black	Moss Green Synthetic	None	22"	42"	1/2"-28	6.6 lbs.	13.75"	1:12"	\$599.00
6945	22-250 Rem	4	Flush-Fit	Alloy Steel/ Matte Black	Moss Green Synthetic	None	22"	42"	1/2"-28	6.6 lbs.	13.75"	1:10"	\$529.00
26944	223 Rem	10	AR-Style	Alloy Steel/ Matte Black	Moss Green Synthetic	None	22"	42"	1/2"-28	6.6 lbs.	13.75"	1:8"	\$599.00
26972	243 Win	3	AI-Style	Alloy Steel/ Matte Black	Moss Green Synthetic	None	22"	42"	5/8"-24	6.6 lbs.	13.75"	1:9"	\$599.00
26973	6.5 Creedmoor	3	AI-Style	Alloy Steel/ Matte Black	Moss Green Synthetic	None	22"	42"	5/8"-24	6.6 lbs.	13.75"	1:8"	\$599.00
6973	6.5 Creedmoor	4	Flush-Fit	Alloy Steel/ Matte Black	Moss Green Synthetic	None	22"	42"	5/8"-24	6.6 lbs.	13.75"	1:8"	\$529.00
16977 LH	6.5 Creedmoor	4	Flush-Fit	Alloy Steel/ Matte Black	Moss Green Synthetic	None	22"	42"	5/8"-24	6.6 lbs.	13.75"	1:8"	\$569.00
NEW LH 26916	243 Win	4	Flush-Fit	Alloy Steel/ Matte Black	Moss Green Synthetic	None	22"	42"	5/8"-24	6.6 lbs.	13.75"	1:9"	\$569.00
NEW LH 26917	7mm-08 Rem	4	Flush-Fit	Alloy Steel/ Matte Black	Moss Green Synthetic	None	22"	42"	5/8"-24	6.6 lbs.	13.75"	1:8.5"	\$569.00
NEW LH 26918	308 Win	4	Flush-Fit	Alloy Steel/ Matte Black	Moss Green Synthetic	None	22"	42"	5/8"-24	6.6 lbs.	13.75"	1:10"	\$569.00
26948	6mm Creedmoor	3	AI-Style	Alloy Steel/ Matte Black	Moss Green Synthetic	None	22"	42"	5/8"-24	6.6 lbs.	13.75"	1:7.7"	\$599.00
26974	308 Win	3	AI-Style	Alloy Steel/ Matte Black	Moss Green Synthetic	None	18"	38"	5/8"-24	6.2 lbs.	13.75"	1:10"	\$599.00
6974	308 Win	4	Flush-Fit	Alloy Steel/ Matte Black	Moss Green Synthetic	None	18"	38"	5/8"-24	6.2 lbs.	13.75"	1:10"	\$529.00
26922	6.5 Grendel	10	Aluminum AR-Style	Alloy Steel/ Matte Black	Moss Green Synthetic	None	22"	42"	5/8"-24	6.6 lbs.	13.75"	1:8"	\$599.00

RUGER AMERICAN® RIFLE PREDATOR with Vortex® Crossfire II® Riflescope



Model 26952 Shown

SCOPE SPECIFICATIONS

Reticle: Dead-Hold BDC

Construction Features: Waterproof,
Fogproof, Shockproof

Adjustment Markings: 1/4 MOA
Finger Click Adjustments

Maintube Diameter: 1"

Material: Aircraft-Grade Aluminum

Magnification: 4-12x

Linear Field of View (ft @ 100yd): 24.7 - 8.4

Objective Lens Diameter: 44 mm

Model Number	Caliber	Capacity	Magazine	Material/Finish	Stock	Sights	Barrel Length	Overall Length	Thread Pattern	Weight	Length of Pull	Twist	Suggested Retail
26951	223 Rem	10	AR-Style	Alloy Steel/ Matte Black	Moss Green Synthetic	Vortex® Crossfire II® Riflescope	22"	42"	1/2"-28	7.6 lbs.	13.75"	1:8"	\$799.00
26952	204 Ruger	10	AI-Style	Alloy Steel/ Matte Black	Moss Green Synthetic	Vortex® Crossfire II® Riflescope	22"	42"	1/2"-28	7.6 lbs.	13.75"	1:12"	\$799.00
26953	6.5 Creedmoor	3	AI-Style	Alloy Steel/ Matte Black	Moss Green Synthetic	Vortex® Crossfire II® Riflescope	22"	42"	5/8"-24	7.6 lbs.	13.75"	1:8"	\$799.00
16953	6.5 Creedmoor	4	Flush-Fit	Alloy Steel/ Matte Black	Moss Green Synthetic	Vortex® Crossfire II® Riflescope	22"	42"	5/8"-24	7.6 lbs.	13.75"	1:8"	\$699.00
26954	308 Win	3	AI-Style	Alloy Steel/ Matte Black	Moss Green Synthetic	Vortex® Crossfire II® Riflescope	18"	38"	5/8"-24	7.2 lbs.	13.75"	1:10"	\$799.00

RUGER AMERICAN® RIFLE with GO Wild® Camo I-M Brush® Stock



Model 26925 Shown

GO Wild® Camo I-M Brush® Stock

Model Number	Caliber	Capacity	Magazine	Finish	Stock	Sights	Barrel Length	Overall Length	Thread Pattern	Weight	Length of Pull	Twist	Suggested Retail
26923	7mm-08 Rem	3	AI-Style	Cerakote Bronze	GO Wild® Camo I-M Brush®	None	22"	42"	5/8"-24	6.6 lbs.	13.75"	1:8.5"	\$629.00
26924	243 Win	3	AI-Style	Cerakote Bronze	GO Wild® Camo I-M Brush®	None	22"	42"	5/8"-24	6.6 lbs.	13.75"	1:9"	\$629.00
26925	6.5 Creedmoor	3	AI-Style	Cerakote Bronze	GO Wild® Camo I-M Brush®	None	22"	42"	5/8"-24	6.6 lbs.	13.75"	1:8"	\$629.00
26926	308 Win	3	AI-Style	Cerakote Bronze	GO Wild® Camo I-M Brush®	None	22"	42"	5/8"-24	6.6 lbs.	13.75"	1:10"	\$629.00
26927	30-06 Sprg	4	Flush-Fit	Cerakote Bronze	GO Wild® Camo I-M Brush®	None	22"	42"	5/8"-24	6.6 lbs.	13.75"	1:10"	\$629.00
26928	450 Bushmaster	3	Single- Stack	Cerakote Bronze	GO Wild® Camo I-M Brush®	None	22"	42"	11/6"-24	6.6 lbs.	13.75"	1:16"	\$629.00
26929	300 Win Mag	3	Single- Stack	Cerakote Bronze	GO Wild® Camo I-M Brush®	None	24"	44"	5/8"-24	7.1 lbs.	13.75"	1:10"	\$629.00

LH: Left-Handed.



RUGER AMERICAN® RIMFIRE

The **Ruger American® Rimfire** bolt-action rifle builds on the enormous success of the centerfire Ruger American® Rifle. With many of the standard Ruger American® Rifle features, this line also combines several design innovations from the popular 10/22® rimfire rifle. This combination, along with the rifle's adaptability, will appeal to all bolt-action rifle enthusiasts – young or old, novice or experienced.



RUGER AMERICAN® RIMFIRE



22 LR

22 WMR

17 HMR

THREE CALIBERS

EIGHTEEN MODELS

STANDARD

COMPACT

TARGET

WOOD STOCK

Ruger American® Rimfire Target in .17 HMR (Model 8350)

Ruger American® Rimfire Stainless in .22 LR (Model 8351)

RUGER AMERICAN® RIMFIRE

FEATURES

- Models configured with a synthetic stock include two interchangeable stock modules that provide comb height options for scope or iron sight use. By simply removing the rear sling swivel stud, stock modules can be changed in seconds. All four stock modules are completely interchangeable across all models and are available at ShopRuger.com.
- Models chambered in .22 LR include the patented, detachable, flush-mounted BX-1, 10-round rotary magazine and accept all 10/22® magazines, including the BX-25®, BX-25®x2 and BX-15®.
- Models chambered in .22 Magnum and .17 HMR use the detachable, flush-mounted JMX-1, 9-round rotary magazine and accept the BX-15® Magnum magazine.
- Easy-to-use, extended magazine release provides smooth, no-fuss removal of the flush-mounted magazine.
- Patented Power Bedding® integral bedding block system positively locates the receiver and free-floats the barrel for outstanding accuracy.
- Ruger Marksman Adjustable™ trigger offers a crisp release with a pull weight that is user adjustable between three and five pounds, allowing shooters to make that perfect shot.
- Features a visible, accessible and easy-to-actuate tang safety that provides instant security.
- Cold hammer-forged barrel results in ultra-precise rifling that provides exceptional accuracy and longevity.
- A 3/8" rimfire scope base is machined into the receiver, which is also drilled and tapped for Weaver™ #12 bases.
- A 60° bolt provides ample scope clearance and the easy-to-use, receiver-mounted bolt release allows the bolt to be readily removed without requiring a pull of the trigger, a unique safety feature among rimfire, bolt-action rifles.
- Williams™ fiber optic front sight and adjustable, "V" slot, folding-leaf rear sight (excludes Stainless and Target models).
- Also includes: sling swivel studs.



Visible, Accessible and Easy-to-Actuate Tang Safety



Ruger Marksman Adjustable™ Trigger Provides a Crisp Release with a User-Adjustable 3-5 lb. Trigger Pull



Detachable Rotary Magazine Provides Reliable Feeding

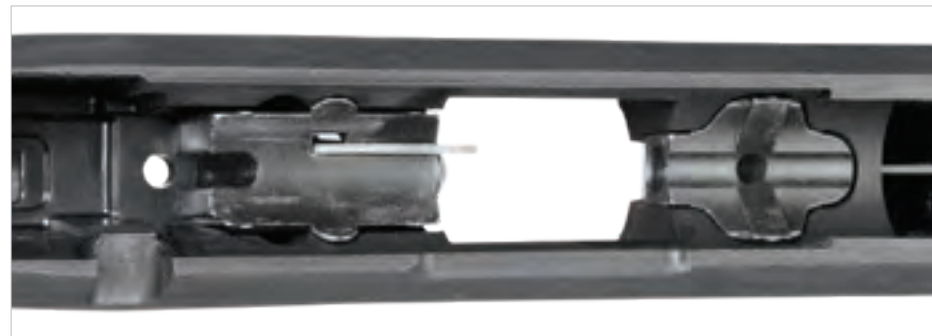

Patented Power Bedding® Integral Bedding Block for Outstanding Accuracy



Williams™ Fiber Optic Front Sight and Adjustable, "V" Slot, Folding-Leaf Rear Sight (Excludes Stainless and Target Models)



RUGER AMERICAN® RIMFIRE

RUGER AMERICAN® RIMFIRE



Model Number	COMPARE			Material/ Finish	Stock	Sights	Barrel Length	Overall Length	Thread Pattern	Weight	Length of Pull	Twist	Suggested Retail
	Caliber	Capacity											
8311	17 HMR	9		Alloy Steel/Satin Blued	Black Synthetic	Williams™ Fiber Optic Front, Adjustable Rear	22"	41"	–	6 lbs.	13.75"	1:9"	\$359.00
8301	22 LR	10		Alloy Steel/Satin Blued	Black Synthetic	Williams™ Fiber Optic Front, Adjustable Rear	22"	41"	–	6 lbs.	13.75"	1:16"	\$359.00
8321	22 WMR	9		Alloy Steel/Satin Blued	Black Synthetic	Williams™ Fiber Optic Front, Adjustable Rear	22"	41"	–	6 lbs.	13.75"	1:14"	\$359.00
8312	17 HMR	9		Alloy Steel/Satin Blued	Black Synthetic	Williams™ Fiber Optic Front, Adjustable Rear	18"	37"	1/2"-28	5.5 lbs.	13.75"	1:9"	\$389.00
8305	22 LR	10		Alloy Steel/Satin Blued	Black Synthetic	Williams™ Fiber Optic Front, Adjustable Rear	18"	37"	1/2"-28	5.5 lbs.	13.75"	1:16"	\$389.00
8322	22 WMR	9		Alloy Steel/Satin Blued	Black Synthetic	Williams™ Fiber Optic Front, Adjustable Rear	18"	37"	1/2"-28	5.5 lbs.	13.75"	1:14"	\$389.00

RUGER AMERICAN® RIMFIRE Compact



Model Number	COMPARE			Material/ Finish	Stock	Sights	Barrel Length	Overall Length	Thread Pattern	Weight	Length of Pull	Twist	Suggested Retail
	Caliber	Capacity											
8313	17 HMR	9		Alloy Steel/Satin Blued	Black Synthetic	Williams™ Fiber Optic Front, Adjustable Rear	18"	35.75"	–	5.3 lbs.	12.50"	1:9"	\$359.00
8303	22 LR	10		Alloy Steel/Satin Blued	Black Synthetic	Williams™ Fiber Optic Front, Adjustable Rear	18"	35.75"	–	5.3 lbs.	12.50"	1:16"	\$359.00
8323	22 WMR	9		Alloy Steel/Satin Blued	Black Synthetic	Williams™ Fiber Optic Front, Adjustable Rear	18"	35.75"	–	5.3 lbs.	12.50"	1:14"	\$359.00
8306	22 LR	10		Alloy Steel/Satin Blued	Black Synthetic	Williams™ Fiber Optic Front, Adjustable Rear	18"	35.75"	1/2"-28	5.3 lbs.	12.50"	1:16"	\$389.00

RUGER AMERICAN® RIMFIRE with Wood Stock



Model Number	Caliber	Capacity	Material/ Finish	Stock	Sights	Barrel Length	Overall Length	Weight	Length of Pull	Twist	Suggested Retail
8329	22 LR	10	Alloy Steel/Satin Blued	Wood	Williams™ Fiber Optic Front, Adjustable Rear	22"	41"	6.1 lbs.	13.75"	1:16"	\$459.00

RUGER AMERICAN® RIMFIRE STAINLESS



Model Number	COMPARE			Material/ Finish	Stock	Sights	Barrel Length	Overall Length	Thread Pattern	Weight	Length of Pull	Twist	Suggested Retail
	Caliber	Capacity											
8351	22 LR	10		Stainless Steel/Satin Stainless	Black Synthetic	None	18"	37"	1/2"-28	5.3 lbs.	13.75"	1:16"	\$429.00
8352	22 WMR	9		Stainless Steel/Satin Stainless	Black Synthetic	None	18"	37"	1/2"-28	5.3 lbs.	13.75"	1:14"	\$429.00
8353	17 HMR	9		Stainless Steel/Satin Stainless	Black Synthetic	None	18"	37"	1/2"-28	5.3 lbs.	13.75"	1:9"	\$429.00

RUGER AMERICAN® RIMFIRE TARGET



Model Number	COMPARE			Material/ Finish	Stock	Sights	Barrel Length	Overall Length	Thread Pattern	Weight	Length of Pull	Twist	Suggested Retail
	Caliber	Capacity											
8350	17 HMR	9		Alloy Steel/Satin Blued	Black Laminate	None	18"	37"	1/2"-28	6.8 lbs.	13.75"	1:9"	\$499.00
8348	22 LR	10		Alloy Steel/Satin Blued	Black Laminate	None	18"	37"	1/2"-28	6.7 lbs.	13.75"	1:16"	\$499.00
8349	22 WMR	9		Alloy Steel/Satin Blued	Black Laminate	None	18"	37"	1/2"-28	6.7 lbs.	13.75"	1:14"	\$499.00

RUGER AMERICAN® RIMFIRE TARGET with Thumbhole Stock



Model Number	Caliber	Capacity	Material/ Finish	Stock	Sights	Barrel Length	Overall Length	Thread Pattern	Weight	Length of Pull	Twist	Suggested Retail
8360	22 LR	10	Alloy Steel/Satin Blued	Black Laminate with Thumbhole	None	18"	37"	1/2"-28	6.7 lbs.	13.75"	1:16"	\$559.00



RUGER® SCOUT RIFLE

The one rifle to have if you could have only one. The **Ruger® Scout Rifle** is the perfect lightweight, hard-hitting, do-it-all bolt-action rifle.



Ruger® Scout Rifle
in .450 Bushmaster
(Model 6837)

Ruger® Scout Rifle
with Synthetic Stock
(Model 6830)

RUGER® SCOUT RIFLE



308
WIN

450
BUSH-
MASTER

TWO CALIBERS

SEVEN MODELS

BLACK
LAMINATE

BLACK
SYNTHETIC

AMERICAN
WALNUT

RUGER® SCOUT RIFLE

FEATURES

- Forward-mounted Picatinny rail allows for the mounting of modern optics, like an intermediate eye relief scope (not included), for “both eyes open” sighting and rapid target acquisition.
- Built-in, accurate sighting system with adjustable ghost ring rear aperture sight and a non-glare, protected blade front sight.
- Detachable box magazine with push-forward magazine release just forward of the trigger guard.
- Integral scope mounts, machined directly on the solid-steel receiver, provide a stable mounting surface for included scope rings, eliminating a potential source of looseness and inaccuracy in the field.
- Soft-rubber buttpad with buttpad spacers allows the rifle to be properly sized for different shooters or varying levels of outerwear (three, 1/2" spacers included).
- Free-floating, cold hammer-forged barrel results in ultra-precise rifling that provides exceptional accuracy and longevity.
- Rugged and reliable glass-reinforced nylon trigger guard and magazine well.
- Non-rotating, Mauser-type controlled round feed extractor is among the most positive case extraction systems ever invented, and features a fixed blade-type ejector that positively ejects the empty cases as the bolt is moved fully rearward.
- Laminate stock models feature durable, laminated wood that free floats the barrel and remains stable in weather and temperature extremes.
- Lightweight synthetic stock models feature a forward aluminum bedding block and rear aluminum pillar that positively locate the receiver.
- Models 6837 and 6838 feature a Ruger® Hybrid Muzzle Brake (thread protector included).
- Three-position safety is easily accessible and allows the shooter to lock the bolt or to load and unload the rifle with the safety engaged.
- Rugged, one-piece, stainless steel bolt.
- Also includes: sling swivel studs.



NEW

Ruger® Scout Rifle in .450 Bushmaster
(Model 6838)

COMPARE												
Model Number	Caliber	Capacity	Material/Finish	Stock	Barrel Feature	Barrel Length	Overall Length	Weight*	Length of Pull	Twist	Thread Pattern	Suggested Retail
6803	308 Win	10	Alloy Steel/Matte Black	Black Laminate	Flash Suppressor	16.10"	37"- 38.50"	7.1 lbs.	12.75"- 14.25"	1:10"	5/8"-24	\$1,139.00
6821 LH	308 Win	10	Stainless Steel/Matte Stainless	Black Laminate	Flash Suppressor	18.70"	39.50"- 41"	7.3 lbs.	12.75"- 14.25"	1:10"	5/8"-24	\$1,199.00
6822	308 Win	10	Stainless Steel/Matte Stainless	Black Laminate	Flash Suppressor	18.70"	39.50"- 41"	7.3 lbs.	12.75"- 14.25"	1:10"	5/8"-24	\$1,199.00
6829	308 Win	10	Stainless Steel/Matte Stainless	Black Synthetic	Muzzle Brake	16.10"	37"- 38.50"	6.2 lbs.	12.75"- 14.25"	1:10"	5/8"-24	\$1,199.00
6830	308 Win	10	Alloy Steel/Matte Black	Black Synthetic	Muzzle Brake	16.10"	37"- 38.50"	6.2 lbs.	12.75"- 14.25"	1:10"	5/8"-24	\$1,139.00
6837	450 Bushmaster	4	Alloy Steel/Matte Black	American Walnut	Ruger® Hybrid Muzzle Brake	16.10"	37"- 38.50"	6.6 lbs.	12.75"- 14.25"	1:16"	11/16"-24	\$1,199.00
NEW 6838	450 Bushmaster	4	Stainless Steel/Matte Stainless	Black Synthetic	Ruger® Hybrid Muzzle Brake	16.10"	37"- 38.50"	6.2 lbs.	12.75"- 14.25"	1:16"	11/16"-24	\$1,199.00



Glass-Reinforced Nylon Trigger Guard and Magazine Well



Adjustable Ghost Ring Rear Sight



Buttpad Spacers Allow for Adjustable Length of Pull



Forward-Mounted Picatinny Rail



*Without magazine. **LH:** Left-Handed.



RUGER® GUIDE GUN

Rugged and hard-hitting, the compact and easy-to-carry **Ruger® Guide Gun** is ready for whatever conditions or game come your way.

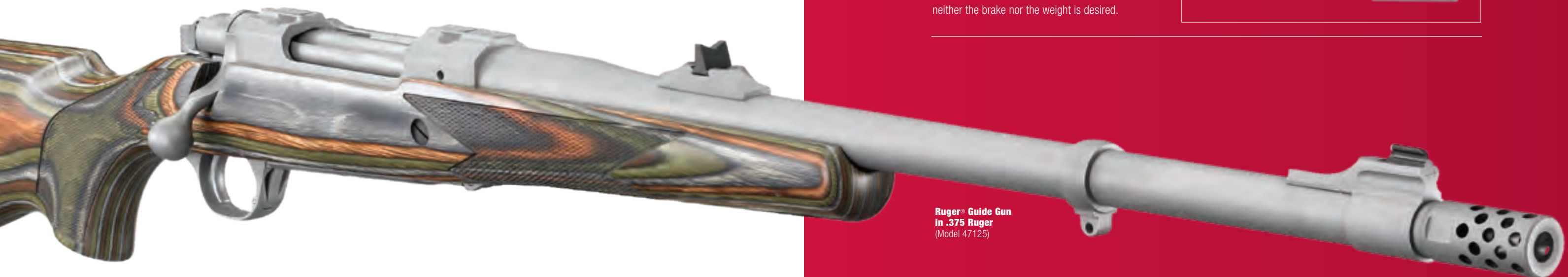

RUGER® GUIDE GUN



300
WIN
MAG

338
WIN
MAG

30-06
SPRG

375
RUGER

416
RUGER

FIVE CALIBERS

SIX MODELS

THE RUGER® MUZZLE BRAKE SYSTEM

Includes a removable, radial-port muzzle brake that significantly reduces felt recoil. For times when the brake is not preferred, it may be replaced with the included dynamically-matched muzzle weight. Switching between the brake and the weight will not change the bullet's point of impact for a particular load. The included thread protector may be used if neither the brake nor the weight is desired.

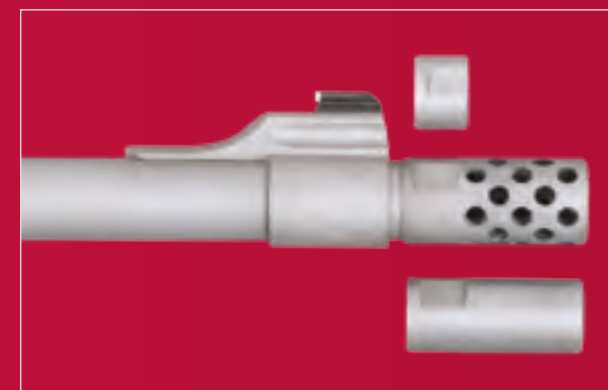

Ruger® Guide Gun
in .375 Ruger
(Model 47125)

RUGER® GUIDE GUN

FEATURES

- Shallow “express-style” windage-adjustable V-notch rear sight and large white bead front sight for instant target acquisition.
- Rugged, Green Mountain laminate stock is dimensionally stable in environmental extremes, and features a soft rubber buttpad with buttpad spacers that allow the rifle to be properly sized for different shooters or varying levels of outerwear (three, 1/2" spacers included). Wrap-around checkering provides a sure grip in any weather.
- The Ruger® Muzzle Brake System includes a removable, radial-port muzzle brake that significantly reduces felt recoil. For times when the brake is not preferred, it may be replaced with the included dynamically-matched muzzle weight. Switching between the brake and the weight will not change the bullet's point of impact for a particular load. The included thread protector may be used if neither the brake nor the weight is desired.
- Non-rotating, Mauser-type controlled round feed extractor is among the most positive case extraction systems ever invented, and features a fixed blade-type ejector that positively ejects the empty cases as the bolt is moved fully rearward.
- The LC6™ trigger features smooth, crisp performance right out of the box for increased accuracy on the range or in the field.
- Hinged solid-steel floorplate for easy unloading without having to chamber each cartridge. Features an engraved Ruger logo and latch that is flush with the trigger guard to avoid accidental dumping of cartridges.
- Three-position safety is easily accessible and allows the shooter to lock the bolt or to load and unload the rifle with the safety engaged.
- Cold hammer-forged barrel results in ultra-precise rifling that provides exceptional accuracy and longevity.
- Integral scope mounts, machined directly on the solid-steel receiver, provide a stable mounting surface for included scope rings, eliminating a potential source of looseness and inaccuracy in the field.
- Rugged, one-piece, stainless steel bolt.
- Also includes: barrel band mounted swivel stud; optional forend swivel stud.



Ruger® Guide Gun in .375 Ruger
(Model 47125)



Model Number	COMPARE		Material/Finish	Stock	Sights	Barrel Length	Overall Length	Weight	Length of Pull	Twist	Suggested Retail
	Caliber	Capacity									
47116	300 Win Mag	3	Stainless Steel/Hawkeye Matte	Green Mountain Laminate	Bead Front, Adjustable Rear	20"	41"- 42.50"	8.1 lbs.	12.75"-14.25"	1:10"	\$1,279.00
47117	338 Win Mag	3	Stainless Steel/Hawkeye Matte	Green Mountain Laminate	Bead Front, Adjustable Rear	20"	41"- 42.50"	8 lbs.	12.75"-14.25"	1:10"	\$1,279.00
47118	30-06 Sprg	4	Stainless Steel/Hawkeye Matte	Green Mountain Laminate	Bead Front, Adjustable Rear	20"	41"- 42.50"	8.1 lbs.	12.75"-14.25"	1:10"	\$1,279.00
47124 LH	375 Ruger	3	Stainless Steel/Hawkeye Matte	Green Mountain Laminate	Bead Front, Adjustable Rear	20"	41"- 42.50"	8.1 lbs.	12.75"-14.25"	1:12"	\$1,279.00
47125	375 Ruger	3	Stainless Steel/Hawkeye Matte	Green Mountain Laminate	Bead Front, Adjustable Rear	20"	41"- 42.50"	8.1 lbs.	12.75"-14.25"	1:12"	\$1,279.00
47130	416 Ruger	3	Stainless Steel/Hawkeye Matte	Green Mountain Laminate	Bead Front, Adjustable Rear	20"	41"- 42.50"	8.1 lbs.	12.75"-14.25"	1:14"	\$1,279.00



Ruger Logo Engraving



“Express-Style” Windage-Adjustable Rear Sight and Large White Bead Front Sight



Integral Scope Mounts



Buttpad Spacers Allow for Adjustable Length of Pull







HAWKEYE®

The classic **Hawkeye®** bolt-action rifles are built with versatility, style and performance in mind, meeting the challenges of hunters throughout the world.



HAWKEYE®

204
RUGER

22-250
REM

223
REM

243
WIN

270
WIN

30-06
SPRG

308
WIN

375
RUGER

300
WIN
MAG

338
WIN
MAG

416
RUGER

6.5
CREEDMOOR

6.5
PRC

7mm
REM
MAG

7mm-08
REM

AFRICAN

STANDARD

**LAMINATE
COMPACT**

**VARMINT
TARGET**

**LONG-
RANGE
TARGET**

PREDATOR

**FTW
HUNTER**

NEW Hawkeye® Long-Range Target in 6.5 Creedmoor (Model 47184)

Hawkeye® FTW Hunter in 6.5 Creedmoor (Model 47170)

FEATURES

- The LC6™ trigger features smooth, crisp performance right out of the box for increased accuracy on the range or in the field.
- Non-rotating, Mauser-type controlled round feed extractor is among the most positive case extraction systems ever invented, and features a fixed blade-type ejector that positively ejects empty cases as the bolt is moved fully rearward.
- The Ruger® Muzzle Brake System includes a removable, radial-port muzzle brake that significantly reduces felt recoil. For times when the brake is not preferred, it may be replaced by the included dynamically-matched muzzle weight. Switching between the brake and the weight will not change the bullet's point of impact for a particular load. The included thread protector may be used if neither the brake nor the weight is desired.
- Hinged, solid-steel floorplate for easy unloading without having to chamber each cartridge. Features an engraved Ruger logo and patented latch that is flush with the trigger guard to avoid accidental dumping of cartridges.
- Three-position safety is easily accessible and allows the shooter to lock the bolt or to load and unload the rifle with the safety engaged.
- Cold hammer-forged barrel results in ultra-precise rifling that provides exceptional accuracy and longevity.
- Shallow "express-style" windage-adjustable V-notch rear sight and large white bead front sight for instant target acquisition.
- Integral scope mounts, machined directly on the solid-steel receiver, provide a stable mounting surface for included scope rings, eliminating a potential source of looseness and inaccuracy in the field.
- Ergonomically pleasing, American walnut stock has rounded contours along the barrel, on the bottom of the stock and on top of the pistol grip and wrap-around checkering on the grip and forend.
- Rugged, one-piece, stainless steel bolt.
- Also includes: barrel band mounted swivel stud; optional forend swivel stud.



Hawkeye® African in .375 Ruger
(Model 37186)

Model Number	COMPARE										
	Caliber	Capacity	Material/Finish	Stock	Sights	Barrel Length	Overall Length	Weight	Length of Pull	Twist	Suggested Retail
47119	300 Win Mag	3	Alloy Steel/ Satin Blued	American Walnut with Ebony Forend Cap	Bead Front, Adjustable Rear	23"	44.88"	8 lbs.	13.50"	1:10"	\$1,279.00
47120	338 Win Mag	3	Alloy Steel/ Satin Blued	American Walnut with Ebony Forend Cap	Bead Front, Adjustable Rear	23"	44.88"	8 lbs.	13.50"	1:10"	\$1,279.00
37186	375 Ruger	3	Alloy Steel/ Satin Blued	American Walnut with Ebony Forend Cap	Bead Front, Adjustable Rear	23"	44.88"	8 lbs.	13.50"	1:12"	\$1,279.00
47121 LH	375 Ruger	3	Alloy Steel/ Satin Blued	American Walnut with Ebony Forend Cap	Bead Front, Adjustable Rear	23"	44.88"	8 lbs.	13.50"	1:12"	\$1,279.00
37185	416 Ruger	3	Alloy Steel/ Satin Blued	American Walnut with Ebony Forend Cap	Bead Front, Adjustable Rear	23"	44.88"	7.8 lbs.	13.50"	1:14"	\$1,279.00



American Walnut Stock with
Ebony Forend Cap



Ruger® Muzzle Brake System



Hinged, Solid-Steel Floorplate
for Easy Unloading



Bead Front Sight and "Express-Style"
Windage-Adjustable Rear Sight



FEATURES

- Non-rotating, Mauser-type controlled round feed extractor is among the most positive case extraction systems ever invented, and features a fixed blade-type ejector that positively ejects empty cases as the bolt is moved fully rearward.
- Hinged, solid-steel floorplate for easy unloading without having to chamber each cartridge. Features an engraved Ruger logo and patented latch that is flush with the trigger guard to avoid accidental dumping of cartridges.
- Three-position safety is easily accessible and allows the shooter to lock the bolt or to load and unload the rifle with the safety engaged.
- Cold hammer-forged barrel results in ultra-precise rifling that provides exceptional accuracy and longevity.
- Integral scope mounts, machined directly on the solid-steel receiver, provide a stable mounting surface for included scope rings, eliminating a potential source of looseness and inaccuracy in the field.
- Ergonomically pleasing stock has rounded contours along the barrel, on the bottom of the stock and on top of the pistol grip and wrap-around checkering on the grip and forend.
- Rugged, one-piece, stainless steel bolt.
- Also includes: studs for mounting sling swivels.

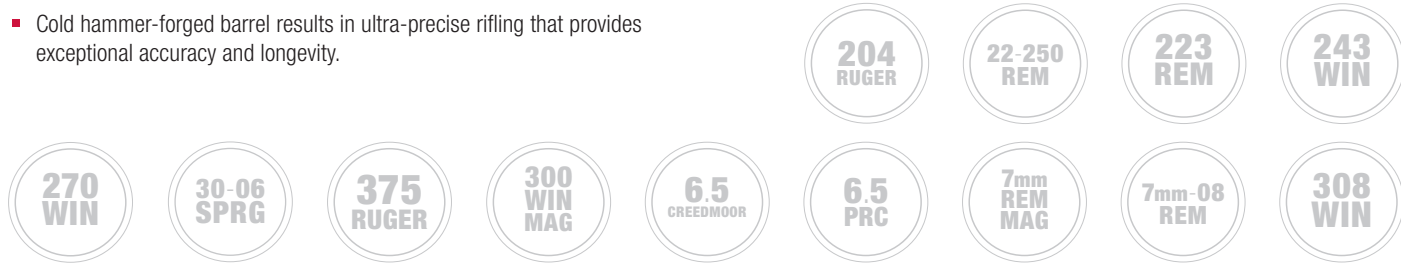

Integral Scope Mounts

Hinged, Solid-Steel Floorplate

Non-Rotating, Mauser-Type Controlled Round Feed Extractor

Three-Position Safety

HAWKEYE® STANDARD



Model 37117 Shown

LC6™ Trigger for Increased Accuracy

Red Rubber Buttpad for Recoil Reduction

American Walnut Stock

Model Number	Caliber	Capacity	Material/Finish	Stock	Sights	Barrel Length	Overall Length	Weight	Length of Pull	Twist	Suggested Retail
37116	204 Ruger	5	Alloy Steel/Satin Blued	American Walnut	None	24"	44"	7.2 lbs.	13.50"	1:12"	\$979.00
37117	223 Rem	5	Alloy Steel/Satin Blued	American Walnut	None	22"	42"	7.2 lbs.	13.50"	1:9"	\$979.00
37119	243 Win	4	Alloy Steel/Satin Blued	American Walnut	None	22"	42"	7 lbs.	13.50"	1:9"	\$979.00
37121	270 Win	4	Alloy Steel/Satin Blued	American Walnut	None	22"	42.75"	8 lbs.	13.50"	1:10"	\$979.00
37122	7mm Rem Mag	3	Alloy Steel/Satin Blued	American Walnut	None	24"	44.75"	8.2 lbs.	13.50"	1:9.5"	\$979.00
37123	7mm-08 Rem	4	Alloy Steel/Satin Blued	American Walnut	None	22"	42"	7 lbs.	13.50"	1:9.5"	\$979.00
37125	30-06 Sprg	4	Alloy Steel/Satin Blued	American Walnut	None	22"	42.75"	7.5 lbs.	13.50"	1:10"	\$979.00
37126	300 Win Mag	3	Alloy Steel/Satin Blued	American Walnut	None	24"	44.75"	8 lbs.	13.50"	1:10"	\$979.00
37124	308 Win	4	Alloy Steel/Satin Blued	American Walnut	None	22"	42"	7 lbs.	13.50"	1:10"	\$979.00

HAWKEYE® LAMINATE COMPACT



Model 17111 Shown

LC6™ Trigger for Increased Accuracy

Black Laminare Stock

Model Number	Caliber	Capacity	Material/Finish	Stock	Sights	Barrel Length	Overall Length	Weight	Length of Pull	Twist	Suggested Retail
17108	243 Win	4	Stainless Steel/Hawkeye Matte Stainless	Black Laminare	None	16.50"	35.50"	6.2 lbs.	12.50"	1:9"	\$1,069.00
17111	7mm-08 Rem	4	Stainless Steel/Hawkeye Matte Stainless	Black Laminare	None	16.50"	35.50"	6.2 lbs.	12.50"	1:9.5"	\$1,069.00
17110	308 Win	4	Stainless Steel/Hawkeye Matte Stainless	Black Laminare	None	16.50"	35.50"	6 lbs.	12.50"	1:10"	\$1,069.00

HAWKEYE® VARMINT TARGET

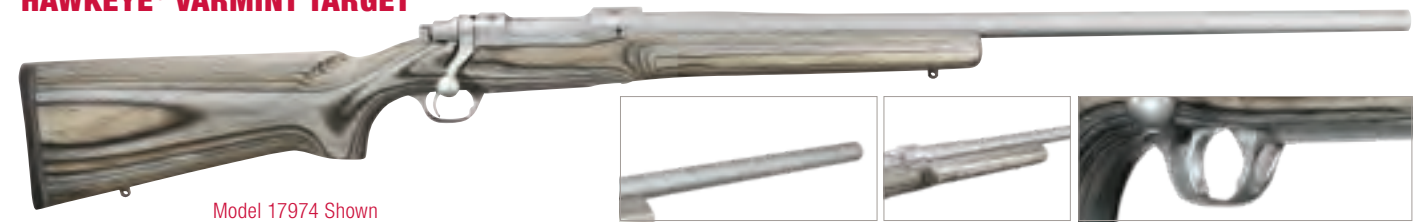

Model 17974 Shown

Heavy Contour, Cold Hammer-Forged Barrel with Target Crown

Target Forend

Unique, Two-Stage, Adjustable Target Trigger (Not LC6™ Trigger)

Model Number	Caliber	Capacity	Material/Finish	Stock	Sights	Barrel Length	Overall Length	Weight	Length of Pull	Twist	Suggested Retail
17974	204 Ruger	5	Stainless Steel/Hawkeye Matte Stainless	Black Laminare	None	26"	46"	9.7 lbs.	13.50"	1:12"	\$1,139.00
17976	22-250 Rem	4	Stainless Steel/Hawkeye Matte Stainless	Black Laminare	None	26"	46"	9.7 lbs.	13.50"	1:14"	\$1,139.00
17975	223 Rem	5	Stainless Steel/Hawkeye Matte Stainless	Black Laminare	None	26"	46"	9.7 lbs.	13.50"	1:9"	\$1,139.00
17980	6.5 Creedmoor	4	Stainless Steel/Hawkeye Matte Stainless	Black Laminare	None	28"	48"	9.5 lbs.	13.50"	1:8"	\$1,139.00
17979	308 Win	4	Stainless Steel/Hawkeye Matte Stainless	Black Laminare	None	26"	46"	9.2 lbs.	13.50"	1:10"	\$1,139.00

HAWKEYE® LONG-RANGE TARGET



Model 47184 Shown **NEW**

Unique, Two-Stage, Adjustable Target Trigger (Not LC6™ Trigger)

Heavy-Contour, Target Barrel Featuring Ruger® Hybrid Muzzle Brake

20 MOA Picatinny Rail

Two-Way Adjustable Comb

Model Number	Caliber	Capacity	Material/Finish	Stock	Sights	Barrel Length	Overall Length	Weight	Length of Pull	Thread Pattern	Twist	Suggested Retail
47183	300 Win Mag	5	Alloy Steel/Matte Black	Speckled Black/Brown Laminare	None	26"	47.50"-49"	11 lbs.	13"-14.50"	5/8"-24	1:9"	\$1,279.00
NEW 47184	6.5 Creedmoor	10	Alloy Steel/Matte Black	Speckled Black/Brown Laminare	None	26"	47"-48.50"	11 lbs.	13"-14.50"	5/8"-24	1:8"	\$1,279.00
NEW 47189	6.5 PRC	3	Alloy Steel/Matte Black	Speckled Black/Brown Laminare	None	26"	47"-48.50"	11 lbs.	13"-14.50"	5/8"-24	1:8"	\$1,279.00

HAWKEYE® PREDATOR

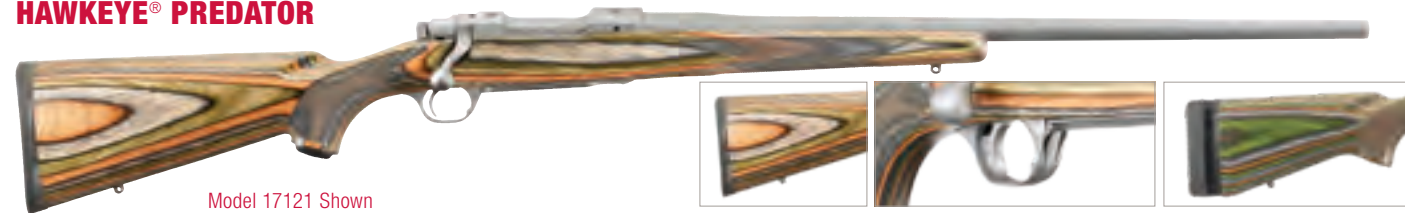

Model 17121 Shown

Green Mountain Laminate Stock

Unique, Two-Stage, Adjustable Target Trigger (Not LC6™ Trigger)

Model 47139 Features an Adjustable Length of Pull

Model Number	COMPARE		Material/Finish	Stock	Sights	Barrel Length	Overall Length	Weight	Length of Pull	Twist	Suggested Retail
	Caliber	Capacity									
17123	204 Ruger	5	Stainless Steel/Hawkeye Matte Stainless	Green Mountain Laminate	None	24"	44"	8 lbs.	13.50"	1:12"	\$1,139.00
17121	22-250 Rem	4	Stainless Steel/Hawkeye Matte Stainless	Green Mountain Laminate	None	24"	44"	8 lbs.	13.50"	1:14"	\$1,139.00
17122	223 Rem	5	Stainless Steel/Hawkeye Matte Stainless	Green Mountain Laminate	None	22"	42"	7.7 lbs.	13.50"	1:9"	\$1,139.00
47108	6.5 Creedmoor	4	Stainless Steel/Hawkeye Matte Stainless	Green Mountain Laminate	None	24"	44"	8.1 lbs.	13.50"	1:8"	\$1,139.00
47139	6.5 Creedmoor	4	Stainless Steel/Hawkeye Matte Stainless	Green Mountain Laminate	None	24"	43.25"-44.75"	8.1 lbs.	12.75"-14.25"	1:8"	\$1,159.00

HAWKEYE® FTW HUNTER



Model 47170 Shown

LC6™ Trigger for Increased Accuracy

Natural Gear™ Camo Hardwood Stock with Adjustable Length of Pull

Ruger® Muzzle Brake System for Reduced Felt Recoil

Model Number	COMPARE		Material/Finish	Stock	Sights	Barrel Length	Overall Length	Weight	Length of Pull	Thread Pattern	Twist	Suggested Retail
	Caliber	Capacity										
47146	300 Win Mag	3	Stainless Steel/Hawkeye Matte Stainless	Natural Gear™ Camo Hardwood	None	24"	43.25" - 44.75"	8.2 lbs.	12.75" - 14.25"	1/2"-24	1:10"	\$1,279.00
47166	375 Ruger	3	Stainless Steel/Hawkeye Matte Stainless	Natural Gear™ Camo Hardwood	None	22"	41.25" - 42.75"	7.8 lbs.	12.75" - 14.25"	5/8"-18	1:12"	\$1,269.00
47170	6.5 Creedmoor	4	Stainless Steel/Hawkeye Matte Stainless	Natural Gear™ Camo Hardwood	None	24"	43.25" - 44.75"	7.6 lbs.	12.75" - 14.25"	1/2"-24	1:8"	\$1,279.00
47174 LH	6.5 Creedmoor	4	Stainless Steel/Hawkeye Matte Stainless	Natural Gear™ Camo Hardwood	None	24"	43.25" - 44.75"	7.6 lbs.	12.75" - 14.25"	1/2"-24	1:8"	\$1,279.00
47175 LH	300 Win Mag	3	Stainless Steel/Hawkeye Matte Stainless	Natural Gear™ Camo Hardwood	None	24"	43.25" - 44.75"	8.2 lbs.	12.75" - 14.25"	1/2"-24	1:10"	\$1,279.00

LH: Left-Handed.





77-SERIES RIFLES

In 1983, Ruger responded to the many shooters who desired a high-quality, adult-size .22 LR rimfire rifle – one that was built to centerfire standards of strength, accuracy and aesthetics. Focused on building a rifle that was accurate, economical and extremely handsome, Bill Ruger launched the rotary magazine fed **77-Series** of bolt-action rifles.



77-SERIES RIFLES



17
HORNET

17
WSM

22
HORNET

357
MAG

44
REM
MAG

FIVE CALIBERS

NINE MODELS

RUGER
77/17®

RUGER
77/22®

RUGER®
77/357™

RUGER
77/44®

NEW

Ruger 77/17® in .17 WSM
with Green Mountain
Laminate Stock and
Stainless Finish
(Model 7218)

NEW

Ruger 77/17® in .17 WSM
with American Walnut Stock
and Blue Finish
(Model 7217)

77-SERIES

FEATURES

- Features a rugged, stainless steel bolt with 90° bolt throw and rapid lock time for added accuracy.
- Detachable rotary magazine features a unique rotor to separate cartridges and provide reliable feeding. Mounts flush with the stock to eliminate protrusions at the rifle's balance point.
- Cold hammer-forged barrel results in ultra-precise rifling that provides exceptional accuracy and longevity.
- Integral scope mounts, machined directly on the solid-steel receiver, provide a stable mounting surface for included scope rings, eliminating a potential source of looseness and inaccuracy in the field.
- Three-position safety is easily accessible and allows the shooter to lock the bolt to load and unload the rifle with the safety engaged.
- Also includes: sling swivel studs.



Stainless Steel Bolt with 90° Throw



Three-Position Safety



Detachable Rotary Magazine



Integral Scope Mounts

RUGER 77/17®



Model 7217 Shown

Matte Stainless or Blued Finish

American Walnut or Green Mountain Laminate Stock

Model Number	COMPARE		Material/Finish	Stock	Sights	Barrel Length	Overall Length	Weight	Length of Pull	Twist	Suggested Retail
	Caliber	Capacity									
7212	17 Hornet	6	Stainless Steel/ Matte Stainless	Green Mountain Laminate	None	24"	43.25"	7.5 lbs.	13.50"	1:9"	\$1,069.00
NEW 7217	17 WSM	6	Alloy Steel/ Blued	American Walnut	None	20"	39.25"	5.7 lbs.	13.50"	1:9"	\$999.00
NEW 7218	17 WSM	6	Stainless Steel/ Matte Stainless	Green Mountain Laminate	None	18.50"	37.75"	7 lbs.	13.50"	1:9"	\$1,069.00

RUGER 77/22®



Model 7204 Shown

Matte Stainless or Blued Finish

American Walnut or Green Mountain Laminate Stock

Model Number	Caliber	Capacity	COMPARE		Sights	Barrel Length	Overall Length	Weight	Length of Pull	Twist	Suggested Retail
			Material/Finish	Stock							
7201	22 Hornet	6	Alloy Steel/ Blued	American Walnut	None	20"	39.25"	6.5 lbs.	13.50"	1:14"	\$999.00
7204	22 Hornet	6	Stainless Steel/ Matte Stainless	Green Mountain Laminate	None	24"	43.25"	7.5 lbs.	13.50"	1:14"	\$1,069.00

RUGER® 77/357™



Gold Bead Front and Adjustable Rear Sights

Model Number	Caliber	Capacity	Material/Finish	Stock	Sights	Barrel Length	Overall Length	Weight	Length of Pull	Twist	Suggested Retail
7405	357 Mag	5	Stainless Steel/ Brushed Stainless	Black Synthetic	Gold Bead Front, Adjustable Rear	18.50"	38.50"	5.5 lbs.	13.50"	1:16"	\$999.00

RUGER 77/44® with American Walnut Stock



Bead Front and Adjustable Rear Sights

Model Number	Caliber	Capacity	Material/Finish	Stock	Sights	Barrel Length	Overall Length	Weight	Length of Pull	Twist	Suggested Retail
7401	44 Rem Mag	4	Alloy Steel/ Blued	American Walnut	Bead Front, Adjustable Rear	18.50"	38.50"	5.2 lbs.	13.50"	1:20"	\$999.00

RUGER 77/44® with Black Synthetic Stock



Model 7402 Shown

Bead Front and Adjustable Rear Sights

Brushed Stainless or Blued Finish

Model Number	Caliber	Capacity	COMPARE		Sights	Barrel Length	Overall Length	Weight	Length of Pull	Twist	Suggested Retail
			Material/Finish	Stock							
7402	44 Rem Mag	4	Stainless Steel/ Brushed Stainless	Black Synthetic	Bead Front, Adjustable Rear	18.50"	38.50"	5.2 lbs.	13.50"	1:20"	\$999.00
7403	44 Rem Mag	4	Alloy Steel/ Blued	Black Synthetic	Bead Front, Adjustable Rear	18.50"	38.50"	5.2 lbs.	13.50"	1:20"	\$939.00



No.1

When you only have one shot, make it count. When you think of single-shot rifles, think of the best – think **Ruger® No.1**. The No.1 rifle is made for virtually every sporting activity.



No.1 with American Walnut Stock in .450 Marlin (Model 21313)



No.1 in .450 Bushmaster (Model 21304)

No.1 in .450 Marlin (Model 21313)

No.1 RIFLES



TWO CALIBERS

TWO MODELS

CLASSIC SINGLE-SHOT

FEATURES

- Sliding tang safety provides instant security, visibility and accessibility.
- Strong, simple, compact falling block breech mechanism with artillery-style breechblock and under-lever is ideally suited for powerful cartridges.
- Robust, sturdy, sculptured receiver forms a rigid support for barrel, stock and sliding breech block.
- Ejector mechanism provides maximum leverage at the point where the ejector engages the cartridge case and can be adjusted to provide extraction only.
- Integral scope mounts, machined directly on the solid steel quarter rib, provide a stable mounting surface for included scope rings.
- Cold hammer-forged barrel results in ultra-precise rifling that provides exceptional accuracy and longevity.
- Also Includes: sporting style buttpad; sling swivel studs.

Model Number	COMPARE		Material/Finish	Stock	Sights	Barrel Feature	Barrel Length	Overall Length	Weight	Length of Pull	Thread Pattern	Twist	Suggested Retail
	Caliber	Capacity											
21304	450 Bushmaster	1	Stainless Steel/Satin Stainless	Black Laminate	None	Ruger® Hybrid Muzzle Brake	20"	36.50"	7.5 lbs.	13.50"	11/16"-24	1:16"	\$1,899.00
21313	450 Marlin	1	Alloy Steel/Satin Blued	American Walnut	Blade	–	20"	36.50"	7.1 lbs.	13.50"	–	1:16"	\$1,899.00

RUGER® RIFLE MAGAZINES

	10/22, 10/22 TAKEDOWN	PC CARBINE	AR-556	MINI-14	MINI THIRTY	RUGER PRECISION RIFLE	RUGER PRECISION RIFLE	RUGER PRECISION RIFLE 22 LR	RUGER AMERICAN RIFLE	RUGER AMERICAN RIFLE	RUGER AMERICAN RIFLE 22 LR	SCOUT RIFLE	Item No.	Price
1-Round, 22 LR Magazine	•					•			•				90344	\$21.95
5-Round, 22 LR Magazine	•					•			•				90041	\$21.95
10-Round, 22 LR Magazine	•					•			•				90005	\$21.95
10-Round, 22 LR Magazine (3-Pack)	•					•			•				90451	\$47.95
10-Round, 22 LR Magazine (Clear)	•					•			•				90223	\$24.95
15-Round, 22 LR Magazine	•					•			•				90463	\$28.95
25-Round, 22 LR Magazine	•					•			•				90361	\$33.95
25-Round, 22 LR Magazine (2-Pack)	•					•			•				90548	\$51.95
25-Round, 22 LR Magazine (Clear-Sided)	•					•			•				90591	\$39.95
2x25-Round, 22 LR Magazine	•					•			•				90398	\$58.95
9-Round, 22 WMR/17 HMR Magazine										•			90076	\$24.95
15-Round, 22 WMR/17 HMR Magazine							•						90585	\$29.95
4-Round, Short-Action Magazine (22-250 Rem)								•					90573	\$39.95
4-Round, Short-Action Magazine (243 Win/308 Win/7mm-08 Rem/6.5 Creedmoor)								•					90436	\$39.95
5-Round, Short-Action Magazine (223 Rem/5.56 NATO/204 Ruger/300 BLK)								•					90440	\$39.95
5-Round, 223 Rem Magazine				•									90009	\$29.95
10-Round, 223 Rem Magazine				•									90339	\$39.95
20-Round, 223 Rem Magazine				•									90010	\$39.95
30-Round, 223 Rem Magazine				•									90035	\$49.95
5-Round, 5.56 NATO/223 Rem Magazine			•					•					90428	\$24.95
10-Round, 5.56 NATO/223 Rem Magazine			•					•					90384	\$19.95
10-Round, 5.56 NATO/223 Rem Magazine											•		90458	\$74.95
30-Round, 5.56 NATO/223 Rem Magazine			•										90420	\$19.95
10-Round, AI-Style Magazine (5.56 NATO)					•							•	90562	\$39.95
4-Round, Long-Action Magazine (270 Win/30-06 Sprg)								•					90435	\$39.95
3-Round, Magnum Magazine (7mm Rem Mag/300 Win Mag)								•					90549	\$49.95
3-Round, Magnum Magazine (7mm Rem Mag/300 Win Mag)		•											90549	\$49.95
5-Round, 300 BLK Magazine				•									90583	\$29.95
10-Round, 300 BLK Magazine				•									90584	\$39.95
20-Round, 300 BLK Magazine				•									90484	\$39.95

	10/22, 10/22 TAKEDOWN	PC CARBINE	AR-556	MINI-14	MINI THIRTY	RUGER PRECISION RIFLE	RUGER PRECISION RIFLE	RUGER PRECISION RIFLE 22 LR	RUGER AMERICAN RIFLE	RUGER AMERICAN RIFLE	RUGER AMERICAN RIFLE 22 LR	SCOUT RIFLE	Item No.	Price
5-Round, 300 Win Mag Magazine					•								90682	\$84.95
5-Round, 7.62x39 Magazine				•				•					90012	\$29.95
10-Round, 7.62x39 Magazine				•				•					90485	\$39.95
20-Round, 7.62x39 Magazine				•				•					90338	\$39.95
5-Round, 308 Win/4-Round 450 Bushmaster Magazine					•						•		90352	\$69.95
5-Round, 308 Win Magazine											•		90354	\$39.95
10-Round, 308 Win Magazine					•						•		90353	\$74.95
20-Round, 308 Win/7.62 x 51/6.5 Creedmoor Magazine					•								90448	\$19.95
3-Round, AI-Style Magazine (308 Win/6.5 Creedmoor/243 Win)								•			•		90560	\$39.95
5-Round, AI-Style Magazine (308 Win/6.5 Creedmoor/243 Win)					•			•			•		90561	\$39.95
10-Round, AI-Style Magazine (308 Win/6.5 Creedmoor/243 Win)					•			•			•		90563	\$39.95
5-Round, 338 Lapua Magazine					•								90683	\$84.95
17-Round, 9mm Luger Magazine		•											90326	\$44.95
17-Round, 9mm Luger Magazine (2-Pack)		•											90449	\$57.95
10-Round, 9mm Luger Magazine		•											90325	\$44.95
17-Round, 9mm Luger Magazine (Nickel-Teflon)		•											90510	\$39.95
10-Round, 9mm Luger Magazine		•											90638	\$39.95
10-Round, 9mm Luger Magazine (Nickel-Teflon)		•											90514	\$39.95
10-Round, Ruger American® Pistol 9mm Luger Compact Magazine		•											90617	\$39.95
10-Round, SR9c® 9mm Luger Compact Magazine		•											90369	\$44.95
10-Round, Security-9® Compact 9mm Luger Magazine		•											90667	\$39.95
12-Round, Ruger American® Pistol 9mm Luger Compact Magazine		•											90618	\$39.95
15-Round, 9mm Luger Magazine		•											90637	\$39.95
5-Round, 6.8mm Magazine				•									90332	\$29.95
3-Round, 450 Bushmaster Magazine								•					90633	\$39.95
5-Round, MSR Magazine (.450 Bushmaster)			•										90679	\$42.95

	SECURITY-9	RUGER AMERICAN PISTOL DUTY	RUGER AMERICAN PISTOL COMPACT	SR1911	SR1911 OFFICER	EC9s	LC380CA	LCP	LCP II	SR22	MARK IV	MARK IV 22/45	22 CHARGER	Item No.	Price
1-Round, 22 LR Magazine													•	90344	\$21.95
5-Round, 22 LR Magazine													•	90041	\$21.95
10-Round, 22 LR Magazine													•	90005	\$21.95
10-Round, 22 LR Magazine (3-Pack)													•	90451	\$47.95
10-Round, 22 LR Magazine (Clear)													•	90223	\$24.95
10-Round, 22 LR Magazine												•		90599	\$29.95
10-Round, 22 LR Magazine											•			90231	\$29.95
10-Round, 22 LR Magazine (2-Pack)											•			90645	\$41.95
10-Round, 22 LR Magazine (2-Pack)												•		90646	\$41.95
10-Round, 22 LR Magazine with Extended Floorplate										•				90382	\$34.95
10-Round, 22 LR Magazine with Extended Floorplate (2-Pack)										•				90647	\$48.95
15-Round, 22 LR Magazine													•	90463	\$28.95
25-Round, 22 LR Magazine													•	90361	\$33.95
25-Round, 22 LR Magazine (2-Pack)													•	90548	\$51.95
25-Round, 22 LR Magazine (Clear-Sided)													•	90591	\$39.95
2x25-Round, 22 LR Magazine													•	90398	\$58.95
7-Round, 9mm Luger Magazine				•										90652	\$39.95
7-Round, 9mm Luger Magazine with Extended Floorplate					•									90363	\$39.95
7-Round, 9mm Luger Magazine with Extended Floorplate (2-Pack)					•									90642	\$55.95
9-Round, 9mm Luger Extended Magazine					•									90404	\$44.95
9-Round, 9mm Luger Magazine				•										90600	\$39.95
10-Round, 9mm Luger Magazine	•													90667	\$39.95
10-Round, 9mm Luger Magazine with Extended Floorplate (Nickel-Teflon®)			•											90617	\$39.95
10-Round, 9mm Luger Magazine (Nickel-Teflon®)		•												90514	\$39.95

	SECURITY-9	RUGER AMERICAN PISTOL DUTY	RUGER AMERICAN PISTOL COMPACT	SR1911	SR1911 OFFICER	EC9s	LC380CA	LCP	LCP II	SR22	MARK IV	MARK IV 22/45	22 CHARGER	Item No.	Price
10-Round, 9mm Luger Magazine	•													90638	\$39.95
10-Round, 9mm Luger Magazine (Competition Model Only)				•										90666	\$39.95
12-Round, 9mm Luger Magazine with Extended Floorplate (Nickel-Teflon®)			•											90618	\$39.95
15-Round, 9mm Luger Magazine	•													90637	\$39.95
15-Round, 9mm Luger Magazine & Adapter	•													90681	\$44.95
17-Round, 9mm Luger Magazine (Nickel-Teflon®)		•												90510	\$39.95
8-Round, 10mm Auto Magazine				•										90639	\$39.95
6-Round, 380 Auto Magazine with Extended Floorplate								•	•					90621	\$34.95
6-Round, 380 Auto Magazine with Extended Floorplate (2-Pack)								•	•					90644	\$48.95
6-Round, 380 Auto Magazine with Extended Floorplate								•	•					90333	\$34.95
6-Round, 380 Auto Magazine with Extended Floorplate (2-Pack)								•	•					90643	\$48.95
7-Round, 380 Auto Extended Magazine								•						90405	\$39.95
7-Round, 380 Auto Extended Magazine									•					90626	\$39.95
7-Round, 380 Auto Magazine with Extended Floorplate							•							90416	\$39.95
7-Round, 45 Auto Magazine				•										90366	\$29.95
7-Round, 45 Auto Magazine (Officer Model Only)				•										90664	\$29.95
7-Round, 45 Auto Magazine with Extended Floorplate (Nickel-Teflon®)			•											90636	\$39.95
8-Round, 45 Auto Magazine				•										90365	\$39.95
10-Round, 45 Auto Magazine (Nickel-Teflon®)		•												90512	\$39.95

9mm RUGER AMERICAN® PISTOL PRODUCT SAFETY BULLETIN: Ruger has discovered that some Ruger American® Pistols chambered in 9mm may exhibit premature wear of the locking surfaces between the slide and barrel which, if ignored, can result in a crack developing near the ejection port of the slide. This typically does not occur at round counts below 10,000 rounds. The condition is easily identified during routine maintenance and cleaning and the crack should be visible long before the pistol becomes unsafe to shoot. Ruger is committed to safety and is asking owners of Ruger American® Pistols chambered in 9mm to inspect their pistols for excessive wear or cracks and, if necessary, sign up for this retrofit. Details about what to look for and how to sign up for the retrofit appear below and on our website at Ruger.com/APRetrofit.

Ruger American® Pistols chambered in .45 Auto are NOT subject to this Safety Bulletin. Similarly, other Ruger® pistols chambered in 9mm (for example, SR9®, LC9s®, etc.) are NOT subject to this Safety Bulletin.

Products Subject to This Safety Bulletin: Ruger American® Pistols chambered in 9mm with serial number prefixes "860" and "862" are subject to this Safety Bulletin. These include duty (full-sized) and compact models, in both Manual Safety and Pro (no manual safety) configurations. One easy way to tell if your pistol is subject to this Safety Bulletin is by looking at the barrel. If your 9mm Ruger American® Pistol is equipped with a silver-colored, stainless steel barrel, you should follow the inspection procedure outlined below. Retrofitted and newly manufactured Ruger American® Pistols will be equipped with a black, nitrided stainless steel barrel.

Description of the Issue: In some instances (typically at round counts in excess of 10,000 rounds), the locking surfaces between the slide and barrel can experience excessive wear. If ignored, this condition will worsen and can result in a crack developing near the ejection port of the slide. If cracking occurs, it will become visible long before an unsafe condition develops. However, if the crack is not addressed and the pistol remains in service, the pistol may eventually fail to function or become unsafe to shoot.

How To Inspect Your Pistol: If your pistol is dirty, clean it thoroughly before performing the inspection. Disassembly and cleaning instructions appear in your instruction manual, which is available online at Ruger.com/Service/ProductHistory. Inspect your pistol, paying particular attention to the barrel/slide lockup surfaces and the sidewalls of the slide at the corners of the ejection port. If you observe excess wear in the lockup surfaces (A and B) or a crack in the slide (C), you should immediately stop using your pistol and sign up for the retrofit. If you are unsure, we recommend that you sign up for the retrofit and allow us to inspect your barrel/slide assembly. If you do not observe excess wear in the lockup surface or a crack in the slide, no further action on your part is necessary at this time. Nonetheless, you should continue to monitor these areas and, if you suspect that either of these conditions is developing, sign up for the retrofit or contact Customer Service. *Ruger reminds consumers that periodic inspection of any firearm is important to ensuring its safe operation. You should clean and inspect your firearm after each range session. Proper maintenance increases the longevity of your firearm and will allow early detection of worn or broken parts.*

How To Sign Up For The Retrofit:

STEP 1: If you detect or suspect excess wear in the locking surfaces or a crack in the slide, or if you are uncertain, please visit the Ruger American® Pistol Retrofit Website at Ruger.com/APRetrofit and sign up to return your barrel/slide assembly to Ruger. You will be asked to provide your name, address, and telephone number, an email address, and the serial number of your pistol. You will be added to a list to have the inspection and retrofit performed on a first-come, first-served basis.

STEP 2: In the next few weeks, you will receive a USPS box with a prepaid shipping label and detailed packaging and shipping instructions. Follow the instructions and return only your barrel/slide assembly.

STEP 3: We will inspect your barrel/slide assembly and install new components as needed, **FREE OF CHARGE**. We will make every effort to return your barrel/slide assembly within one week of the day we receive it.

MARK IV™ RECALL NOTICE: We have determined that all Mark IV™ pistols (including 22/45™ models) manufactured prior to June 1, 2017 have the potential to discharge unintentionally if the safety is not utilized correctly. In particular, if the trigger is pulled while the safety lever is midway between the "safe" and "fire" positions (that is, the safety is not fully engaged or fully disengaged), then the pistol may not fire when the trigger is pulled. However, if the trigger is released and the safety lever is then moved from the mid position to the "fire" position, the pistol may fire at that time. Although only a small percentage of pistols appear to be affected and we are not aware of any injuries, Ruger is firmly committed to safety and would like to retrofit all potentially affected pistols with an updated safety mechanism. **Until your Mark IV™ pistol has been retrofitted or you verify that it is not subject to the recall, we strongly recommend that you not use your pistol.**

How to determine if your pistol needs the retrofit: All Mark IV™ pistols produced prior to June 1, 2017 are potentially affected and therefore are being recalled. This includes Mark IV™ Target, Hunter, Competition, 22/45™, 22/45™ Lite and 22/45™ Tactical models. These models bear serial numbers beginning with "401" (2017 models) or "WBR" (2016 models). Mark I, Mark II™ and Mark III™ Pistols are **NOT** affected.

Newly manufactured Mark IV™ pistols will begin with serial number "500." Thus, if you have a Mark IV™ or 22/45™ pistol with a serial number beginning with the number "5," your pistol is not subject to the recall.

Mark IV™ and 22/45™ pistols retrofitted with the updated safety mechanism are easily identified by the letter "S" in the white safety dot that is visible when the safety is engaged.

Visit the Mark IV™ Recall website at Ruger.com/MarkIVRecall to look up your serial number and verify if it is subject to the recall. Please have the unloaded pistol available when you visit the website and obtain the serial number directly from the pistol.

Next steps (if your pistol is affected):

STEP 1: Follow the instructions at the Mark IV™ Recall Website and sign up for the recall. You will be asked to provide your name, address, telephone number, an e-mail address and the serial number of your pistol.

STEP 2: You will be added to a list to have the retrofit installed on a first-come, first-served basis. In the next few weeks, you will receive a prepaid USPS box with a shipping label and detailed packaging and shipping instructions. Simply follow the instructions in your instruction manual to separate the barrel/receiver assembly and return the grip frame assembly to us in accordance with the shipping instructions.

STEP 3: We will install the updated safety mechanism, and return your grip frame assembly to you, all **FREE** of charge. Individual consumers will receive a **FREE** magazine (a \$29.95 value) as a "thank you" for their patience and cooperation. (Customers in states with magazine shipping restrictions will receive a ShopRuger gift certificate in lieu of a magazine.) We will make every effort to return your pistol within one week of the day we receive it.

We recognize that this is an inconvenience so, as a thank you, we will include an extra magazine at no charge to you when we return the pistol.*



LCP® RECALL NOTICE: In 2008, Ruger received a small number of reports from the field indicating that LCP® pistols could discharge when dropped onto a hard surface with a round in the chamber. We are firmly committed to safety and would like to retrofit all affected LCP® pistols. The retrofit involves installation of an upgraded hammer mechanism at no charge to the customer.

We want to remind gun users that, for maximum safety when carrying any pistol with a loaded magazine in place, the chamber should be empty, and the slide should be closed. Any gun may fire if dropped or struck.



How to determine if your pistol needs the retrofit: Any LCP® pistol bearing prefix "370" (that is, serial number 370-xxxx) may be affected. Retrofitted "370" prefix LCP® pistols with the new hammer mechanism installed have been marked with a diamond in the flat portion of the slot just behind and below the hammer, as shown to the right. If your pistol has the diamond, it does not need the retrofit. Any LCP® marked with the serial number prefix "371" (serial number 371-xxxx) or higher is not affected. When we return your pistol, we also will send you a FREE magazine *with the new finger grip extension* as a "thank you" for your patience and cooperation. Visit RUGER.COM/LCPRECALL for more information.

SR9® RECALL NOTICE: We have determined that some Ruger® SR9® pistols manufactured between October 2007 and April 2008 can, under certain conditions, fire if dropped with their manual safeties in the "off" or "fire" position. The pistols will not fire if the manual safety is in the "on" or "safe" position.

We designed a replacement trigger group which prevents firing when dropped and retrofits all affected Ruger® SR9® pistols at no charge. This retrofit only applies to SR9® pistols with serial number prefix "330" (330-xxxx) and these new parts at NO CHARGE to our customers. When we return your pistol, we also will send you a FREE magazine as a "thank you" for your patience and cooperation*.



In order to ensure correct fitting, the new parts must be installed at our Ruger factory in Prescott, Arizona. We will remove the old parts and install the new trigger group promptly, at no charge, and will return the pistol to you. The old parts will not be returned. Visit RUGER.COM/SR9RECALL for more information.

For additional product, safety or service information, please visit RUGER.COM

AN IMPORTANT FREE SAFETY OFFER FROM RUGER:

Do you own an "old model" (pre-1973) Ruger® Single-Six®, Blackhawk®, Super Blackhawk® or Bearcat® single-action revolver like these?



Three frame screws identify the "old model" Single-Six®, Blackhawk®, and Super Blackhawk® made from 1953 to 1972.



Serial numbers below 93-00000 identify old Bearcat® and Super Bearcat® models made from 1958-1972.

Three frame screws identify the "old model" Single-Six®, Blackhawk® and Super Blackhawk® made from 1953 to 1972. Serial numbers below 93-00000 identify old Bearcat® and Super Bearcat® models made from 1958-1972.

The Ruger® Conversion Kit is an entirely new operating system for these revolvers. **It can help prevent accidental discharges caused by a drop or blow to the hammer if the user has failed to take the basic safety precaution of keeping the hammer down on an empty chamber. That's very important!**

This mechanism can be factory-installed in "old model" revolvers without any further alteration. The frame and other major parts will not be affected by this conversion. The value of the gun will not be impaired, and we will return your original parts for collector's purposes.

To receive a free factory safety conversion, write to us at Sturm, Ruger and Company, Inc.; 411 Sunapee Street Newport, NH 03773 or call 336-949-5200. We will provide you with a shipping container and instructions. You only pay initial shipping to our factory. We will cover all other charges including return shipping costs. Please write to us without delay if you have one of these guns, and tell your friends about the availability of this kit. Remember that the safest way to carry any older single-action revolver, regardless of manufacturer, is with the hammer down on an **empty** chamber.

PLEASE WRITE TO US AT:
Ruger / Conversion Department / 411 Sunapee Street / Newport, NH 03773 or call 336-949-5200

For full details and a FREE shipping box. If your single-action revolver has the words "New Model," "Bisley" or "Vaquero" on the frame, this offer is not applicable.

NOTICE: Weights of all Ruger® firearms, and rifles in particular, may vary from the published weight because of variations in wood density, bore size, barrel length and style. All weights specified in this reference guide are approximate. In some instances, length, width or height dimensions may have been rounded or truncated. All ammunition that appears in this reference guide is shown actual size only when noted. Sturm, Ruger & Co., Inc. does not manufacture scopes, optics or lasers. Scopes, optics and lasers are not included with any firearm purchase unless specifically noted.

All specifications and prices are subject to change without notice. Sturm, Ruger & Co., Inc. reserves the right to change the prices, specifications or availability of its products at any time without notice.

Typographic, photographic and/or descriptive errors are subject to correction. We apologize for any inconvenience.

The following are registered trademarks of Sturm, Ruger & Co., Inc.: 9E; 10/22; 10/22 Takedown; AC-556; All-Weather; AR-556; Arms Makers For Responsible Citizens; Bearcat; Blackhawk; BX-15; BX-25; BX-Trigger; EC9s; Elite 452; Everything You Need and Nothing You Don't; GP100; Hawkeye; It's Mine and It's American; It's Mine. And It's American.; LC380; LC9; LC9s; LCP; LCR; LCRx; M77; Match Champion; Mini-14; Mini Thirty; Old Army; Power Bedding; Redhawk; Ruger; Ruger 22/45 Lite; Ruger 77/17; Ruger 77/22; Ruger 77/44; Ruger American; Ruger American Pistol; Ruger American Rifle; Ruger American Rimfire; Ruger Hunting; Ruger Inside & Out; Ruger Precision; Ruger Precision Rifle; Ruger Vaquero; Rugged, Reliable Firearms; Security-9; Silent-SR; Single-Nine; Single-Six; Single-Ten; SR1911; SR9; SR9c; SR22; SR-22; SR40; SR40c; SR-556; SR-556 Takedown; SR-762; Super Redhawk Alaskan.

The following are trademarks of Sturm, Ruger & Co., Inc.: 10/22-FS; 22 Charger; 22/45; 22/45 RP; 77/357; Bisley; Gold Label; I'm a Ruger American; LC380CA; LC6; LCR-357; Mark II; Mark III; Mark IV; Model 96; P345; P345D; P345PR; P85; P90; P91; P93; P94; P95; P97; PC Carbine; Ruger 10/17; Ruger 77/50; Ruger Marksman Adjustable; Ruger Titanium; R.I.O.S. (Ruger Inertia Operating System); Security-Six; Service-Six; Single-Seven; Speed-Six; SR45; SR-556c; SR-556VT; Super Bearcat; Target Grey; This is Ruger. This is America.; Train. Compete. Defend.; Tri-Flex.

* For Connecticut residents only, we will send you a ShopRuger.com gift certificate in lieu of the magazine.



RUGER CUSTOMER SERVICE

Service inquiries for all firearms, sportswear and accessories: **336-949-5200** / Ruger.com/CustomerService

INDEPENDENT DISTRIBUTORS OF RUGER BRANDED PRODUCTS

BANGERS L.P.
800-226-4377 | bangersusa.com

BIG ROCK SPORTS, LLC
800-334-2661 | bigrocksports.com

BILL HICKS & CO., LTD.
800-223-0702 | billhicksco.com

CAMFOUR, INC.
800-347-3276 | camfour.com

CHATTANOOGA SHOOTING SUPPLIES, INC.
800-251-4808 | chattanoogashooting.com

CROW SHOOTING SUPPLY
800-264-2493 | crowshootingssupply.com

DAVIDSON'S, INC.
800-367-4867 | davidsoninc.com

ELLETT BROTHERS, LLC
A Division of United Sporting Companies
800-845-3711 | ellettbrothers.com

GUNARAMA WHOLESALE, INC.
800-333-3006 | gunarama.com

HILL COUNTRY WHOLESALE, INC.
800-777-2666 | hillcountrywholesale.com

JERRY'S SPORT CENTER
A Division of United Sporting Companies
800-234-2612 | jerrysportscenter.com

LEW HORTON DISTRIBUTING CO., INC.
800-446-7866 | lewhorton.com

LIPSEY'S, LLC
800-666-1333 | lipseys.com

L.M. BURNEY DISTRIBUTORS, LLC
800-737-3006 | lmburney.com

OUTDOOR SPORTS
A Division of United Sporting Companies
800-444-6744 | jerrysportscenter.com

RSR GROUP, INC.
800-541-4867 | rsrgroup.com

SIMMON'S GUN
A Division of United Sporting Companies
800-444-0220 | jerrysportscenter.com

SPORTS SOUTH, LLC
800-388-3845
theshootingwarehouse.com

V.F. GRACE, INC.
907-272-6431
vfgrace.com/custport/index.htm

W.L. BAUMLER COMPANY, INC.
800-321-2501 | wlbco.com

WILLIAMS SHOOTERS SUPPLY, INC.
217-222-4195 | willshoot.com

ZANDERS SPORTING GOODS
800-851-4373 | gzanders.com





 **RUGER**
2019 FIREARMS CATALOG

RUGER.COM

