

TARMEKO

TARMEKO – European furniture manufacturer since 1947 – is located in Estonia. The country is well known for its beautiful nature and green landscape – about 50% of the land is covered with natural forest.

WOOD is ancient and magical material – already our ancestors valued its strength, warmth and diversity. Over the 60 years of existence Tarmeko's idea has been to carry the concept of wood design step by step to a higher level by passing from one generation to the other the craftsmanship of our dedicated artisans.

Tarmeko's furniture has always been made out of wood. Birch, beech or oak furniture can be found in almost every home in Europe. It is valued because it can last for centuries, maintaining its quality and fine look.

QUALITY and handcraft is what we value. By using only the best materials we seek perfection in each detail thus giving unique identity to every item we make. By adding value through constant development in design and technologies we have created several brands which carry the concept of timeless shapes and forms.

We unite natural wood and other natural materials like leather and fabric and produce luxurious pieces of furniture for people to indulge and enjoy.

OUR VISION is to create comfort in a timeless shape and form, based on long experience and innovative designs. Today we are one of the few companies in Europe, who produce:

- form pressed and layer glued furniture in birch veneer,
- luxurious sofa designs in modernized techniques.





HISTORY

Tarmeko enterprises are specialised in wood processing and furniture manufacturing. Both, production and management have always been located in Northern Europe, in Estonia.

The company originates from the year 1947. The company name **TARMEKO** withholds three important words: the location of the company in Estonia – the city of **TARTU**, the word “forest” – in Estonian **METS**, and the word “factory” – in Estonian **KOMBINAAT**. This is how our company got its name.

Tarmeko is a family owned company. The father and his two sons have been working in the factory and run the company since their early childhood. Today they all are highly respected businessmen.

Tarmeko has been among the top furniture producers in Estonia and has been given many prestigious awards. Over the years, tarmeko has made many innovative changes in the production and technology.

QUALITY & SAFETY

We are very concerned about the environmental protection and quality of materials. We support the reduction of humanity's ecological footprint by using environmentally friendly materials. We are linked to the FSC © C116426 Chain of Custody and we buy our wood from sustainable resources.

Tarmeko gives up to 20-year-warranty to the products. Our quality control system regulates the internal control procedure. We test our furniture for mechanical safety and examine the products before packaging and delivery.



FORSSA

Designer *Carlos Guijarro*



FORSSA SOFA is characterized by deep ample seats and medium-high backrest. The combination of square and slim outer body with thick and rounded cushions generate an impression of comfort at first sight. The essential idea behind Forssa sofa is to bring an extra pleasant and homey sofa for living experiences.

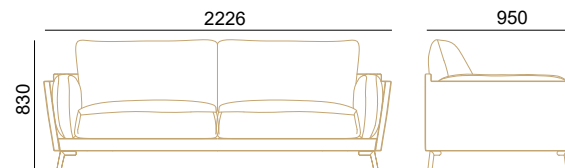

CURVE

Designer *Tobias Jacobsen*



CURVE has a long history behind its new design, which traces back to my background and childhood – I was brought up in my grandfather’s Arne Jacobsen “design universe”. It is important for me to embrace the family in a time, where the noise of technology and information surrounds us constantly. I believe Curve sofa gives, for example a meeting, a calm and silent atmosphere, due to it being a wonderful piece of craftsmanship with all the neverending lines, which truly yields a nice contribution in creating a splendid interior.

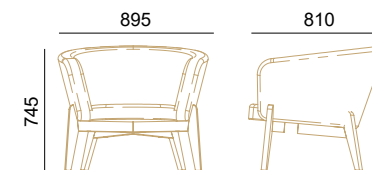

CURVE SOFA gives, for example, a meeting, a calm and silent atmosphere, due to it being a wonderful piece of craftsmanship with all the neverending lines, which truly yields a nice contribution in creating a splendid interior.

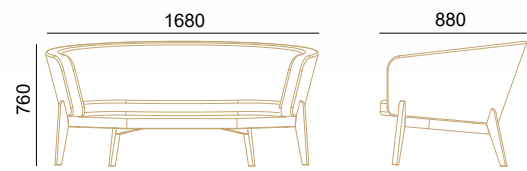

SMOOTH

Designer *Tobias Jacobsen*



SMOOTH – a true craft, where the quality shown is as crucial as the design. “I wanted to create a light and easy look by lifting the upholstery with a wooden frame, which in return creates a shadow around the sofa. Furthermore, I wanted the frame to bring the upholstery to focus. The contrast between the frame and the cushioning gives the sofa a smooth look accompanied with extended horizontal lines, which altogether is a nice addition to Your room.”

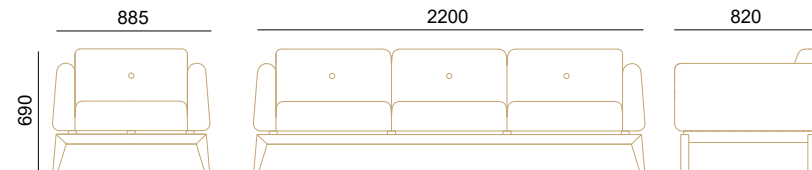

CONCORD



CONCORD – Pure and simple silhouettes in pursuit of elemental comfort and elegance.



SIGMA



SIGMA the soft seating system designed to create personalized waiting and informal meeting areas within open plan spaces. Made with innovative materials that give shape to products comfortable, durable and with a contemporary design.

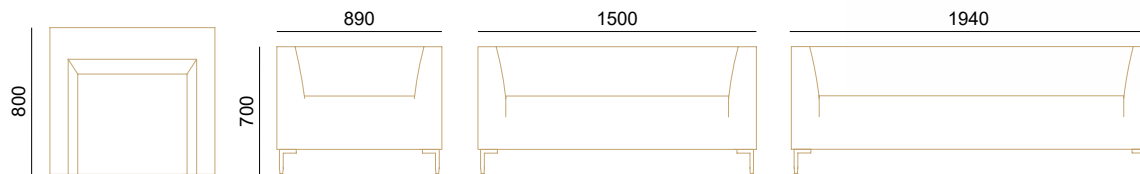

RAAHE

Designer *Carlos Guijarro*

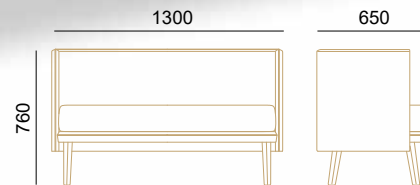

Designed to be located mainly in kitchens and waiting rooms, the ergonomics of the sofa is similar to dining chair, but allowing the user to sit in a more relaxed way.

PLENTY

Designer *Kasper Meldgaard*

PLENTY sofa is both elegant and classic. It works as a modern reinterpretation of the traditional roll armsofa and offers great comfort with its good back support and soft rearrangeable scatterback cushions. The timeless profile, the nordic feel of the oild oak legs and the great comfort goes perfectly hand in hand.

The back and the armrests merges seamlessly for an elegant look and futhermore creates comfortable cozy coners. The back pillows are large scattebacks that are comfortable and can be rearranged to add a personal touch to the sofa. The curved armrests and back provides great comfort.

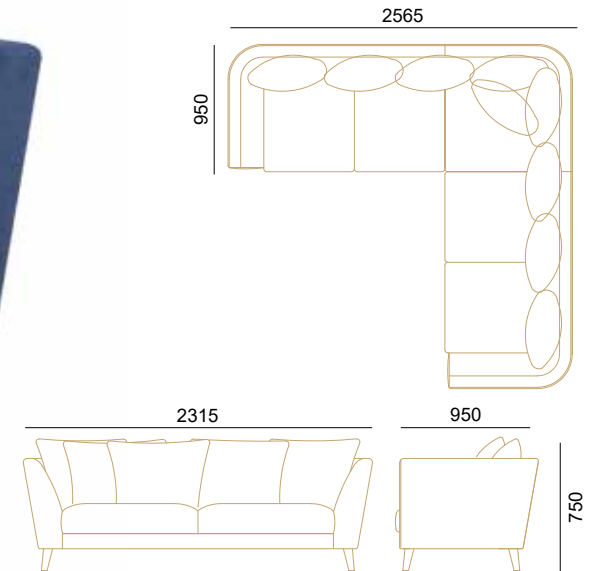

KIDES

Designer *Carlos Guijarro*

KIDES sofa range was created to bring a fresh and Nordic style into living rooms. Available in two versions, double seat and modular coner, this model present an elegant and cozy combination of materials by having a solid base with fluffy seat and backrest. The detailed stitching together with a curated selection of fabrics and colours create an elegant model that will allow users to enjoy and relax with full comfort.

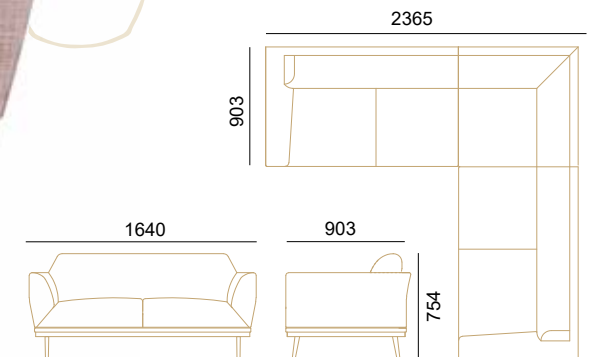

BOSS

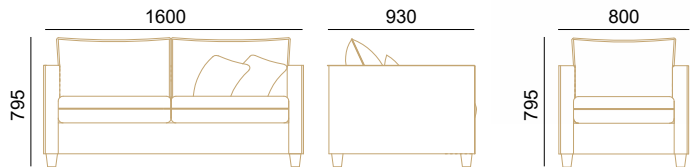

BOSS – radiates spacious coziness and yet has an understated feel due to its well-balanced proportions. Its pleasantly soft upholstery provides extraordinary comfort: the user sinks into its sea of cushions with not a hard surface to be felt.



COGNAC

COGNAC – Modern and elegant lines for this sofa range, 1 / 2 / 3-seater sofa. The Cognac collection balances formal lines with casual seating proportions. The result is a classic sofa that compliments any contemporary space.

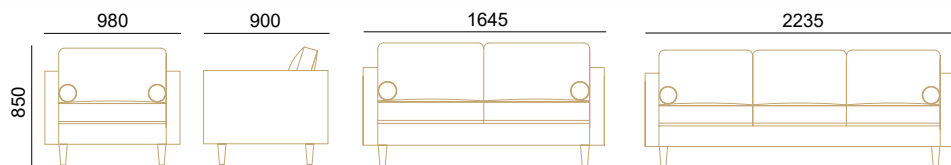

LENNA

Go for creativity, all the way. Step by step, create the combination of your dreams and have a new take on the traditional sofa with **LENNA**.

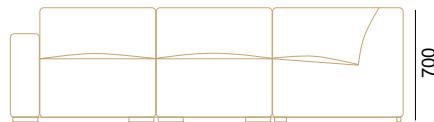
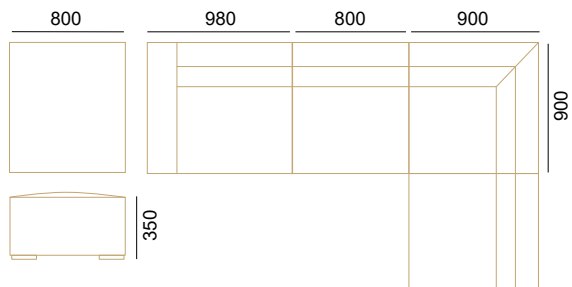
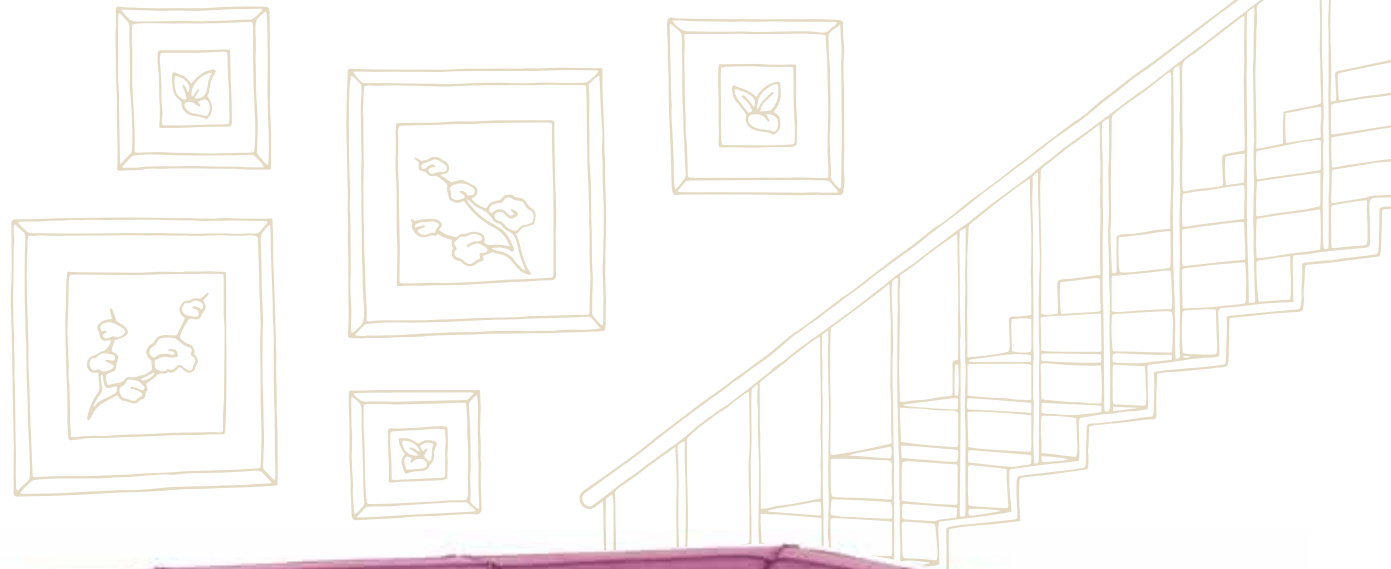

JESSE

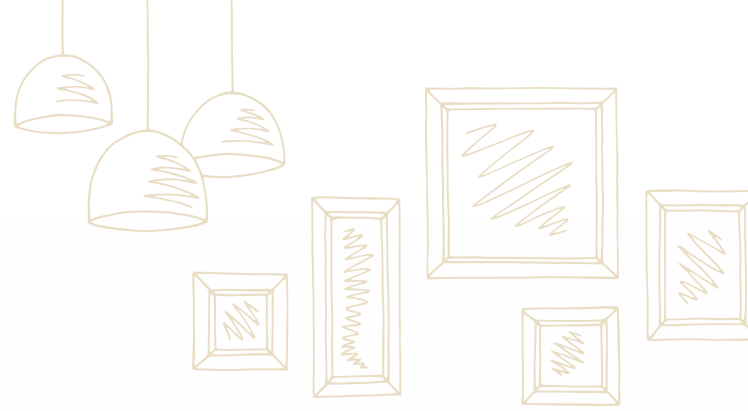

JESSE – intriguing design idea, seats without cushions, distinctive lines and versatile solutions, for comfort that indulges your inspiration of the moment.



COMFORTO

COMFORTO – Innovating interior living space design through a seating system displaying into a variety of elements, with different features, a strong aesthetic identity, elegant proportions and unrivaled comfort.

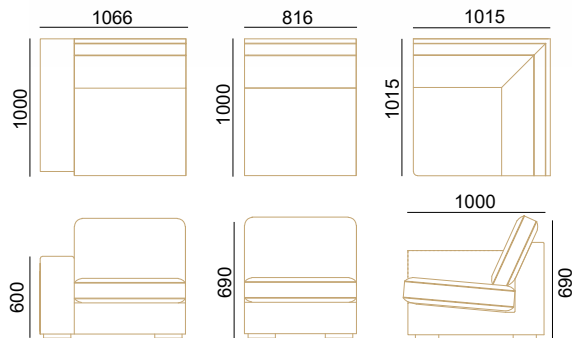

FREDENSBORG

FREDENSBORG – The one and several sofas: this is the guiding principle of Fredensborg, thanking the different elements, it offers the widest possibilities within the same space: linear, angular composition, chaise longue, terminal composition, understanding your wishes and, with you, can be placed in a different room.

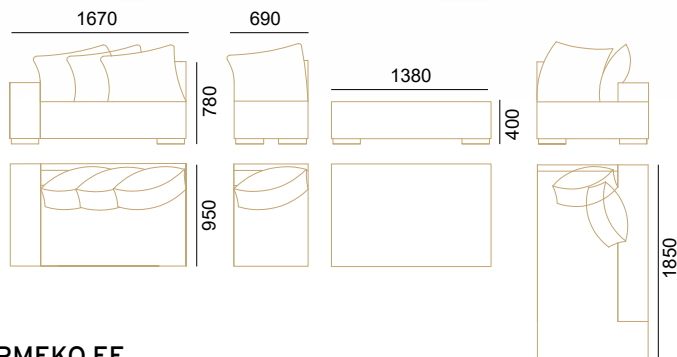

FLORIDA

FLORIDA – The sofa is the piece of furniture that best conveys feelings of comfort and warmth and around which the most important moments of everyday life revolve.

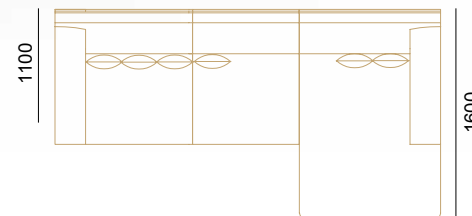
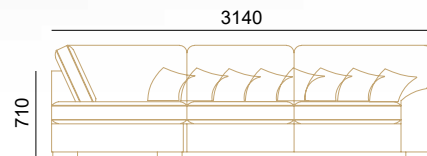

ANNA

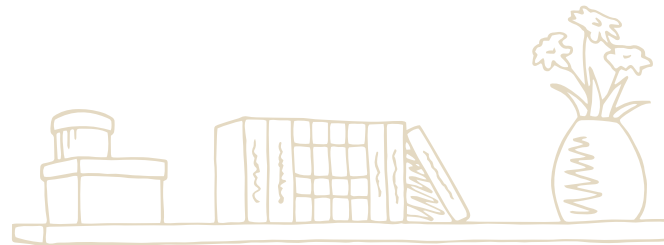

The **ANNA** sofa avoids indifference and routine! It creates communication between people, a physical, lively and spontaneous communication.

The solitary ones will appreciate lying down, with their feet up.

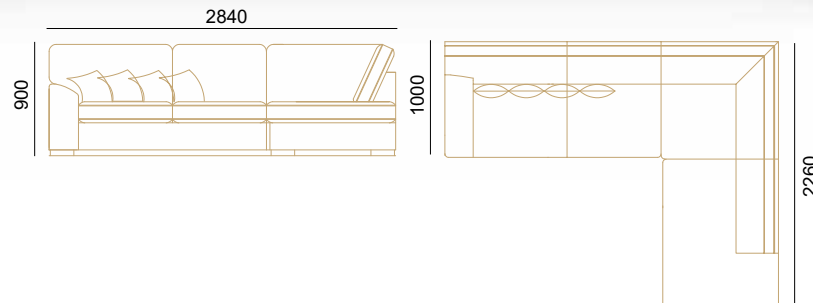

DARIO

DARIO – The large sofa is comfortable and with its high backrest what supports your head. Due to the closed pillows, the couch always has the correct appearance.

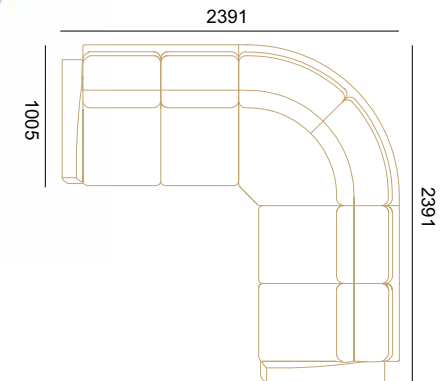
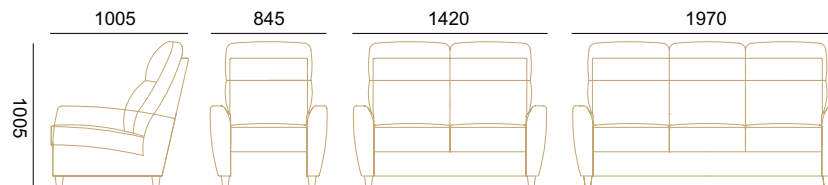

SHABBY

SHABBY – Create a cozy coner in Your livingroom with this contemporary style conersofa. You will have a very soft and comfortable experience.

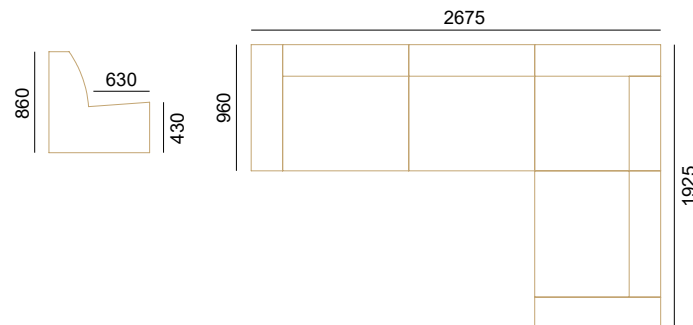
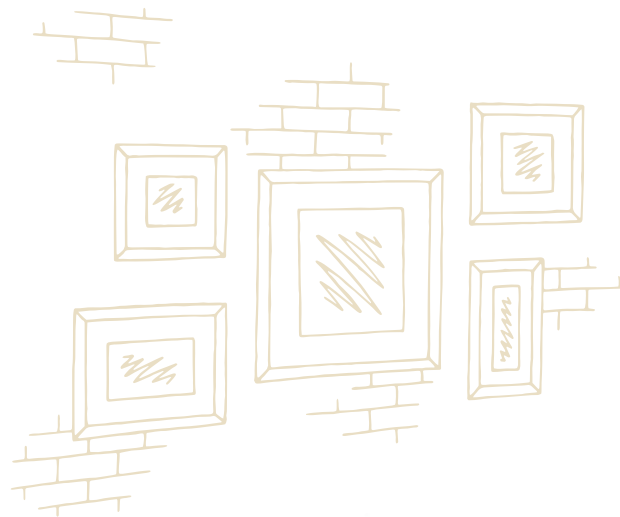

PARMA



PARMA – This sofa features pure, minimalist elegance enriched by unmistakable vintage details.

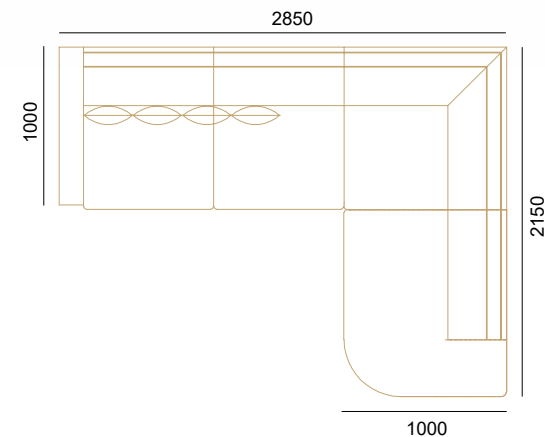
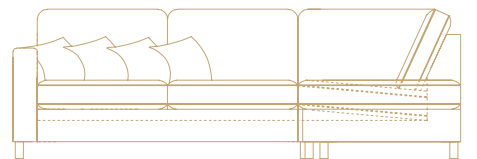

THEO

THEO – Comfortable sofa, wide and elegant but essential and formal as well.

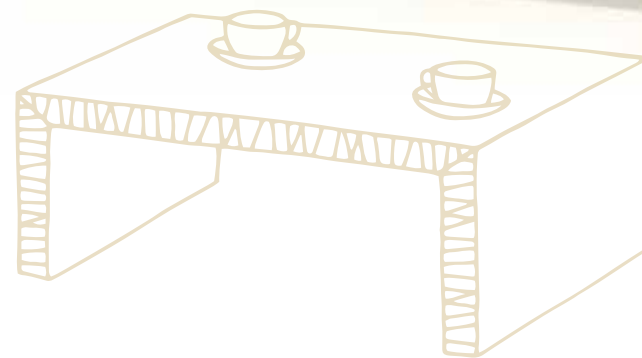
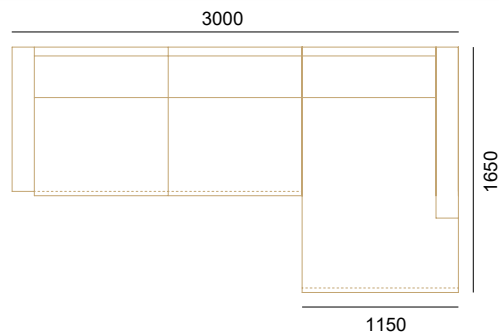

DJURSHOLM

Balanced proportions combined with soft contours and generous padding make the **DJURSHOLM** set warm and inviting. Features ensure superior performance in terms of comfort, durability and breathability. Elegant piping outlines the cushions and armrests. **Elegant piping outlines the cushions and armrests.**

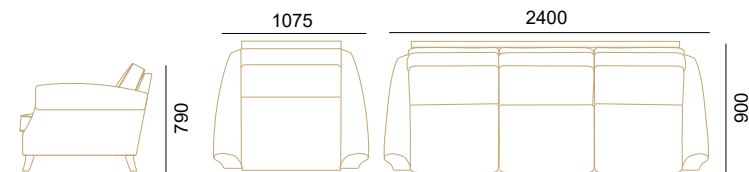

FJELLNESS

FJELLNESS – This beautiful sofa is striking for its simplicity. You will have a comfortable coach. It consists of a wooden frame.

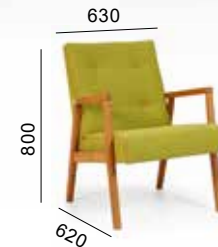
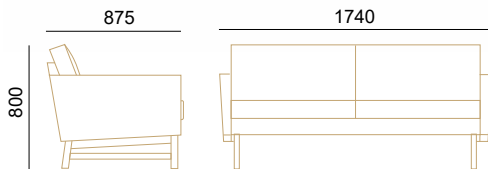

RETRO – It is an idea of lasting beauty, renewed in surprising and magical ways, a Design that bears witness to its own time while announcing the lifestyle of the future.

RETRO

HOWARD MINI

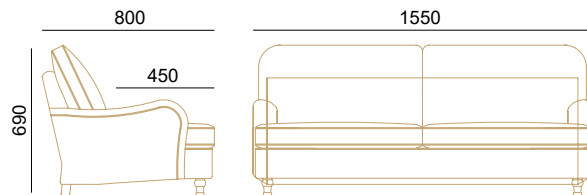

HOWARD MINI – Classical sofa for the children, to help them learn about taste and style right from the start. All the safety and peace of mind to help your little one grow up in a quality environment.



ALMA ARMCHAIR

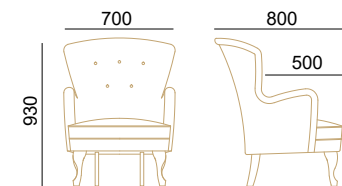

ALMA – has a strong character. Self-confident, expressive and unique, but still never officious. A piece of jewellery for every ambience, regardless if private apartment, hotel or public institution.

VILMA ARMCHAIR

VILMA – If you want to create a romantic style in any room, choose our Vilma, suits a modern environment as well as traditional cosy interiors.

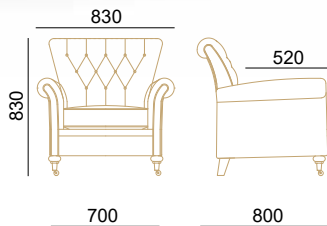

ELLIPS STOOL

"Art with an attitude"



ELLIPS – An essential component for any modern home that embraces conviviality. Any of our poufs lets you re-arrange the conversation area and the sleeping area without affecting pre-established arrangements

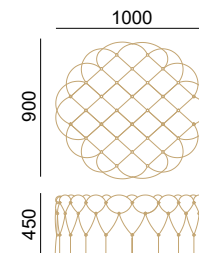

CARL



CARL – dining chair, which makes up any refined ambience. Specifically created to be placed around a dining table or a coffee table.

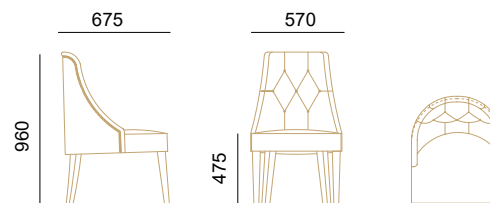

CHESTERFIELD

CHESTERFIELD – Carl Fredrik brand was established in 1998. Products reflect our passion for quality furniture that respects tradition and care for the environment. To share this passion, Carl Fredrik products come fully hand-made and include only premium materials that selected with a view to minimizing the ecological footprint of our manufacturing process. Carl Fredrik carries under the name the furniture items addressed to people who like luxurious lifestyle surrounded with warmth, extreme comfort and high quality design.

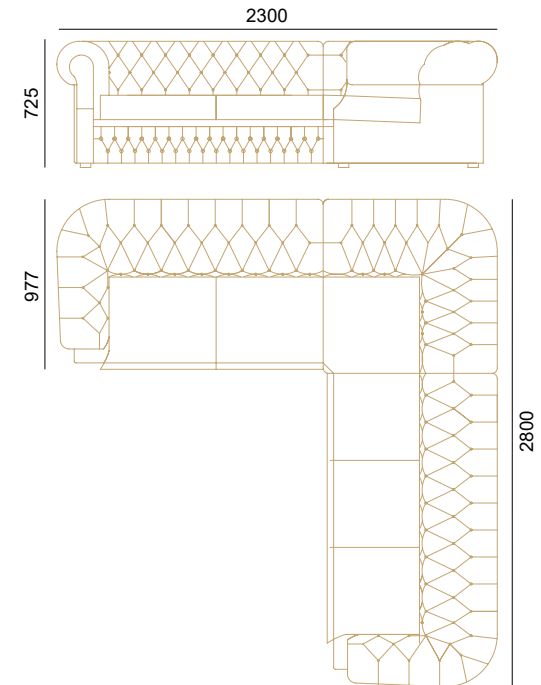
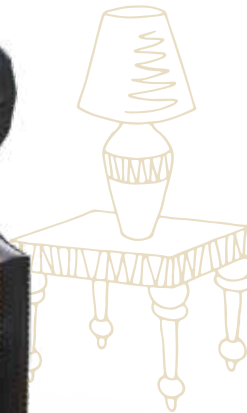



"It's not possible to avoid saying that a Chesterfield set is a true symbol of luxury."

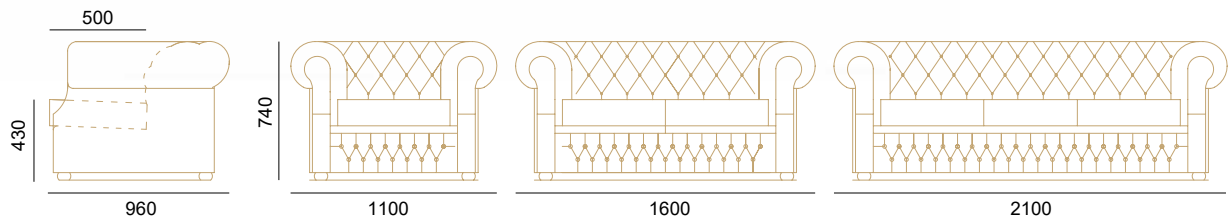

YORK

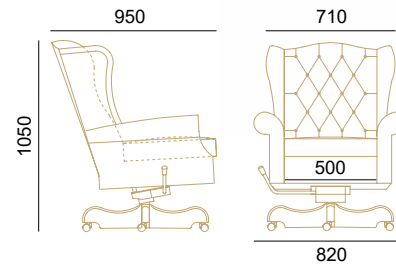
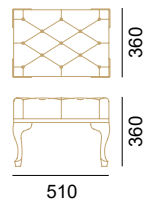
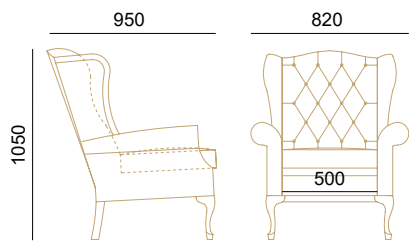

WINSTON





FACTORY ADDRESS

Soojuse tee 18 • Lohkva
Tartumaa 62207 • Estonia

TARMEKO GROUP WEBSITE

www.tarmeko.ee

