



TARMEKO
NORDIC



TARMEKO, once a woodworking cartel, is now an innovative FSC® (C116426) certified furniture producer in Estonia. The company has been working together with Scandinavian and Estonian designers. The created products are collected under the trade mark Tarmeko Nordic®.

The brand carries the new contemporary expression with a touch of classical style elements so that the furniture would fit every home, office or public space. The collection includes timelessly elegant chairs and tables together with other accessories to make the surrounding interior more comfortable and luxurious.

Since Tarmeko values the environment and innovative thinking, the company uses high quality raw and finishing materials from responsible sources, the best fashionable fabrics or leathers and technical solutions in design that are practical and sustainable.



N037



N037 is a chair designed by *Carsten Buhl*. The elegant yet modern chair is an excellent addition to the lounge area and office waiting or meeting room.

Frame: birch or oak top veneer

Cover: natural leather or fabric





Ray / RayBoy / Tuular



RAY, RAYBOY AND TUULAR - products that have been designed by *Elmet Treier*. The pale oak top veneer and elegant metal legs create a traditional feeling but with a truly contemporary edge.

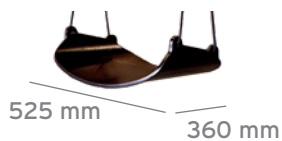

A modern interior scene featuring a hanging lamp and two chairs against a distressed wall. The wall is made of light-colored plaster with significant peeling and cracking, revealing a darker surface underneath. A hanging lamp with a dark, curved shade is suspended by two thin black cords. In the foreground, two chairs with dark metal frames and light brown seats are positioned on a wooden plank floor. The chair on the left is a standard chair, while the one on the right is a taller stool. The overall aesthetic is industrial and minimalist.

Tuular

Ray

RayBoy



TP2



TP2 chair is designed by *Henrik Schulz*. It is a modern chair in Scandinavian design and it is suitable for homes, offices and other public spaces.

Frame: birch or oak top veneer



Zürich



Cover: sheepskin, natural leather,
fabric or bonded leather
Frame: birch with beech or oak top veneer





Goal

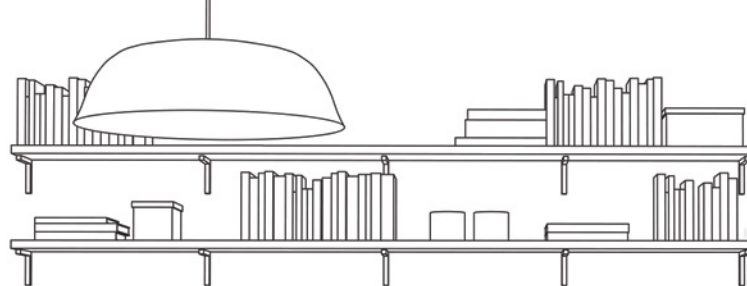

1080
mm



570 mm

680 mm

390
mm



430 mm

520 mm

Cover: sheepskin, natural leather,
fabric or bonded leather
Frame: birch or beech top veneer

Spider 



Cover: sheepskin,
natural leather, fabric
or bonded leather
Frame: birch plywood





Tango

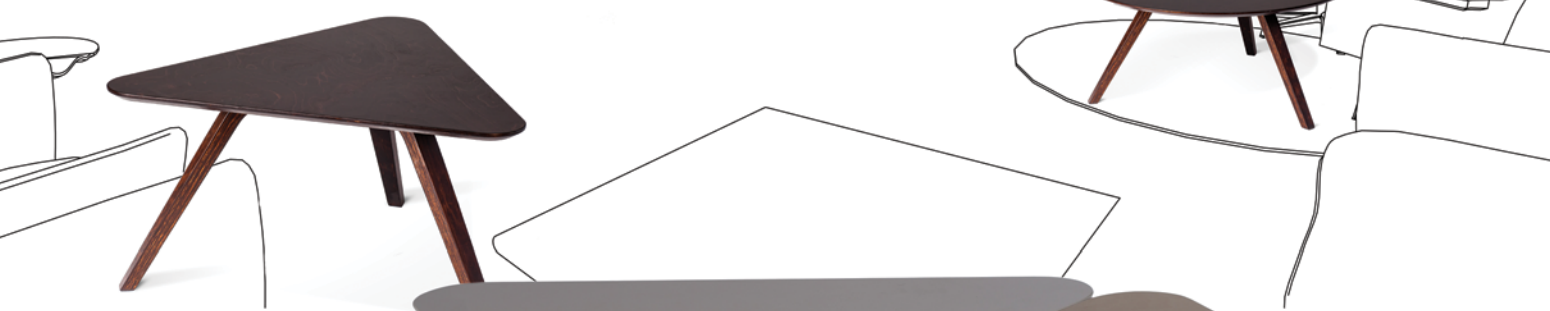
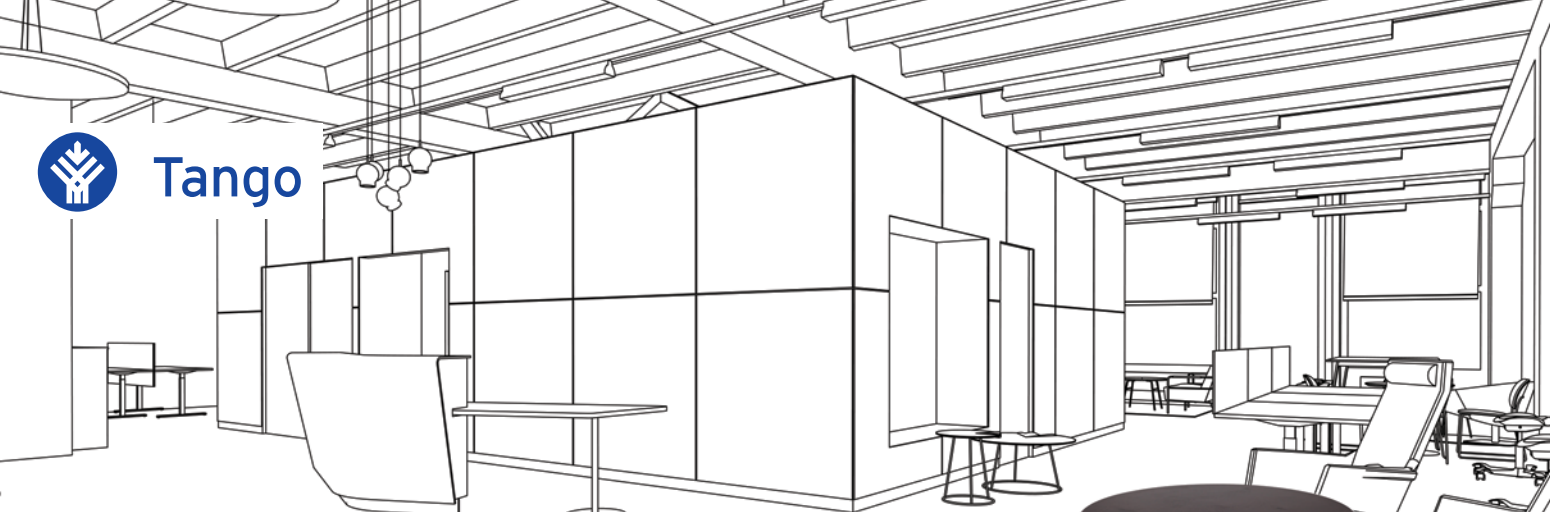

800 mm

417 mm



800 mm

417 mm



table Bend / stool Lux

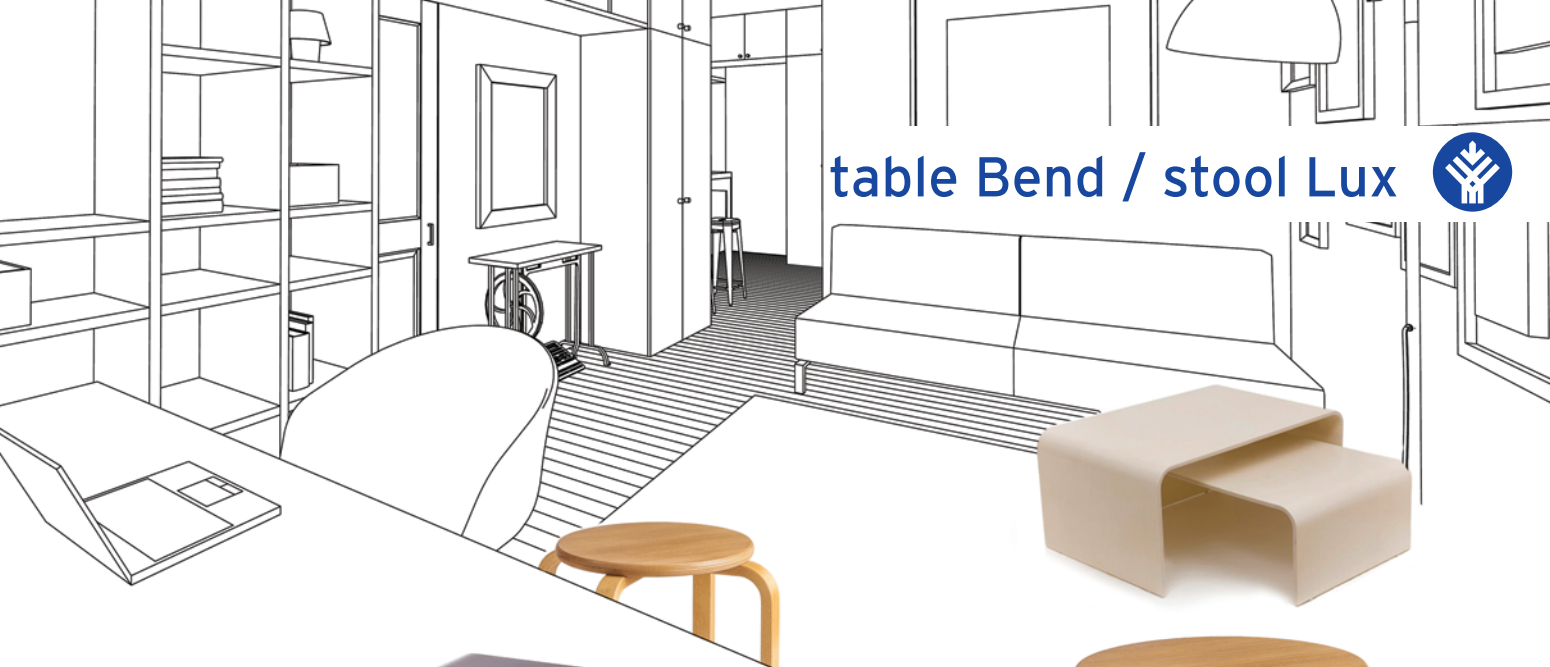

LUX is a classical stool with oak top veneer seat and oak stain legs, making it more luxurious comparing to the classical stool made out of birch.

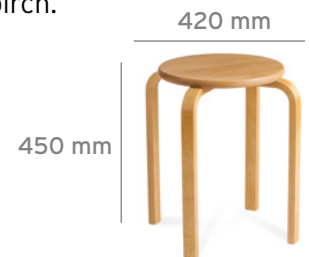
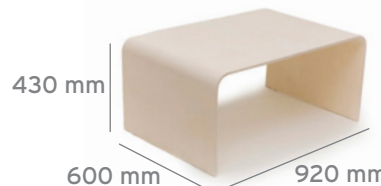
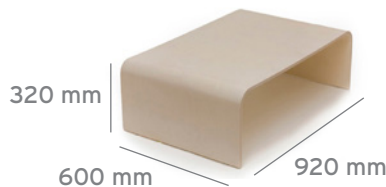
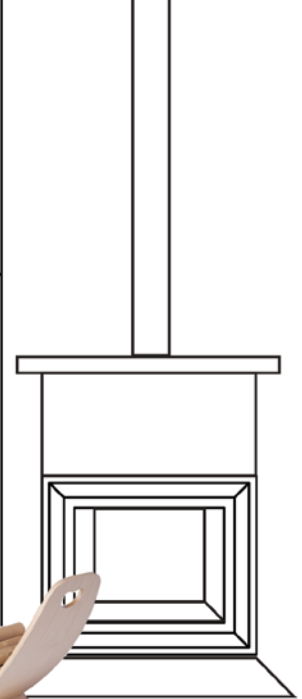
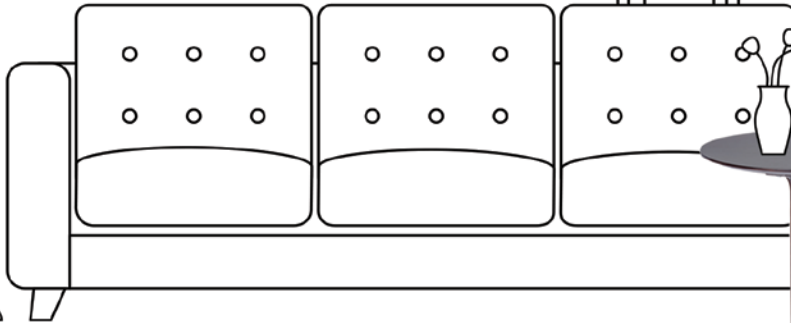
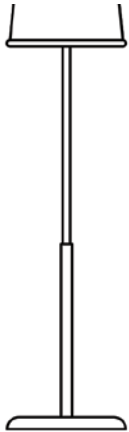
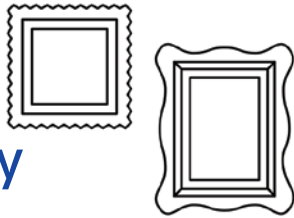



table Jaanus wood rack Lily



500 mm

545 mm



500 mm

440 mm



290 mm

LILY can be used as a wood rack but also for storing magazines or newspapers.

Milonga set



Wooden parts: birch or oak top veneer
Chair cover: natural leather or fabric





Karjala set





TARMEKO LPD OÜ

Soojuse tee 14
Lohkva, Luunja vald
Tartumaa 62207
Estonia

sales@tarmeko.ee
+372 744 6705

www.tarmeko.ee