

TCLMaster

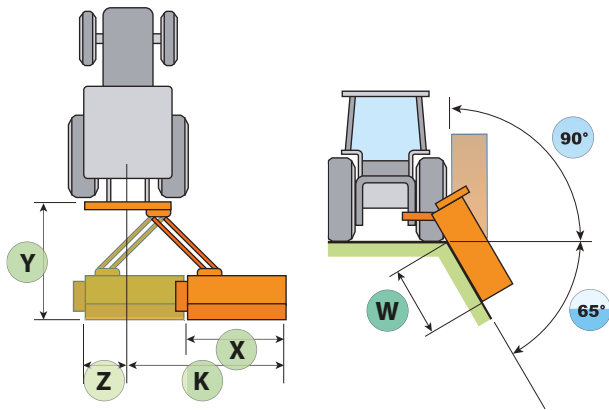





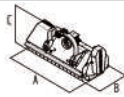
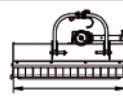

HARDOX®
WEAR PLATE

HARDOX registered by SSAB www.ssab.com



DIMENSIONI	DIMENSION				
MODELLO MODEL MODELL MODELO	X	Y	Z	K	W
200	1938	2300	542	3225	2087
230	2340	2300	542	3532	2387
250	2495	2300	542	3687	2587

CARATTERISTICHE TECNICHE - TECHNICAL DATA - CARACTERISTIQUES TECHNIQUES - TECHNISCHE DATEN - CARACTERÍSTICAS TÉCNICAS								
MODELLO MODEL MODELL MODELO								
	A - B - C	mm - inch	rpm	CV - KW	N°	Kg - lb	N°	N°
200	2460 - 1880 - 1100	1938 - 76	540	100 - 75	4	1170 - 2580	44	22
230	2800 - 1880 - 1100	2245 - 88	540	120 - 90	4	1221 - 2690	52	26
250	2950 - 1880 - 1100	2400 - 94	540	150 - 110	5	1246 - 2747	52	26

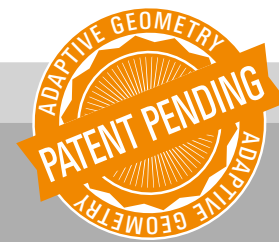

1

- Rotore ad alta resistenza.
- Rotor de alta resistencia.
- Hochresistent Rotorwelle.
- High resistance rotor.
- Rotor à haute résistance.
- Высокочпрочный ротор

2

- Mazza doppio tagliente brevetto TIERRE
- Martillo de doble corte - patente TIERRE
- Hammerschlegel mit doppelt Schnitt-TIERRE Patent
- Double cutting hammer - TIERRE patent
- Marteau à double tranchant - brevet TIERRE
- Двойной режущий молот - патент TIERRE



- Attacco al trattore Cat.3
- Trasmissione a bagno d'olio con ruota libera
- Slitte di appoggio regolabili in altezza
- Piedini di appoggio
- Cinghie dentate
- Cuscinetti rotore a doppia sfera oscillante
- Rotore Bilanciato elettronicamente
- Diametro rotore 194mm
- Rullo di appoggio con raschia rullo regolabile in altezza
- Diametro rullo 194mm
- Giunto cardanico
- Protezione Carter
- Snodo per auto livellamento al terreno
- Velocità di taglio 52m/sec



- Tractor linkage Cat.3
- Oil sealed transmission with free wheel
- Supporting slides height adjustable
- Rest
- Toothed belts
- Rotor bearings with double oscillating sphere
- Electronically balanced rotor
- Rotor diameter 194mm
- Supporting roller with adjustable in height scraper
- Roller diameter 194mm
- P.T.O. shaft
- Protecting carter
- Junction for self levelling on the ground
- Cutting speed 52 m/sec



- Attelage tracteur Cat.3
- Transmission bain d'huile avec roue libre
- Patins d'appui réglables en hauteur
- Pieds d'appui
- Courroies dentées
- Roulements rotor à double sphère oscillante
- Rotor équilibré électroniquement
- Diamètre rotor 194mm
- Rouleau d'appui avec décrotoir réglable en hauteur
- Diamètre rouleau 194mm
- Cardan
- Protection carter
- Jonction pour auto nivellement au terrain
- Vitesse de coupe 52m/sec



- Traktor Anhängung Kat.3
- Ölbad-Getriebe mit Freilauf
- Verstellbare Stützkufe
- Stützfüsse
- Gezackte Treibriemen
- Rotor Lager mit doppel-schwankenden Kugeln
- Rotor elektronisch balanciert
- Rotor Durchmesser 194mm
- Verstellbare Stützwalze selbstreinigend mit Erdkratzer
- Walze Durchmesser 194mm
- Gelenkwelle
- Schütz
- Kupplung zum Boden Selbst-Nivellierung
- Vorschubgeschwindigkeit 52m/sec



- Conexión Cat. 3
- Transmisión con rueda libre
- Patines de apoyo ajustables
- Apoyos
- Correas dentadas
- Rodamientos oscilantes de bolas doble (rotor)
- Rotor balanceado electronicamente
- Diámetro rotor 194mm
- Rodillo de apoyo con raspador ajustable
- Diámetro rodillo 194mm
- Junto cardán
- Protección carter
- Unión autonivelante al suelo
- Velocidad de corte 52m/sec



- Крепление к трактору цеп.3
- Трансмиссия с обгонной муфтой
- Регулируемые по высоте опорные салазки
- Опорные ножки
- Клиновые зубчатые ремни
- Ротор закреплен на сферических двухрядных роликоподшипниках
- Электронно-сбалансированный ротор
- Диаметр ротора 194mm
- Опорный самоочищающийся регулируемый по высоте ролик
- Диаметр ролика 194mm
- Карданное соединение
- Шарнирное соединение для автоматической регуляции высоты
- Скорость резки 52m/sec