

# Vehicle Safety & Warning

## Product Catalogue

[www.vehiclesafetyandwarning.co.uk](http://www.vehiclesafetyandwarning.co.uk)  
[sales@vehiclesafetyandwarning.co.uk](mailto:sales@vehiclesafetyandwarning.co.uk)  
+44 (0) 1134575540

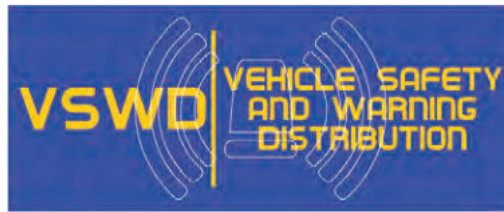

The VSWD catalogue focuses on our fast moving, popular items.

We have access to over 100,000 part numbers so if you don't see what you need in the catalogue, please get in touch for assistance.

## CONTACT US

Vehicle Safety and Warning Distribution Ltd  
Unit 12 Follifoot Ridge Business Park  
Pannal Road  
Harrogate  
HG3 1DP

Telephone: +44 (0) 113 4575540

Email: [sales@vehiclesafetyandwarning.co.uk](mailto:sales@vehiclesafetyandwarning.co.uk)

Skype: [vehiclesafetyandwarning.co.uk](https://www.skype.com/people/vehiclesafetyandwarning.co.uk)

You can follow us on Social Media:



[@vehiclesafetyandwarning](https://www.facebook.com/vehiclesafetyandwarning)



[@VSWDVehicleSafe](https://twitter.com/VSWDVehicleSafe)



[@vehicle-safety-and-warning-distribution-ltd-9b3a17111](https://www.linkedin.com/company/vehicle-safety-and-warning-distribution-ltd-9b3a17111)



[@VSWDVehicleSafe](https://www.instagram.com/VSWDVehicleSafe)

## Slim & Compact Beacons



### VSWD-231L Series Beacons



Dimensions:  
Bolt & Mag  
46mm x 112mm  
Flexi Din  
140mm x 112mm

Dual Voltage  
ECE R65 approved in Amber & Blue  
ECE R10  
18 LEDs  
Polycarbonate Lens  
IP67  
2 Year Warranty  
4 Flash Patterns

Colours available:



All colours 1W LEDs

Bolt, Magnet, Flexi Din



## Tall Heavy Duty Beacons



### VSWD-240 Series Beacons

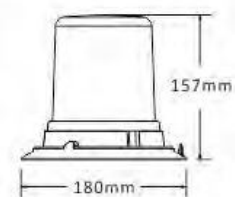
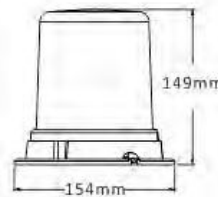
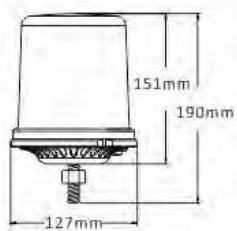

Dual Voltage  
ECE R65 approved in Amber, Blue Inc Dual Colour  
ECE R10  
128 SMD LEDs - 256 SMD LEDs in Dual Colour  
Polycarbonate Lens  
IP67  
3 Year Warranty  
9 Flash Patterns - 11 for Dual Colour

Colours available:



Dual Colour Available

Bolt, Magnet, Flexi Din

## Square Beacons



### VSWD-229 Series Beacons



### VSWD-230 Series Beacons



Dual Voltage  
ECE R65 approved in Amber, Blue Inc Dual Colour  
ECE R10  
64 SMD LEDs - (128 SMD LEDs in Dual Colour)  
Polycarbonate Lens  
IP67  
3 Year Warranty  
9 Flash Patterns - 11 for Dual Colour

Colours available:



Dual Colour Available

4 Bolt or Magnet

## 209 Series Beacons



### VSWD-209 LED Series Beacons



### VSWD-209 SMD Series Beacons

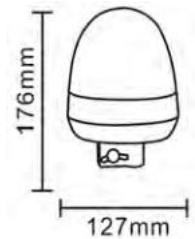
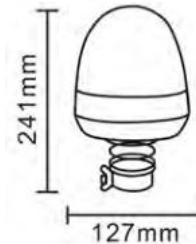
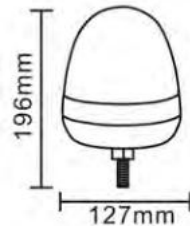
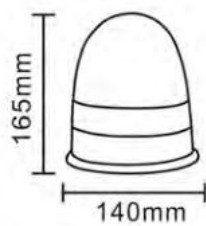
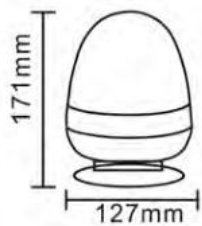

- Dual Voltage
- ECE R65 approved in Amber (LED Option)
- ECE R10
- 16 \* 3W LEDs or 60 SMD LEDs
- Polycarbonate Lens
- IP66
- 2 Year Warranty
- 3 Flash Patterns

Colours available:



Bolt, Magnet, Flexi Din, Din



## 200 Series Beacons



### VSWD-200 LED Series Beacons



### VSWD-200 SMD Series Beacons

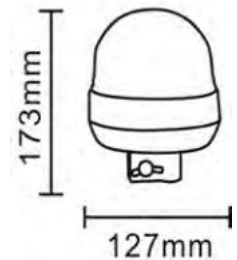
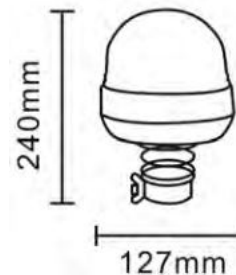
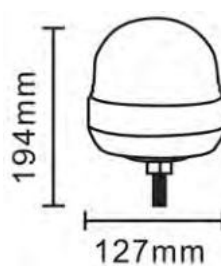
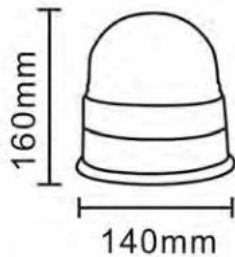
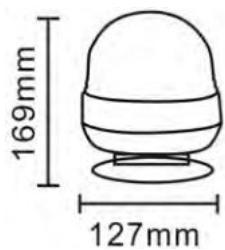

- Dual Voltage
- ECE R65 approved in Amber (LED Option)
- ECE R10
- 16 \* 3W LEDs or 60 SMD LEDs
- Polycarbonate Lens
- IP66
- 2 Year Warranty
- 3 Flash Patterns

Colours available:



Bolt, Magnet, Flexi Din, Din

## Beacons



### VSWD-210B



60 SMD  
3 Flash Patterns

### VSWD-283



30 SMD  
1 Flash Pattern

### VSWD-218B



60 SMD  
3 Flash Patterns

### VSWD-217B



80 SMD  
3 Flash Patterns

Dual Voltage  
ECE R10  
Polycarbonate Lens  
IP66  
2 Year Warranty  
Bolt or Magnet installation

Colours available:





# BEACONS

## Beacons

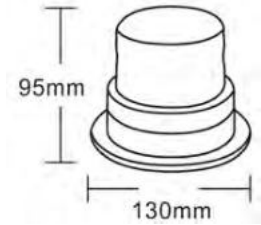

- VSWD-278A - R65 Approved - 40 SMD LED - 9-30v - 3 Flash Patterns
- VSWD-278B - R10 Approved - 12 SMD LED - 9-30v - 1 Flash Pattern
- VSWD-278C - R10 Approved - 32 SMD LED - 9-30v - 3 Flash Patterns

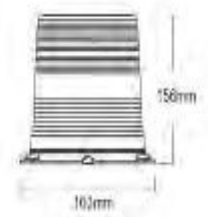
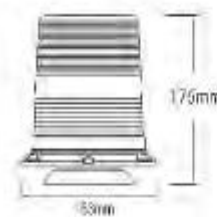
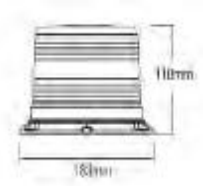

- VSWD-234 - R10/SAE Class 1 Approved - 48 SMD LED - 9-48v
- VSWD-235 - R10/SAE Class 1 Approved - 48 SMD LED - 9-48v
- 7 Flash Patterns
- Aluminum Base

- Polycarbonate Lens
- IP66
- 2 Year Warranty
- Bolt or Magnet installation

Colours available:



## Beacons



VSWD-255



Coming Soon - Airport Compliant Version

VSWD-255-AP

ECE R10  
CAP168 Compliant  
10-110v  
Single Flash Pattern

Polycarbonate Lens  
ECE R10/R65/SAE Approved  
IP67  
10-30v  
24 LEDs  
6 Flash Patterns  
2 Year Warranty  
1 Bolt, 3 Bolt, Flexi Din, Magnetic Fixings

Colours available:



## Fork Lift Truck Safety



### VSWD-FLT278

20 SMD LED  
1 Flash Pattern

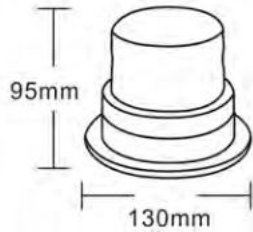

### VSWD-FLT280

30 SMD LED  
1 Flash Pattern

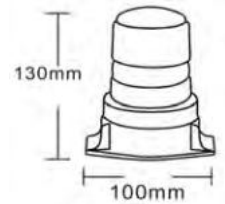

### VSWD-FLT232S

18 SMD LED  
1 Flash Pattern

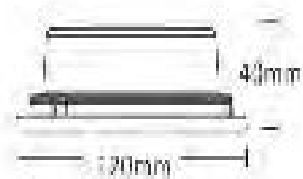

Colours available:



10-110v  
ECE R10  
Magnet or Bolt Installations  
2 Year Warranty



## Fork Lift Truck Safety



VSWD-FLT241

20 SMD LEDs  
1 Flash Pattern



10-110v  
ECE R10  
Bolt Installations  
2 Year Warranty

Colours available:



## Fork Lift Truck Safety



VSWD-FLT620 Arrow Safety Lamp

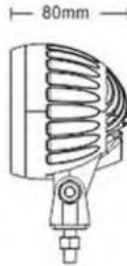
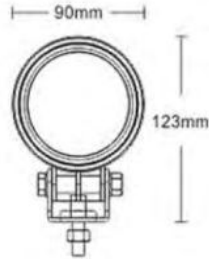

Arrow available in Red or Blue  
3 LEDs



VSWD-FLT621 Red Line Safety Lamp



Available in Red or Blue  
2 LEDs

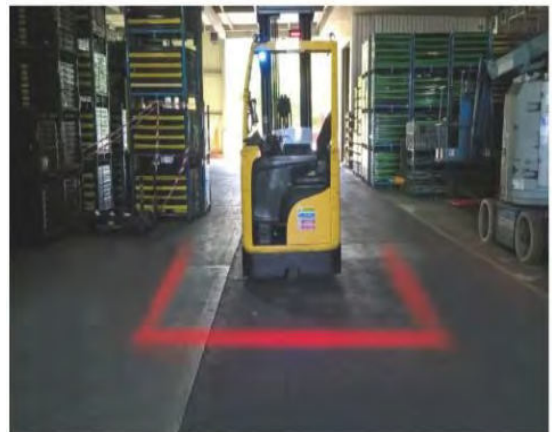
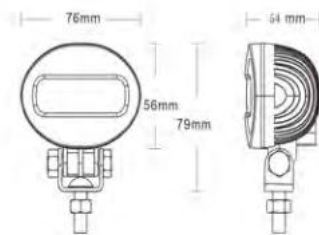

Colours available:



- 10-80v
- ECE R10
- Stainless Steel Bracket
- 2 Year Warranty
- 3W LEDs

## Marker Lights



CE  RoHS



ECE R3  
ECE R91

12-24v  
IP67  
2 LEDs

Surface or Bracket Mount

VSWD-849

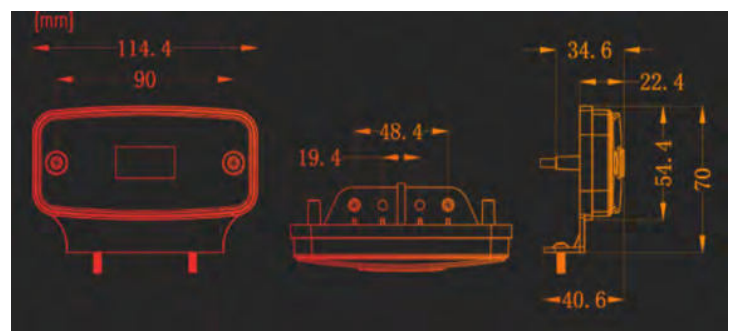

Colours available:





## Bullet Marker Lights



VSWD-802

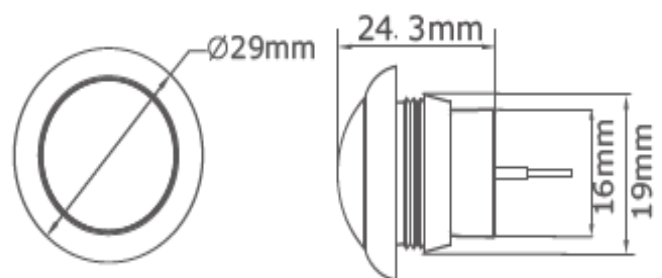

ECE R10 Approved

12v or 24v

Flush Mount with Grommet

IP67

Colours available:



## Tail Lamp



VSWD-850

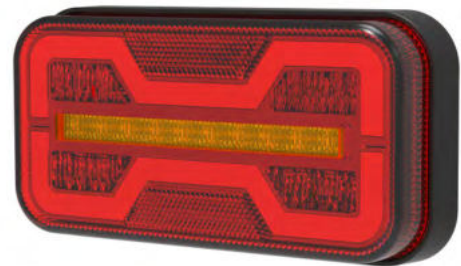

ECE R3  
ECE R6  
ECE R7  
ECE R23  
ECE R38

ECE R10 Approved  
10-30v  
IP67  
Stop, Tail, Turn, Reverse, Fog

Colours available:



## Interior Light



VSWD-INT310-DV - Dual Voltage  
300mm in length - 18 LEDs

VSWD-INT510-DV - Dual Voltage  
500mm in length - 30 LEDs

VSWD-INT1000 - Dual Voltage  
1000mm in length - 60 LEDs

Silicon Lens  
Aluminium Housing  
2 Year Warranty  
Colour Temperature 6000k

Colours available:





# INTERIOR LIGHT

## Interior Light



VSWD-INT173 - 22 LED - 173mm

VSWD-INT300 - 54 LED - 300mm

VSWD-INT600 - 130LED - 600mm

Wires, Touch Switch or PIR versions available

10-30v

ECE R10

Aluminium Housing

Polycarbonate Cover

2 Year Warranty

Colours available:



## Round Interior Light



VSWD-INT130 - 85 LED - 130mm

VSWD-INT130-03 - 85 LED - 130mm With PIR

10-30v  
ECE R10  
Aluminium Housing  
Polycarbonate Cover  
2 Year Warranty

Colours available:



# INTERIOR LIGHT

## Interior Light with Radar PIR



VSWD-STL310-PIR-12v  
300mm in length - 24 LEDs

VSWD-STL510-PIR-12v  
500mm in length - 30 LEDs

VSWD-STL1000-PIR-12v  
1000mm in length - 60 LEDs

Colours available:



Silicon Lens  
IP65  
Aluminium Housing  
2 Year Warranty  
Colour Temperature 6000k



# LIGHT BARS

## 740 Series Light Bars



Available in various lengths  
and colours



Dual Voltage  
ECE R65 approved in Amber & Blue  
ECE R10 & SAE Approved  
Polycarbonate Lens  
IP67  
2 Year Warranty  
18 Flash Patterns

Colours available:



1W LEDs

Mounting Brackets inc.

# LIGHT BARS

## 740 Series Blue Light Bars

Made to order only



Dual Voltage  
Polycarbonate Lens  
IP67  
2 Year Warranty  
18 Flash Patterns

1W LEDs

Mounting Brackets inc.

- All clear with blue LED ECE R10 and ECE R65
- All Blue ECE R10
- All clear lens with blue top ECE R10 and ECE R65
- All clear with black top ECE R10 and ECE R65
- All blue with Black top ECE R10

VSWD-741-B 577mm ECE R65 ECE R10 SAE Blue LED  
VSWD-742-B 877mm ECE R65 ECE R10 SAE Blue LED  
VSWD-743-B 1197mm ECE R65 ECE R10 SAE Blue LED

Colours available:



With Take down and Alley Lights

VSWD-742-B-TDA 877mm ECE R65 ECE R10 SAE Blue LED TD/Alleys  
VSWD-743-B-TDA 1197mm ECE R65 ECE R10 SAE Blue LED TD / Alleys

And with Speaker (110w 11 Ohms)

VSWD-742-B-TDA-SPK 877mm ECE R65 ECE R10 SAE Blue LED TD/Alleys/ Speaker  
VSWD-743-B-TDA-SPK 1197mm ECE R65 ECE R10 SAE Blue LED TD / Alleys/ Speaker

# MINI LED LIGHTBARS

## Compact Mini Bars



VSWD-110 30LEDs  
\*\*26 Flash Patterns

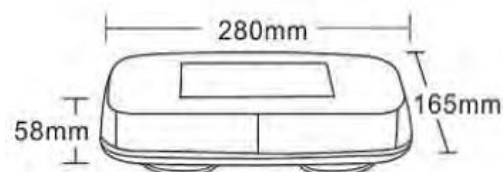

VSWD-111 72 SMD



VSWD-112 72 SMD

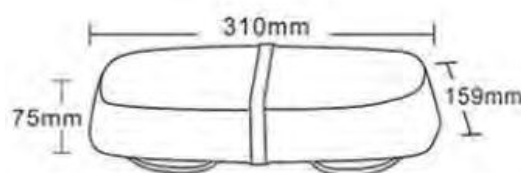

Colours available:



Dual Colour available

All colours 3W LEDs  
SMD options 0.5W per LED

Bolt & Magnet Fixings

- Dual Voltage
- ECE R65 approved in Amber
- ECE R10
- Polycarbonate Lens
- IP65
- 2 Year Warranty
- 8 Flash Patterns including synchronisation



# MINI LED LIGHTBARS

## Compact Mini Bars



VSWD-155 56 LEDs

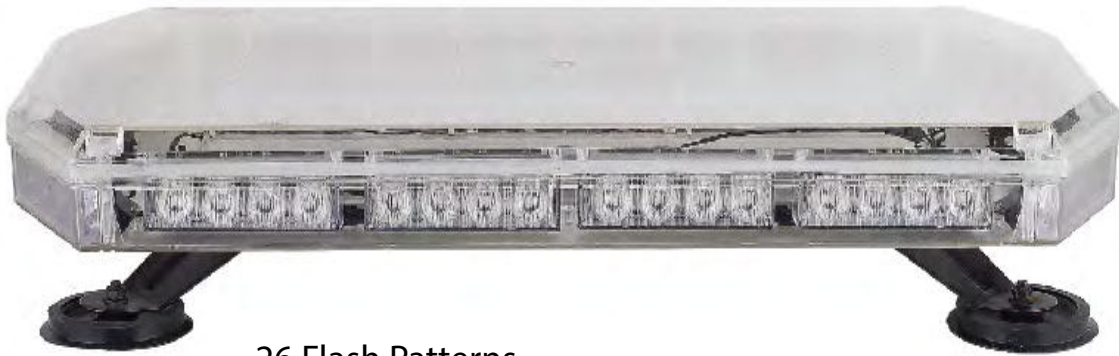

26 Flash Patterns

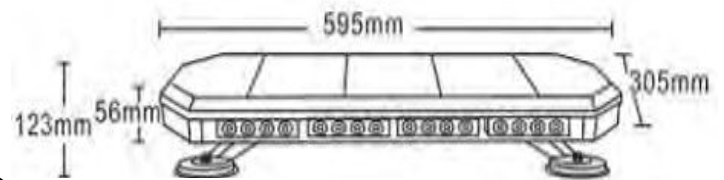

VSWD-130AA 24LEDs



3 Flash Patterns

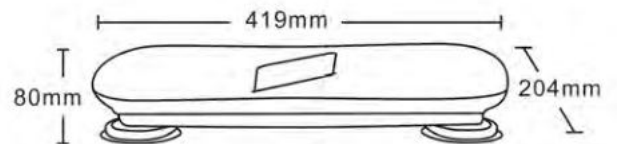

Colours available:



Dual Colour available

All colours 3W LEDs

Bolt Magnet Fixings

- Dual Voltage
- ECE R65 approved in Amber
- ECE R10
- Polycarbonate Lens
- IP65
- 2 Year Warranty

# MINI LED LIGHTBARS

## XDC Mini Bar

VSWD-190



Ultra slim and compact mini bar.  
32 LEDs for single colour  
64 LEDs for dual colour  
Bracket included for bolt model

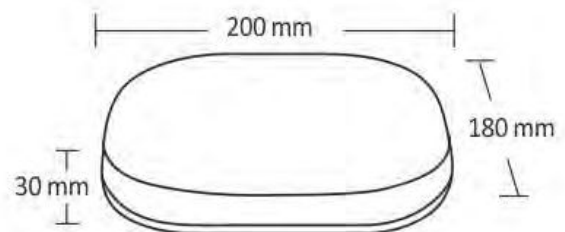

Dual Voltage  
ECE R65 approved \*  
ECE R10  
Polycarbonate Lens  
IP67  
3 Year Warranty  
26 Flash Patterns  
Bolt or Magnet Fixing

Colours available:



Dual Colour available

All colours 3W LEDs

\* R65 in Blue (colour lens)  
\*R65 in Amber (clear lens)  
\*R65 in Amber/Blue (clear lens)

# MINI LED LIGHTBARS

## Compact Mini Bars



VSWD-191

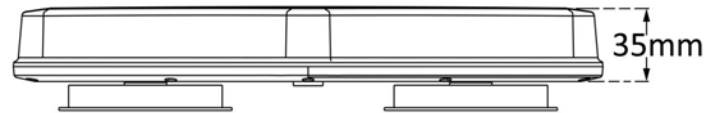
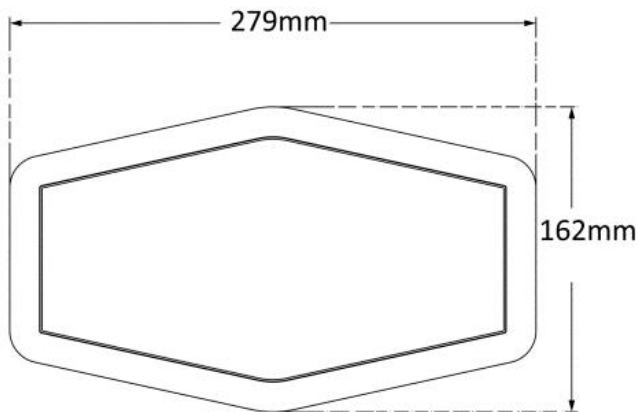

R65 in Amber, Blue & Amber/Blue

- Dual Voltage
- ECE R65 approved
- ECE R10 & SAE approved
- Polycarbonate Lens
- IP66
- 2 Year Warranty
- 26 Flash Patterns including synchronisation

Colours available:



Dual Colour available

Bolt & Magnet Fixings



# STROBES & FLASHERS

## Standard LED Heads

(R10  
Only)



VSWD-3HLED



VSWD-4HLED



VSWD-6HLED

Dual Voltage  
ECE R65 approved in Amber and Blue  
ECE R10  
Polycarbonate Lens  
IP67  
2 Year Warranty  
14 Flash Patterns including synchronisation



## 3, 4 or 6 LED Option

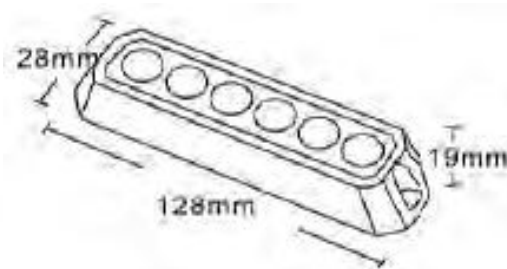
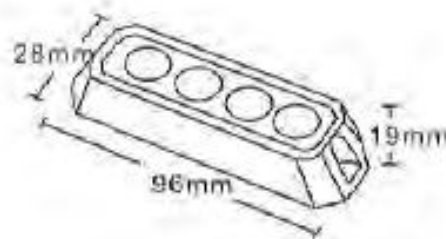

Colours available:



Amber & Blue 3W LEDs  
Red, White & Green 3W LEDs

# STROBES & FLASHERS

## Ultima Lite Range Slim Range



VSWD-6H73

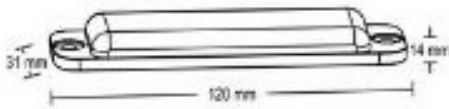

VSWD-12H73-2



Dual Colour 'S' Slim Range  
Twice the LED's, separate control

VSWD-12H73S



VSWD-24H73S-2



Dual Voltage  
ECE R65 approved in Amber and Blue  
ECE R10  
Polycarbonate Lens  
IP67  
3 Year Warranty  
26 Flash Patterns including synchronisation

Colours available:



Amber & Blue 5W LEDs  
Red, White & Green 3W LEDs

Dual Colour available

# STROBES & FLASHERS

## 707 Series Slim Range



3, 4 or 6 LED Option

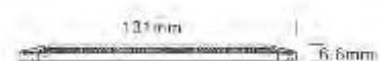

VSWD-3H707

VSWD-4H707

VSWD-6H707

- Dual Voltage
- ECE R65 approved in Amber and Blue
- ECE R10
- Polycarbonate Lens
- IP67
- 3 Year Warranty
- 26 Flash Patterns including synchronisation

Colours available:



Amber & Blue 5W LEDs  
Red, White & Green 3W LEDs

Dual Colour available

# STROBES & FLASHERS

## 708 Series LED Heads



3, 4 or 6 LED Option

VSWD-3H708



VSWD-4H708

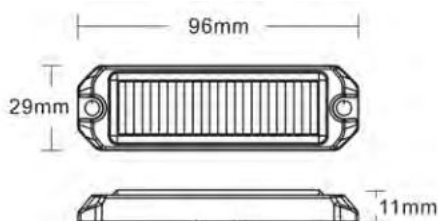

VSWD-6H708

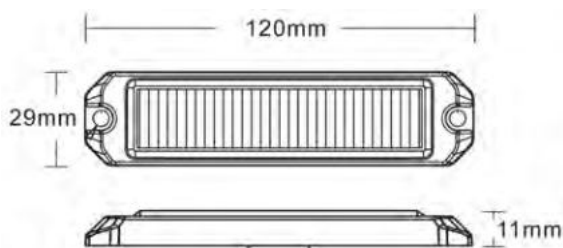

Colours available:



All colours 5W LEDs

- Dual Voltage
- ECE R65 approved in Amber and Blue
- ECE R10
- Polycarbonate Lens
- IP67
- 3 Year Warranty
- 26 Flash Patterns including synchronisation



# STROBES & FLASHERS

## Corner LEDs



VSWD-C704



**180°** light spread

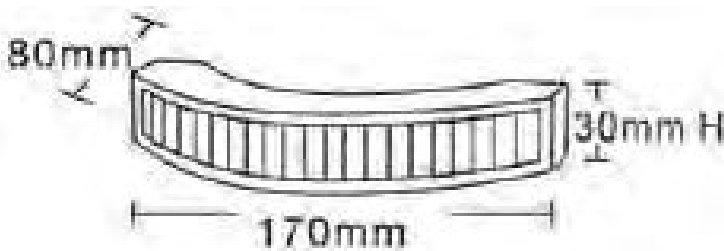

Colours available:



- Dual Voltage
- ECE R65 approved in Amber and Blue
- ECE R10
- Polycarbonate Lens
- IP67
- 2 Year Warranty
- 12 Flash Patterns including synchronisation

Amber & Blue 1W LEDs  
Red, White & Green 1W LEDs

## Hideaway LEDs



VSWD-HL301

2 LEDs



VSWD-HL305

8 LEDs



Dual Voltage  
ECE R10  
5W LEDs  
Polycarbonate Lens  
IP67  
3 Year Warranty  
23 Flash Patterns including synchronisation

Colours available:



Dual Colour available

# STROBES & FLASHERS

## Hi-Lite LED



VSWD-HIL308



VSWD-HIL309

Colours available:



Dual Colour available

Blue & Amber 5W LEDs

Red, White & Green 3W LEDs

- Dual Voltage
- ECE R65 approved in Amber and Blue
- ECE R10
- Polycarbonate Lens
- IP67
- 3 Year Warranty
- 23 Flash Patterns including synchronisation

## Traffic Director

### VSWD-TD31



#### Stocked variants

- VSWD-TD31-196-A - 196mm with cig plug
- VSWD-TD31-340-A - 340mm with cig plug
- VSWD-TD31-628-A - 628mm with cig plug
- VSWD-TD31-1204-A - 1204mm with wires

- VSWD-TD31-CUP - Bracket with suction cup
- VSWD-TD31-CLIP - Bracket for double row
- VSWD-TD31-2CONN - Double Row connector

On special request;

- Can be made in additional lengths
- Can be made dual colour
- Can be made as a single or double row
- Can be supplied with a controller instead of wires on TD31-1204A model



#### Dual Voltage

ECE R10/R65/SAE Class 1 Approved

Polycarbonate Lens

3 Year Warranty

27 Flash Patterns

Colours available:





## Dash Lights



New ECE R65 Approved Dash Light

Dual Colour available



ECE R65 approved in Amber & Blue  
ECE R65 approved in dual colour Amber/Blue

6 LEDs @ 5W for Amber & Blue  
12 LEDs @ 5W in dual colour Amber/Blue  
6 LEDs @ 3W in all other colours

26 Flash patterns (21 for dual colour)

Dual Voltage  
ECE R10 Approved  
Polycarbonate Lens  
2 Year Warranty  
Velcro Strip with 3M adhesive for fixing

Colours available:



## Wireless Trailer Kit



These R65 lamps come in a carry case with a USB cable and cigarette plug for charging.



Battery Operated 5V  
ECE R10 / R65 Approved  
12 LEDs  
Double Flash Pattern  
Magnetic Mount  
IP67  
Polycarbonate Lens  
2 Year Warranty

Colours available:



## Work Lamps



VSWD-WL601

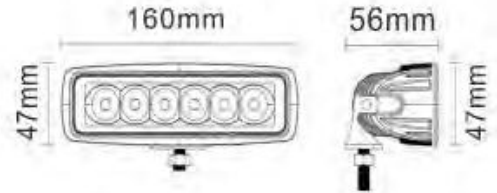

18W - 6\*3W LEDs 1260LM  
Spot Beam

VSWD-WL604

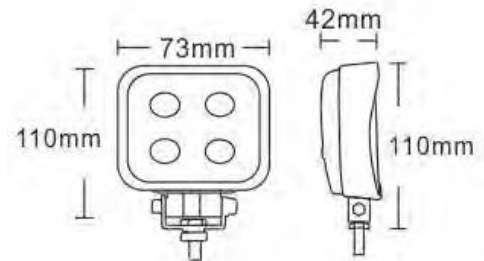

12W - 4\*3W LEDs 1080LM  
Spot Beam

Colours available:



10-80v  
ECE R10  
Die Cast Aluminium Housing  
Stainless Steel Bracket  
2 Year Warranty

## Work Lamps



VSWD-WL602

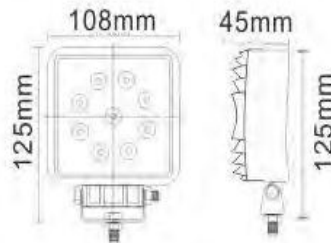

27W - 9\*3W LEDs 1400LM  
Flood Beam



VSWD-WL603

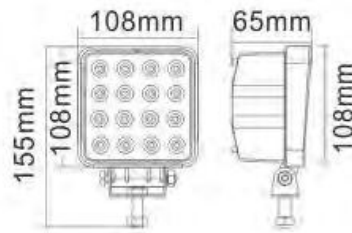

48W - 16\*3W LEDs 2400LM  
Flood Beam



VSWD-WL605

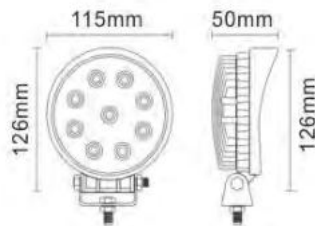

27W - 9\*3W LEDs 1400LM  
Flood Beam

10-80v  
ECE R10  
Die Cast Aluminium Housing  
Stainless Steel Bracket  
2 Year Warranty

Colours available:





## Work Lamps



VSWD-WL606

27W - 9\*3W LEDs 1400LM  
Flood Beam  
10-80v



VSWD-WL623

### SOS Utility Lamp

9 \* 3W LEDs in White  
9 \* 3W LEDs in Amber

3 Modes:  
100% Intensity White  
50% Intensity White  
SOS Flash mode in Amber or White

Rechargeable Battery

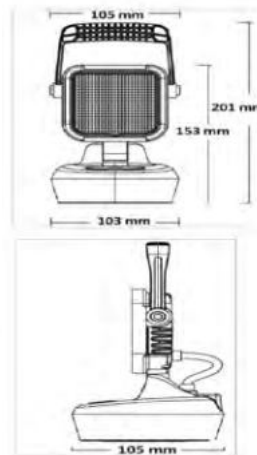

Colours available:



ECE R10  
Die Cast Aluminium Housing  
Stainless Steel Bracket  
Handle  
Magnetic Base

## Work Lamps



VSWD-WL626

Utility Lamp

9 x 1W LEDs

4 Modes

100% Intensity

50% Intensity

SOS Flash

Quad Flash

Rechargeable Battery

DC 5V

9 x 1w LEDs

IP65 Rated

Strong Magnetic Base

Handle, USB Socket, Reverse Charge Function

Battery UN38.3 certified

Supplied with mains and 12v charger

Colours available:



## Work Lamps



VSWD-WL610-F-AMP

R23 Approved



12W - 4\*3W LEDs 487LM  
Flood Beam - Manoeuvring Lamp  
IP67  
AMP Connector fitted



Dimensions:  
72mm x 64mm x 37mm

VSWD-WL611



30W - 6\*5W LEDs 2500LM  
Flood Beam  
IP68

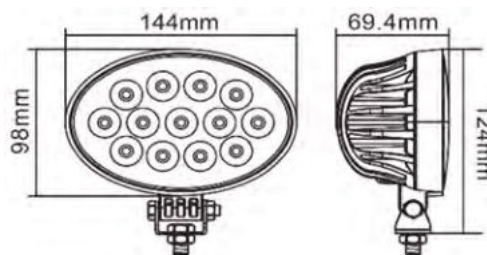

Colours available:



10-30v  
ECE R10  
Die Cast Aluminium Housing  
Stainless Steel Bracket  
IP67

# WORK LAMPS

## Work Lamps



**VSWD-WL630-CP**  
25W - 3000LM  
Combo Beam  
With Position light

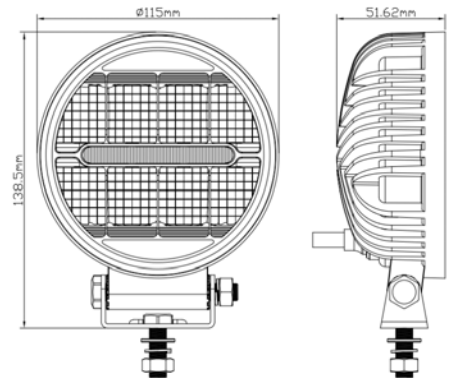

**VSWD-WL632-F**  
15W - 1800LM  
Flood Beam

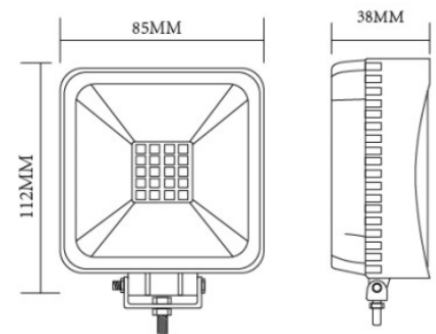

**VSWD-WL634-C**  
48W - 3500LM  
Combo Beam

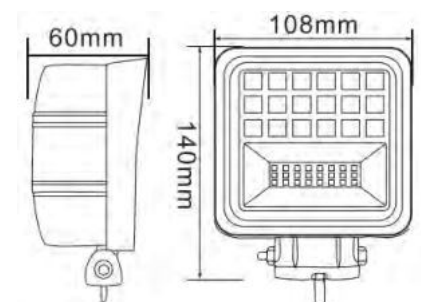

Colours available:



10-30v  
ECE R10  
Die Cast Aluminium Housing  
Stainless Steel Bracket  
IP67



## Work Lamps



VSWD-WL631

**2-Way installation**

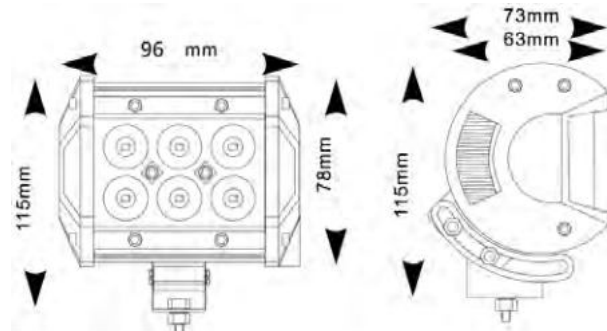

12 + 9 LEDs  
18W - 2200LM  
Combi Beam

Micro Light - VSWD-ML01



3 LEDs \* 3W  
9W - 648LM  
30cm Cable

Dimensions:  
78.9mm x 46.9mm

10-30v  
ECE R10  
Die Cast Aluminium Housing  
Stainless Steel Bracket  
IP67

Colours available:



## Reverse Alarm



### 402 Alarm

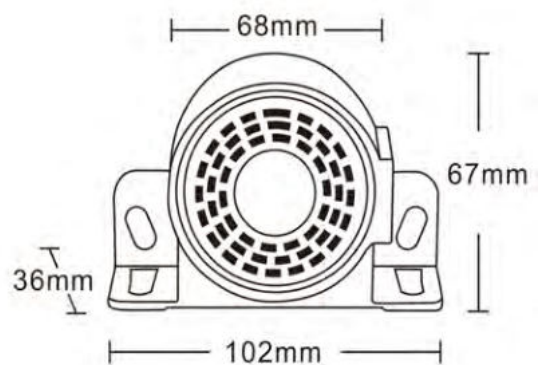
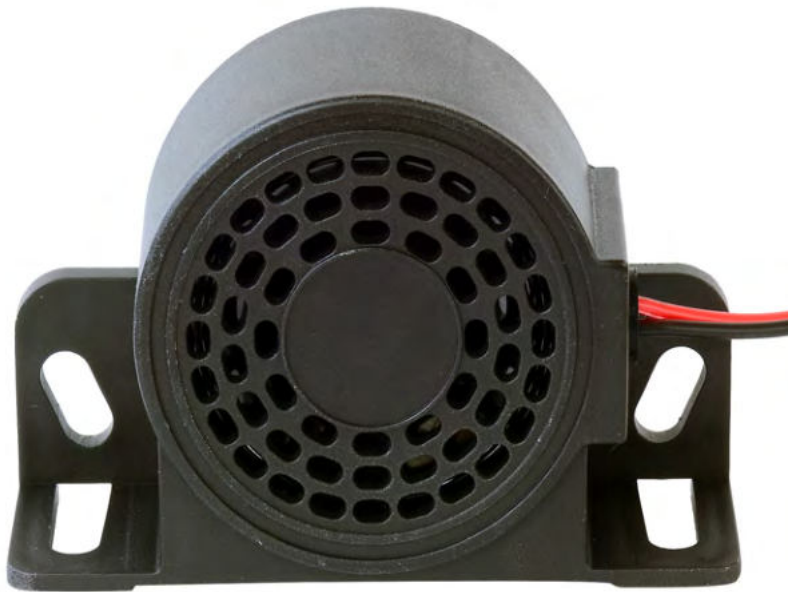

12v-80v

IP67

dB Ratings 92, 97, 102, 107

Tonal or Alternative Sound

Wires or Studs

## Brackets



Bracket 3  
Beacon mount

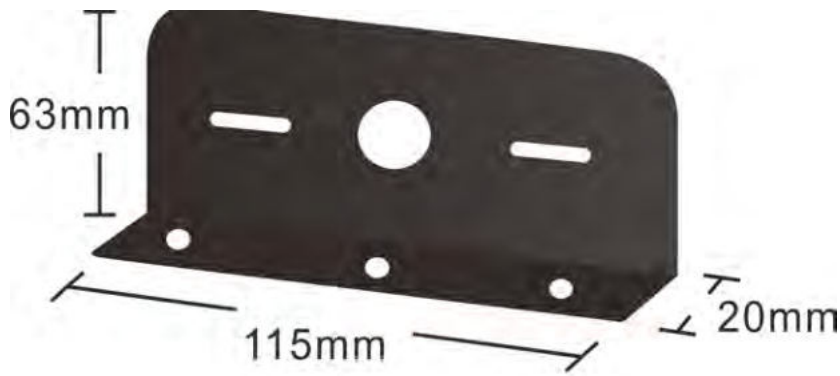

Bracket 7  
Strobe mount

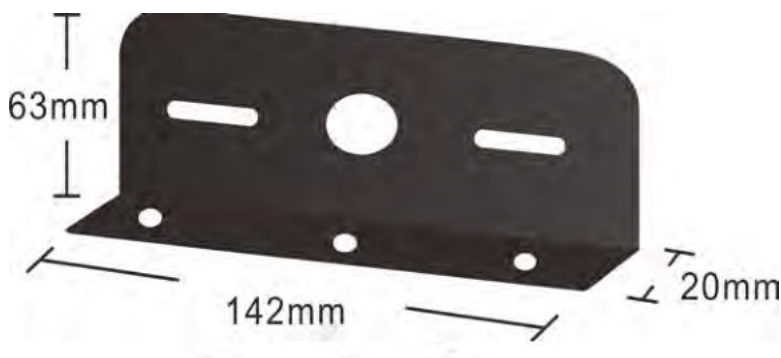

Bracket 8  
Strobe Mount

Colours available:





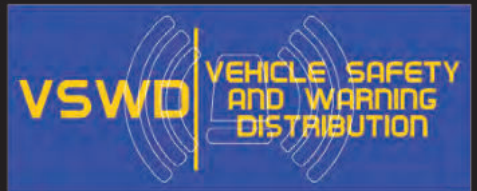

[www.vehiclesafetyandwarning.co.uk](http://www.vehiclesafetyandwarning.co.uk)  
[sales@vehiclesafetyandwarning.co.uk](mailto:sales@vehiclesafetyandwarning.co.uk)  
+44 (0) 1134575540