

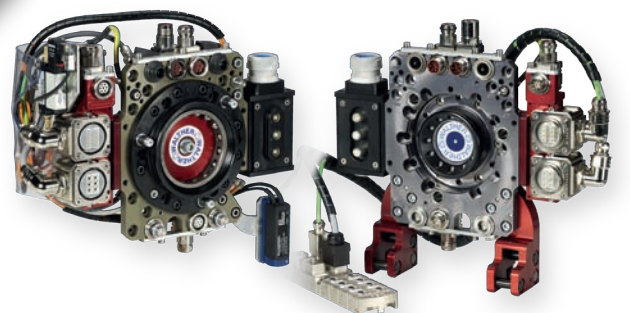

walther  
präzision

WalCoDo®

WALTHER CONNECTING & DOCKING



**Technical Catalogue**



## Industries and Applications

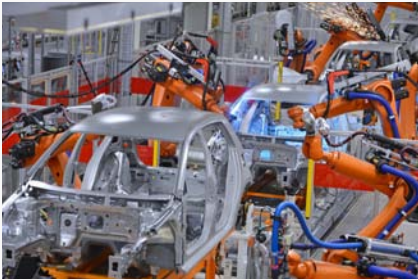

### The right quick coupling system for each application.

Pneumatics, oil or water hydraulics, gases and other - even aggressive fluids. Alongside a variety of mono-couplings, in multi-couplings / docking systems and tool changers for industrial robots, electric and optical signals as well as power current are safely transmitted and separated.





## Advantages and Benefits

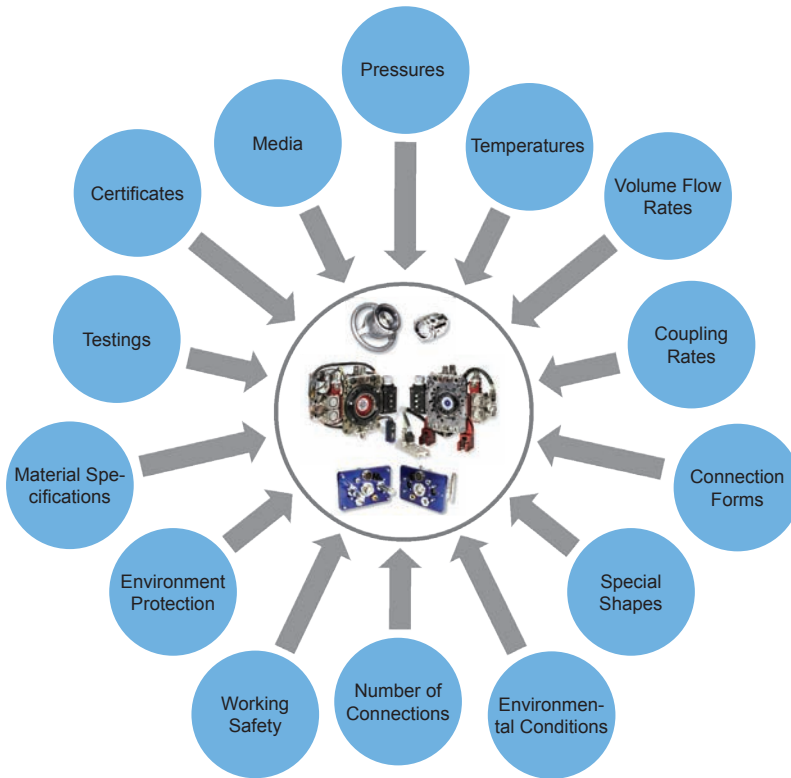

### ● Your advantages

You work with a partner with decades of experience with mono- and multicoupling-based applications.

Our 400,000 variants are available in the world's largest standard program, usually available from stock!

Our quick coupling systems fulfill comprehensive quality and authorisation requirements, individually adaptable to your application.

You benefit from a company structure with the fundamental principles of a traditional family-run business: quality, reliability and durability.

All "Made in GERMANY".

### ● Your benefits

WALTHER-PRÄZISION supplies your fluidic and gaseous media interface.

WALTHER-PRÄZISION designs and builds in accompaniment with your project in 2D / 3D.

WALTHER-PRÄZISION supports validation procedures.

WALTHER-PRÄZISION manufactures and delivers at firmly defined prices - including documentation.





## Cv value determination: approximate values

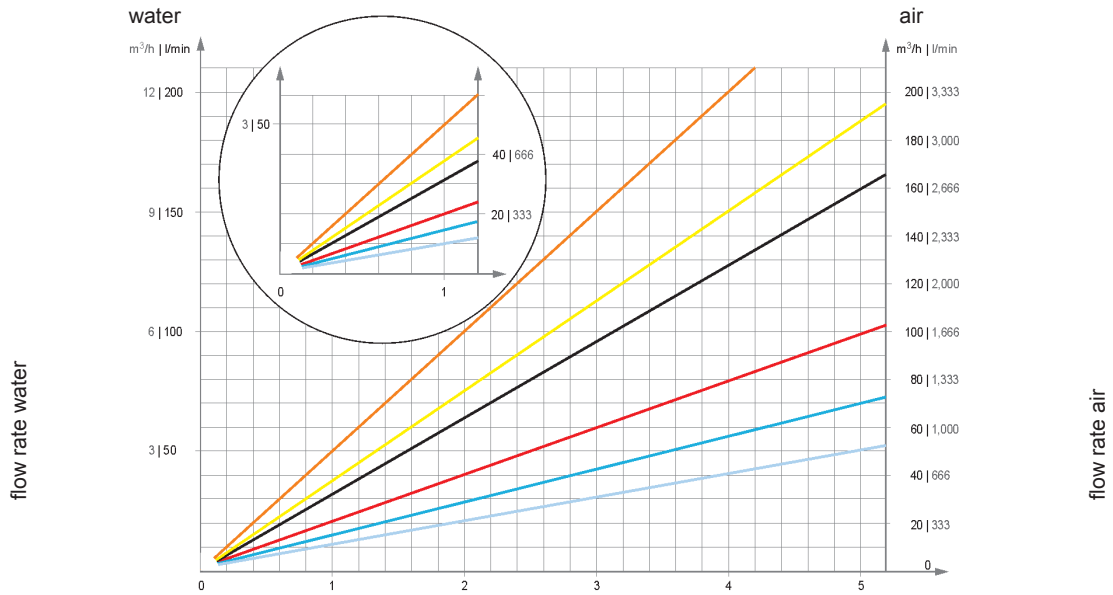

Cv value water

Cv value air

- $\Delta p = 0,5 \text{ bar}$
- $\Delta p = 1 \text{ bar}$
- $\Delta p = 2 \text{ bar}$
- $\Delta p = 5 \text{ bar}$

$\Delta p = 0,5 \text{ bar}, T = 293\text{K}, p_{\text{abs}} = 6 \text{ bar}, [\text{m}^3/\text{h}]$   
 $\Delta p = 1 \text{ bar}, T = 293\text{K}, p_{\text{abs}} = 6 \text{ bar}, [\text{m}^3/\text{h}]$

- 
- 

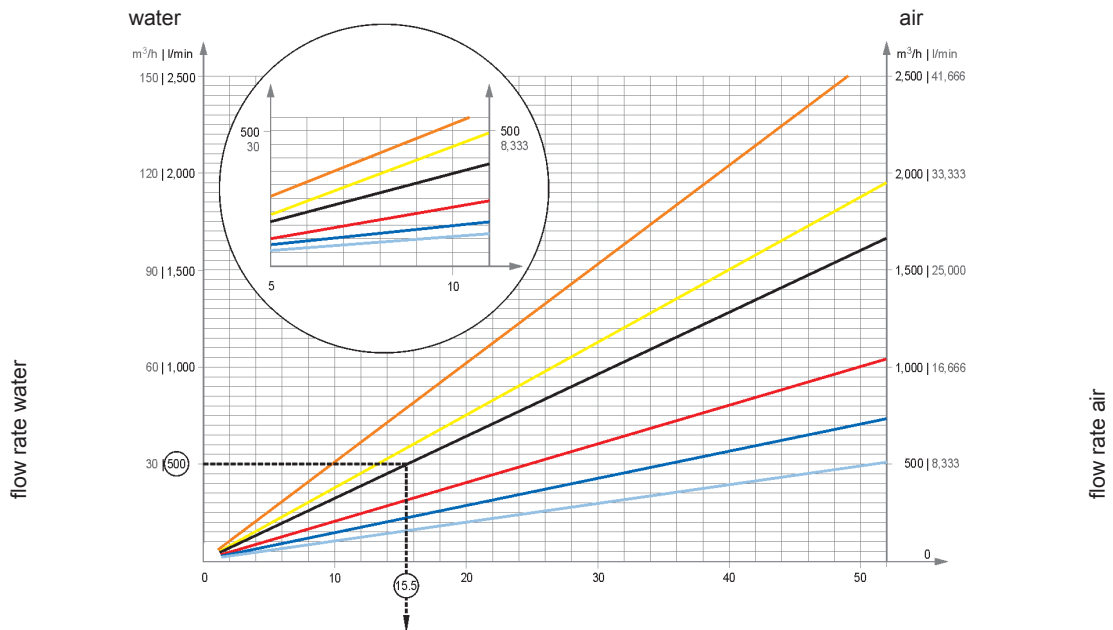

With given flow rate, choose your permissible  $\Delta p$  and thus be able to read off your minimum required Cv value. The allocations of Cv values to nominal sizes can be found in the technical charts. **Different viscosity? Please request a consultation.**





## Connection types

Design	Image	Description	Design	Image	Description
I		Cylindrical BSP metric thread, male thread to DIN EN ISO 228	XIII		Conical female NPT thread to US standard in accordance with ASME B1.20.1
II		Cylindrical BSP metric thread, female thread to DIN EN ISO 228	XIV		Male thread to SAE J 514-JIC 37° taper coupling (other taper couplings available)
III		Metric male thread with 24° sealing cone to DIN 2353/8434, for cutting ring and union nut to DIN EN ISO 8434-1 (no scope of supply), light- or heavy-duty range	XV		Reusable hose connection for plastic tube, complete with union nut
IV		Metric male thread with 24° sealing cone to DIN 2353/8434, for cutting ring and union nut to DIN EN ISO 8434-1 (no scope of supply), elongated for 10 mm bulkhead mounting, light- or heavy-duty range	XVI		Reusable hose connection for plastic tube, complete with spring washer, locknut, and union nut, elongated
V		Metric male thread with 60° sealing cone to DIN 7631, for taper coupling to DIN 3863 and union nut to DIN 3870	XVII		Cylindrical BSP metric thread, female thread to DIN EN ISO 228, flat-sealing, short
VI		Metric male thread with 60° sealing cone to DIN 7631, thread elongated for max. 10 mm bulkhead thickness	XVIII		SAE flange for pipe AD 64 4 x M 20 44.5 x 96.8
VII		Cylindrical BSP metric thread, male thread to DIN EN ISO 228/BS 5200 with 60° sealing cone	XIX		Weld stub adapted to DIN 2559
VIII		Cylindrical BSP metric thread, male thread to DIN EN ISO 228, threaded end to DIN 3852-2 Form B	XXI		Metric ISO standard thread, male thread to DIN 13
IX		Cylindrical BSP metric thread, male thread to DIN EN ISO 228, threaded end to DIN 3852-11 Form E for profile sealing ring or O-ring (O-ring not supplied)	XXII		Metric ISO standard thread, female thread to DIN 13
X		Cylindrical BSP metric thread, female thread to DIN EN ISO 228, screwed end to DIN 3852-2 Form X for profile sealing ring or O-ring (O-ring not supplied)	XXIII		Through type adaptor
XI		Hose connection, single or multiple ribs depending on the type and size	XXIV		Self-sealing adaptor
XII		Tapered male NPT thread to US standard in accordance with ASME B1.20.1	<b>Additional connections for your individual application might be possible on request!</b>		



## Catalogue - Guide



**Do any of these  
operating conditions  
apply for you?**

Coupling under pressure?

Particular temperature ranges?

Viscosity divergent from  
catalogue details?

Pulsating pressures?

Special media  
(aggressive, toxic, etc.)?

Please note the  
relevant **warning**  
notices in the  
catalogue and be sure  
to get in contact  
with our advisors!

---

### For standard solutions

1. Choose pressure range,
2. Choose appropriate series/type,
3. Select desired  
quick coupling system,
4. Request advice and an offer

---

### For customized solutions

1. Explore technical options,
2. Request advice and an offer

We would be happy to provide you with support and advice. Please contact us:



+49 (0) 2129 / 567-405



tk@walther-praezision.de





## Search quick and safe no need to look any further!

### Get information

Here you find many information on standardisation and technology related to quick coupling systems.

### Mini-couplings up to 500 bar / 2,750 psi

In this product range, you find compact quick couplings that are also suitable for vacuums while coupled.

### Quick coupling systems up to 110 bar / 1,600 psi

This product range includes more than 15 different quick coupling series in one side and both sides self-sealing designs.

### Quick coupling systems up to 250 bar / 3,625 psi

For all applications that require easy operation and higher pressure ranges.

### Quick coupling systems up to 2,000 bar / 29,000 psi

This is the right place if you are looking for high pressure quick couplings up to nominal bore 50 made of steel or stainless steel.

### Tailor-made quick coupling systems

Here you find many successful solutions, e.g. for emergency release applications, assembly-aid or temperatures of  $-252^{\circ}\text{C}$ .

### Multi-couplings and docking systems

These are used wherever quick and safe connection of several lines needs to take place simultaneously.

### Protection elements, hose lines and other accessories

This product range includes ideal complementary products for our quick coupling systems.



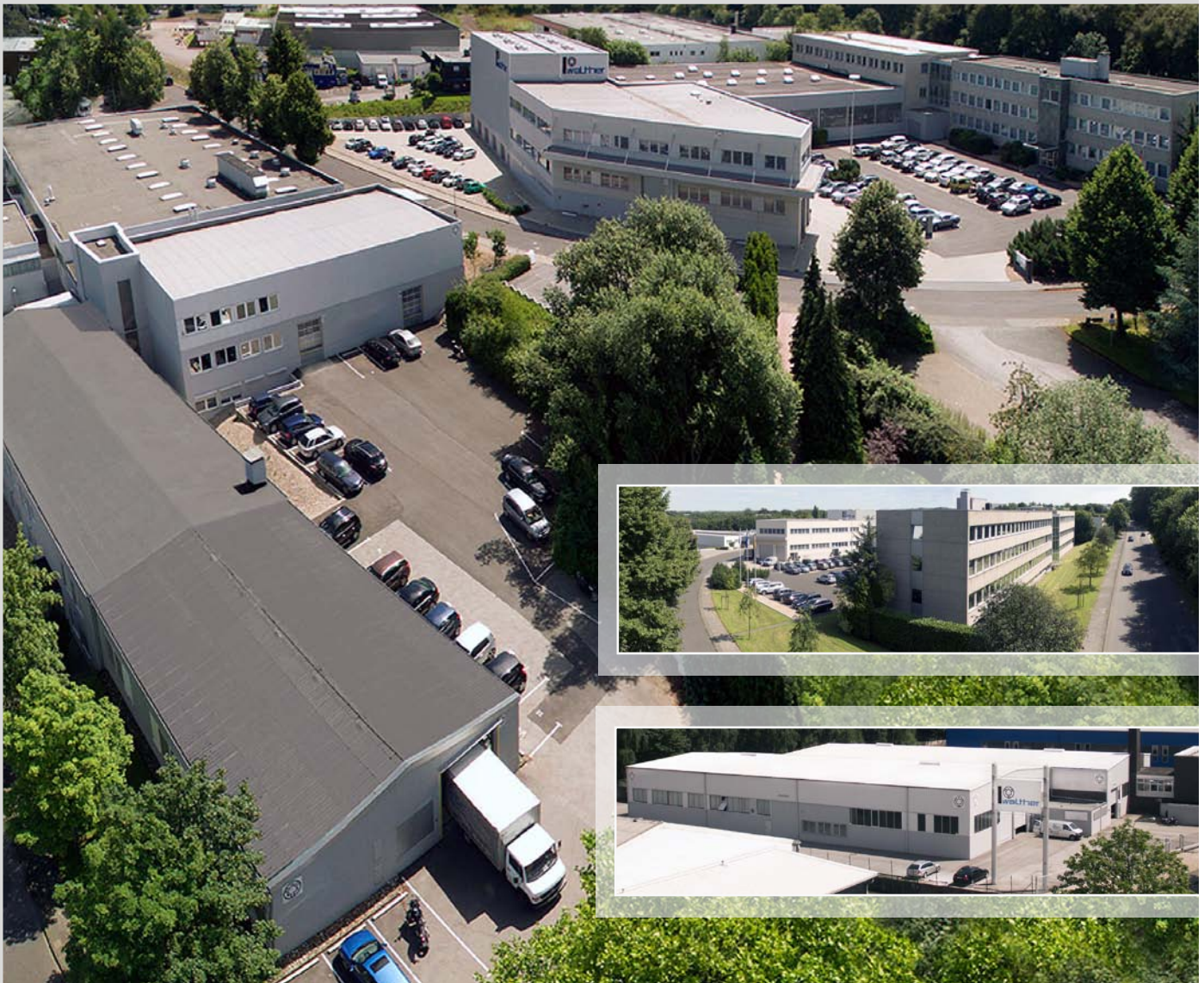

## Your safe connection

WALTHER-PRÄZISION grew from the requirement of its founder, Carl Kurt Walther, to quickly, comfortably and safely connect and disconnect the supply lines of his own manufacturing facilities and range of machinery (Maschinenfabrik Carl Kurt Walther, Wuppertal, founded 1931). Convinced of the technical and economic advantages of the coupling application, WALTHER-PRÄZISION started offering the first series on the German market.



## Quick information

Glossary/Technical terminology and charts	4
Media - Material - Seals - Resistance chart	7
Valve types and properties	9
Part number structure - series	11
Part number structure - nominal bore	12
Part number structure - product types	13
Part number structure - connection types	14
Part number structure - materials	16
Part number structure - seals	18
Part number structure - additional options	19
Our commitment/certificates	21
Safety instructions	22
Advice and service	23

We would be happy to provide you with support and advice. Please contact us:



+49 (0) 2129 / 567-405



tk@walther-praezision.de





## Glossary/Technical terminology

<b>ATEX</b>	Directive 2014/34/EU for equipment and protective systems intended for use in potentially explosive atmospheres. For WALTHER quick couplings that comply with this Directive, the part number key is suffixed with -EX.
<b>BA</b>	Both sides self-sealing quick coupling, abbreviation used with Cv values and flow volumes
<b>CIP capability</b>	Marked products that can be almost completely cleaned from media residues without disassembly.
<b>Clean Air Act</b>	Abbreviation for "Technical Instructions on Air Quality Control" according to VDI 2440. It is the "First General Administrative Regulation Pertaining to the Federal Emission Protection Law" and includes emission values as well as corresponding measurement and calculation methods. The part number key is suffixed with -TA.
<b>Cv value</b>	Dimensionless flow constants from WALTHER are used instead of the Kv value. The Cv value gives the flow capacity of water at 20°C in gal/min at a pressure drop of 1 lb/sq. in. an. Conversion: 1 Kv = 0.86 Cv; 1 Cv = 1.17 Kv. The measurements are performed in compliance with DIN EN 60534 with water at 20°C and $\Delta p = 1$ bar. Note: A flow velocity of 8 m/sec should not be exceeded during interpretation. See also Kv value.
<b>DIN EN 10204-2.2</b>	Standard for factory test certificates, material designation of certification, or additional certification of pressure and leak tests
<b>DIN EN 10204-3.1</b>	Standard for specific acceptance test certificates obtainable from material certificates issued by steel suppliers, or from WALTHER for stainless steel or similar materials, or additional certification of pressure and leak tests. The part number key is suffixed with -BB.
<b>DIN EN 61373</b>	Standard for the requirements of railway vehicles for tests with noise-inducing vibration/shock tests of pneumatic components.
<b>DK</b>	Thru-type coupling, abbreviation used with Cv values and flow volumes
<b>EA</b>	One side self-sealing quick coupling, abbreviation used with Cv values and flow volumes
<b>End plug</b>	An end plug is also a component of the coupling fitting. On the one hand, it holds the valve mounting parts, and on the other, it serves as a customer connection.
<b>FDA</b>	FDA-compliant version, where FDA is an abbreviation for the United States Food and Drug Administration. The part number key is suffixed with -FD.
<b>FF</b>	Abbreviation for "oil- and grease-free" products. For WALTHER quick couplings that conform to this grade, the part number key is suffixed with -FF.
<b>FL</b>	Abbreviation for "free from enamel flow-disturbing substances". For WALTHER quick couplings that conform to this grade, the part number key is suffixed with -FL.
<b>GW</b>	Abbreviation for a product design for use in gas and water applications in industrial environments. For WALTHER quick couplings that conform to this grade, the part number key is suffixed with -GW.
<b>Kv value</b>	Dimensionless flow constants the Kv value gives the flow capacity of water at 20°C in m <sup>3</sup> /h at a pressure drop of 1 bar. Conversion: 1 Kv = 0.86 Cv; 1 Cv = 1.17 Kv. The measurements are performed in compliance with DIN EN 60534 with water at 20°C and $\Delta p = 1$ bar. <b>Note:</b> A flow velocity of 8 m/sec should not be exceeded during designing. See also Cv value.





## Glossary/Technical terminology

<b>Leak-tightness</b>	All WALTHER quick couplings exhibit as standard a sealing performance of $10^{-3}$ mbar l/s. Leakage-free connection is in principle physically impossible.
<b>Leakage volume</b>	The volume released during disconnection. The leakage volume therefore must not be confused with the leak-tightness.
<b>Material</b>	The combination of base materials (steel, stainless steel, brass, etc.), sealing materials (NBR, FKM, EPDM, etc.), consumables and supplies (paints, lubricants, etc.) and surface coatings are decisive in determining the properties of the quick coupling.
<b>NB/BD</b>	Nominal bore as the diameter of a circular area, which is at least present over the entire flow path of the fitting.
<b>p max.</b>	Description for the maximum permissible operating pressure including pressure peaks for a coupled quick coupling system
<b>PED</b>	Abbreviation for Pressure Equipment Directive (PED) 2014/68/EU replaces 97/23/EG
<b>Purity/cleanliness</b>	Our coupling systems are delivered with the usual industrial cleanliness. Proper rinsing/cleaning is necessary before use in the context of purity classes.
<b>Q</b>	Flow volumes in $m^3/h$ or $l/min$ , the volume of a medium that can be transported through the quick coupling based on determinations of the time interval, temperature and permitted pressure difference. The measurements are performed in compliance with DIN EN 60534 with water at $20^\circ C$ and $\Delta p = 1$ bar. Note: A flow velocity of 8 m/sec should not be exceeded during designing.
<b>Service life</b>	The service life of the quick coupling system is determined based on both the chemical load of the fed media and, crucially, numerous external influences. Details on the warranty period are therefore not possible to specify or only possible on the basis of defined attempts.
<b>SIP capability</b>	Marked products that can be sterilised or disinfected by killing all germs, such as through the use of steam, without disassembly.
<b>Surface coating</b>	The wear and corrosion resistance of the treated base materials is purposefully increased through coating (such as chromium-plating, nickel-plating and zinc-plating).
<b>Vacuum</b>	A vacuum is colloquially described as a pressure condition with an internal pressure that is lower than the atmospheric external pressure.
<b>VO No. 1935/2004</b>	Regulation (EG) No. 1935/2004 of the European Parliament and the Council on materials and articles intended to come into contact with food. Formerly: Directive 80/590/EWG and 89/109/EWG. The part number key is suffixed with -EF
<b>WEDISO</b>	In the case of special material or seal versions, the part number key is presented as a combination of letters from AAAA to ZZZZ.
<b>Y / Z design</b>	Both special technical versions and additional options fall under this part number identification. Series/types with or without this part number identification may not be coupled with each other or only with special notice.



## Glossary/Technical terminology and charts

Diameter Millimetre / Inch		Diameter Inch / Millimetre		Temperature °C / °F		Temperature °F / °C	
Millimeter	Inch	Inch	Millimeter	°C	°F	°F	°C
1	0.04	1/16"	1.59	-252	-421	-450	-268
2	0.08	1/8"	3.16	-196	-320	-350	-212
3	0.12	1/4"	6.35	-50	-58	-60	-51
4	0.16	3/8"	9.53	-40	-40	-40	-40
5	0.20	1/2"	12.70	-30	-22	-20	-29
6	0.24	5/8"	15.88	-20	-4	-10	-23
7	0.28	3/4"	19.05	-10	14	5	-15
8	0.32	7/8"	22.23	-5	23	15	-9
9	0.35	1"	25.40	0	32	30	-1
10	0.40	1 1/4"	31.75	10	50	60	15
20	0.79	1 1/2"	38.10	20	68	90	32
30	1.18	1 3/4"	44.45	30	86	120	49
40	1.58	2"	50.80	40	104	150	66
50	1.97	2 1/4"	57.15	50	122	180	82
60	2.36	2 1/2"	63.50	60	140	210	99
70	2.76	2 3/4"	69.85	70	158	250	121
80	3.54	3"	76.20	80	176	300	149
				90	194	350	177
				100	212	400	204
				150	302	450	232
				200	392	500	260
				250	482	600	316
				300	572	700	371
				800	1,472	1,500	815
Pressure bar / psi		Pressure psi / bar		Temperature/Saturated steam °C / bar		Medium mPa at 20 °C	
bar	psi	psi	bar	Temp. °C	S pressure bar	Dynamic viscosity	(mPa at 20 °C)
1	14.50	10	0.69	100	1.01	Diethyl ether	0.23
5	72.52	100	6.89	105	1.21	Drinking water	1
10	145.04	150	10.34	110	1.43	Transformer oil	30
15	217.55	200	13.79	115	1.69	Hydraulic oil HLP 68	195
20	290.07	300	20.68	120	1.99	Glycerin (pure)	4,190
30	435.11	400	27.58	125	2.32	Honey	10,000
40	580.14	500	34.47	130	2.70	Tar	100,000
50	725.18	600	41.37	135	3.13	Printing inks	10,000,000
60	870.21	700	48.26	140	3.61		
70	1,015.25	800	55.16	145	4.16		
80	1,160.28	900	62.05	150	4.76		
90	1,305.32	1,000	68.95	200	15.54		
100	1,450.35	2,000	137.90	250	39.74		
200	2,900.70	3,000	206.84				
300	4,351.05	4,000	275.79				
400	5,801.40	5,000	344.73				
500	7,251.75	10,000	689.48				
1,000	14,503.50	20,000	1,378.95				
1,500	21,755.25	30,000	2,068.43				
2,000	29,007.00	40,000	2,757.90				
2,500	36,258.75	50,000	3,447.38				
3,000	43,510.50	60,000	4,136.85				



## Media - Materials - Seals - Resistance chart

### Resistance index:

resistant : +  
 conditional: O  
 non-resistant: -  
 empty: please enquire

	Galvanised steel	Passivated brass	Stainless steel No.1.4404/1.4571	Polyamide / PA 11/12	Polyacetal resin / POM	to DIN/ISO 1629		
						NBR	FKM	EPDM
Acetate (ethyl- and amyl-)	+	+	+	+	+			+
Acetic acid 10%	-	+	-	+				+
Acetone	+	+	+	+	+			+
Acetylene	+	+	+	+	+	+	+	+
Aircraft engine oil/turbine oil	+	+	+	+	O	+	+	
Alkaline	-	O	+	+	O			+
Alum		-	+		+	+	+	+
Ammonia solution	-	-	+	O	O	+	+	+
Ammonia, liquid	O	-	+	+	-			+
Ammonium nitrate	+	-	+			+	+	+
Ammonium sulphate solution	-	-	+	+	+	+		+
Amyl alcohol	+	+	+	+	+			+
Aniline	+	-	+	O	O			+
Aviation fuel, jet fuel	+	+	+	-	+	+	+	
Barium chloride	+	+	O	+	+	+	+	+
Barium sulphide		O	+	+		+	+	+
Benzene	+	+	+	+	+	+	+	
Benzol	+	+	+	+	+		+	
Blast furnace gas	O	+	+	-	O		+	
Borax	+	+	+				+	+
Butane	+	+	+	+	+	+	+	
Butyl alcohol	-	+	+	+	+	+	+	+
Calcium hydroxide	+		+	+	O		+	+
Carbon dioxide, dry		+	+	+		+	+	+
Carbon	+		+				+	
Carbon disulphide		+	+	-	+		+	
Carbonic acid	-	+	+	+	+		+	+
Carbonic acid, liquid	-	+	+	+	O		+	+
Caustic brine	-	-	+	O	O		+	+
Caustic soda	-	O	+	+	+			+
Chromic acid	-	-	O	O	-		+	
Citric acid	-		+	-	O	+	+	+
Coal gas	O	+	+	+	+		+	
Coal tar oil	+		+	+	O		+	
Coke oven gas	O	+	+	O	O		+	
Compressed air	+	+	+	+	+	+	+	
Cooling water	O	O	+	+	O	+	+	
Copper chloride			O	-		+	+	+
Creosote	+		+				+	
Cresol	+	O	+	-	-		+	
Cresol/cresylic acid	+		+				+	
Crude oil	+	+	+	+	+	+	+	
Cyclohexane			+			+	+	
Diesel oil	+	+	+	+	+	+	+	
Diesel oil up to 120°C	+	O	+	O	-		+	
Essential oils	+	+	+	+	+		+	
Ethanolamine	+		+				+	+
Ethyl alcohol, technical	+		+	+	+		+	+
Ethylene	+	+	+	+	+	+	+	
Formalin	+	+	+	+	O	+	+	+
Formic acid	-	O	O	-	-			+
Freon F 11-12	+	+	+	+	+	+	+	
Gas containing naphthalene	+	+	+	+	O		+	
Glucose		+	+	+	+	+	+	+
Glycerine	+	+	+	+	+	+	+	+
Glycol	O	+	+	+	+	+	+	+
Heat transfer oil DF150R 200°C/up to 300°C	O		+	-	-			
Heating oil	+	+	+	O	-		+	
Heating oil DF150R up to 180°C, sometimes 250°C	+		+	-	-			
Heating oil S	+	+	+	O	+		+	
Helium	+	+	+	+	+	+	+	+
Hexane	+		+	+	+	+	+	
Hot air up to 120°C	+	O	+	O	O		+	+
Hot air up to 200°C	+		+	-	-		+	
HSA - Oil-in-water emulsion VDMA 24317	-		+				+	+
HSB - Water-in-oil-emulsion VDMA 24317	-		+				+	+
HSC - Glycol-water mixture VDMA 24317	-		+				+	+
HSD - Synthetic oils VDMA 24317	O		+				+	
Hydraulic oil, mineral-based	+	+	+	O	O	+	+	
Hydraulic pressurised fluids, SE	O		+				+	
Hydrocarbons	+	O	+	+	+		+	
Hydrocarbons (highly-chlorinated)	O		+				+	
Hydrocyanic acid	+	-	+				+	+
Hydrogen			+				+	+
Hydrogen gas	O	O	+				+	+
Hydrogen peroxide	-	-	+	+	-		+	
Hydrogen sulphide, dry		+	+		O	+	+	+
Hydrogen sulphide, moist		O	+	+	-		+	
Illuminating gas	+	+	+	+	+		+	
Isopropyl alcohol	+		+	O	+		+	+
Kerosene JP1	+	+	+	+	+		+	
Ketone (ethyl methyl)	+	+	+	+	+		+	+
Linseed oil	+	+	+	+	+	+	+	
Lubricating oil			+	+	+	+	+	





## Media - Materials - Seals - Resistance chart

### Resistance index:

resistant : +  
 conditional: O  
 non-resistant: -  
 empty: please enquire

	Galvanised steel	Passivated brass	Stainless steel No.1.4404/1.4571	Polyamide / PA 11/12	Polyacetal resin / POM	to DIN/ISO 1629		
						NBR	FKM	EPDM
Magnesium carbonate	+		+	+	+	+	+	+
Magnesium hydroxide	+	O	+	+	+	+	+	+
Magnesium sulphate		-	+	+	+	+	+	+
Mercury	+	-	+	+	+	+	+	+
Methane	+	+	+	+	+	+	+	
Methanol	+	+	+	+	+			+
Methyl alcohol	+	+	+	O	+			+
Methyl benzol	+		+				+	
Methyl ethyl ketone	+		+	O				+
Milk		-	+	+	+	+	+	+
Mineral oil	+	+	+	+	+	+	+	
Naphta	+		+	+	+	+	+	
Naphthalene	+	+	+	+	+		+	
Naphthenic acid	+		+				+	
Natural gas/synthetic	O	+	+	+			+	
Natural gas	+	+	+	+	+	+	+	+
Nitric acid up to 35%	-	-	+	-	-		+	
Nitro solvent (no synthetic resin thinner)	+	+	+	-	+		+	+
Nitrogen	+	+	+	+	+	+	+	+
Oleic acid	+	-	+	O	+	+	+	+
Olein fatty acid	+		+	+	+	+	+	
Oxalic acid	O	O	-	O	-		+	+
Oxygen (grease-free)	O	+	+	+	O			+
Paraffin	+	O	+	+	+	+	+	
Pentachlorophenol	+						+	
Petroleum	+	+	+	+	+	+	+	
Petroleum ether		+	+	+	+	+	+	
Petroleum ether, refined	+		+			+	+	
Phenol solution 1%, 20°C	O	+	+	-	-		+	
Phosphate ester	O		+				+	
Phosphoric acid 10%			+	-	-		+	+
Plant oils	+		+	+	+	+	+	
Potassium cyanide	+	-	+	+	O	+	+	+
Potassium dichromate	+	-	+	-	O		+	+
Potassium hydroxide	-	-	O	O	O			+
Potassium sulphate	+	O	+	+	+	+	+	+
Propane gas	+	+	+	+	+	+	+	+
Seawater		-	+		+	+	+	+
Soap solution	-	O	+	+	O	+	+	+
Soda solution	-	O	+	+	O		+	+
Sodium acetate			+	+	+			+
Sodium bicarbonate			+	+	+	+	+	+
Sodium carbonate	+		+	+	+	+	+	+
Sodium chloride			O	+	+	+	+	+
Sodium cyanide	+		+		O	+	+	+
Sodium sulphide	+	O	+			+	+	+
Steam up to 140°C	-	O	+	-	-			+
Steam up to 250°C	-		+	-	-			
Sulphur dioxide, gas		+	+					+
Synthetic resin thinner, without acetone/ketone	+	+	+	O	O		+	
Tar	+	O	+	O	O			+
Titanium tetrachloride	+		+				+	+
Toluene, dry	O	+	+	+	+			+
Town gas	+	+	+	+	+	+	+	+
Transformer oil	O	O	+	+	+	+	+	
Transmission oil	+		+		+	+	+	+
Trichloroethylene	+	O	+	O	-			+
Turbo oil, turbine oil (MIL-L-7808)	O	O	+	+	O	+	+	+
Vacuum (strengthened valve springs)	+	+	+	+	+	+	+	
Water above 80°C	O	O	+	O	-		+	+
Water up to 80°C	O	+	+	O	O	+	+	+
Water, deionised			+				+	+
Water, demineralised			+	+			+	+
Water, distilled			+	+	+			+
Xylene	O	O	+	+	+			+

### General resistance properties

The details given here constitute only a small selection of all possible material combinations and are subject to change and only for initial orientation. They apply to a) pure substances, b) room temperature if nothing else is specified, c) aqueous solutions of moderate temperature in the case of salts, acids, etc., and d) non-aggressive conditions.

Other factors to be noted are the site of operation, the country-specific requirements and the exact composition of the medium.

Many other material combinations are available for all other substances, aggregate states, etc. not specified here, be these pure substances or homogeneous/heterogeneous mixtures. WALTHER combines the optimal suitable materials with the function and design of the quick coupling to create a tailor-made and safe solution: also with special materials such as **hastelloy** and seals such as **FFKM** when required.



## Valve types and properties



### Coupling valve with valve-opening poppet/pointed valve series **LP** (NB 6-19)

**Properties:**

- Non-squirting during connection
- Flow-optimised
- For general applications

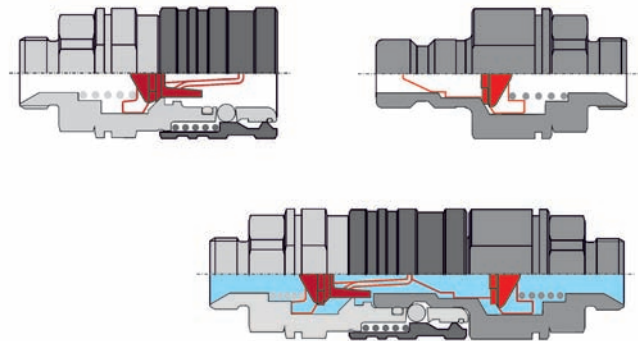

### Pointed valve series **LP**, **MD** and **HP**

**Properties:**

- Flow-optimised
- For general applications

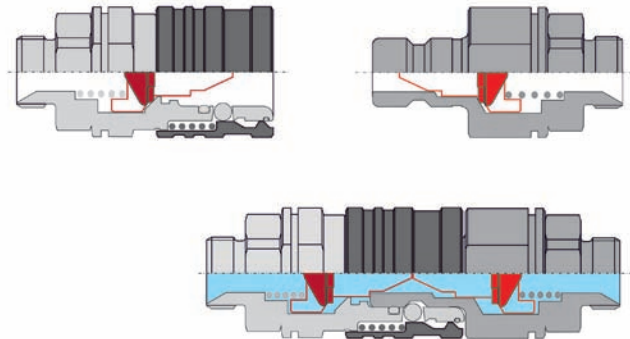

### Ring valve series **HP**

**Properties:**

- Impulse-load capability
- For high and maximum pressure ranges
- With vibration safety device

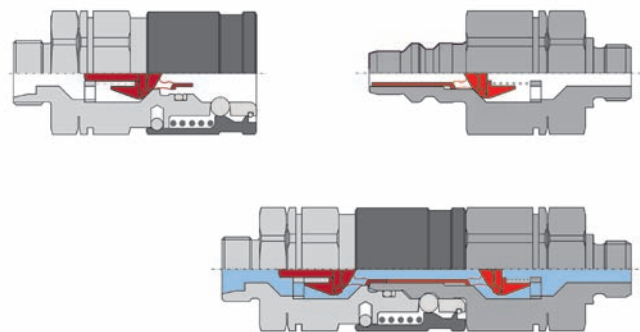



## Valve types and properties



### (Ball face) Clean break valves series BF

**Properties:**

- Non-squirting during connection
- Minimal leakage volume during disconnection
- Suitable for sensitive media
- With cleaning position

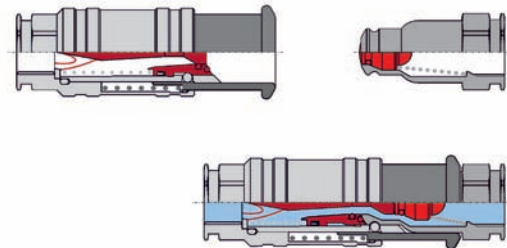

### (Flat face) Clean break valves series HC

**Properties:**

- Non-squirting during connection
- Minimal leakage volume during disconnection
- Suitable for self-lubricating media
- For high and ultra high pressures

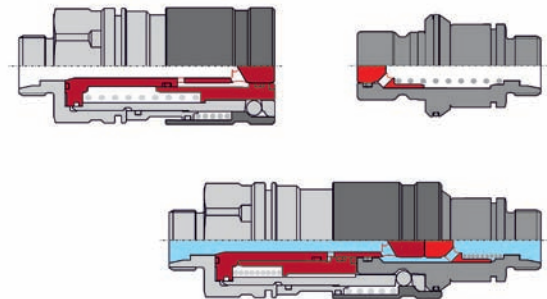

### Ball valve type 03-005

**Properties:**

- Low leakage volume during unpressurised disconnection
- Suitable for water-soluble lacquers and synthetic resins

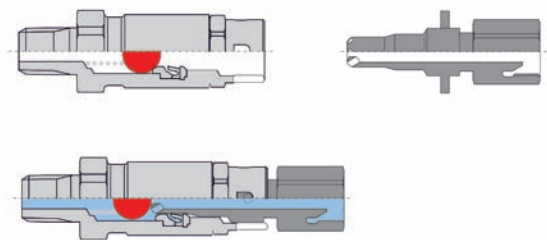

### Without valve series EH

**Properties:**

- Maximum flow capacity
- Mostly laminar flow conditions
- Suitable for high viscosities (high viscosity = pasty)
- Suitable for lacquers and paints

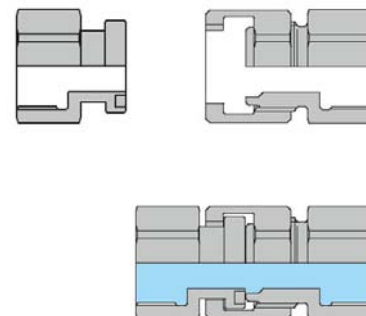





## Part number structure - series

**LP - 006 - 0 - WR021 - 01 - 2 - GL - ...**

Please note that the delivery time may vary in the case of larger orders depending on the series.

Series / Type	Field of use
02-	Miniature hydraulics up to 500 bar
06-	Water, compressed air
07-	Water, compressed air
11-	Heat transfer oil up to 310°C
BF-	Aggressive chemicals, non-lubricating media, solvents, gases
CG-	Coolants (water-glycol mixture, cooling oils)
CK-	Cooling water, mild acids and alkaline solutions
CN-	Chemical liquids, non-lubricating media, solvents, gases
CP-	Hydraulic fluids, self-lubricating media, water
CT-	Liquids, gases
EH-	Viscous to pastes, powders, foodstuffs, pharmaceuticals
FF- / 15-	Hydraulic fluids, self-lubricating media
HC-	Hydraulic fluids, self-lubricating media
HP-	Hydraulic fluids, chemical media, water, gases
KL-	Water, compressed air, mild acids and alkaline solutions
LP-	Water, compressed air, fuel, oils, miscellaneous liquids and gases
LS-	Compressed air - supply side
LT-	Compressed air - tool side
LV-	Water, fuel, compressed air, oils, chemistry, medical technology
MD-	Hydraulic fluids, chemical media, water, gases
SG-	Hydraulic fluids, chemical media, water, gases
SK-	Dust protection made of plastic
SL-	Dust protection made of plastic
SP-	Water, compressed air, fuel, oils, miscellaneous liquids
SW-	Compressed air spiral-coil hose
UF-	Gaseous/liquid media, non-interchangeability
UM-	Laboratory, medical and nuclear installations with gas, liquid or vacuum lines, non-interchangeability



## Part number structure - nominal bore

**LP - 006 - 0 - WR021 - 01 - 2 - GL - ...**

For an initial estimate of the coupling size, we compare our nominal bore in millimetres with the nominal bore in inches. The requirement for the flow properties are important for the selection of the right size - **not the connection of the fitting!**

Nominal bore in millimetres	Size in inches
-003-	1/8" - 1/4"
-004-	1/8" - 1/4"
-005-	1/8" - 1/4"
-006-	1/4" - 1/2"
-007-	1/4" - 1/2"
-008-	1/4" - 1/2"
-009-	1/4" - 1/2"
-010-	3/8" - 1/2"
-011-	3/8" - 3/4"
-012-	1/2"
-016-	1/2" - 3/4"
-019-	3/4"
-020-	3/4"
-023-	3/4" - 1"
-025-	1"
-030-	1 1/4"
-032-	1 1/4"
-038-	1 1/2"
-040-	1 1/2"
-050-	2"
-080-	3"
-100-	4"



## Part number structure - product types

LP-006-0-WR021-01-2-GL-...

The different product types in purely schematic form, with regard to the part number structure, are presented here. The following series and types described in the catalogue can deviate from these both optically and technically.

**Warning:** Different series/types and different materials must not be coupled together or must only be coupled under specific advice, since this can otherwise lead to property damage and personal injury with fatal consequences.



**-0-** Self-sealing coupling  
= coupling with valve

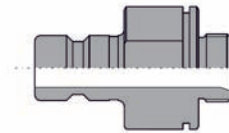

**-1-** Thru-type adaptor  
= adaptor without valve

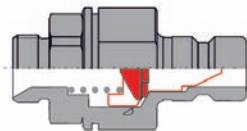

**-2-** Self-sealing adaptor  
= adaptor with valve



**-4-** Thru-type coupling  
= coupling without valve

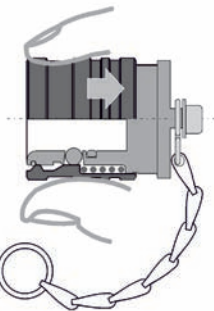

**-5-** Dust cap  
= protection element for adaptor

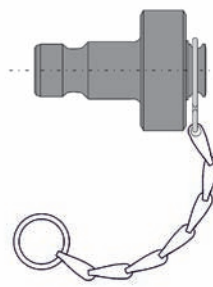

**-6-** Dust plug  
= protection element for coupling



## Part number structure - connection types

**LP-006-0-WR021-01-2-GL-...**

**On request**, we will deliver our quick coupling systems with all conventional thread types and connection types, even as **45° or 90° versions**. By default, not all listed connection types are available in all materials! Please refer to the current price list for further information. Please note that the maximum permissible operating pressure of the connection and not the quick coupling system must be considered when determining the operating pressure. Our standard connection types are as follows.

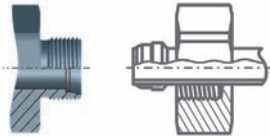
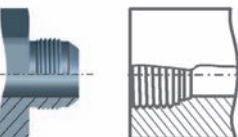
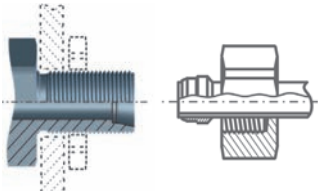
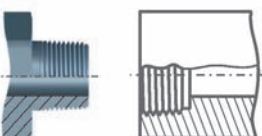
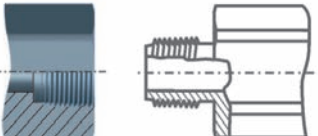
<p><b>-D....-</b></p>	<p>Metric male thread with 60° sealing cone to DIN 7631, for sealing cone to DIN 3870, also available as bulkhead mounting</p>	<p><b>V</b></p>	
<p><b>-L....-</b> <b>-S....-</b></p>	<p>Metric male thread with 24° sealing cone to DIN 2353/8434, for cutting ring and union nut to DIN EN ISO 8434-1 (no scope of supply), light- or heavy-duty range</p>	<p><b>III</b></p>	
<p><b>-LH...-</b></p>	<p>Male thread to SAE J 514-JIC 37° sealing cone</p>	<p><b>XIV</b></p>	
<p><b>-LV...-</b> <b>-SV...-</b></p>	<p>Metric male thread with 24° sealing cone to DIN 2353/8434, for cutting ring and union nut to DIN EN ISO 8434-1 (no scope of supply), elongated for 10 mm bulkhead mounting, light- or heavy-duty range</p>	<p><b>IV</b></p>	
<p><b>-NP0..-</b></p>	<p>Tapered NPT thread, male thread to US standard ANSI/ASME B 1.20.1. A suitable sealant (such as sealing adhesive, PTFE tape or hemp) that is not included in the scope of delivery is needed for customer assembly.</p>	<p><b>XII</b></p>	
<p><b>-NP5..-</b></p>	<p>Tapered NPT thread, female thread to US standard ANSI/ASME B 1.20.1. A suitable sealant (such as sealing adhesive, PTFE tape or hemp) that is not included in the scope of delivery is needed for customer assembly.</p>	<p><b>XIII</b></p>	



## Part number structure - connection types

LP - 006 - 0 - WR021 - 01 - 2 - GL - ...

<p><b>-SL...-</b></p>	<p>Hose connection, from single to multi-ribbed depending on the type and size, for industrial hoses. A suitable hose clamp that is not included in the scope of delivery is needed for customer assembly.</p>	<p>XI</p>	
<p><b>-VR...-</b></p>	<p>Cylindrical BSP metric thread, male thread to DIN EN ISO 228/BS 5200 with 60° sealing cone</p>	<p>VII</p>	
<p><b>-WB...-</b></p>	<p>Cylindrical BSP metric thread, male thread to DIN EN ISO 228, screwed end to DIN 3852-2 Form B with small sealing cone</p>	<p>VIII</p>	
<p><b>-WE...-</b></p>	<p>Cylindrical BSP metric thread, male thread to DIN EN ISO 228, screwed end to DIN 3852-11 Form E for profile seal or O-ring. The seal necessary for customer assembly is not included in the scope of delivery.</p>	<p>IX</p>	
<p><b>-WR0...-</b></p>	<p>Cylindrical BSP metric thread, male thread to DIN EN ISO 228. A suitable sealant (such as sealing adhesive, PTFE tape or hemp) that is not included in the scope of delivery is needed for customer assembly.</p>	<p>I</p>	
<p><b>-WR5...-</b></p>	<p>Cylindrical BSP metric thread, female thread to DIN EN ISO 228. A suitable sealant (such as sealing adhesive, PTFE tape or hemp) that is not included in the scope of delivery is needed for customer assembly.</p>	<p>II</p>	
<p><b>-XX...-</b></p>	<p>Adaptations to your particular application: Special connections that do not comply with a general standard, such as special threads, angular couplings, and extremely extended couplings. <b>We are happy to advise you!</b></p>		<p>On request</p>





## Part number structure - materials

**LP - 006 - 0 - WR021 - 01 - 2 - GL - ...**

**On request**, we will deliver our quick coupling systems in all suitable material combinations (material and seal grades as well as surface finishes). Please note that the maximum permissible operating pressure of the quick coupling system including the connection type must be determined taking into account the material properties when determining the plant's operating pressure. The surface finishes described here, however, play no role in the determination of operating pressure. General information on the standard materials used is as follows.

### Stainless steel

- 01-** **1.4404/1.4571** (or equal-grade of high-grade stainless steels) are austenitic stainless chromium-nickel-molybdenum steels with low carbon content; 1.4571 with titanium stabilisation (AISI reference 316L/316ti).
- 02-** **1.4305** (or equal-grade of high-grade stainless steels) is an austenitic chromium-nickel steel alloyed with sulphur (AISI reference 303).
- 0A-** **1.4571** is a stainless austenitic chromium-nickel-molybdenum steel with titanium stabilisation (AISI reference 316ti).
- N2-** **1.4307** (or equal-grade of high-grade stainless steels) is an austenitic, more acid-resistant chromium-nickel steel (AISI reference 304L).
- W1-** **1.4418 QT900** (hardened and tempered), self-sealing adaptor made of 1.4418 QT900, all other housing parts made of 1.4404 (US reference F6Nm)

### Steel base material

- 11-** **Galvanised**, our components are free from hexavalent chromium (CR VI) and offer protection against corrosion.
- 12-** **Oil-burnished**, the components receive a weak protective layer through immersion in an acid or alkaline solution to prevent corrosion. Individual components are hardened to enhance strength. Not available with additional options FF/FL.
- 13-** **Chemically nickel-plated**, the components receive a nickel-phosphorus alloy coating as protection against wear and corrosion.
- 19-** **Galvanised/partially oil-burnished** (see description under -11- and -12-) Not available with additional options FF/FL.

### Brass base material

- 21-** **Passivated**, the produced passivation layer offers improved corrosion or tarnish protection against fingerprints or changes in appearance.
- 22-** **Chromium-plated**, the base material receives a galvanic coating as protection against wear and corrosion.
- 23-** **Nickel-plated**, the components are coated by electrolytic means. Nickel offers good protection against diluted acids, water and most alkalis, for example.
- 24-** **Chemically nickel-plated**, the base material receives a nickel-phosphorus alloy coating as protection against wear and corrosion.



## Part number structure - materials

**LP - 006 - 0 - WR021 - 01 - 2 - GL - ...**

### Aluminium base material

- 31-** **Silver anodised**, an aluminium coating process in which artificial oxidation is achieved using an anode current. This oxide coating has the benefit of colourability; in this case a translucent silver colour.
- 36-** **Red anodised**, an aluminium coating process in which artificial oxidation is achieved using an anode current. This oxide coating has the benefit of colourability; in this case a red colour.
- 39-** **Hard-coated**, a process that can only be carried out with certain grades of aluminium. The hard coating is formed into a cooled acid electrolyte through anodic oxidation. It serves to improve corrosion protection and wear.

### Plastics

- 40-** **Polyacetal resin (POM) grey**, is a homopolymer with good mechanical strength, dimensional stability and low moisture absorption.
- 45-** **Polyacetal resin (POM) white** (see description -40-)
- 46-** **Polyacetal resin (POM) black** (see description -40-)
- 50-** **Polyamide (PA) grey**, is a semi-crystalline technical thermoplastic with good toughness, good stress-cracking resistance and very good notched impact strength.
- 73-** **Polyvinyl chloride (PVC) soft, black**, is very tough and strain crack-resistant as well as weather-resistant.
- 74-** **Polyvinyl chloride (PVC) soft, grey** (see description -73-)
- PA-** **Polyamide (PA)** (see description -50-)
- PP-** **Polypropylene (PP)** is a semi-crystalline thermoplastic with excellent bending durability. Only partly weather-resistant.
- PV-** **Polyvinylidene fluoride or polyvinylidene difluoride (PVDF)** is an opaque, semi-crystalline, thermoplastic fluoroplastic.

### WEDISO

- A... - Z...-** A 4-digit identification formed of a combination of letters from AAAA to ZZZZ is assigned to special material or seal versions (**WEDISO**).



## Part number structure - seals

### LP - 006 - 0 - WR021 - 01 - 2 - GL - ...

The different seal grades with their typical properties, with regard to the part number structure, are presented here. Properties that deviate from these can appear depending on the application, temperature and concentration of the medium.

**Notice:** Not all seal grades are possible with all material grades and coupling series.

<b>-1-</b>	<p><b>NBR (Acrylonitrile butadiene rubber)</b> Has good mechanical properties, a low compression set, good low temperature behaviour, and a higher wear resistance. The material shows good resistance against hydraulic oils, mineral oils, petroleum products and oil-in-water emulsions, water glycols and animal and vegetable oils, benzene, flame-retardant oil-in-water emulsions (HFA liquids), water-in-oil emulsions (HFB liquids) and solutions of polymers in water (HFC liquids). Temperature range: -20°C to +80°C. Applications: Standard material for oil and fuel-resistant seals.</p>
<b>-2-</b>	<p><b>FKM / FPM (Fluoroelastomers)</b> Characterised by excellent resistance to high temperatures, ozone, weather conditions, oxygen, mineral oils, synthetic hydraulic fluids, fuels, aromatics, many organic solvents and chemicals. For applications in water and steam, the upper temperature limit stands at approx. +120°C. Through its low gas permeability, FKM is suitable for high-vacuum conditions and has a good resistance to flame-retardant oil-in-water emulsions, water-in-oil emulsions and anhydrous synthetic liquids. Temperature range: -15°C to +200°C. Applications: FKM is often used when NBR can no longer be used, due to reasons including high operating temperatures or inadequate resistance to chemicals.</p>
<b>-4-</b>	<p><b>EPDM (Ethylene-propylene-diene monomer)</b> Very good ageing stability under UV exposure and ozone exposure, also resistant to oxygen and diluted acids. EPDM shows an outstandingly good resistance to chemicals. Temperature range: -30°C to +140°C. EPDM is often FDA-compliant. Applications: Preferred material for use with glycol-based brake fluids and both hot water and hot steam.</p>
<b>-9-</b>	<p><b>PTFE (Polytetrafluoroethylene)</b> Intended for aggressive environments, high temperatures, high pressures and dry runs. Many PTFE composites are FDA-compliant. Working temperature range: -70°C to +250°C. PTFE seals require a special coupling design. Applications: Due to its suitability for aggressive media and its high temperature-resistance, PTFE is often used in the chemical and pharmaceutical industries, but also with high or especially low media and ambient temperatures.</p>
<b>-A... - Z...-</b>	<p><b>WEDISO (Material/Seal/Special Design)</b> A 4-digit identification formed of a combination of letters from AAAA to ZZZZ is assigned to special material or seal versions.</p>
<b>-A... - Z...-</b>	<p><b>FFKM (Perfluoroelastomers)</b> Are also encoded in a WEDISO. High-performance elastomer with excellent chemical properties, similar to those of PTFE and the elastic properties of FKM. Short-term temperature resistance up to 315°C. Temperature range: -15°C to +250°C. Applications: Perfluoroelastomers are used predominantly as materials in chemistry due to their high thermal and chemical resistance. Special compounds can be used with approval (i.e., FDA approval).</p>



## Part number structure - additional options

**LP - 006 - 0 - WR021 - 01 - 2 - GL - ...**

**Notice:**

The additional options and their combinations are not available for all coupling fittings. If you wish to combine several additional options, please contact our advisers.

**-BB-**

A documented production in accordance with DIN EN 10204 is required for proof of specified materials. Further specific tests can also be documented in the acceptance test certificate. These should be indicated in individual orders and require written confirmation from WALTHER.

**-DR-**

Mechanically non-interchangeable triangular fitting

**-EF-**

Design in accordance with Regulation (EG) No. 1935/2004, for quick couplings intended to come into contact with food. Preferred series: CT, CN, EH, BF.

**-EX-**

An ATEX-compliant design must be used in potentially explosive atmospheres. This corresponds to Equipment Group II/Category 2 of the Explosion Protection Directive 2014/34/EU.

**-FD-**

The coupling fitting is equipped with FDA-compliant sealing materials (FDA = Food and Drug Administration).

**-FF-**

An oil and grease-free design is required in the case of some industrial applications or media.

**-FL-**

To eliminate disturbances during painting, no enamel flow-disturbing substances (paint-wetting impairment substances) may be used that might be obscured by compressed air.

**-GG- / -EG-**

In special cases, such as in the case of unfavourable installation positions, high operating temperatures, large nominal bore, etc., the use of additional ring grips, made either of cast aluminium (GG) or stainless steel (EG), can greatly facilitate the handling of fittings.

**-GL-**

Smooth design, used predominantly with fittings made of stainless steel

**-GW-**

This design is intended for use in engineered gas installations in commercial and industrial gas applications.



## Part number structure - additional options

**LP - 006 - 0 - WR021 - 01 - 2 - GL - ...**

**Warning:**

The additional options and their combinations are not available for all coupling fittings. If you wish to combine several additional options, please contact our advisers.

<b>-KL-</b>	Identification for coupling fitting via laser. The identification can be individually selected.
<b>-OV-</b>	Without valve
<b>-R1- to -R5-</b>	Mechanically non-interchangeable round fitting (several versions)
<b>-RA-</b>	Radial safeguard against vibrations, standard with the HP series
<b>-RV-</b>	The service life and wear resistance are considerably improved under strong pulsating pressures and especially harsh operating conditions through the fitting of ring valves. These valves must not be coupled with standard valves.
<b>-SI-</b>	Many couplings are available with an additional axial positive-locking safety device. Disconnection is thus only possible once the safety sleeve and retaining ring have been pulled apart under spring force and twisted against each other by 90°. Both end positions-engaged and disengaged-are fastened by spring-loaded cams. The operator can be assured of correct locking and securing when he/she attempts to disconnect the coupling by pulling back the safety sleeve as a control measure. This is not possible in a secured state.
<b>-TA-</b>	Extended tests are carried out and documented in accordance with the Clean Air Act (TA-Luft) to VDI 2440 with regard to leak-tightness or compliance with the specific leakage rate.
<b>-VE-</b>	In the case of long compressed air piping, the use of a self-sealing coupling or self-sealing adaptor with a bleed-off valve is recommended on the hose connection side. The potential backlash during disconnection is thereby considerably reduced and the air can escape from the hose slowly.
<b>-VF-</b>	The self-sealing couplings and self-sealing adaptors must be fitted with strengthened valve springs to ensure the negative pressure (vacuum) capability of the fittings while disconnected.
<b>-VH-</b>	The locking sleeve is locked in a retracted state for easier operation. When attached to the fitting component, the locking sleeve automatically jumps forward to the locking position. This is why it must not be touched or obstructed during this process.
<b>-VI-</b>	Mechanically non-interchangeable square fitting
<b>-Y..- / -Z..-</b>	Both special technical versions and additional options fall under this part number identification. Series/types with or without this part number identification may not be coupled with each other or only with special notice.





## Our commitment/certificates

Four values form the corporate culture of **WALTHER-PRÄZISION** as the foundation of business activities:

**enthusiasm, appreciation, integrity and discipline.**

We live by these values in our business relationships with customers, suppliers and employees.

**WALTHER-PRÄZISION** strives to maintain a safe and healthy working environment for all employees and to simultaneously guarantee the safety and protection of company values.

Together with business partners, **WALTHER-PRÄZISION** wants to foster and ensure innovation and maximum performance in a sustainable manner.

Our philosophy of cooperation is based on mutual expectations and obligations: focus is placed on reliability, transparency, communication and sustainability.



### System certifications:

- **DIN EN ISO 9001:2015** - General quality assurance system  
Design/development, manufacture and distribution of mono-couplings, multi-couplings and docking systems
- **EN ISO 13485-2016** - Medical technology  
Design/development/manufacture and distribution of mono-couplings, multi-couplings, hose connector and connection systems for medical technology applications
- **Certification EN 9100** - Aerospace  
Astrium Space Transportation, Bremen / ASD / EASE
- **KTA 1401**  
VGB - Classification K5; K4 on request

### Product certification:

- Zulassung DIN IEC 61373
- Certificate Rolls-Royce Deutschland Ltd & Co KG
- Conformity assessment TÜV Saarland according to Explosion Protection Directive 2014/34/EU
- Type examination report, DEKRA
- DET NORISKE VERITAS (Norway)
- Federal Institute for Materials Research and Testing BAM, Berlin
- SVGW / SSGE (Swiss Gas and Water Industry Association)
- Germanischer Lloyd Oil and Gas
- Pressure Equipment Directive (PED)
- TÜV-Rheinland



## Safety instructions and liability



### Liability

**WALTHER-PRÄZISION assumes no liability and makes no guarantees for the completeness, accuracy and currency of the information made available in its print media, Internet presence and operating manuals. All specifications in the catalogue are subject to change. Changes and errors excepted. The same applies to images.**

Due to the different working modes and the versatile applications of quick coupling systems, WALTHER-PRÄZISION cannot guarantee with its dealership network that a particular quick coupling system is suitable for each specific application. Not all technical details to be considered during the selection of a quick coupling system are analysed. The user is personally responsible for the following after conducting their own analyses.

- For the safe operation and the observance of maintenance and servicing.
- The selection of their quick coupling system.
- Meeting the end user requirements.
- The safety precautions that are necessary during the use of quick coupling systems to prevent personal injury and property damage.
- Independent technical alterations.

### Safety instructions

Our extensive safety instructions can be found on our website under "Service" or by using the provided QR code.



### Pressure Equipment Directive

The Pressure Equipment Directive 2014/68/EU of the European Union is generally applicable to products with an operating pressure (PS) of more than 0.5 bar. In accordance with the Pressure Equipment Directive, quick couplings can be classified as pressure-maintaining components. In compliance with the Pressure Equipment Directive, WALTHER-PRÄZISION products are compliantly designed and are delivered depending on their further rating with or without a CE marking. Quick couplings from the standard product range are generally designed for Group II media according to the Pressure Equipment Directive. An inspection by WALTHER-PRÄZISION must be requested for use with Group I media.



## Consultation and service



### Do the following issues affect your application?

Then contact us for a non-binding consultation, also available as an on-site service.

- **Coupling/uncoupling under residual pressure**  
Coupling or uncoupling under residual pressure is not only power-intensive and impossible, but can lead to strong reaction forces or the so-called "whip effect". This may also result in damage to the fittings.
- **Pulsating pressures**  
This can lead to deformation of the locking elements and valves, which can render uncoupling no longer possible or restrict the flow.
- **Use of non-lubricating media**  
Solvents, alkalis, and other media can lead to the premature failure of the coupling system, because the O-rings on the components lack their lubricating effect.
- **Temperature-sensitive processes and environments**  
To protect employees, special operating elements should be provided here, as the systems can be especially hot or cold due to the transported medium or the environment.
- **Interface reduction**  
Minimizing the interfaces (adapters) helps reduce the potential for leakages.
- **Special requirements regarding the cleanliness of fittings**  
Sensitive media place special demands on cleanliness levels. Contamination can lead to hazards for the end user or costs associated with reprocessing.
- **Special certifications**  
Certain operating conditions require special certifications. Our range includes many certified products. We would be happy to assist you with special permits.
- **Non-movable head of liquid**  
Incompressible media require system-controlled volume compensation. If this is not available, coupling is not possible.
- **Highly viscous media**  
Media viscosity must be taken into account when calculating nominal diameters.
- **Optimisation of flow rate and nominal fitting diameters**  
Fitting connections should correspond to the nominal diameter of the fitting, at least at their smallest bore diameter.

**To avoid unnecessary costs, get in touch with WALTHER at an early stage.  
We will design your assembly and production process as cost-effectively as possible.**

We would be happy to provide you with support and advice. Please contact us:



+49 (0) 2129 / 567-405



tk@walther-praezision.de



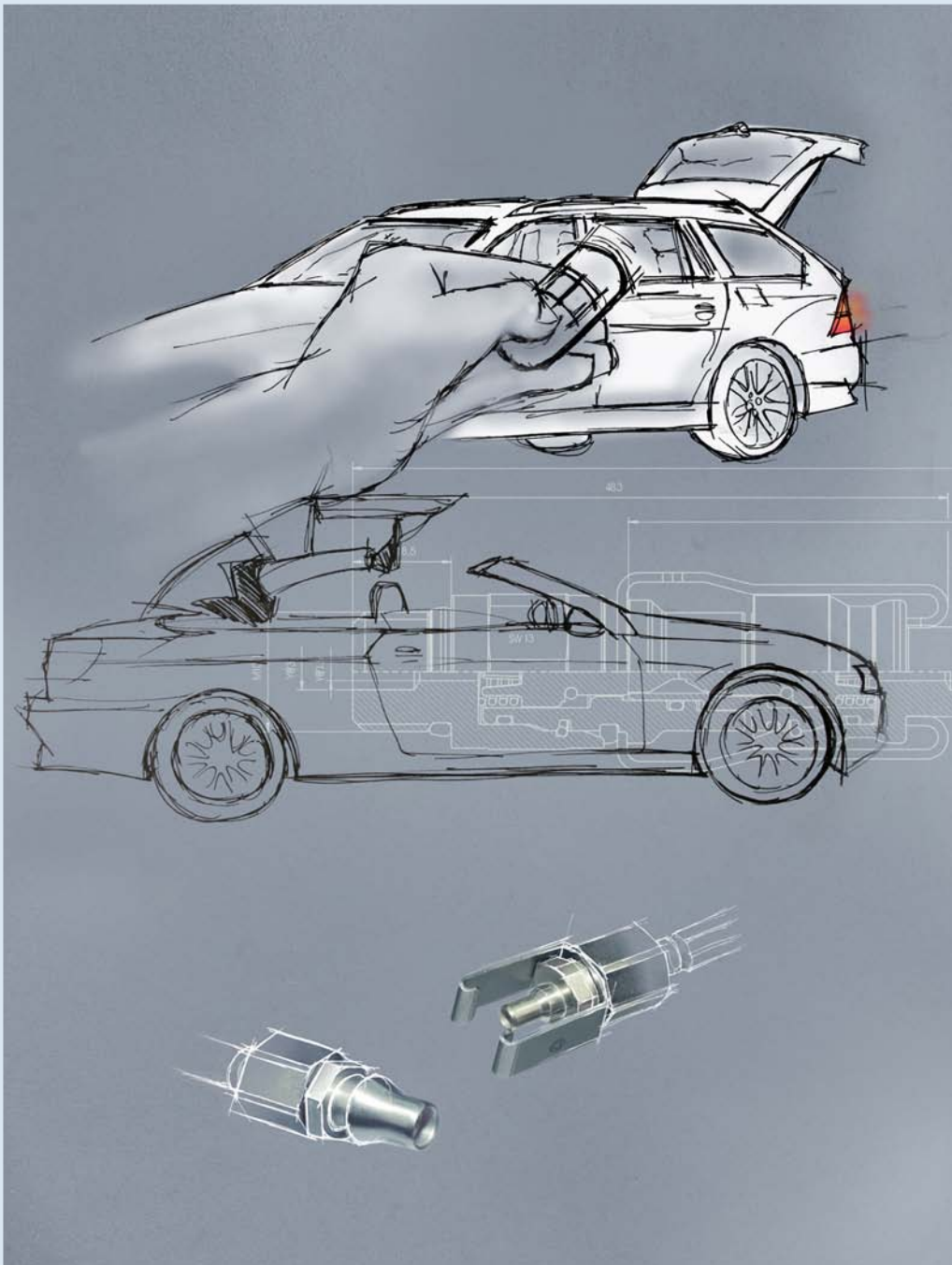



Nominal bores from 2.5 to 3 mm for pressure ranges up to 500 bar are used in different applications: in control lines, test lines and even in the cooling of smaller units. Both unilaterally and bilaterally locking systems, as well as designs without valves, can be used here. Extremely small installation spaces with nonetheless ergonomic handling and a broad spectrum of materials, sealing materials and connection types distinguish our range.



## Mini-couplings up to 500 bar / 2,750 psi

### Types finder

Typical applications	Features + options	Maximum permissible static pressure* [bar / psi]	Standard temperature** [°C]	Type	Page
High-pressure hydraulics	Standard both sides self-sealing (valve in coupling and adaptor)	500 / 7,250	-20 to +200	<b>02-003</b>	27
Water, compressed air	Automatic locking, one side self-sealing (valve only on coupling side)	100 / 1,450	-20 to +80	<b>06-003</b> 	28
Water, compressed air, hydraulics	Automatic locking, both sides self-sealing (valve in coupling and adaptor)	200 / 2,900	-20 to +80	<b>07-003</b> 	29
Water, fuel, compressed air, oils	Automatic locking, one side self-sealing (valve only on coupling side)	100 / 1,450	-20 to +200	<b>LP-003</b>	30

\* The max. permissible static pressure depends on the chosen technical version.

\*\* The suitability for temperature depends on the medium, operating pressure and the quick coupling materials used.

We would be happy to provide you with support and advice. Please contact us:



+49 (0) 2129 / 567-405



tk@walther-praezision.de







## Types 02-003 | 06-003 | 07-003 | LP-003

### Technical chart | Mini-couplings

Nominal bore [mm]	Cv value		Q [L/min] water 20 °C, Δp = 1 bar		Q [m³/h] air 6 bar, 20 °C, Δp = 1 bar		p max. permissible static [bar / psi]			Type
	EA	BA	EA	BA	EA	BA	Steel	Brass	Stainless steel	
							coupled			
2.5		0.10		1.43		5.06	500 / 7,250			02-003
2.5	0.17		2.43		8.60		100 / 1,450			06-003
3		0.14		2.00		7.08	200 / 2,900			07-003
3	0.21		3.00		10.63		200 / 2,900			LP-003

One side self-sealing (EA). Both sides self-sealing (BA). The pressure values are applicable at a temperature of 20°C. Please inquire about other temperature ranges.

Stated maximum permissible operating pressures (p max. permissible static) only apply to materials specified by us and to operation with group II media according to directive 2014/68/EU. Material combinations, optional materials, as well as other media or other temperature ranges can lead to divergent maximum permissible operating pressures and must be requested separately.

Please note that the maximum permissible operating pressure of the connection and quick coupling system must be considered when determining the operating pressure. Our safety instructions must be followed.

◀◀ The **performance diagram** can be found on the front catalogue fold-out page.

A detailed **connection description** can be found on the back catalogue fold-out page. ▶▶

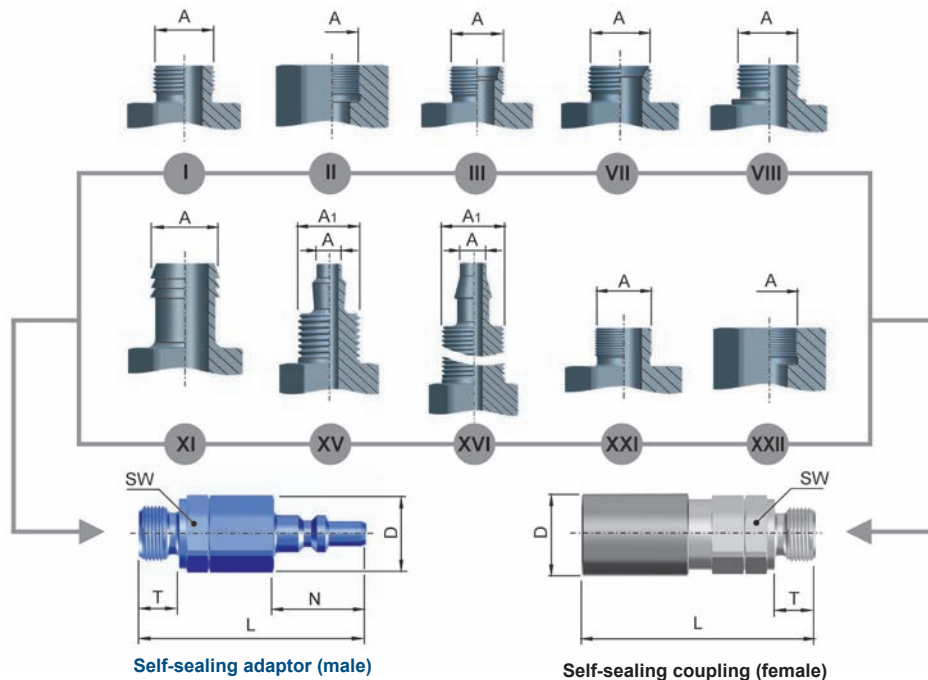



## Type 02-003

### Features chart | Mini-couplings

	Product features	Materials	Seals	Additional options
Standard	- Only usable with both sides self-sealing or without valve	12 = Steel oil burnished	1 = NBR 2 = FKM	OV* = Without valve More on request (see pages 19-20)
Optional		13 = Steel chemically nickel plated	4 = EPDM	

\*Both sides only

Suitable hose lines with coupling fittings can be found in the section Accessories under „Reinforced hose lines“ (95021-0, 95020-0, 95020-2)

**Attention:** Self-sealing coupling + OV  $\triangleq$  Product type Thru-type coupling; Self-sealing adaptor + OV  $\triangleq$  Product type Thru-type adaptor

For example, a complete part number looks like this:

**02-003-0-L0612-Material-Seal-Additional options-Y./-Z..**



### Product chart | Mini-couplings

Self-sealing adaptor marked in blue

NB	Product type	A	Design	Range	Pipe AD	Pipe ID	SW	T	D	L	N	Weight Steel	Material-neutral part number
2.5	Self-sealing coupling (female)	M 12 x 1.5	III	L	6	4	14	10	16.2	46.5		42	02-003-0-L0612-...-
2.5	Self-sealing coupling (female)	BSPP 1/4"	VII				14	11.5	16.2	47.5		45	02-003-0-VR013-...-
2.5	Self-sealing coupling (female)	BSPP 1/8"	VIII				14	9.5	16.2	46		42	02-003-0-WB010-...-
2.5	Self-sealing adaptor (male)	M 12 x 1.5	III	L	6	4	14	10	16.2	46	18.5	30	02-003-2-L0612-...-
2.5	Self-sealing adaptor (male)	BSPP 1/4"	VII				14	11	16.2	47	18.5	33	02-003-2-VR013-...-
2.5	Self-sealing adaptor (male)	BSPP 1/8"	VIII				14	9.5	16.2	45.5	18.5	30	02-003-2-WB010-...-

NB - Nominal bore [mm] A - Connection SW - Wrench size [mm] T - Thread length [mm] D - Diameter [mm] L - Length [mm] N - Adaptor length [mm] Weight [g]



## Type 06-003



### Features chart | Mini-couplings

	Product features	Materials	Seals	Additional options
Standard	- Automatic locking (one-hand operation)	23 = Brass nickel plated	1 = NBR 2 = FKM 4 = EPDM	OV* = Without valve
Optional				

\*No automatic locking is omitted here

**Attention:** Self-sealing coupling + OV  $\triangleq$  Product type Thru-type coupling; Self-sealing adaptor + OV  $\triangleq$  Product type Thru-type adaptor

For example, a complete part number looks like this:

**06-003-0-SL004-Material-Seal-Additional options-Y..-Z..**

### Product chart | Mini-couplings

Thru-type adaptor marked in blue



NB	Product type	A / A1	Design	Pipe ID	SW	T	D	L	N	Weight Brass	Material-neutral part number
2.5	Self-sealing coupling (female)	4 mm	XI	2	9	19	10	39.5		10	06-003-0-SL004-...
2.5	Self-sealing coupling (female)	OD 6 ID 4 mm M 10 x 1	XV		11	16	10	36.5		21	06-003-0-SW004-...
2.5	Self-sealing coupling (female)	M 5	XXI		9	6	10	26.5		8	06-003-0-XX001-...
2.5	Self-sealing coupling (female)	OD 6 ID 4 mm M 10 x 1	XVI		11	25	10	45.5		25	06-003-0-XX006-...
2.5	Self-sealing coupling (female)	M 10	XXI		11	10	10	30.5		12	06-003-0-XX010-...
2.5	Self-sealing coupling (female)	M 5	XXII		9	7	10	28		11	06-003-0-XX015-...
2.5	Thru-type adaptor (male)	4 mm	XI			19	6	29.5	9	3	06-003-1-SL004-..
2.5	Thru-type adaptor (male)	OD 6 ID 4 mm M 10 x 1	XV		11	16	12	29	9	17	06-003-1-SW004-..
2.5	Thru-type adaptor (male)	BSPP 1/8"	I		11	8	12	21	9	6	06-003-1-WR010-..
2.5	Thru-type adaptor (male)	M 5	XXI		9	6	9.9	19	9	4	06-003-1-XX001-..
2.5	Thru-type adaptor (male)	M 5	XXII		9	7	9.9	18	9	5	06-003-1-XX015-..

NB - Nominal bore [mm] A / A1 - Connection SW - Wrench size [mm] T - Thread length [mm] D - Diameter [mm] L - Length [mm] N - Adaptor length [mm] Weight [g]



## Features chart | Mini-couplings

	Product features	Materials	Seals	Additional options
Standard	- Automatic locking (one-hand operation)	23 = Brass nickel plated	1 = NBR 2 = FKM 4 = EPDM	On request (see pages 19-20)
Optional		01 = Stainless steel 1.4404/1.4571 or similar		

**Attention:** Self-sealing coupling + OV  $\triangleq$  Product type Thru-type coupling; Self-sealing adaptor + OV  $\triangleq$  Product type Thru-type adaptor

For example, a complete part number looks like this:

**07-003-0-SL004-Material-Seal-Additional options-Y./-Z..**

## Product chart | Mini-couplings

Self-sealing adaptor marked in blue



NB	Product type	A / A1	Design	SW	T	D	L	N	Weight Brass	Material-neutral part number
3	Self-sealing coupling (female)	4 mm	XI	12	19	15	51.8		32	07-003-0-SL004-...-
3	Self-sealing coupling (female)	OD 6 ID 4 mm M 10 x 1	XV	12	16	15	47.8		41	07-003-0-SW004-...-
3	Self-sealing coupling (female)	BSPP 1/8"	I	12	8	15	39.8		32	07-003-0-WR010-...-
3	Self-sealing coupling (female)	BSPP 1/8"	II	12	9	15	37.8		30	07-003-0-WR510-...-
3	Self-sealing adaptor (male)	4 mm	XI	12	19	13.2	50	15	17	07-003-2-SL004-...-
3	Self-sealing adaptor (male)	OD 6 ID 4 mm M 10 x 1	XV	12	16	13.2	46	15	27	07-003-2-SW004-...-
3	Self-sealing adaptor (male)	BSPP 1/8"	I	12	8	13.2	38	15	18	07-003-2-WR010-...-
3	Self-sealing adaptor (male)	BSPP 1/8"	II	12	9	13.2	36	15	15	07-003-2-WR510-...-

NB - Nominal bore [mm] A / A1 - Connection SW - Wrench size [mm] T - Thread length [mm] D - Diameter [mm] L - Length [mm] N - Adaptor length [mm] Weight [g]



## Type LP-003

### Features chart | Mini-couplings

	Product features	Materials	Seals	Additional options
Standard	- Automatic locking (one-hand operation)	23 = Brass nickel plated	1 = NBR 2 = FKM 4 = EPDM	OV = Without valve
Optional				

**Attention:** Self-sealing coupling + OV  $\triangleq$  Product type Thru-type coupling

For example, a complete part number looks like this:

**LP-003-0-L0612-Material-Seal-Additional options-Y..-Z..**

### Product chart | Mini couplings

Thru-type adaptor marked in blue



NB	Product type	A / A1	Design	Range	Pipe AD	Pipe ID	SW	T	D	L	N	Weight Brass	Material-neutral part number
3	Self-sealing coupling (female)	M 12 x 1.5	III	L	6	4	14	10	15	34.5		38	LP-003-0-L0612-...-
3	Self-sealing coupling (female)	4 mm	XI			2.5	14	19	15	44.5		36	LP-003-0-SL004-...-
3	Self-sealing coupling (female)	OD 6 ID 4 mm M 10 x 1	XV				14	16	15	40.5		50	LP-003-0-SW004-...-
3	Self-sealing coupling (female)	BSPP 1/8"	I				14	8	15	32.5		32	LP-003-0-WR010-...-
3	Thru-type adaptor (male)	4 mm	XI					19	8	35	13	4	LP-003-1-SL004-..
3	Thru-type adaptor (male)	OD 6 ID 4 mm M 10 x 1	XV				12	16	13.2	33	13	17	LP-003-1-SW004-..
3	Thru-type adaptor (male)	BSPP 1/8"	I				12	8	13.8	25	13	9	LP-003-1-WR010-..

NB - Nominal bore [mm] A / A1 - Connection SW - Wrench size [mm] T - Thread length [mm] D - Diameter [mm] L - Length [mm] N - Adaptor length [mm] Weight [g]





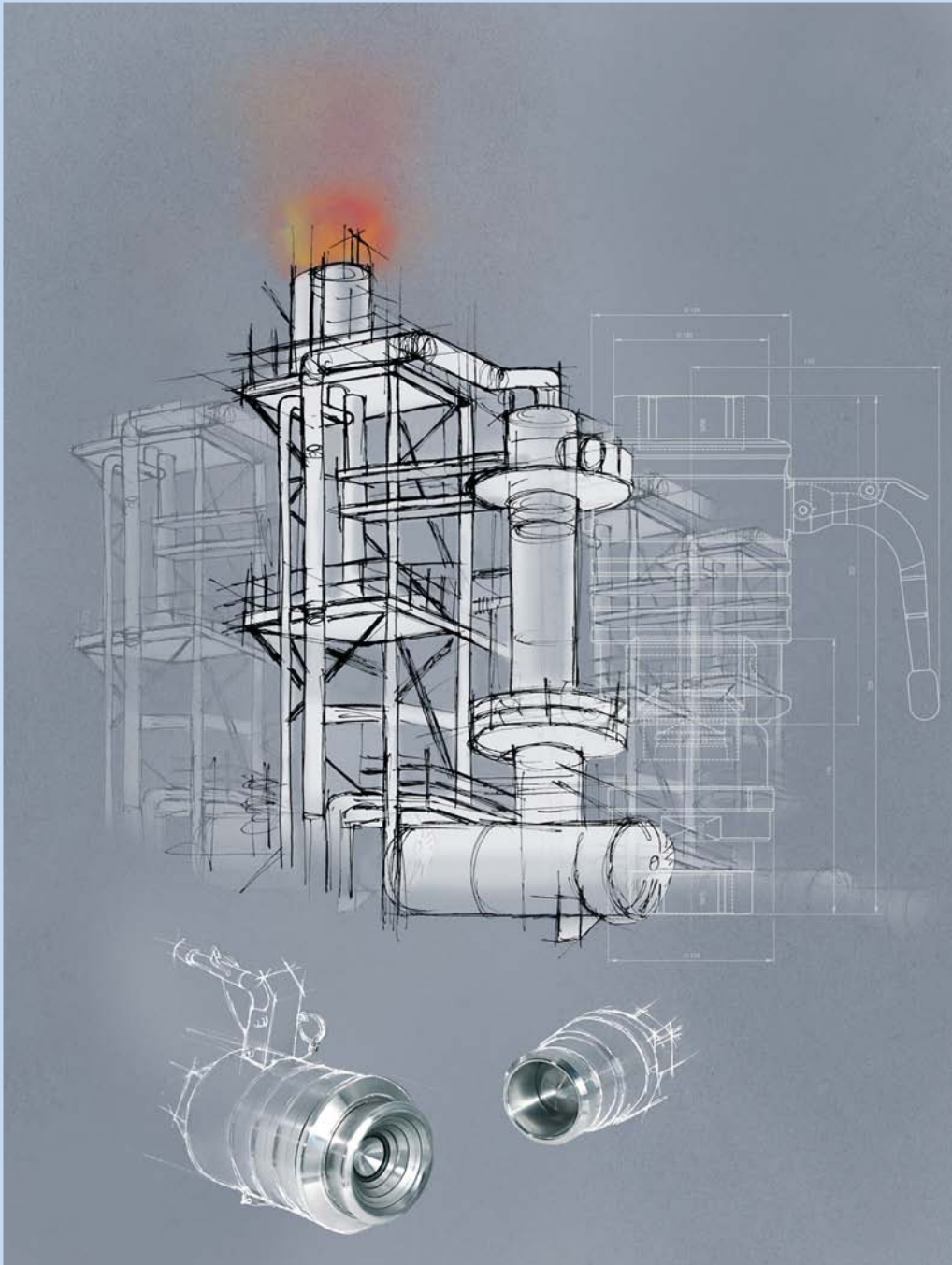

In low pressure ranges, quick couplings are used in the supply of compressed air, gas applications, cooling and temperature control circuits, hydraulic systems, as well as the supply lines of chemical acids and alkalis. You will find WALTHER coupling systems wherever quality comes into play, or where fluidic systems need to be connected and disconnected frequently and safely. To this end, different materials, sealing materials and valve systems (even in clean break designs) are installed - to the greatest customer advantage.





## Quick coupling systems up to 110 bar / 1,600 psi

### Series Finder

Clean break valve designs marked in green

Typical applications	Features + options	Maximum permissible static pressure* [bar / psi]	Standard temperature** [°C]	Series	Page
Heat transfer oil	High-temperature coupling, heat-proof handles, automatic locking	16 / 232	to +310	<b>11</b>	34
Chemistry safety sector	ATEX-, FDA- and TA-Luft compliant, ball face, automatic locking	64 / 928	-10 to +200	<b>BF</b>	36
Cooling water - Railway technology	Vibration resistance, easy to install	16 / 232	-50 to +85	<b>CG</b>	40
Cooling water, liquid media	Plastic version	16 / 232	-15 to +70	<b>CK</b>	44
Hose lines - Chemistry	Suitable for vacuums, can be coupled against residual pressures	25 / 363	-15 to +200	<b>CN</b>	46
Process and laboratory technology	ATEX- and TA-Luft compliant	64 / 928	-15 to +200	<b>CT</b>	50
For pastes and powders	Screw type coupling	50 / 725	-70 to +250	<b>EH</b>	60
Water, fuel, technical gases, mildly aggressive media	Plastic version	12 / 174	0 to +80	<b>KL</b>	64
Water, fuel, compressed air, oils	No squirt effects at NB 6 to 19, ring grips from NB 32	110 / 1,595	-30 to +200	<b>LP</b>	70
Mains-side compressed air safety	Backlash-free during disconnection, can also be coupled with EURO adaptor DIN 14152	16 / 232	-20 to +80	<b>LS</b>	84
Tool-side compressed air safety	Can also be coupled with EURO adaptor DIN 14152	12 / 174	-20 to +80	<b>LT</b>	88
Water, fuel, compressed air, oils, chemistry, medical technology	No squirting effect	60 / 870	-30 to +200	<b>LV</b>	92
Water, fuel, oils, compressed air, gases, hydraulics	Compact dimensions	100 / 1,450	-30 to +200	<b>SP</b>	96
Gaseous/liquid media	Non-interchangeable keys, mechanical coding	40 / 580	-30 to +200	<b>UF</b>	102
Laboratory, medical and nuclear installations with gas, liquid or vacuum lines	Non-interchangeable round keys, suitable for manipulator operation, mechanical coding	20 / 290	-30 to +200	<b>UM</b>	108

\* The max. permissible static pressure depends on the chosen technical version.

\*\* The suitability for temperature depends on the medium, operating pressure and the quick coupling materials used.

We would be happy to provide you with support and advice. Please contact us:



+49 (0) 2129 / 567-405



tk@walther-praezision.de





# Series 11



## Technical chart | Quick coupling systems

Nominal bore [mm]	Cv value		Q [L/min] oil (6,1 mm <sup>2</sup> /s; 900 kg/m <sup>3</sup> ) 20 °C, Δp = 1 bar		p max. permissible static [bar / psi]
	EA	BA	EA	BA	
12		3.23		44.42	16 / 232
19		6.29		88.25	16 / 232

One side self-sealing (EA). Both sides self-sealing (BA). The pressure values are applicable at a temperature of 20°C. Please inquire about other temperature ranges.

Stated maximum permissible operating pressures (p max. permissible static) only apply to materials specified by us and to operation with group II media according to directive 2014/68/EU. Material combinations, optional materials, as well as other media or other temperature ranges can lead to divergent maximum permissible operating pressures and must be requested separately.

Please note that the maximum permissible operating pressure of the connection and quick coupling system must be considered when determining the operating pressure. Our safety instructions must be followed.

◀◀ The **performance diagram** can be found on the front catalogue fold-out page.

A detailed **connection description** can be found on the back catalogue fold-out page. ▶▶

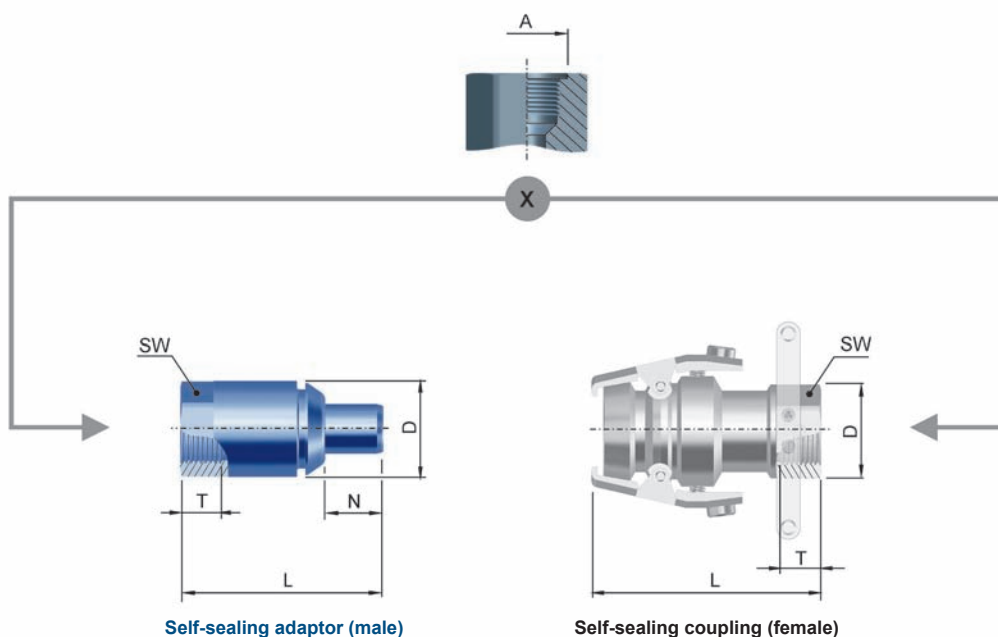



## Features chart | Quick coupling systems

	Product features	WEDISO	Additional options
Standard	- Non-squirting automatic locking (one-hand operation)	<b>Self-sealing coupling</b> AAAH: up to max. 270°C AAAG (11-012)/AAAI (11-019): up to max. 310°C, oil-burnished steel, HT-GRA sealing combinations	HG* = Heat-proof handles (11-012-0 and 11-019-0)
Optional		<b>self-sealing adaptor</b> AAAA: up to max. 310°C, oil-burnished steel, HT-GRA sealing combinations	
		Other materials on request	

\*11-012-0: Overall width = 110 mm, width without handles 54 mm 11-019-0: Overall width = 110 mm, width without handles 61.4 mm

**Note:** Connection A is suitable for threaded ends type A, B, E according to DIN 3852-T2 (optional sealing with metal sealing rings DIN 7603 or sealing edge)

For example, a complete part number looks like this:

**11-012-0-WR526-WEDISO-Additional options-Y../-Z..**

## Product chart | Quick coupling systems

Self-sealing adaptor marked in blue



NB	Product type	A	Design	SW	T	D	L	N	Weight Steel	Material-neutral part number
12	Self-sealing coupling (female)	BSPP 3/4"	X	36	16	42	100.4		625	11-012-0-WR526-....
12	Self-sealing adaptor (male)	BSPP 3/4"	X	34	16	37.5	95	23	292	11-012-2-WR526-....
19	Self-sealing coupling (female)	BSPP 1"	X	41	18	46	112.4		1,047	11-019-0-WR533-....
19	Self-sealing adaptor (male)	BSPP 1"	X	41	18	46	97.5	28	533	11-019-2-WR533-....

NB - Nominal bore [mm] A - Connection SW - Wrench size [mm] T - Thread length [mm] D - Diameter [mm] L - Length [mm] N - Adaptor length [mm] Weight [g]



## Series BF

### Technical chart | Quick coupling systems

Nominal bore [mm]	Cv value		Q [L/min] water 20 °C, Δp = 1 bar		Q [m³/h] air 6 bar, 20 °C, Δp = 1 bar		p max. permissible static [bar / psi]
	EA	BA	EA	BA	EA	BA	
							Stainless Steel coupled
5		0.80		11.42		40.49	64 / 928
9		4.00		57.12		202.43	64 / 928
12		8.00		114.25		404.85	64 / 928
25		14.70		209.93		743.92	40 / 580
50		59.50		849.72		3,011.11	16 / 232

One side self-sealing (EA). Both sides self-sealing (BA). The pressure values are applicable at a temperature of 20°C. Please inquire about other temperature ranges.

Stated maximum permissible operating pressures (p max. permissible static) only apply to materials specified by us and to operation with group II media according to directive 2014/68/EU. Material combinations, optional materials, as well as other media or other temperature ranges can lead to divergent maximum permissible operating pressures and must be requested separately.

Please note that the maximum permissible operating pressure of the connection and quick coupling system must be considered when determining the operating pressure. Our safety instructions must be followed.

◀◀ The **performance diagram** can be found on the front catalogue fold-out page.

A detailed **connection description** can be found on the back catalogue fold-out page. ▶▶

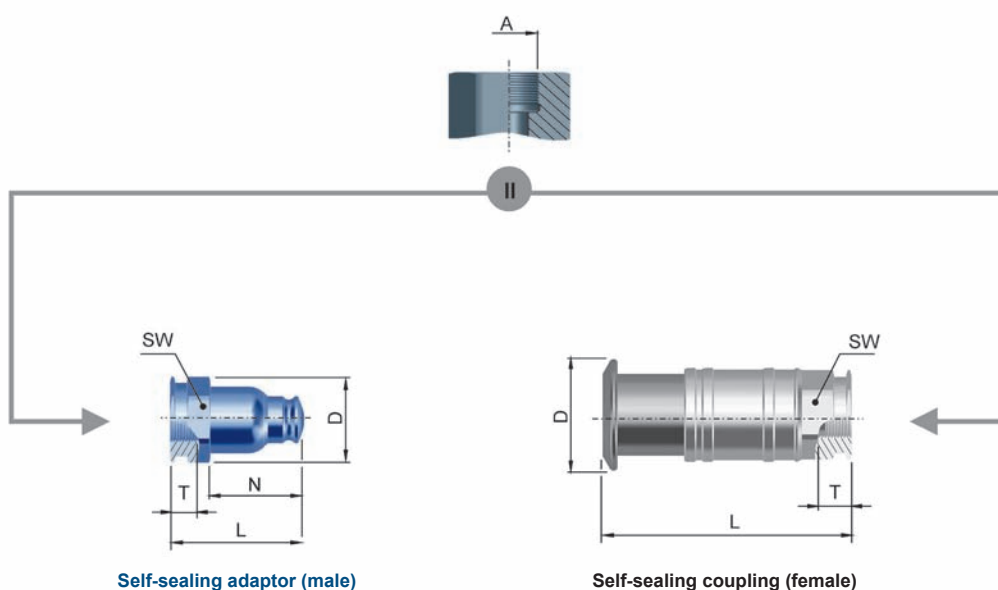





## Series BF

### Features chart | Quick coupling systems

	Product features	Materials	Seals	Additional options
Standard	<ul style="list-style-type: none"> <li>- Low leakage volume during disconnection</li> <li>- Automatic locking (one-hand operation)</li> <li>- Connection without air inclusion</li> <li>- Easy cleaning</li> </ul>	01 = Stainless steel 1.4404/1.4571 or similar	2 = FKM 4 = EPDM	BB = 3.1 production EF = 1935/2004-compliant EX = ATEX-compliant FD = FDA-compliant FF = Oil- and grease-free FL = Free from enamel flow-disturbing substances TA = Certified by the Clean Air Act (TA-Luft)
Optional			FFKM	

**Note:** Residual leakage quantities or coupling ingress volumes on request.

For example, a complete part number looks like this:  
**BF-005-0-WR513-Material-Seal-Additional options-Y./-Z..**

### Product chart | Quick coupling systems

Self-sealing adaptor marked in blue



NB	Product type	A	Design	SW	T	D	L	N	Weight Stainless steel	Material-neutral part number
5	Self-sealing coupling (female)	BSPP 1/4"	II	22	13	29	68.5		165	BF-005-0-WR513-...-
5	Self-sealing adaptor (male)	BSPP 1/4"	II	22	13	24.5	37.5	23.5	50	BF-005-2-WR513-...-
9	Self-sealing coupling (female)	BSPP 1/2"	II	32	17	44	122		630	BF-009-0-WR521-...-
9	Self-sealing adaptor (male)	BSPP 1/2"	II	32	17	35.7	68	47.8	190	BF-009-2-WR521-...-

**NB** - Nominal bore [mm]   **A** - Connection   **SW** - Wrench size [mm]   **T** - Thread length [mm]   **D** - Diameter [mm]   **L** - Length [mm]   **N** - Adaptor length [mm]   Weight [g]



## Series BF

### Product chart | Quick coupling systems

Self-sealing adaptor marked in blue

NB	Product type	A	Design	SW	T	D	L	N	Weight Stainless steel	Material-neutral part number
12	Self-sealing coupling (female)	BSPP 3/4"	II	46	19	64	143		1,300	BF-012-0-WR526-...
12	Self-sealing adaptor (male)	BSPP 3/4"	II	46	19	51.2	78	54.2	440	BF-012-2-WR526-...
25	Self-sealing coupling (female)	BSPP 1 1/2"	II	55	25	96	159		4,500	BF-025-0-WR548-...
25	Self-sealing adaptor (male)	BSPP 1"	II	41	31.5	68	131	55.6	1,300	BF-025-2-WR533-...
50	Self-sealing coupling (female)	BSPP 2 1/2"	II	95	33	137	223		15,200	BF-050-0-WR575-...
50	Self-sealing adaptor (male)	BSPP 2"	II	75	35	114	195	80.8	5,350	BF-050-2-WR560-...

NB - Nominal bore [mm]   A - Connection   SW - Wrench size [mm]   T - Thread length [mm]   D - Diameter [mm]   L - Length [mm]   N - Adaptor length [mm]   Weight [g]





## Series CG

### Technical chart | Quick coupling systems

Nominal bore [mm]	Cv value		Q [L/min] water 20 °C, Δp = 1 bar		Q [m³/h] air 6 bar, 20 °C, Δp = 1 bar		p max. permissible static [bar / psi]
	EA	BA	EA	BA	EA	BA	
							Aluminium coupled
6		1.00		14.28		50.61	16 / 232
9		2.70		38.56		136.64	16 / 232
12		4.50		64.26		227.73	16 / 232
16		9.10		129.96		460.52	16 / 232
20		13.00		185.65		657.89	16 / 232
25		18.50		264.20		936.23	16 / 232

One side self-sealing (EA). Both sides self-sealing (BA). The pressure values are applicable at a temperature of 20°C. Please inquire about other temperature ranges.

Stated maximum permissible operating pressures (p max. permissible static) only apply to materials specified by us and to operation with group II media according to directive 2014/68/EU. Material combinations, optional materials, as well as other media or other temperature ranges can lead to divergent maximum permissible operating pressures and must be requested separately.

Please note that the maximum permissible operating pressure of the connection and quick coupling system must be considered when determining the operating pressure. Our safety instructions must be followed.

◀◀ The **performance diagram** can be found on the front catalogue fold-out page.

A detailed **connection description** can be found on the back catalogue fold-out page. ▶▶

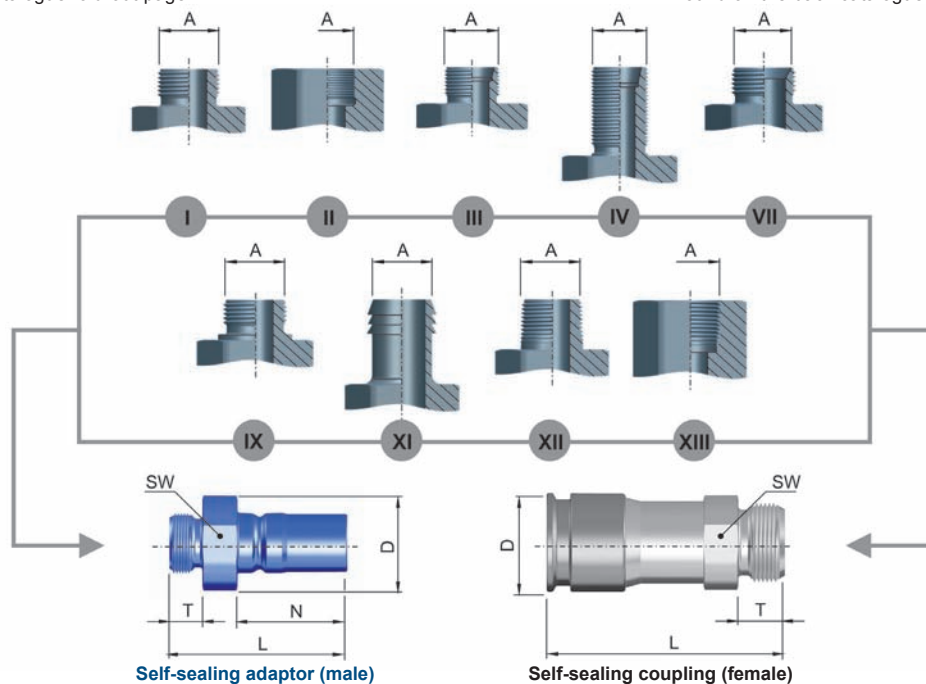



## Series CG

### Features chart | Quick coupling systems

	Product features	WEDISO	Additional options
Standard	<ul style="list-style-type: none"> <li>- Low leakage volume during disconnection</li> <li>- High flow rate</li> <li>- Dirt protection possible while coupled</li> <li>- Vibration resistance to EN61373, Cat. 1</li> <li>- Flange connection or 90° outgoing feeder possible</li> <li>- Available with hose</li> <li>- Airfree connecting</li> </ul>	<b>Material</b> Aluminium <b>Seals</b> FKM, VMQ and FVMQ	On request (see pages 19-20)
Optional		Other materials on request	

The exact material and seal quality must be requested depending on the material-neutral part number.

**Note:** Residual leakage quantities or coupling ingress volumes on request.

For example, a complete part number looks like this:

**CG-G06-0-L1218-WEDISO-Additional options-Y..**



### Product chart | Quick coupling systems

Self-sealing adaptor marked in blue

NB	Product type	A	De-sign	Ran-ge	Pipe AD	Pipe ID	SW	T	D	L	N	Weight Aluminium	Material-neutral part number
6	Self-sealing coupling (female)	M 18 x 1.5	III	L	12	10	19	11	27.5	74.3		84	CG-G06-0-L1218-....-Y01
6	Self-sealing coupling (female)	NPT 1/4"	XIII				19	10.5	27.5	69.3		65	CG-G06-0-NP513-....-Y01
6	Self-sealing coupling (female)	BSPP 1/4"	VII				19	17	27.5	74.3		82	CG-G06-0-VR013-....-Y01
6	Self-sealing coupling (female)	6 mm	XI			4	19	27.3	27.5	95.6		64	CG-G06-0-XX007-....-Y01
6	Self-sealing adaptor (male)	NPT 1/4"	XII				19	17	27.5	70.3	30	91	CG-G06-2-NP013-....-Y01

NB - Nominal bore [mm] A - Connection SW - Wrench size [mm] T - Thread length [mm] D - Diameter [mm] L - Length [mm] N - Adaptor length [mm] Weight [g]





## Series CG

### Product chart | Quick coupling systems

Self-sealing adaptor marked in blue

NB	Product type	A	De- sign	Ran- ge	Pipe AD	Pipe ID	SW	T	D	L	N	Weight Aluminium	Material-neutral part number
6	Self-sealing adaptor (male)	NPT 1/4"	XIII				19	10.5	27.5	60	30	36	CG-G06-2-NP513-.....Y01
6	Self-sealing adaptor (male)	M 18 x 1.5	IV	L	12	8	22	35.5	27.5	86.8	30	102	CG-G06-2-XX005-.....Y01
6	Self-sealing adaptor (male)	BSPP 1/2"	I				30	13	35	63.5	30	92	CG-G06-2-XX006-.....Y01
9	Self-sealing coupling (female)	BSPP 3/8"	VII				30	12	32	77.6		122	CG-G09-0-VR017-.....Y01
9	Self-sealing adaptor (male)	BSPP 3/8"	VII				30	12	32	63.3	33	71	CG-G09-2-VR017-.....Y01
12	Self-sealing coupling (female)	13 mm	XI			9	32	30	36	101		109	CG-G12-0-SL013-.....Y08
12	Self-sealing coupling (female)	16 mm	XI				32	30	36	100		132	CG-G12-0-XX007-.....Y08
12	Self-sealing coupling (female)	BSPP 1/2"	II				32	12	36	81.9		145	CG-G12-0-XX019-.....Y08
12	Self-sealing coupling (female)	BSPP 1/2"	V				32	13	36	86.9		140	CG-G12-0-XX027-.....Y08
12	Self-sealing coupling (female)	M 22 x 1.5	III	L	15	10	32	14	36	84.9		105	CG-G12-0-XX031-.....Y08
12	Self-sealing adaptor (male)	BSPP 1/2"	II				32	12	34.5	64.8	40	65	CG-G12-2-XX019-.....Y08
12	Self-sealing adaptor (male)	BSPP 1/2"	V				32	13	34.5	67.7	40	55	CG-G12-2-XX027-.....Y08
12	Self-sealing adaptor (male)	M 22 x 1.5	III	L	15	10	32	14	34.5	67.6	40	57	CG-G12-2-XX031-.....Y08
16	Self-sealing coupling (female)	BSPP 3/4"	VII				36	16	42	96.1		198	CG-G16-0-VR026-.....Y05
16	Self-sealing coupling (female)	BSPP 3/4"	II				36	16	42	84.9		233	CG-G16-0-XX004-.....Y05
16	Self-sealing coupling (female)	BSPP 1"	II				36	18	42	87.7		224	CG-G16-0-XX005-.....Y05
16	Self-sealing adaptor (male)	BSPP 3/4"	VII				36	16	42	77	34	120	CG-G16-2-VR026-.....Y05
16	Self-sealing adaptor (male)	BSPP 3/4"	II				36	16	42	74.7	34	154	CG-G16-2-XX004-.....Y05
16	Self-sealing adaptor (male)	BSPP 1"	II				36	18	42	77.5	34	146	CG-G16-2-XX005-.....Y05

NB - Nominal bore [mm] A - Connection SW - Wrench size [mm] T - Thread length [mm] D - Diameter [mm] L - Length [mm] N - Adaptor length [mm] Weight [g]





## Series CG

### Product chart | Quick coupling systems

Self-sealing adaptor marked in blue

NB	Product type	A	De- sign	Ran- ge	Pipe AD	Pipe ID	SW	T	D	L	N	Weight Aluminium	Material-neutral part number
20	Self-sealing coupling (female)	M 36 x 2	III	L	28	24	50	14	59	115.7		434	CG-G20-0-L2836-.....-Y01
20	Self-sealing coupling (female)	BSPP 1 1/4"	I				50	22	59	122.7		453	CG-G20-0-WR042- .....-Y01
20	Self-sealing adaptor (male)	M 36 x 2	III	L	28	24	50	14	59	83.4	47	231	CG-G20-2-L2836-.....-Y01
20	Self-sealing adaptor (male)	BSPP 1 1/4"	I				50	22	59	91.4	47	268	CG-G20-2-WR042- .....-Y01
25	Self-sealing coupling (female)	M 36 x 2	III	L	28	24	55	14	62	130.7		488	CG-G25-0-L2836-.....-Y01
25	Self-sealing coupling (female)	BSPP 1 1/4"	IX				55	20	62	139.7		527	CG-G25-0-WE042- .....-Y01
25	Self-sealing adaptor (male)	M 36 x 2	III	L	28	24	55	14	62	90.9	48	255	CG-G25-2-L2836-.....-Y01
25	Self-sealing adaptor (male)	BSPP 1 1/4"	IX				55	20	62	99.9	48	294	CG-G25-2-WE042- .....-Y01

NB - Nominal bore [mm] A - Connection SW - Wrench size [mm] T - Thread length [mm] D - Diameter [mm] L - Length [mm] N - Adaptor length [mm] Weight [g]



## Series CK

### Technical chart | Quick coupling systems

Nominal bore [mm]	Cv value		Q [L/min] water 20 °C, Δp = 1 bar		Q [m³/h] air 6 bar, 20 °C, Δp = 1 bar		p max. permissible static [bar / psi]
	EA	BA	EA	BA	EA	BA	
9		2		28.56		101.21	PVDF coupled 16 / 232

One side self-sealing (EA). Both sides self-sealing (BA). The pressure values are applicable at a temperature of 20°C. Please inquire about other temperature ranges.

Stated maximum permissible operating pressures (p max. permissible static) only apply to materials specified by us and to operation with group II media according to directive 2014/68/EU. Material combinations, optional materials, as well as other media or other temperature ranges can lead to divergent maximum permissible operating pressures and must be requested separately.

Please note that the maximum permissible operating pressure of the connection and quick coupling system must be considered when determining the operating pressure. Our safety instructions must be followed.

◀◀ The **performance diagram** can be found on the front catalogue fold-out page.

A detailed **connection description** can be found on the back catalogue fold-out page. ▶▶

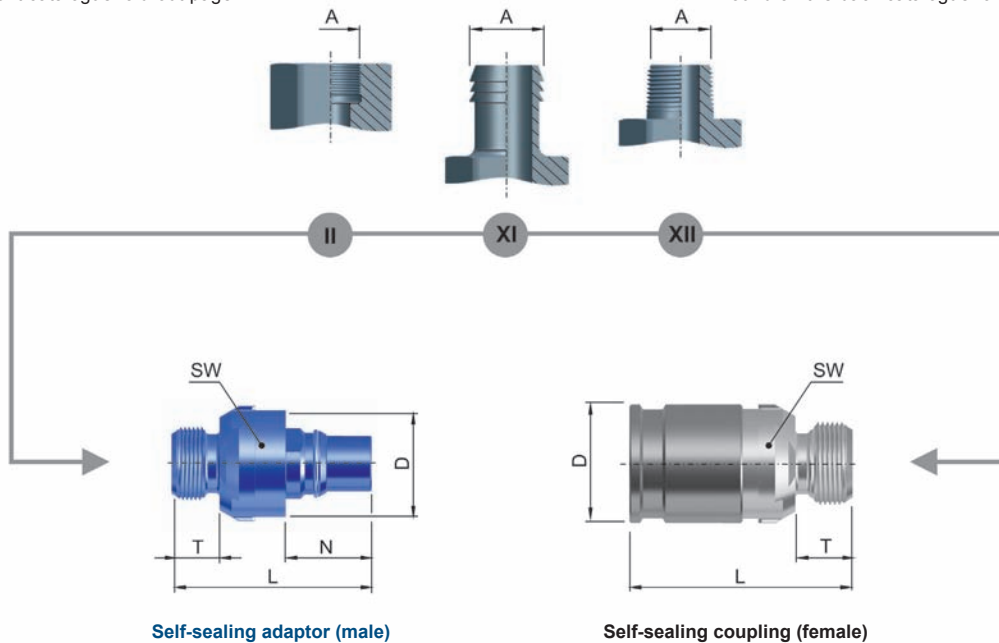



## Series CK

### Features chart | Quick coupling systems

	Product features	Materials	Seals	Additional options
Standard	<ul style="list-style-type: none"> <li>- Low leakage volume during disconnection</li> <li>- With axial safety lock using a pin safety device</li> <li>- Airfree connection</li> </ul>	PV = PVDF / Polyvinylidenfluorid	3 = FKM 4 = EPDM	ST = With pin safety device
Optional			FFKM	More on request (see pages 19-20)

**Note:** The additional feature ST (pin safety device) is an integral component of the part number for the self-sealing coupling and must be specified!

**Attention:** Please note that there is a residual leakage of approx. 0.1 ml during disconnection.

For example, a complete part number looks like this:

**CK-G09-0-NP017-Material-Seal-Additional options-Z02**



### Product chart | Quick coupling systems

Self-sealing adaptor marked in blue

NB	Product type	A	De-sign	Pipe ID	SW	T	D	L	N	Weight PVDF	Material-neutral part number
9	Self-sealing coupling (female)	3/8"	XII		28	17.5	36	67.4		119	CK-G09-0-NP017-...-ST-Z02
9	Self-sealing coupling (female)	BSPP 1/2"	II		30	16	36	67.4		125	CK-G09-0-WR521-...-ST-Z02
9	Self-sealing coupling (female)	9.5 mm	XI	7	28	25	36	75		117	CK-G09-0-XX002-...-ST-Z02
9	Self-sealing adaptor (male)	3/8"	XII		28	17.5	36	65	26.9	38	CK-G09-2-NP017-...-Z02
9	Self-sealing adaptor (male)	BSPP 1/2"	II		30	16	36	64.9	26.9	44	CK-G09-2-WR521-...-Z02
9	Self-sealing adaptor (male)	9.5 mm	XI	7	28	25	36	72.5	26.9	36	CK-G09-2-XX002-...-Z02

NB - Nominal bore [mm] A - Connection SW - Wrench size [mm] T - Thread length [mm] D - Diameter [mm] L - Length [mm] N - Adaptor length [mm] Weight [g]



# Series CN

## Technical chart | Quick coupling systems

Nominal bore [mm]	Cv-Wert		Q [L/min] water 20 °C, Δp = 1 bar		Q [m³/h] air 6 bar, 20 °C, Δp = 1 bar		p max. permissible static [bar / psi]
	EA	BA	EA	BA	EA	BA	
							Stainless steel coupled
25		14		199.93		708.50	25 / 363
40		38		556.96		1,973.67	25 / 363
50		75		1,071.08		3,795.51	25 / 363
80		101		1,442.39		5,111.29	16 / 232
100		120		1,713.73		6,072.82	10 / 145

One side self-sealing (EA). Both sides self-sealing (BA). The pressure values are applicable at a temperature of 20°C. Please inquire about other temperature ranges.

Stated maximum permissible operating pressures (p max. permissible static) only apply to materials specified by us and to operation with group II media according to directive 2014/68/EU. Material combinations, optional materials, as well as other media or other temperature ranges can lead to divergent maximum permissible operating pressures and must be requested separately.

Please note that the maximum permissible operating pressure of the connection and quick coupling system must be considered when determining the operating pressure. Our safety instructions must be followed.

◀◀ The **performance diagram** can be found on the front catalogue fold-out page.

A detailed **connection description** can be found on the back catalogue fold-out page. ▶▶

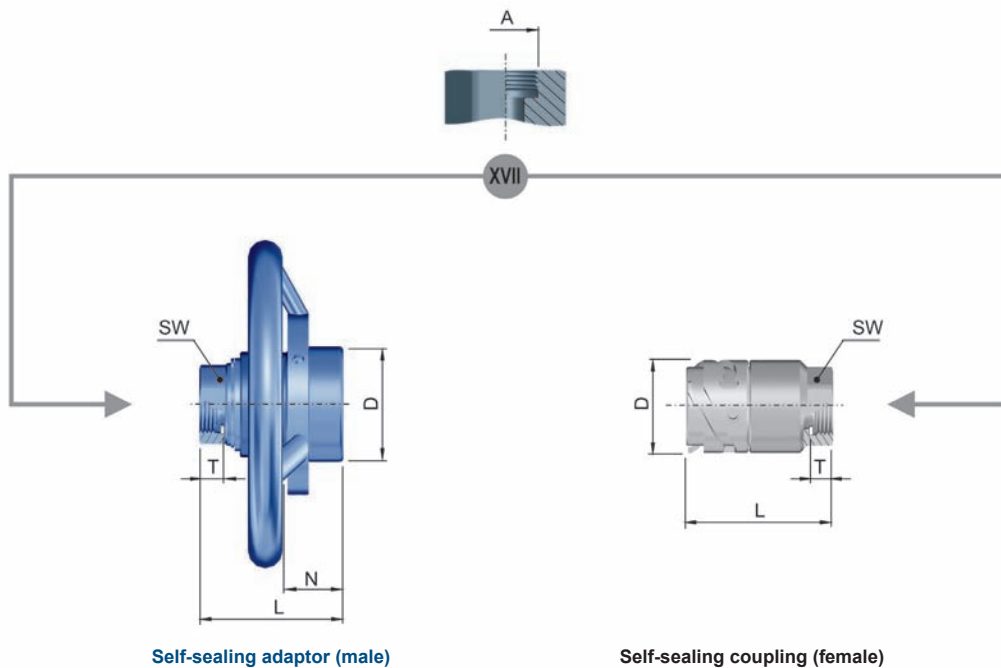



**Features chart | Quick coupling systems**

	Product features	WEDISO	Additional options
Standard	<ul style="list-style-type: none"> <li>- Low leakage volume during disconnection/connection</li> <li>- Bayonet locking</li> <li>- Non-squirting</li> <li>- Can be coupled under residual pressure</li> </ul>	<b>Material</b> 0A = Stainless steel 1.4571 <b>Seals</b> FKM, EPDM	BB = 3.1 production EF = 1935/2004-compliant EG = Ring grips EX = ATEX-compliant FD = FDA-compliant FL = Free from enamel flow-disturbing substances GG* = Ring grips RG* = Ring grips TA = Clean Air Act (TA-Luft)-compliant
Optional	<ul style="list-style-type: none"> <li>- Vacuum-suited (while coupled)</li> <li>- Compact design</li> </ul>	FFKM and other materials on request	

\*Diameter of the ring grips of the self-sealing adaptors: NB 25 = 190 mm, NB 40 = 190 mm, NB 50 = 2210 mm, NB 80 = 265 mm, NB 100 = 300 mm

**Additionally available:** protective caps and plugs, electronic interrogation of the closed state, mechanical coding, lockable against unauthorized access  
**Note:** The additional feature GG and RG is an integral component of the part number for the self-sealing adaptor (exception CN-025) and must be specified!  
 From NB 80 only RG is possible  
**Recommendation:** For handling reasons, the self-sealing couplings should be firmly fixed to the plant, while the self-sealing adaptors (with the ring grips) must be installed in flexible lines!

**Note:** Residual leakage quantities or coupling ingress volumes on request.

For example, a complete part number looks like this:

**CN025-0-WS533-WEDISO-GG/RG-Additional options-Y./-Z..**



**Product chart | Quick coupling systems**

Self-sealing adaptor marked in blue

NB	Product type	A	Design	SW	T	D	L	N	Weight Stainless steel	Material-neutral part number
25	Self-sealing coupling (female)	BSPP 1"	XVII	41	14	54	79		740	CN-025-0-WS533-....
25	Self-sealing adaptor (male)	BSPP 1"	XVII	41	14	66	83	27	880	CN-025-2-WS533-....

NB - Nominal bore [mm] A - Connection SW - Wrench size [mm] T - Thread length [mm] D - Diameter [mm] L - Length [mm] N - Adaptor length [mm] Weight [g]



## Series CN

### Product chart | Quick coupling systems

Self-sealing adaptor marked in blue

NB	Product type	A	Design	SW	T	D	L	N	Weight Stainless steel	Material-neutral part number
40	Self-sealing coupling (female)	BSPP 1 1/2"	XVII	60	18	85	115.8		2,170	CN-040-0-WS548-....
40	Self-sealing adaptor (male)	BSPP 1 1/2"	XVII	60	18	106	124.3	43	3,660	CN-040-2-WS548-....
50	Self-sealing coupling (female)	BSPP 2"	XVII	70	20	94	124		2,570	CN-050-0-WS560-....
50	Self-sealing adaptor (male)	BSPP 2"	XVII	70	20	110	133	45	4,410	CN-050-2-WS560-....
80	Self-sealing coupling (female)	BSPP 3"	XVII	100	24	124	143		5,970	CN-080-0-WS588-....
80	Self-sealing adaptor (male)	BSPP 3"	XVII	100	24	144	148	50	7,320	CN-080-2-WS588-....
100	Self-sealing coupling (female)	BSPP 4"	XVII	120	25	144	164		7,960	CN-100-0-WS613-....
100	Self-sealing adaptor (male)	BSPP 4"	XVII	120	25	164	165	58	9,680	CN-100-2-WS613-....

NB - Nominal bore [mm] A - Connection SW - Wrench size [mm] T - Thread length [mm] D - Diameter [mm] L - Length [mm] N - Adaptor length [mm] Weight [g]



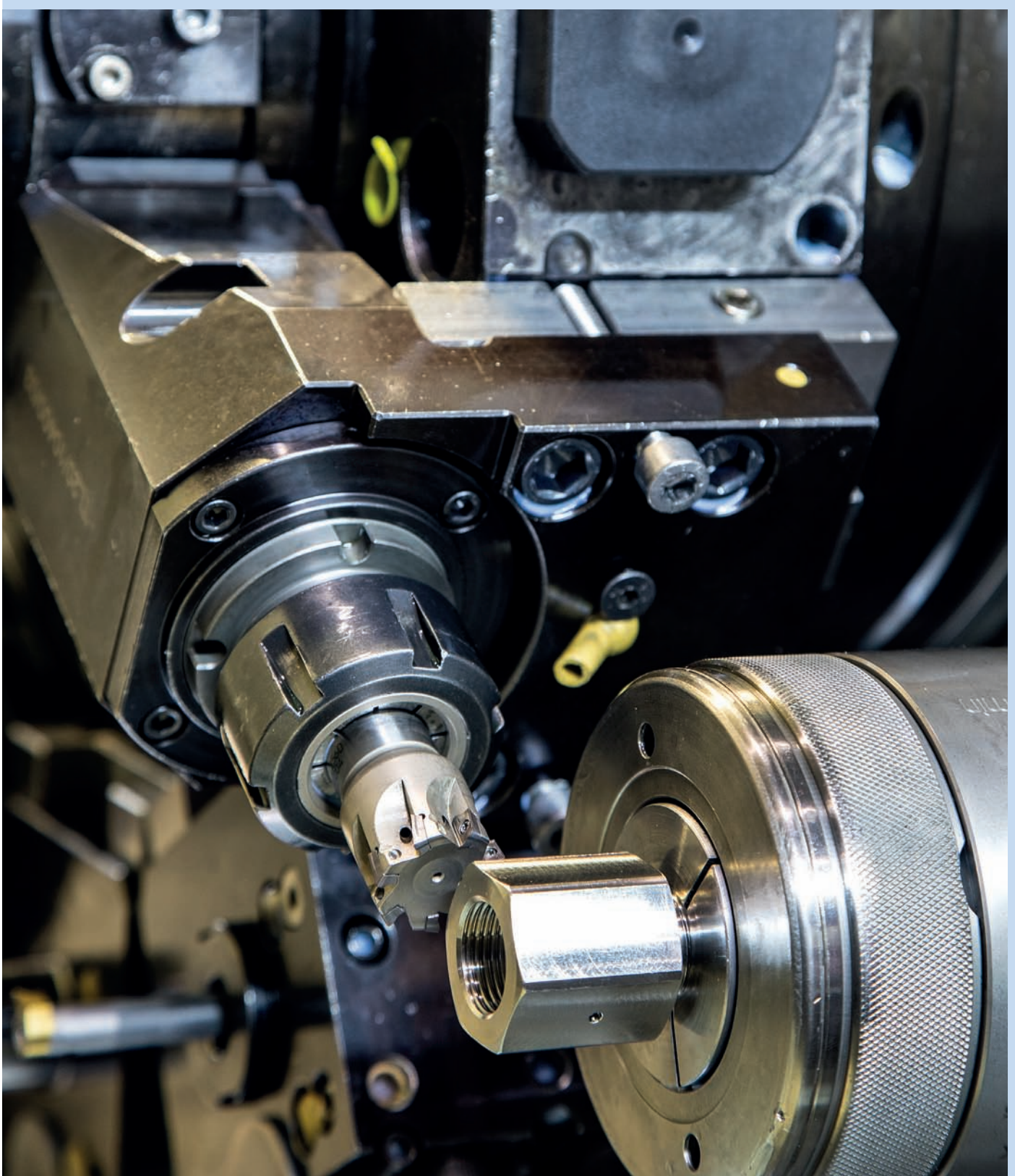



## Series CT



### Technical chart | Quick coupling systems

Nominal bore [mm]	Cv value		Q [L/min] water 20 °C, Δp = 1 bar		Q [m³/h] air 6 bar, 20 °C, Δp = 1 bar		p max. permissible static [bar / psi]
	EA	BA	EA	BA	EA	BA	
							Stainless steel coupled
3		0.45		6.43		22.77	64 / 928
5		0.80		11.42		40.49	64 / 928
7		1.85		26.42		93.62	64 / 928
9		2.75		39.27		139.17	64 / 928
12		4.50		64.26		227.73	64 / 928
19		9.80		139.95		495.95	40 / 580

One side self-sealing (EA). Both sides self-sealing (BA). The pressure values are applicable at a temperature of 20°C. Please inquire about other temperature ranges.

Stated maximum permissible operating pressures (p max. permissible static) only apply to materials specified by us and to operation with group II media according to directive 2014/68/EU. Material combinations, optional materials, as well as other media or other temperature ranges can lead to divergent maximum permissible operating pressures and must be requested separately.

Please note that the maximum permissible operating pressure of the connection and quick coupling system must be considered when determining the operating pressure. Our safety instructions must be followed.

◀◀ The **performance diagram** can be found on the front catalogue fold-out page.

A detailed **connection description** can be found on the back catalogue fold-out page. ▶▶

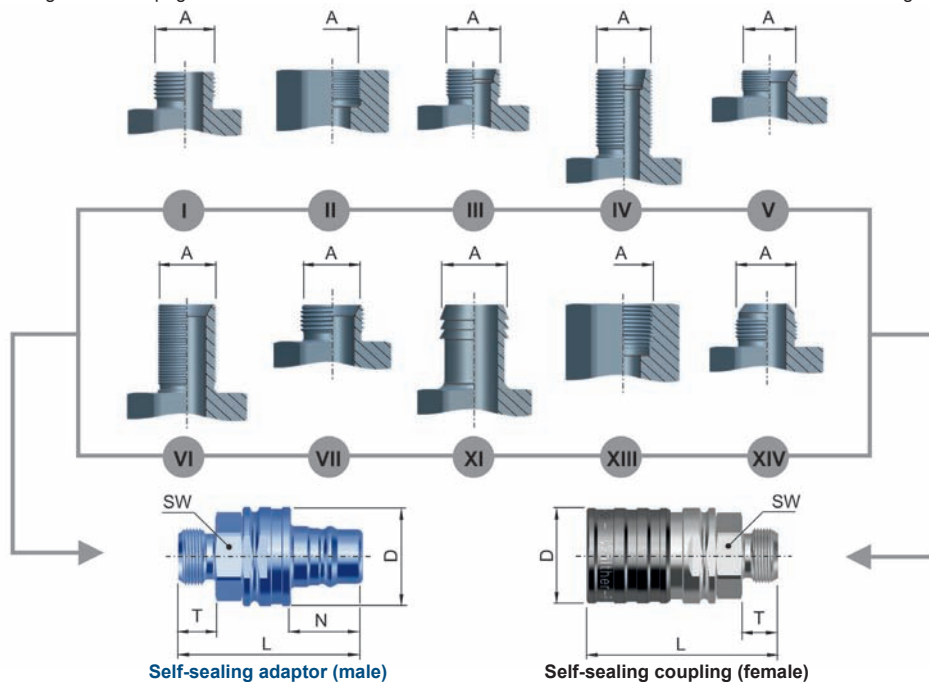



## Features chart | Quick coupling systems

	Product features	Materials	Seals	Additional options
Standard	<ul style="list-style-type: none"> <li>- Low leakage volume during disconnection</li> <li>- Non-squirting</li> <li>- Automatic locking (one-hand operation)</li> <li>- Can be coupled under residual pressure</li> </ul>	02 = Stainless steel 1.4307	2 = FKM 4 = EPDM	BB = 3.1 production EF = 1935/2004-compliant EX = ATEX-compliant FD = FDA-compliant FF = Oil- and grease-free FL = Free from enamel flow-disturbing substances RG* = Ring grips TA = Certified by the Clean Air Act (TA-Luft)
Optional			FFKM	

\*Only available from NB 19

There are special parking stations for self-sealing coupling and self-sealing adaptor of the CT series.

**Note:** Residual leakage quantities or coupling ingress volumes on request.

For example, a complete part number looks like this:

**CT-003-0-SL004-Material-Seal-Additional options-Y../-Z..**



## Product chart | Quick coupling systems

Self-sealing adaptor marked in blue

NB	Product type	A	De-sign	Ran-ge	Pipe AD	Pipe ID	SW	T	D	L	N	Weight Stainless steel	Material-neutral part number
3	Self-sealing coupling (female)	4 mm	XI			3	14	18	21.4	72.9		97	CT-003-0-SL004-...-
3	Self-sealing coupling (female)	6 mm	XI				14	25	21.4	78.7		98	CT-003-0-SL006-...-
3	Self-sealing coupling (female)	BSPP 1/8"	I				14	8	21.4	61.7		98	CT-003-0-WR010-...-
3	Self-sealing coupling (female)	BSPP 1/4"	I				14	11	21.4	64.7		104	CT-003-0-WR013-...-
3	Self-sealing coupling (female)	BSPP 1/8"	II				14	9	21.4	63.7		104	CT-003-0-WR510-...-

NB - Nominal bore [mm] A - Connection SW - Wrench size [mm] T - Thread length [mm] D - Diameter [mm] L - Length [mm] N - Adaptor length [mm] Weight [g]



## Series CT



### Product chart | Quick coupling systems

Self-sealing adaptor marked in blue

NB	Product type	A	De- sign	Ran- ge	Pipe AD	Pipe ID	SW	T	D	L	N	Weight Stainless steel	Material-neutral part number
3	Self-sealing adaptor (male)	4 mm	XI			3	14	18	21.4	58.7	22.2	42	CT-003-2-SL004-...-
3	Self-sealing adaptor (male)	6 mm	XI				14	25	21.4	64.5	22.2	43	CT-003-2-SL006-...-
3	Self-sealing adaptor (male)	BSPP 1/8"	I				14	8	21.4	47.5	22.2	43	CT-003-2-WR010-...-
3	Self-sealing adaptor (male)	BSPP 1/4"	I				14	11	21.4	50.5	22.2	49	CT-003-2-WR013-...-
3	Self-sealing adaptor (male)	BSPP 1/8"	II				14	9	21.4	49.5	22.2	49	CT-003-2-WR510-...-
5	Self-sealing coupling (female)	M 14 x 1.5	V			6	19	10	26.2	67.5		160	CT-005-0-D0614-...-
5	Self-sealing coupling (female)	M 14 x 1.5	VI			6	19	32	26.2	89.5		180	CT-005-0-DV008-...-
5	Self-sealing coupling (female)	M 12 x 1.5	III	L	6	4	19	10	26.2	67.5		160	CT-005-0-L0612-...-
5	Self-sealing coupling (female)	M 14 x 1.5	III	L	8	6	19	10	26.2	67.5		160	CT-005-0-L0814-...-
5	Self-sealing coupling (female)	M 16 x 1.5	III	L	10	8	19	11	26.2	68.5		160	CT-005-0-L1016-...-
5	Self-sealing coupling (female)	M 18 x 1.5	III	L	12	10	19	11	26.2	68.5		160	CT-005-0-L1218-...-
5	Self-sealing coupling (female)	9/16 - 18UNF-3 -JIC	XIV				19	14.1	26.2	71.5		170	CT-005-0-LH014-...-
5	Self-sealing coupling (female)	M 14 x 1.5	IV	L	8	6	19	32	26.2	89.5		180	CT-005-0-LV008-...-
5	Self-sealing coupling (female)	NPT 1/4"	XIII				19	17	26.2	72.5		180	CT-005-0-NP513-...-
5	Self-sealing coupling (female)	NPT 3/8"	XIII				19	18	26.2	72.5		180	CT-005-0-NP517-...-
5	Self-sealing coupling (female)	M 18 x 1.5	III	S	10	6	19	12	26.2	68.5		170	CT-005-0-S1018-...-
5	Self-sealing coupling (female)	M 20 x 1.5	III	S	12	8	22	12	26.2	69.5		180	CT-005-0-S1220-...-
5	Self-sealing Coupling (female)	6 mm	XI			4	19	25	26.2	82.5		160	CT-005-0-SL006-...-
5	Self-sealing coupling (female)	9 mm	XI				19	30	26.2	87.5		160	CT-005-0-SL009-...-
5	Self-sealing coupling (female)	11 mm	XI				19	30	26.2	87.5		170	CT-005-0-SL011-...-

NB - Nominal bore [mm] A - Connection SW - Wrench size [mm] T - Thread length [mm] D - Diameter [mm] L - Length [mm] N - Adaptor length [mm] Weight [g]



**Product chart | Quick coupling systems**

Self-sealing adaptor marked in blue

NB	Product type	A	De- sign	Ran- ge	Pipe AD	Pipe ID	SW	T	D	L	N	Weight Stainless steel	Material-neutral part number
5	Self-sealing coupling (female)	13 mm	XI				19	30	26.2	87.5		180	CT-005-0-SL013-...
5	Self-sealing coupling (female)	BSPP 1/4"	VII			6	19	11	26.2	68.5		160	CT-005-0-VR013-...
5	Self-sealing coupling (female)	BSPP 3/8"	VII			6	19	12	26.2	69.5		170	CT-005-0-VR017-...
5	Self-sealing coupling (female)	BSPP 1/4"	I				19	11	26.2	68.5		160	CT-005-0-WR013-...
5	Self-sealing coupling (female)	BSPP 3/8"	I				19	12	26.2	69.5		170	CT-005-0-WR017-...
5	Self-sealing coupling (female)	BSPP 1/2"	I				22	15	26.2	72.5		190	CT-005-0-WR021-...
5	Self-sealing coupling (female)	BSPP 1/4"	II				19	13	26.2	67.5		170	CT-005-0-WR513-...
5	Self-sealing coupling (female)	BSPP 3/8"	II				22	14	26.2	68.5		170	CT-005-0-WR517-...
5	Self-sealing coupling (female)	M 16 x 1.5	IV	L	10	8	19	32	26.2	89.5		190	CT-005-0-XX211-...
5	Self-sealing adaptor (male)	M 14 x 1.5	V			6	19	10	26	53	22	72	CT-005-2-D0614-...
5	Self-sealing adaptor (male)	M 14 x 1.5	VI			6	19	32	26	75	22	87	CT-005-2-DV008-...
5	Self-sealing adaptor (male)	M 12 x 1.5	III	L	6	4	19	10	26	53	22	67	CT-005-2-L0612-...
5	Self-sealing adaptor (male)	M 14 x 1.5	III	L	8	6	19	10	26	53	22	72	CT-005-2-L0814-...
5	Self-sealing adaptor (male)	M 16 x 1.5	III	L	10	8	19	11	26	54	22	72	CT-005-2-L1016-...
5	Self-sealing adaptor (male)	M 18 x 1.5	III	L	12	10	19	11	26	54	22	72	CT-005-2-L1218-...
5	Self-sealing adaptor (male)	9/16 - 18UNF-3 -JIC	XIV				19	14.1	26	57	22	70	CT-005-2-LH014-...
5	Self-sealing adaptor (male)	M 14 x 1.5	IV	L	8	6	19	32	26	75	22	87	CT-005-2-LV008-...
5	Self-sealing adaptor (male)	NPT 1/4"	XIII				19	17	26	58	22	85	CT-005-2-NP513-...
5	Self-sealing adaptor (male)	NPT 3/8"	XIII				19	18	26	58	22	80	CT-005-2-NP517-...
5	Self-sealing adaptor (male)	M 18 x 1.5	III	S	10	6	19	12	26	55	22	77	CT-005-2-S1018-...
5	Self-sealing adaptor (male)	M 20 x 1.5	III	S	12	8	22	12	26	55	22	87	CT-005-2-S1220-...

NB - Nominal bore [mm] A - Connection SW - Wrench size [mm] T - Thread length [mm] D - Diameter [mm] L - Length [mm] N - Adaptor length [mm] Weight [g]



# Series CT



## Product chart | Quick coupling systems

Self-sealing adaptor marked in blue

NB	Product type	A	De- sign	Ran- ge	Pipe AD	Pipe ID	SW	T	D	L	N	Weight Stainless steel	Material-neutral part number
5	Self-sealing adaptor (male)	6 mm	XI			4	19	25	26	68	22	67	CT-005-2-SL006-...-
5	Self-sealing adaptor (male)	9 mm	XI				19	30	26	73	22	72	CT-005-2-SL009-...-
5	Self-sealing adaptor (male)	11 mm	XI				19	30	26	73	22	77	CT-005-2-SL011-...-
5	Self-sealing adaptor (male)	13 mm	XI				19	30	26	58	22	87	CT-005-2-SL013-...-
5	Self-sealing adaptor (male)	BSPP 1/4 "	VII			6	19	11	26	54	22	72	CT-005-2-VR013-...-
5	Self-sealing adaptor (male)	BSPP 3/8 "	VII			6	19	12	26	55	22	77	CT-005-2-VR017-...-
5	Self-sealing adaptor (male)	BSPP 1/4 "	I				19	11	26	54	22	72	CT-005-2-WR013-...-
5	Self-sealing adaptor (male)	BSPP 3/8 "	I				19	12	26	55	22	77	CT-005-2-WR017-...-
5	Self-sealing adaptor (male)	BSPP 1/2 "	I				22	15	26	58	22	97	CT-005-2-WR021-...-
5	Self-sealing adaptor (male)	BSPP 1/4"	II				19	13	26	53	22	85	CT-005-2-WR513-...-
5	Self-sealing adaptor (male)	BSPP 3/8"	II				22	14	26	54	22	82	CT-005-2-WR517-...-
5	Self-sealing adaptor (male)	M 16 x 1.5	IV	L	10	8	19	32	26	75	22	97	CT-005-2-XX211-...-
7	Self-sealing coupling (female)	M 16 x 1.5	V			8	24	11	32.7	77		260	CT-007-0-D0816-...-
7	Self-sealing coupling (female)	M 16 x 1.5	III			7	24	33.5	32.7	99.5		270	CT-007-0-DV010-...-
7	Self-sealing coupling (female)	M 16 x 1.5	III	L	10	8	24	11	32.7	77		250	CT-007-0-L1016-...-
7	Self-sealing coupling (female)	M 18 x 1.5	III	L	12	10	24	11	32.7	77		250	CT-007-0-L1218-...-
7	Self-sealing coupling (female)	9/16 - 18UNF-3 -JIC	XIV			6.3	24	14.1	32.7	80.1		250	CT-007-0-LH014-...-
7	Self-sealing coupling (female)	NPT 3/8"	XIII				24	18	32.7	82		280	CT-007-0-NP517-...-
7	Self-sealing coupling (female)	M 20 x 1.5	III	S	12	8	24	12	32.7	78		260	CT-007-0-S1220-...-
7	Self-sealing coupling (female)	9 mm	XI			6	24	30	32.7	96		260	CT-007-0-SL009-...-

NB - Nominal bore [mm] A - Connection SW - Wrench size [mm] T - Thread length [mm] D - Diameter [mm] L - Length [mm] N - Adaptor length [mm] Weight [g]



**Product chart | Quick coupling systems**

Self-sealing adaptor marked in blue

NB	Product type	A	De- sign	Ran- ge	Pipe AD	Pipe ID	SW	T	D	L	N	Weight Stainless steel	Material-neutral part number
7	Self-sealing coupling (female)	11 mm	XI				24	30	32.7	96		260	CT-007-0-SL011-...
7	Self-sealing coupling (female)	13 mm	XI				24	30	32.7	96		270	CT-007-0-SL013-...
7	Self-sealing coupling (female)	BSPP 3/8"	VII			7	24	12	32.7	78		250	CT-007-0-VR017-...
7	Self-sealing coupling (female)	BSPP 3/8"	I				24	12	32.7	78		260	CT-007-0-WR017-...
7	Self-sealing coupling (female)	BSPP 1/2"	I				24	15	32.7	81		270	CT-007-0-WR021-...
7	Self-sealing coupling (female)	BSPP 3/8"	II				24	14	32.7	78		270	CT-007-0-WR517-...
7	Self-sealing coupling (female)	BSPP 1/2"	II				27	17	32.7	81		290	CT-007-0-WR521-...
7	Self-sealing adaptor (male)	M 14 x 1.5	V			6	19	10	26	52	27	73	CT-007-2-D0614-...
7	Self-sealing adaptor (male)	M 14 x 1.5	VI			6	19	32	26	74	27	93	CT-007-2-DV008-...
7	Self-sealing adaptor (male)	M 12 x 1.5	III	L	6	4	19	10	26	52	27	73	CT-007-2-L0612-...
7	Self-sealing adaptor (male)	M 14 x 1.5	III	L	8	6	19	10	26	52	27	73	CT-007-2-L0814-...
7	Self-sealing adaptor (male)	M 16 x 1.5	III	L	10	8	19	11	26	53	27	73	CT-007-2-L1016-...
7	Self-sealing adaptor (male)	M 18 x 1.5	III	L	12	10	19	11	26	53	27	73	CT-007-2-L1218-...
7	Self-sealing adaptor (male)	9/16 - 18UNF-3 -JIC	XIV			6,3	19	14.1	26	56	27	71	CT-007-2-LH014-...
7	Self-sealing adaptor (male)	M 14 x 1.5	IV	L	8	6	19	32	26	74	27	93	CT-007-2-LV008-...
7	Self-sealing adaptor (male)	NPT 3/8"	XIII				19	18	26	57	27	82	CT-007-2-NP517-...
7	Self-sealing adaptor (male)	M 18 x 1.5	III	S	10	6	19	12	26	54	27	83	CT-007-2-S1018-...
7	Self-sealing adaptor (male)	M 20 x 1.5	III	S	12	8	22	12	26	54	27	93	CT-007-2-S1220-...
7	Self-sealing adaptor (male)	9 mm	XI			6,5	19	30	26	72	27	73	CT-007-2-SL009-...
7	Self-sealing adaptor (male)	11 mm	XI				19	30	26	72	27	73	CT-007-2-SL011-...
7	Self-sealing adaptor (male)	13 mm	XI				19	30	26	72	27	83	CT-007-2-SL013-...

NB - Nominal bore [mm] A - Connection SW - Wrench size [mm] T - Thread length [mm] D - Diameter [mm] L - Length [mm] N - Adaptor length [mm] Weight [g]



# Series CT



## Product chart | Quick coupling systems

Self-sealing adaptor marked in blue

NB	Product type	A	De- sign	Ran- ge	Pipe AD	Pipe ID	SW	T	D	L	N	Weight Stainless steel	Material-neutral part number
7	Self-sealing adaptor (male)	BSPP 1/4"	VII			6.5	19	11	26	53	27	73	CT-007-2-VR013-...
7	Self-sealing adaptor (male)	BSPP 3/8"	VII			7	19	12	26	54	27	78	CT-007-2-VR017-...
7	Self-sealing adaptor (male)	BSPP 1/4"	I				19	11	26	53	27	73	CT-007-2-WR013-...
7	Self-sealing adaptor (male)	BSPP 3/8"	I				19	12	26	54	27	78	CT-007-2-WR017-...
7	Self-sealing adaptor (male)	BSPP 1/2"	I				22	15	26	57	27	88	CT-007-2-WR021-...
7	Self-sealing adaptor (male)	BSPP 1/4"	II				19	13	26	52	27	83	CT-007-2-WR513-...
7	Self-sealing adaptor (male)	BSPP 3/8"	II				22	14	26	53	27	83	CT-007-2-WR517-...
7	Self-sealing adaptor (male)	M 16 x 1.5	IV	L	10	8	19	32	26	74	27	103	CT-007-2-XX211-...
9	Self-sealing coupling (female)	13 mm	XI				25	30	35.4	101		273	CT-009-0-SL013-...
9	Self-sealing coupling (female)	BSPP 3/8"	I				25	12	35.4	83		333	CT-009-0-WR017-...
9	Self-sealing coupling (female)	BSPP 1/2"	I				25	15	35.4	86		343	CT-009-0-WR021-...
9	Self-sealing coupling (female)	BSPP 1/2"	II				27	17	35.4	86		283	CT-009-0-WR521-...
9	Self-sealing adaptor (male)	9/16 - 18UNF-3 -JIC	XIV			6.3	25	14.1	28	70.1	30	120	CT-009-2-LH014-...
9	Self-sealing adaptor (male)	NPT 1/2"	XIII				27	22	30	73	30	190	CT-009-2-NP521-...
9	Self-sealing adaptor (male)	13 mm	XI				25	30	28	86	30	170	CT-009-2-SL013-...
9	Self-sealing adaptor (male)	BSPP 3/8"	I				25	12	28	68	30	130	CT-009-2-WR017-...
9	Self-sealing adaptor (male)	BSPP 1/2"	I				25	15	28	71	30	140	CT-009-2-WR021-...
9	Self-sealing adaptor (male)	BSPP 1/2"	II				27	17	30	71	30	180	CT-009-2-WR521-...
12	Self-sealing coupling (female)	M 22 x 1.5	V			12	32	17	40	77		380	CT-012-0-D1222-...

NB - Nominal bore [mm] A - Connection SW - Wrench size [mm] T - Thread length [mm] D - Diameter [mm] L - Length [mm] N - Adaptor length [mm] Weight [g]

**Product chart | Quick coupling systems**

Self-sealing adaptor marked in blue

NB	Product type	A	De- sign	Ran- ge	Pipe AD	Pipe ID	SW	T	D	L	N	Weight Stainless steel	Material-neutral part number
12	Self-sealing coupling (female)	M 22 x 1.5	VI			12	32	39	40	104		430	CT-012-0-DV015-...
12	Self-sealing coupling (female)	M 18 x 1.5	III	L	12	10	32	11	40	76		370	CT-012-0-L1218-...
12	Self-sealing coupling (female)	M 22 x 1,5	III	L	15	12	32	12	40	77		380	CT-012-0-L1522-...
12	Self-sealing coupling (female)	7/8 - 14UNF- 3 -JIC	XIV				32	19.3	40	84		400	CT-012-0-LH022-...
12	Self-sealing coupling (female)	NPT 1/2"	XIII				32	22	40	84		480	CT-012-0-NP521-...
12	Self-sealing coupling (female)	M 24 x 1.5	III	S	16	12	32	14	40	79		390	CT-012-0-S1624-...
12	Self-sealing coupling (female)	16 mm	XI				32	35	40	100		390	CT-012-0-SL016-...
12	Self-sealing coupling (female)	19 mm	XI				32	35	40	100		410	CT-012-0-SL019-...
12	Self-sealing coupling (female)	BSPP 1/2"	VII			12	32	15	40	80		380	CT-012-0-VR021-...
12	Self-sealing coupling (female)	BSPP 3/4"	VII			12	32	17	40	82		400	CT-012-0-VR026-...
12	Self-sealing coupling (female)	BSPP 1/2"	I			12	32	15	40	80		380	CT-012-0-WR021-...
12	Self-sealing coupling (female)	BSPP 3/4"	I				32	17	40	82		410	CT-012-0-WR026-...
12	Self-sealing coupling (female)	BSPP 1"	I				32	20	40	86		470	CT-012-0-WR033-...
12	Self-sealing coupling (female)	BSPP 1/2"	II				32	17	40	79		420	CT-012-0-WR521-...
12	Self-sealing coupling (female)	BSPP 3/4"	II				32	19	40	81		400	CT-012-0-WR526-...
12	Self-sealing adaptor (male)	M 22 x 1.5	V			12	32	17	40	73	30	260	CT-012-2-D1222-...
12	Self-sealing adaptor (male)	M 22 x1.5	VI			12	32	39	40	100	30	260	CT-012-2-DV015-...
12	Self-sealing adaptor (male)	M 18 x 1.5	III	L	12	10	32	11	40	72	30	250	CT-012-2-L1218-...
12	Self-sealing adaptor (male)	M 22 x 1.5	III	L	15	12	32	12	40	73	30	260	CT-012-2-L1522-...
12	Self-sealing adaptor (male)	7/8 - 14UNF- 3 -JIC	XIV				32	19.3	40	83	30	280	CT-012-2-LH022-...
12	Self-sealing adaptor (male)	NPT 1/2"	XIII				32	22	40	83	30	360	CT-012-2-NP521-...

NB - Nominal bore [mm] A - Connection SW - Wrench size [mm] T - Thread length [mm] D - Diameter [mm] L - Length [mm] N - Adaptor length [mm] Weight [g]



## Series CT



### Product chart | Quick coupling systems

Self-sealing adaptor marked in blue

NB	Product type	A	De- sign	Ran- ge	Pipe AD	Pipe ID	SW	T	D	L	N	Weight Stainless steel	Material-neutral part number
12	Self-sealing adaptor (male)	M 24 x 1.5	III	S	16	12	32	14	40	75	30	270	CT-012-2-S1624-...
12	Self-sealing adaptor (male)	22 mm	XI				32	35	40	96	30	270	CT-012-2-SL016-...
12	Self-sealing adaptor (male)	25 mm	XI				32	35	40	96	30	290	CT-012-2-SL019-...
12	Self-sealing adaptor (male)	BSPP 1/2"	VII				32	15	40	76	30	260	CT-012-2-VR021-...
12	Self-sealing adaptor (male)	BSPP 3/4"	VII				32	17	40	87	30	280	CT-012-2-VR026-...
12	Self-sealing adaptor (male)	BSPP 1/2"	I				32	15	40	76	30	260	CT-012-2-WR021-...
12	Self-sealing adaptor (male)	BSPP 3/4"	I				32	17	40	78	30	290	CT-012-2-WR026-...
12	Self-sealing adaptor (male)	BSPP 1"	I				32	20	40	82	30	350	CT-012-2-WR033-...
12	Self-sealing adaptor (male)	BSPP 1/2"	II				32	17	40	78	30	300	CT-012-2-WR521-...
12	Self-sealing adaptor (male)	BSPP 3/4"	II				32	19	40	80	30	280	CT-012-2-WR526-...
19	Self-sealing coupling (female)	M 30 x 1.5	VI			19	46	45	58	156		1,470	CT-019-0-DV022-...
19	Self-sealing coupling (female)	M 30 x 2	III	L	22	20	46	14	58	125		1,380	CT-019-0-L2230-...
19	Self-sealing coupling (female)	1 1/16 - 12UN-3 -JIC	XIV			15.5	46	22	58	133		1,360	CT-019-0-LH027-...
19	Self-sealing coupling (female)	NPT 3/4"	XIII				46	23.5	58	127		1,460	CT-019-0-NP526-...
19	Self-sealing coupling (female)	M 36 x 2	III	S	25	20	46	18	58	129		1,410	CT-019-0-S2536-...
19	Self-sealing coupling (female)	19 mm	XI			13	46	35	58	146		1,400	CT-019-0-SL019-...
19	Self-sealing coupling (female)	25 mm	XI				46	40	58	151		1,420	CT-019-0-SL025-...
19	Self-sealing coupling (female)	28 mm	XI				46	45	58	156		1,470	CT-019-0-SL028-...
19	Self-sealing coupling (female)	BSPP 3/4"	VII			17	46	17	58	128		1,380	CT-019-0-VR026-...
19	Self-sealing coupling (female)	BSPP 1"	VII			19	46	20	58	131		1,420	CT-019-0-VR033-...
19	Self-sealing coupling (female)	BSPP 3/4"	I			17	46	17	58	128		1,390	CT-019-0-WR026-...

NB - Nominal bore [mm] A - Connection SW - Wrench size [mm] T - Thread length [mm] D - Diameter [mm] L - Length [mm] N - Adaptor length [mm] Weight [g]

**Product chart | Quick coupling systems**

Self-sealing adaptor marked in blue

NB	Product type	A	De- sign	Ran- ge	Pipe AD	Pipe ID	SW	T	D	L	N	Weight Stainless steel	Material-neutral part number
19	Self-sealing coupling (female)	BSPP 1"	I				46	20	58	131		1,420	CT-019-0-WR033-...
19	Self-sealing coupling (female)	BSPP 3/4"	II				46	19	52	122		1,440	CT-019-0-WR526-...
19	Self-sealing coupling (female)	BSPP 1"	II				46	23	52	126		1,430	CT-019-0-WR533-...
19	Self-sealing adaptor (male)	M 30 x 1.5	VI			19	46	45	52	127	43.6	650	CT-019-2-DV022-...
19	Self-sealing adaptor (male)	M 30 x 2	III	L	22	20	46	14	52	96	43.6	550	CT-019-2-L2230-...
19	Self-sealing adaptor (male)	1 1/16 - 12UN-3 -JIC	XIV			15.5	46	22	52	104	43.6	650	CT-019-2-LH027-...
19	Self-sealing adaptor (male)	NPT 3/4"	XIII				46	23.5	52	98	43.6	640	CT-019-2-NP526-...
19	Self-sealing adaptor (male)	M 36 x 2	III	S	25	20	46	18	52	100	43.6	590	CT-019-2-S2536-...
19	Self-sealing adaptor (male)	19 mm	XI			13	46	35	52	117	43.6	580	CT-019-2-SL019-...
19	Self-sealing adaptor (male)	25 mm	XI				46	40	52	122	43.6	590	CT-019-2-SL025-...
19	Self-sealing adaptor (male)	28 mm	XI				46	45	52	127	43.6	660	CT-019-2-SL028-...
19	Self-sealing adaptor (male)	BSPP 3/4"	VII			17	46	17	52	99	43.6	570	CT-019-2-VR026-...
19	Self-sealing adaptor (male)	BSPP 1"	VII			19	46	20	52	102	43.6	600	CT-019-2-VR033-...
19	Self-sealing adaptor (male)	BSPP 3/4"	I			17	46	17	52	99	43.6	570	CT-019-2-WR026-...
19	Self-sealing adaptor (male)	BSPP 1"	I				46	20	52	102	43.6	600	CT-019-2-WR033-...
19	Self-sealing adaptor (male)	BSPP 3/4"	II				46	19	52	93	43.6	620	CT-019-2-WR526-...
19	Self-sealing adaptor (male)	BSPP 1"	II				46	23	52	97	43.6	610	CT-019-2-WR533-...

NB - Nominal bore [mm] A - Connection SW - Wrench size [mm] T - Thread length [mm] D - Diameter [mm] L - Length [mm] N - Adaptor length [mm] Weight [g]



## Series EH

### Technical chart | Quick coupling systems

Nominal bore [mm]	Cv value	Q [L/min]	Q [m³/h]	p max. permissible static [bar / psi]
		water 20 °C, Δp = 1 bar	air 6 bar, 20 °C, Δp = 1 bar	
	DK	DK	DK	Stainless Steel coupled
25	84	1,200	4,251	50 / 725
50	585	8,354	29,605	30 / 435
80	1,858	26,534	94,027	15 / 218

Thru-type coupling. The pressure values are applicable at a temperature of 20°C. Please inquire about other temperature ranges.

Stated maximum permissible operating pressures (p max. permissible static) only apply to materials specified by us and to operation with group II media according to directive 2014/68/EU. Material combinations, optional materials, as well as other media or other temperature ranges can lead to divergent maximum permissible operating pressures and must be requested separately.

Please note that the maximum permissible operating pressure of the connection and quick coupling system must be considered when determining the operating pressure. Our safety instructions must be followed.

Other nominal bores are available on request.

◀◀ The **performance diagram** can be found on the front catalogue fold-out page.

A detailed **connection description** can be found on the back catalogue fold-out page. ▶▶

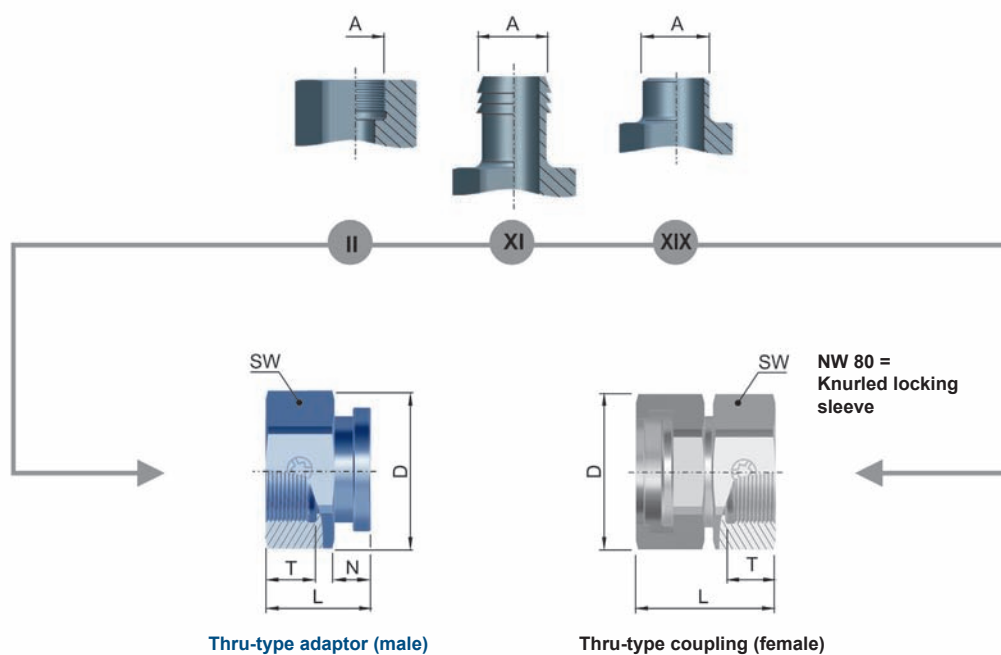





## Series EH

### Features chart | Quick coupling systems

	Product features	Materials	Seals	Additional options
Standard	<ul style="list-style-type: none"> <li>- Maximum flow rate</li> <li>- For high viscosities</li> </ul>	<b>Coupling nut</b> Stainless steel 1.4404/1.4571, nb 80 1.4581 <b>Coupling housing and nipple</b> Stainless steel 1.4404/1.4571	9 = PTFE	EF = 1935/2004-compliant  More options on request (see pages 19-20)
Optional				

Recommended tightening torques: EH-025 = 52 Nm, EH-050 = 140 Nm, EH-080 = 200 Nm

For example, a complete part number looks like this:

**EH-025-1-SL032-Material-Seal-Additional options-Y./-Z..**



### Product chart | Quick coupling systems

Thru-type adaptor marked in blue

NB	Product type	A	Design	SW	T	D	L	N	Weight Stainless steel	Material-neutral part number
25	Thru-type adaptor (male)	32 mm "	XI		45	45	77	22	319	EH-025-1-SL032-..
25	Thru-type adaptor (male)	BSPP 1 1/4"	II	50	25	55.5	53	22	353	EH-025-1-WR542-..
25	Thru-type adaptor (male)	OD 30 ID 24.8 mm"	XIX		20	45	52	22	230	EH-025-1-XX001-..
25	Thru-type coupling (female)	32 mm "	XI	46	45	55	103		576	EH-025-4-SL032-...-
25	Thru-type coupling (female)	BSPP 1 1/4"	II	50	25	55.5	77		633	EH-025-4-WR542-...-
25	Thru-type coupling (female)	OD 30 ID 24.8 mm"	XIX	46	20	55	78		536	EH-025-4-XX001-...-

NB - Nominal bore [mm] A - Connection SW - Wrench size [mm] T - Thread length [mm] D - Diameter [mm] L - Length [mm] N - Adaptor length [mm] Weight [g]



## Series EH

### Product chart | Quick coupling systems

Thru-type adaptor marked in blue

NB	Product type	A	Design	SW	T	D	L	N	Weight Stainless steel	Material-neutral part number
50	Thru-type adaptor (male)	61 mm	XI		55	70	86	20.5	799	EH-050-1-SL060-..
50	Thru-type adaptor (male)	BSPP 2 1/2"	II	85	33	95	60	20.5	973	EH-050-1-WR575-..
50	Thru-type adaptor (male)	OD 57 ID 51.2 mm	XIX		45	70	76	20.5	552	EH-050-1-XX001-..
50	Thru-type coupling (female)	60 mm	XI	70	55	90	123		1,630	EH-050-4-SL060-...-
50	Thru-type coupling (female)	BSPP 2 1/2"	II	85	33	95	85		1,600	EH-050-4-WR575-...-
50	Thru-type coupling (female)	OD 57 ID 51.2 mm	XIX	70	45	82	113		1,369	EH-050-4-XX001-...-
80	Thru-type adaptor (male)	BSPP 5"	II	120	43	135	73	21	1,940	EH-080-1-WR613-..
80	Thru-type adaptor (male)	OD 88,9 ID 82.5 mm	XIX		20	105	51	21	944	EH-080-1-XX005-..
80	Thru-type coupling (female)	BSPP 4"	II	120	43	121	108		3,170	EH-080-4-WR613-...-
80	Thru-type coupling (female)	OD 88,9 ID 82.5 mm	XIX	115	20	121	96		2,278	EH-080-4-XX005-...-

NB - Nominal bore [mm] A - Connection SW - Wrench size [mm] T - Thread length [mm] D - Diameter [mm] L - Length [mm] N - Adaptor length [mm] Weight [g]





# Series KL



## Technical chart | Quick coupling systems

Nominal bore [mm]	Cv value		Q [L/min] water 20 °C, Δp = 1 bar		Q [m³/h] air 6 bar, 20 °C, Δp = 1 bar		p max. permissible static [bar / psi]
	EA	BA	EA	BA	EA	BA	
							PA resp. POM coupled
6	1.00	0.73	14.28	10.43	50.61	36.94	12 / 174
12	3.10	2.32	44.27	33.13	156.88	117.41	10 / 145
30	30.46	23.30	435.00	332.75	1,541.48	1,179.14	10 / 145

One side self-sealing (EA). Both sides self-sealing (BA). The pressure values are applicable at a temperature of 20°C. Please inquire about other temperature ranges.

Stated maximum permissible operating pressures (p max. permissible static) only apply to materials specified by us and to operation with group II media according to directive 2014/68/EU. Material combinations, optional materials, as well as other media or other temperature ranges can lead to divergent maximum permissible operating pressures and must be requested separately.

Please note that the maximum permissible operating pressure of the connection and quick coupling system must be considered when determining the operating pressure. Our safety instructions must be followed.

◀◀ The **performance diagram** can be found on the front catalogue fold-out page.

A detailed **connection description** can be found on the back catalogue fold-out page. ▶▶

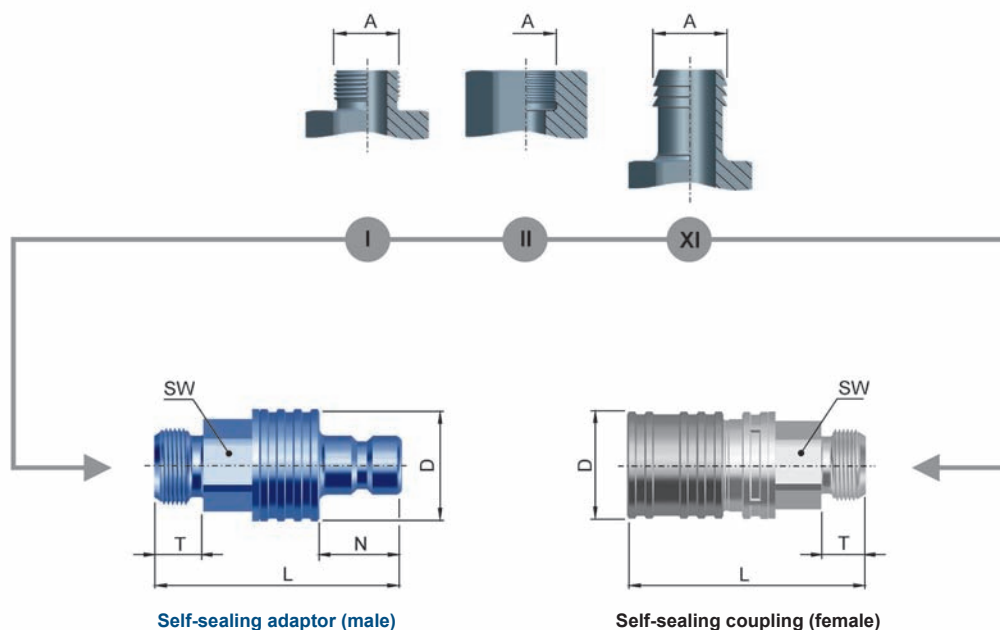



## Features chart | Quick coupling systems

	Product features	Materials	Seals	Additional options
Standard	<ul style="list-style-type: none"> <li>- Balls and springs made of stainless steel</li> </ul> <p><b>KL-006</b> - Can be coupled with LP-006</p> <p><b>KL-012</b> - Can be coupled with LP-012</p>	<p><b>KL-006</b> 50 = Polyamide 11/12, grey (PA) SI-ring POM black</p> <p><b>KL-012</b> 40 = Polyacetal grey (POM) SI-ring black</p> <p><b>KL-030</b> 40 = Polyacetalharz grey (POM) / (POM) black 46 = Polyacetal black (POM)</p>	<p>1 = NBR 2 = FKM 4 = EPDM</p>	<p>OV = Without valve</p> <p><b>KL-006</b> SI = Additional axial safety locking device (outside diameter of 29 mm)</p> <p><b>KL-012</b> SI = Additional axial safety locking device (outside diameter of 44 mm)</p>
Optional		Other materials on request as special types, e.g. PP or PVDF	FFKM	

KL-006: Z14: Self-sealing coupling and adaptor from polypropylene material (PP) anthracite (p max. allowed 3 bar up to 20°C)

KL-012: Z01: Coupling with O-ring sealing (also for slight negative pressure)

**Note:** Some connecting adaptors made of POM can be found in the section Accessories under Connection and reducing adaptors

**Caution:** Self-sealing coupling + OV  $\triangleq$  Product type Thru-type coupling; Self-sealing adaptor + OV  $\triangleq$  Product type Thru-type adaptor

For example, a complete part number looks like this:

**KL-006-0-SL007-Material-Seal-Additional options-Y../-Z..**

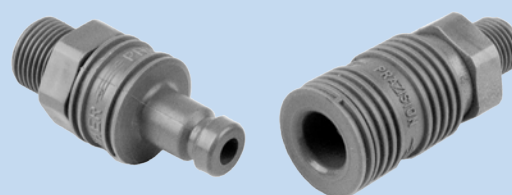

## Product chart | Quick coupling systems

Self-sealing adaptor / thru-type adaptor marked in blue

NB	Product type	A	De-sign	Pipe ID	SW	T	D	L	N	Weight PA	Material-neutral part number
6	Self-sealing coupling (female)	7 mm	XI	4	22	25	24	68.3		16	KL-006-0-SL007-...
6	Self-sealing coupling (female)	9 mm	XI		22	30	24	73.3		17	KL-006-0-SL009-...
6	Self-sealing coupling (female)	11 mm	XI		22	30	24	73.3		18	KL-006-0-SL011-...
6	Self-sealing coupling (female)	13 mm	XI		22	30	24	73.3		19	KL-006-0-SL013-...

NB - Nominal bore [mm] A - Connection SW - Wrench size [mm] T - Thread length [mm] D - Diameter [mm] L - Length [mm] N - Adaptor length [mm] Weight [g]





## Series KL



### Product chart | Quick coupling systems

Self-sealing adaptor / thru-type adaptor marked in blue

NB	Product type	A	De- sign	Pipe ID	SW	T	D	L	N	Weight PA	Material-neutral part number
6	Self-sealing coupling (female)	BSPP 1/4"	I		22	12	24	55.3		16	KL-006-0-WR013-...-
6	Self-sealing coupling (female)	BSPP 3/8"	I		22	12	24	55.3		17	KL-006-0-WR017-...-
6	Self-sealing coupling (female)	BSPP 1/2"	I		22	12	24	55.3		18	KL-006-0-WR021-...-
6	Self-sealing coupling (female)	BSPP 1/4"	II		22	14	24	57.3		19	KL-006-0-WR513-...-
6	Self-sealing coupling (female)	BSPP 3/8"	II		22	14	24	57.3		18	KL-006-0-WR517-...-
6	Thru-type adaptor (male)	7 mm	XI	3		25	12	46	20	3	KL-006-1-SL007-...
6	Thru-type adaptor (male)	9 mm	XI			30	12	51	20	3	KL-006-1-SL009-...
6	Thru-type adaptor (male)	11 mm	XI			30	16	53	20	4	KL-006-1-SL011-...
6	Thru-type adaptor (male)	13 mm	XI			30	16	53	20	5	KL-006-1-SL013-...
6	Thru-type adaptor (male)	BSPP 1/8"	I	4	15	7	16	32	20	3	KL-006-1-WR010-...
6	Thru-type adaptor (male)	BSPP 1/4"	I		19	9	20.5	35	20	4	KL-006-1-WR013-...
6	Thru-type adaptor (male)	BSPP 3/8"	I		22	11	24	38	20	6	KL-006-1-WR017-...
6	Thru-type adaptor (male)	BSPP 1/8"	II		17	13.5	18.5	36	20	4	KL-006-1-WR510-...
6	Thru-type adaptor (male)	BSPP 1/4"	II		17	13.5	18.5	36	20	4	KL-006-1-WR513-...
6	Self-sealing adaptor (male)	7 mm	XI	4	22	25	24	66.5	20	10	KL-006-2-SL007-...-
6	Self-sealing adaptor (male)	9 mm	XI		22	30	24	71.5	20	10	KL-006-2-SL009-...-
6	Self-sealing adaptor (male)	11 mm	XI		22	30	24	71.5	20	11	KL-006-2-SL011-...-
6	Self-sealing adaptor (male)	13 mm	XI		22	30	24	71.5	20	12	KL-006-2-SL013-...-
6	Self-sealing adaptor (male)	BSPP 1/4"	I		22	12	24	53.5	20	10	KL-006-2-WR013-...-
6	Self-sealing adaptor (male)	BSPP 3/8"	I		22	12	24	53.5	20	10	KL-006-2-WR017-...-
6	Self-sealing adaptor (male)	BSPP 1/2"	I		22	12	24	53.3	20	11	KL-006-2-WR021-...-
6	Self-sealing adaptor (male)	BSPP 1/4"	II		22	14	24	55.5	20	13	KL-006-2-WR513-...-
6	Self-sealing adaptor (male)	BSPP 3/8"	II		22	14	24	55.5	20	12	KL-006-2-WR517-...-

NB - Nominal bore [mm] A - Connection SW - Wrench size [mm] T - Thread length [mm] D - Diameter [mm] L - Length [mm] N - Adaptor length [mm] Weight [g]



**Product chart | Quick coupling systems**

Self-sealing adaptor / thru-type adaptor marked in blue

NB	Product type	A	De-sign	Pipe ID	SW	T	D	L	N	Weight POM	Material-neutral part number
12	Self-sealing coupling (female)	16 mm	XI		30	35	40	98		90	KL-012-0-SL016-...
12	Self-sealing coupling (female)	19 mm	XI		30	35	40	102		90	KL-012-0-SL019-...
12	Self-sealing coupling (female)	BSPP 1/2"	I		30	15	40	88		90	KL-012-0-WR021-...
12	Self-sealing coupling (female)	BSPP 3/4"	I		30	17	40	90		90	KL-012-0-WR026-...
12	Self-sealing coupling (female)	BSPP 1/2"	II		30	15	40	82.5		85	KL-012-0-WR521-...
12	Self-sealing coupling (female)	BSPP 3/4"	II		30	17	40	84.5		90	KL-012-0-WR526-...
12	Thru-type adaptor (male)	13 mm	XI	8		30	21	59.5	29.5	13	KL-012-1-SL013-..
12	Thru-type adaptor (male)	16 mm	XI			35	21	64.5	29.5	14	KL-012-1-SL016-..
12	Thru-type adaptor (male)	19 mm	XI			35	25	68.5	29.5	19	KL-012-1-SL019-..
12	Thru-type adaptor (male)	BSPP 1/2"	I		30	15	33.1	54.5	29.5	21	KL-012-1-WR021-..
12	Thru-type adaptor (male)	BSPP 3/4"	I		30	17	33.1	56.5	29.5	25	KL-012-1-WR026-..
12	Thru-type adaptor (male)	BSPP 1/2"	II		30	15	33.1	49	29.5	19	KL-012-1-WR521-..
12	Thru-type adaptor (male)	BSPP 3/4"	II		30	17	33.1	51	29.5	20	KL-012-1-WR526-..
12	Self-sealing adaptor (male)	16 mm	XI		30	35	40	96	29.5	58	KL-012-2-SL016-...
12	Self-sealing adaptor (male)	19 mm	XI		30	35	40	100	29.5	62	KL-012-2-SL019-...
12	Self-sealing adaptor (male)	BSPP 1/2"	I		30	15	40	86	29.5	60	KL-012-2-WR021-...
12	Self-sealing adaptor (male)	BSPP 3/4"	I		30	17	40	88	29.5	60	KL-012-2-WR026-...
12	Self-sealing adaptor (male)	BSPP 1/2"	II		30	15	40	82.5	29.5	55	KL-012-2-WR521-...
12	Self-sealing adaptor (male)	BSPP 3/4"	II		30	17	40	82.5	29.5	60	KL-012-2-WR526-...
30	Self-sealing coupling (female)	BSPP 1 1/2"	II		60	23.5	70	114		330	KL-030-0-WR548-...
30	Self-sealing coupling (female)	BSPP 2"	II		60	26	70	116		320	KL-030-0-WR560-...

NB - Nominal bore [mm] A - Connection SW - Wrench size [mm] T - Thread length [mm] D - Diameter [mm] L - Length [mm] N - Adaptor length [mm] Weight [g]



## Series KL



### Product chart | Quick coupling systems

Self-sealing adaptor / thru-type adaptor marked in blue

NB	Product type	A	De- sign	Pipe ID	SW	T	D	L	N	Weight POM	Material-neutral part number
30	Thru-type adaptor (male)	BSPP 1 1/2"	II		60	25	66	66	35	95	KL-030-1-WR548-..
30	Self-sealing adaptor (male)	BSPP 1 1/2"	II		60	23.5	66	114	35	230	KL-030-2-WR548-..-
30	Self-sealing adaptor (male)	BSPP 2"	II		60	26	66	116	35	220	KL-030-2-WR560-..-
30	Thru-type coupling (female)	BSPP 1 1/2"	II			18	70	84		240	KL-030-4-WR548-..-

NB - Nominal bore [mm]   A - Connection   SW - Wrench size [mm]   T - Thread length [mm]   D - Diameter [mm]   L - Length [mm]   N - Adaptor length [mm]   Weight [g]





# Series LP



## Technical chart | Quick coupling systems

Nominal bore [mm]	Cv value		Q [L/min] water 20 °C, Δp = 1 bar		Q [m³/h] air 6 bar, 20 °C, Δp = 1 bar		p max. permissible static [bar / psi]		
	EA	BA	EA	BA	EA	BA	Steel	Brass	Stainless Steel
							coupled	coupled	coupled
4	0.36	0.30	5.14	4.28	18.22	15.18	110 / 1,595	60 / 870	
6	1.13	0.73	16.14	10.43	57.19	36.94	100 / 1,450	40 / 580	90 / 1,305
7	1.50	1.17	21.42	16.71	75.91	59.21	70 / 1,015	40 / 580	60 / 870
12	4.34	3.28	61.98	46.84	219.63	165.99	60 / 870	30 / 435	50 / 725
19	11.60	8.40	165.67	119.97	587.04	425.10	60 / 870	30 / 435	40 / 580
32	29.40	23.80	419.88	339.90	1,487.84	1,204.44	30 / 435	30 / 435	30 / 435
50	68.00	59.00	971.15	842.62	3,441.26	2,985.80	30 / 435	20 / 290	30 / 435

One side self-sealing (EA). Both sides self-sealing (BA). The pressure values are applicable at a temperature of 20°C. Please inquire about other temperature ranges.

Stated maximum permissible operating pressures (p max. permissible static) only apply to materials specified by us and to operation with group II media according to directive 2014/68/EU. Material combinations, optional materials, as well as other media or other temperature ranges can lead to divergent maximum permissible operating pressures and must be requested separately.

Please note that the maximum permissible operating pressure of the connection and quick coupling system must be considered when determining the operating pressure. Our safety instructions must be followed.

◀◀ The **performance diagram** can be found on the front catalogue fold-out page.

A detailed **connection description** can be found on the back catalogue fold-out page. ▶▶

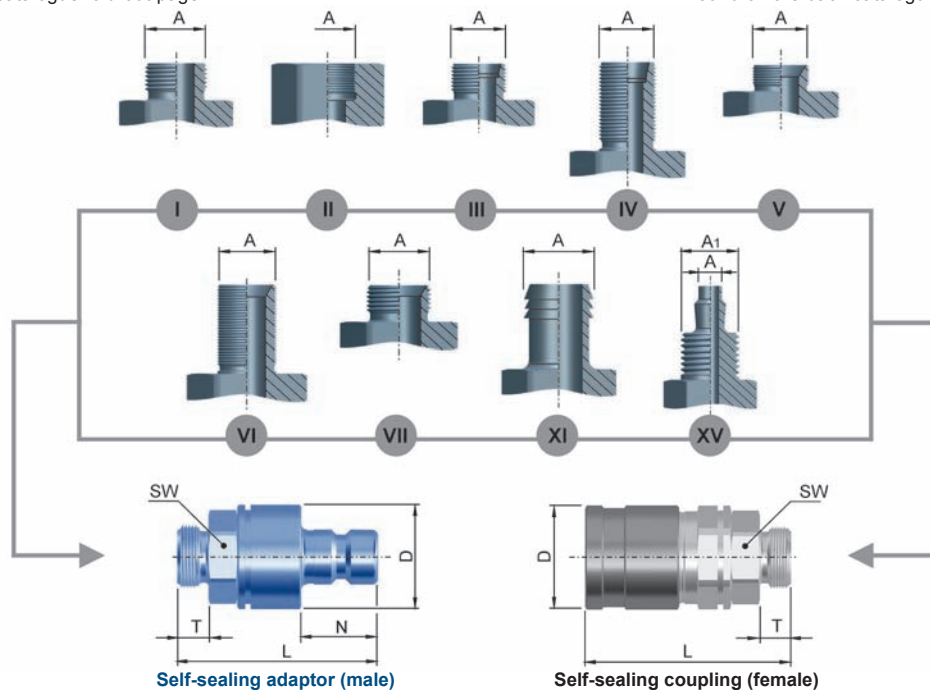

**Features chart | Quick coupling systems**

	Product features	Materials	Seals	Additional options
Standard	<b>LP-004</b> - See also LV-004 in extended, non-squirting design  <b>LP-006 / 012</b> - Can be coupled with KL-006 / 012 When combined with KL, the p max. of the KL series should be taken into account	01 = Stainless steel 1.4404/1.4571 or similar 11 = Steel zinc plated 21 = Brass passivated 22 = Brass chrome plated  <b>LP-004 also</b> 23 = Brass nickel plated (not available in 01 and 22)	1 = NBR 2 = FKM 4 = EPDM	BB = 3.1 production EX = ATEX-compliant FD = FDA-compliant FF = Oil and grease-free FL = Free of substances that impair paint consistency GG = With ring grips Ø 130-220 (die-cast aluminium) GL = Smooth design GX = Smooth design with key flat-locking piece OV = Without valve TA = Certified by the Clean Air Act (TA-Luft) SI = Secured with a safety lock  <b>LP-006 to LP-019</b> VH = With locking aid
Optional	<b>LP-006 to 019</b> - Non-squirting  <b>LP-032 / 050</b> - Not suitable for vacuum pressure	13 = Steel chemically nickel plated 24 = Brass chemically nickel plated  <b>LP-032/050 also</b> 31 = Aluminium silver anodized	FFKM	

LP-006: SI - Outside diameter 29 mm  
 LP-007: SI - Outside diameter 34 mm

LP-012: SI - Outside diameter 44 mm  
 LP-019: SI - Outside diameter 58 mm

LP-032: SI - Outside diameter 89 mm  
 LP-050: SI - Outside diameter 116 mm

**Attention:** GG and SI cannot be combined = Special version - please enquire

**Attention:** Self-sealing coupling + OV ≙ Product type Thru-type coupling; Self-sealing adaptor + OV ≙ Product type Thru-type adaptor

For example, a complete part number looks like this:

**LP-004-0-SL004-Material-Seal-Additional options-Y../-Z..**

**Product chart | Quick coupling systems**

Self-sealing adaptor / thru-type adaptor marked in blue

NB	Product type	A / A1	De- sign	Ran- ge	Pipe AD	Pipe ID	SW	T	D	L	N	Weight Steel	Material-neutral part number
4	Self-sealing coupling (female)	4 mm	XI			3	14	19	18	50		47	LP-004-0-SL004-...-
4	Self-sealing coupling (female)	6 mm	XI				14	25	18	60.5		50	LP-004-0-SL006-...-

NB - Nominal bore [mm] A / A1 - Connection SW - Wrench size [mm] T - Thread length [mm] D - Diameter [mm] L - Length [mm] N - Adaptor length [mm] Weight [g]





## Series LP



### Product chart | Quick coupling systems

Self-sealing adaptor / thru-type adaptor marked in blue

NB	Product type	A / A1	De- sign	Ran- ge	Pipe AD	Pipe ID	SW	T	D	L	N	Weight Steel	Material-neutral part number
4	Self-sealing coupling (female)	OD 6 ID 4 mm M 10 x 1	XV			3	14	16	18	51.5		60	LP-004-0-SW004-...
4	Self-sealing coupling (female)	BSPP 1/8"	I				14	8	18	43.5		50	LP-004-0-WR010-...
4	Self-sealing coupling (female)	BSPP 1/4"	I				14	11	18	46.5		55	LP-004-0-WR013-...
4	Self-sealing coupling (female)	BSPP 1/8"	II				14	9	18	45.5		55	LP-004-0-WR510-...
4	Thru-type adaptor (male)	4 mm	XI			3		18	12	37	16	9	LP-004-1-SL004-...
4	Thru-type adaptor (male)	6 mm	XI					25	12	44	16	11	LP-004-1-SL006-...
4	Thru-type adaptor (male)	OD 6 ID 4 mm M 10 x 1	XV			3	12	16	13.2	37	16	22	LP-004-1-SW004-...
4	Thru-type adaptor (male)	BSPP 1/8"	I				14	8	16.2	29	16	15	LP-004-1-WR010-...
4	Thru-type adaptor (male)	BSPP 1/4"	I				14	11	16.2	32	16	20	LP-004-1-WR013-...
4	Thru-type adaptor (male)	BSPP 1/8"	II				14	9	16.2	29	16	18	LP-004-1-WR510-...
4	Self-sealing adaptor (male)	4 mm	XI			3	14	18	18	53	16	33	LP-004-2-SL004-...
4	Self-sealing adaptor (male)	6 mm	XI				14	25	18	60	16	36	LP-004-2-SL006-...
4	Self-sealing adaptor (male)	OD 6 ID 4 mm M 10 x 1	XV			3	14	16	18	51	16	45	LP-004-2-SW004-...
4	Self-sealing adaptor (male)	BSPP 1/8"	I				14	8	18	43	16	36	LP-004-2-WR010-...
4	Self-sealing adaptor (male)	BSPP 1/4"	I				14	11	18	46	16	41	LP-004-2-WR013-...
4	Self-sealing adaptor (male)	BSPP 1/8"	II				14	9	18	45	16	41	LP-004-2-WR510-...
6	Self-sealing coupling (female)	M 14 x 1.5	V			6	19	10	25	57		110	LP-006-0-D0614-...
6	Self-sealing coupling (female)	M 12 x 1.5	III	L	6	4	19	10	25	57		110	LP-006-0-L0612-...
6	Self-sealing coupling (female)	M 14 x 1.5	III	L	8	6	19	10	25	57		110	LP-006-0-L0814-...
6	Self-sealing coupling (female)	M 16 x 1.5	III	L	10	8	19	11	25	58		110	LP-006-0-L1016-...
6	Self-sealing coupling (female)	M 18 x 1.5	III	L	12	10	19	11	25	58		110	LP-006-0-L1218-...

NB - Nominal bore [mm] A / A1 - Connection SW - Wrench size [mm] T - Thread length [mm] D - Diameter [mm] L - Length [mm] N - Adaptor length [mm] Weight [g]



**Product chart | Quick coupling systems**

Self-sealing adaptor / thru-type adaptor marked in blue

NB	Product type	A / A1	De-sign	Ran-ge	Pipe AD	Pipe ID	SW	T	D	L	N	Weight Steel	Material-neutral part number
6	Self-sealing coupling (female)	M 14 x 1.5	IV	L	8	6	19	32	25	79		130	LP-006-0-LV008-...
6	Self-sealing coupling (female)	M 16 x 1.5	III	S	8	4	19	12	25	59		120	LP-006-0-S0816-...
6	Self-sealing coupling (female)	M 18 x 1.5	III	S	10	6	19	12	25	59		120	LP-006-0-S1018-...
6	Self-sealing coupling (female)	M 20 x 1.5	III	S	12	8	22	12	25	59		130	LP-006-0-S1220-...
6	Self-sealing coupling (female)	6 mm	XI			4	19	25	25	72		110	LP-006-0-SL006-...
6	Self-sealing coupling (female)	9 mm	XI				19	30	25	77		110	LP-006-0-SL009-...
6	Self-sealing coupling (female)	11 mm	XI				19	30	25	77		120	LP-006-0-SL011-...
6	Self-sealing coupling (female)	13 mm	XI				19	30	25	77		130	LP-006-0-SL013-...
6	Self-sealing coupling (female)	BSPP 3/8"	VII			6	19	11	25	58		110	LP-006-0-VR013-...
6	Self-sealing coupling (female)	BSPP 1/4"	VII			6	19	12	25	59		120	LP-006-0-VR017-...
6	Self-sealing coupling (female)	BSPP 3/8"	IX				27	12	25	64		160	LP-006-0-WE017-...
6	Self-sealing coupling (female)	BSPP 1/4"	I				19	11	25	58		110	LP-006-0-WR013-...
6	Self-sealing coupling (female)	BSPP 3/8"	I				19	12	25	59		120	LP-006-0-WR017-...
6	Self-sealing coupling (female)	BSPP 1/2"	I				22	15	25	62		140	LP-006-0-WR021-...
6	Self-sealing coupling (female)	BSPP 1/4"	II				19	13	25	57		120	LP-006-0-WR513-...
6	Self-sealing coupling (female)	BSPP 3/8"	II				22	14	25	58		120	LP-006-0-WR517-...
6	Self-sealing coupling (female)	M 16 x 1.5	IV	L	10	8	19	32	25	79		140	LP-006-0-XX211-...
6	Thru-type adaptor (male)	6 mm	XI			4			12	46	20	16	LP-006-1-SL006-...
6	Thru-type adaptor (male)	9 mm	XI						12	51	20	20	LP-006-1-SL009-...
6	Thru-type adaptor (male)	11 mm	XI						16	53	20	31	LP-006-1-SL011-...
6	Thru-type adaptor (male)	13 mm	XI						16	53	20	41	LP-006-1-SL013-...
6	Thru-type adaptor (male)	BSPP 1/8"	I			5	14	8	15.5	35	20	22	LP-006-1-WR010-...

NB - Nominal bore [mm] A / A1 - Connection SW - Wrench size [mm] T - Thread length [mm] D - Diameter [mm] L - Length [mm] N - Adaptor length [mm] Weight [g]



## Series LP



### Product chart | Quick coupling systems

Self-sealing adaptor / thru-type adaptor marked in blue

NB	Product type	A / A1	De- sign	Ran- ge	Pipe AD	Pipe ID	SW	T	D	L	N	Weight Steel	Material-neutral part number
6	Thru-type adaptor (male)	BSPP 1/4"	I				14	11	15.5	39	20	25	LP-006-1-WR013-..
6	Thru-type adaptor (male)	BSPP 3/8"	I				19	12	21	40.5	20	39	LP-006-1-WR017-..
6	Thru-type adaptor (male)	BSPP 1/8"	II				15	9	16.5	31	20	20	LP-006-1-WR510-..
6	Thru-type adaptor (male)	BSPP 1/4"	II				17	13	18.9	36	20	28	LP-006-1-WR513-..
6	Thru-type adaptor (male)	BSPP 3/8"	II				22	14	24	38	20	44	LP-006-1-WR517-..
6	Self-sealing adaptor (male)	M 14 x 1.5	V			6	19	10	25	55	20	85	LP-006-2-D0614-...-
6	Self-sealing adaptor (male)	M 12 x 1.5	III	L	6	4	19	10	25	55	20	80	LP-006-2-L0612-...-
6	Self-sealing Adaptor (male)	M 14 x 1.5	III	L	8	6	19	10	25	55	20	85	LP-006-2-L0814-...-
6	Self-sealing adaptor (male)	M 16 x 1.5	III	L	10	8	19	11	25	56	20	85	LP-006-2-L1016-...-
6	Self-sealing adaptor (male)	M 18 x 1.5	III	L	12	10	19	11	25	56	20	85	LP-006-2-L1218-...-
6	Self-sealing adaptor (male)	M 14 x 1.5	IV	L	8	6	19	32	25	77	20	100	LP-006-2-LV008-...-
6	Self-sealing adaptor (male)	M 16 x 1.5	III	S	8	4	19	12	25	57	20	90	LP-006-2-S0816-...-
6	Self-sealing adaptor (male)	M 18 x 1.5	III	S	10	6	19	12	25	57	20	90	LP-006-2-S1018-...-
6	Self-sealing adaptor (male)	M 20 x 1.5	III	S	12	8	22	12	25	57	20	100	LP-006-2-S1220-...-
6	Self-sealing adaptor (male)	6 mm	XI			4	19	25	25	70	20	80	LP-006-2-SL006-...-
6	Self-sealing adaptor (male)	9 mm	XI				19	30	25	75	20	85	LP-006-2-SL009-...-
6	Self-sealing adaptor (male)	11 mm	XI				19	30	25	75	20	90	LP-006-2-SL011-...-
6	Self-sealing adaptor (male)	13 mm	XI				19	30	25	75	20	100	LP-006-2-SL013-...-
6	Self-sealing adaptor (male)	BSPP 3/8"	VII			6	19	11	25	56	20	85	LP-006-2-VR013-...-
6	Self-sealing adaptor (male)	BSPP 1/4"	VII			6	19	12	25	57	20	90	LP-006-2-VR017-...-
6	Self-sealing adaptor (male)	BSPP 3/8"	IX				27	12	25	62	20	130	LP-006-2-WE017-...-
6	Self-sealing adaptor (male)	BSPP 1/4"	I				19	11	25	56	20	85	LP-006-2-WR013-...-

NB - Nominal bore [mm] A / A1 - Connection SW - Wrench size [mm] T - Thread length [mm] D - Diameter [mm] L - Length [mm] N - Adaptor length [mm] Weight [g]

**Product chart | Quick coupling systems**

Self-sealing adaptor / thru-type adaptor marked in blue

NB	Product type	A / A1	De-sign	Ran-ge	Pipe AD	Pipe ID	SW	T	D	L	N	Weight Steel	Material-neutral part number
6	Self-sealing adaptor (male)	BSPP 3/8"	I				19	12	25	57	20	90	LP-006-2-WR017-...
6	Self-sealing adaptor (male)	BSPP 1/2"	I				22	15	25	60	20	110	LP-006-2-WR021-...
6	Self-sealing adaptor (male)	BSPP 1/4"	II				19	13	25	55	20	90	LP-006-2-WR513-...
6	Self-sealing adaptor (male)	BSPP 3/8"	II				22	14	25	56	20	95	LP-006-2-WR517-...
6	Self-sealing adaptor (male)	M 16 x 1.5	IV	L	10	8	19	32	25	77	20	110	LP-006-2-XX211-...
7	Self-sealing coupling (female)	M 16 x 1.5	V			8	24	11	30	67		200	LP-007-0-D0816-...
7	Self-sealing coupling (female)	M 16 x 1.5	VI			8	24	33.5	30	89.5		210	LP-007-0-DV010-...
7	Self-sealing coupling (female)	M 16 x 1.5	III	L	10	8	24	11	30	67		190	LP-007-0-L1016-...
7	Self-sealing coupling (female)	M 18 x 1,5	III	L	12	10	24	11	30	67		190	LP-007-0-L1218-...
7	Self-sealing coupling (female)	M 18 x 1.5	III	S	10	6	24	12	30	68		200	LP-007-0-S1018-...
7	Self-sealing coupling (female)	M 20 x 1.5	III	S	12	8	24	12	30	68		200	LP-007-0-S1220-...
7	Self-sealing coupling (female)	9 mm	XI			6	24	30	30	86		200	LP-007-0-SL009-...
7	Self-sealing coupling (female)	11 mm	XI				24	30	30	86		200	LP-007-0-SL011-...
7	Self-sealing coupling (female)	13 mm	XI				24	30	30	86		210	LP-007-0-SL013-...
7	Self-sealing coupling (female)	BSPP 3/8"	VII			7	24	12	30	68		190	LP-007-0-VR017-...
7	Self-sealing coupling (female)	BSPP 3/8"	IX				27	12	30	71		220	LP-007-0-WE017-...
7	Self-sealing coupling (female)	BSPP 3/8"	I				24	12	30	68		200	LP-007-0-WR017-...
7	Self-sealing coupling (female)	BSPP 1/2"	I				24	15	30	71		210	LP-007-0-WR021-...
7	Self-sealing coupling (female)	BSPP 3/8"	II				24	14	30	68		210	LP-007-0-WR517-...
7	Self-sealing coupling (female)	BSPP 1/2"	II				27	17	30	71		230	LP-007-0-WR521-...
7	Thru-type adaptor (male)	9 mm	XI			6		30	14	54.5	23.3	29	LP-007-1-SL009-...

NB - Nominal bore [mm] A / A1 - Connection SW - Wrench size [mm] T - Thread length [mm] D - Diameter [mm] L - Length [mm] N - Adaptor length [mm] Weight [g]



## Series LP



### Product chart | Quick coupling systems

Self-sealing adaptor / thru-type adaptor marked in blue

NB	Product type	A / A1	De-sign	Ran-ge	Pipe AD	Pipe ID	SW	T	D	L	N	Weight Steel	Material-neutral part number
7	Thru-type adaptor (male)	11 mm	XI					30	18	56.5	23.3	37	LP-007-1-SL011-..
7	Thru-type adaptor (male)	13 mm	XI					30	18	56.5	23.3	46	LP-007-1-SL013-..
7	Thru-type adaptor (male)	BSPP 1/4"	I				17	11	18.9	41.8	23.3	35	LP-007-1-WR013-..
7	Thru-type adaptor (male)	BSPP 3/8"	I				19	12	21.1	43.8	23.3	45	LP-007-1-WR017-..
7	Thru-type adaptor (male)	BSPP 1/2"	I				24	15	26.7	48.3	23.3	70	LP-007-1-WR021-..
7	Thru-type adaptor (male)	BSPP 1/4"	II				17	13	18.9	40.5	23.3	37	LP-007-1-WR513-..
7	Thru-type adaptor (male)	BSPP 3/8"	II				22	14	24	41.5	23.3	55	LP-007-1-WR517-..
7	Thru-type adaptor (male)	BSPP 1/2"	II				27	17	30	44.5	23.3	75	LP-007-1-WR521-..
7	Self-sealing adaptor (male)	M 16 x 1.5	V			8	24	11	30	65	23.3	150	LP-007-2-D0816-...-
7	Self-sealing adaptor (male)	M 16 x 1.5	VI			8	24	33.5	30	87.5	23.3	160	LP-007-2-DV010-...-
7	Self-sealing adaptor (male)	M 16 x 1.5	III	L	10	8	24	11	30	65	23.3	140	LP-007-2-L1016-...-
7	Self-sealing adaptor (male)	M 18 x 1.5	III	L	12	10	24	11	30	65	23.3	140	LP-007-2-L1218-...-
7	Self-sealing adaptor (male)	M 18 x 1.5	III	S	10	6	24	12	30	66	23.3	150	LP-007-2-S1018-...-
7	Self-sealing adaptor (male)	M 20 x 1.5	III	S	12	8	24	12	30	66	23.3	150	LP-007-2-S1220-...-
7	Self-sealing adaptor (male)	9 mm	XI			6	24	30	30	84	23.3	150	LP-007-2-SL009-...-
7	Self-sealing adaptor (male)	11 mm	XI				24	30	30	84	23.3	150	LP-007-2-SL011-...-
7	Self-sealing adaptor (male)	13 mm	XI				24	30	30	84	23.3	160	LP-007-2-SL013-...-
7	Self-sealing adaptor (male)	BSPP 3/8"	VII			7	24	12	30	66	23.3	150	LP-007-2-VR017-...-
7	Self-sealing adaptor (male)	BSPP 3/8"	IX				27	12	30	69	23.3	170	LP-007-2-WE017-...-
7	Self-sealing adaptor (male)	BSPP 3/8"	I				24	12	30	66	23.3	150	LP-007-2-WR017-...-
7	Self-sealing adaptor (male)	BSPP 1/2"	I				24	15	30	69	23.3	170	LP-007-2-WR021-...-
7	Self-sealing adaptor (male)	BSPP 3/8"	II				24	14	30	66	23.3	160	LP-007-2-WR517-...-

NB - Nominal bore [mm] A / A1 - Connection SW - Wrench size [mm] T - Thread length [mm] D - Diameter [mm] L - Length [mm] N - Adaptor length [mm] Weight [g]

**Product chart | Quick coupling systems**

Self-sealing adaptor / thru-type adaptor marked in blue

NB	Product type	A / A1	De-sign	Ran-ge	Pipe AD	Pipe ID	SW	T	D	L	N	Weight Steel	Material-neutral part number
7	Self-sealing adaptor (male)	BSPP 1/2"	II				27	17	30	69	23.3	180	LP-007-2-WR521-...
12	Self-sealing coupling (female)	M 18 x 1.5	V			10	32	11	40	78		370	LP-012-0-D1018-...
12	Self-sealing coupling (female)	M 22 x 1.5	V			12	32	12	40	79		380	LP-012-0-D1222-...
12	Self-sealing coupling (female)	M 22 x 1.5	VI			12	32	39	40	106		430	LP-012-0-DV015-...
12	Self-sealing coupling (female)	M 18 x 1.5	III	L	12	10	32	11	40	78		370	LP-012-0-L1218-...
12	Self-sealing coupling (female)	M 22 x 1.5	III	L	15	12	32	12	40	79		380	LP-012-0-L1522-...
12	Self-sealing coupling (female)	M 24 x 1.5	III	S	16	12	32	14	40	81		390	LP-012-0-S1624-...
12	Self-sealing coupling (female)	16 mm	XI				32	35	40	102		390	LP-012-0-SL016-...
12	Self-sealing coupling (female)	19 mm	XI				32	35	40	102		410	LP-012-0-SL019-...
12	Self-sealing coupling (female)	BSPP 1/2"	VII			12	32	15	40	82		380	LP-012-0-VR021-...
12	Self-sealing coupling (female)	BSPP 3/4"	VII			12	32	17	40	84		400	LP-012-0-VR026-...
12	Self-sealing coupling (female)	BSPP 1/2"	I				32	15	40	82		380	LP-012-0-WR021-...
12	Self-sealing coupling (female)	BSPP 3/4"	I				32	17	40	84		410	LP-012-0-WR026-...
12	Self-sealing coupling (female)	BSPP 1"	I				36	20	40	88		470	LP-012-0-WR033-...
12	Self-sealing coupling (female)	BSPP 1/2"	II				32	17	40	81		420	LP-012-0-WR521-...
12	Self-sealing coupling (female)	BSPP 3/4"	II				32	19	40	83		400	LP-012-0-WR526-...
12	Thru-type adaptor (male)	13 mm	XI			8		30	21	61	29.5	70	LP-012-1-SL013-...
12	Thru-type adaptor (male)	16 mm	XI					35	21	66	29.5	75	LP-012-1-SL016-...
12	Thru-type adaptor (male)	19 mm	XI					35	25	68.5	29.5	110	LP-012-1-SL019-...
12	Thru-type adaptor (male)	BSPP 3/8"	I			9	27	12	30	49.5	29.5	90	LP-012-1-WR017-...
12	Thru-type adaptor (male)	BSPP 1/2"	I				27	15	30	54.5	29.5	100	LP-012-1-WR021-...

NB - Nominal bore [mm] A / A1 - Connection SW - Wrench size [mm] T - Thread length [mm] D - Diameter [mm] L - Length [mm] N - Adaptor length [mm] Weight [g]



## Series LP



### Product chart | Quick coupling systems

Self-sealing adaptor / thru-type adaptor marked in blue

NB	Product type	A / A1	De- sign	Ran- ge	Pipe AD	Pipe ID	SW	T	D	L	N	Weight Steel	Material-neutral part number
12	Thru-type adaptor (male)	BSPP 3/4"	I				30	17	33	54.5	29.5	140	LP-012-1-WR026-...
12	Thru-type adaptor (male)	BSPP 1/2"	II				27	17	30	50.5	29.5	100	LP-012-1-WR521-...
12	Thru-type adaptor (male)	BSPP 3/4"	II				32	19	35.5	52.5	29.5	120	LP-012-1-WR526-...
12	Self-sealing adaptor (male)	M 18 x 1.5	V			10	32	11	40	76	29.5	280	LP-012-2-D1018-...
12	Self-sealing adaptor (male)	M 22 x 1.5	V			12	32	12	40	77	29.5	290	LP-012-2-D1222-...
12	Self-sealing adaptor (male)	M 22 x 1.5	VI			12	32	39	40	104	29.5	340	LP-012-2-DV015-...
12	Self-sealing adaptor (male)	M 18 x 1.5	III	L	12	10	32	11	40	76	29.5	280	LP-012-2-L1218-...
12	Self-sealing adaptor (male)	M 22 x 1.5	III	L	15	12	32	12	40	77	29.5	290	LP-012-2-L1522-...
12	Self-sealing adaptor (male)	M 24 x 1.5	III	S	16	12	32	14	40	79	29.5	290	LP-012-2-S1624-...
12	Self-sealing adaptor (male)	16 mm	XI				32	35	40	100	29.5	300	LP-012-2-SL016-...
12	Self-sealing adaptor (male)	19 mm	XI				32	35	40	100	29.5	320	LP-012-2-SL019-...
12	Self-sealing adaptor (male)	BSPP 1/2"	VII			12	32	15	40	80	29.5	290	LP-012-2-VR021-...
12	Self-sealing adaptor (male)	BSPP 3/4"	VII			12	32	17	40	82	29.5	310	LP-012-2-VR026-...
12	Self-sealing adaptor (male)	BSPP 1/2"	I				32	15	40	80	29.5	290	LP-012-2-WR021-...
12	Self-sealing adaptor (male)	BSPP 3/4"	I				32	17	40	82	29.5	320	LP-012-2-WR026-...
12	Self-sealing adaptor (male)	BSPP 1"	I				36	20	40	86	29.5	380	LP-012-2-WR033-...
12	Self-sealing adaptor (male)	BSPP 1/2"	II				32	17	40	79	29.5	330	LP-012-2-WR521-...
12	Self-sealing adaptor (male)	BSPP 3/4"	II				32	19	40	81	29.5	310	LP-012-2-WR526-...
19	Self-sealing coupling (female)	M 26 x 1.5	V			15	46	12	54	95		830	LP-019-0-D1526-...
19	Self-sealing coupling (female)	M 30 x 1.5	V			19	46	14	54	97		830	LP-019-0-D1930-...
19	Self-sealing coupling (female)	M 30 x 1.5	VI			19	46	45	54	128		920	LP-019-0-DV022-...

NB - Nominal bore [mm] A / A1 - Connection SW - Wrench size [mm] T - Thread length [mm] D - Diameter [mm] L - Length [mm] N - Adaptor length [mm] Weight [g]



**Product chart | Quick coupling systems**

Self-sealing adaptor / thru-type adaptor marked in blue

NB	Product type	A / A1	De-sign	Ran-ge	Pipe AD	Pipe ID	SW	T	D	L	N	Weight Steel	Material-neutral part number
19	Self-sealing coupling (female)	M 26 x 1.5	III	L	18	16	46	12	54	95		830	LP-019-0-L1826-...
19	Self-sealing coupling (female)	M 30 x 2	III	L	22	20	46	14	54	97		830	LP-019-0-L2230-...
19	Self-sealing coupling (female)	M 30 x 2	III	S	20	16	46	16	54	99		850	LP-019-0-S2030-...
19	Self-sealing coupling (female)	M 36 x 2	III	S	25	20	46	18	54	101		860	LP-019-0-S2536-...
19	Self-sealing coupling (female)	19 mm	XI			13	46	35	54	118		850	LP-019-0-SL019-...
19	Self-sealing coupling (female)	25 mm	XI				46	40	54	123		870	LP-019-0-SL025-...
19	Self-sealing coupling (female)	28 mm	XI				46	45	54	128		930	LP-019-0-SL028-...
19	Self-sealing coupling (female)	BSPP 3/4"	VII			19	46	17	54	100		830	LP-019-0-VR026-...
19	Self-sealing coupling (female)	BSPP 1"	VII			19	46	20	54	103		870	LP-019-0-VR033-...
19	Self-sealing coupling (female)	BSPP 3/4"	I				46	17	54	100		840	LP-019-0-WR026-...
19	Self-sealing coupling (female)	BSPP 1"	I				46	20	54	103		870	LP-019-0-WR033-...
19	Self-sealing coupling (female)	BSPP 3/4"	II				46	19	54	94		890	LP-019-0-WR526-...
19	Self-sealing coupling (female)	BSPP 1"	II				46	23	54	98		880	LP-019-0-WR533-...
19	Thru-type adaptor (male)	19 mm	XI			12		35	32	68.5	32.5	180	LP-019-1-SL019-...
19	Thru-type adaptor (male)	25 mm	XI					40	32	73.5	32.5	190	LP-019-1-SL025-...
19	Thru-type adaptor (male)	BSPP 1/2"	I			13	36	15	40	57.5	32.5	210	LP-019-1-WR021-...
19	Thru-type adaptor (male)	BSPP 3/4"	I				36	17	40	59.5	32.5	220	LP-019-1-WR026-...
19	Thru-type adaptor (male)	BSPP 1"	I				36	20	40	62.5	32.5	260	LP-019-1-WR033-...
19	Thru-type adaptor (male)	BSPP 3/4"	II				36	19	40	57.5	32.5	240	LP-019-1-WR526-...
19	Thru-type adaptor (male)	BSPP 1"	II				41	23	45	61.5	32.5	250	LP-019-1-WR533-...
19	Self-sealing adaptor (male)	M 26 x 1.5	V			15	46	12	54	91	32.5	680	LP-019-2-D1526-...
19	Self-sealing adaptor (male)	M 30 x 1.5	V			19	46	14	54	93	32.5	680	LP-019-2-D1930-...

NB - Nominal bore [mm] A / A1 - Connection SW - Wrench size [mm] T - Thread length [mm] D - Diameter [mm] L - Length [mm] N - Adaptor length [mm] Weight [g]



## Series LP



### Product chart | Quick coupling systems

Self-sealing adaptor / thru-type adaptor marked in blue

NB	Product type	A / A1	De- sign	Ran- ge	Pipe AD	Pipe ID	SW	T	D	L	N	Weight Steel	Material-neutral part number
19	Self-sealing adaptor (male)	M 30 x 1.5	VI			19	46	45	54	124	32.5	770	LP-019-2-DV022-...-
19	Self-sealing adaptor (male)	M 26 x 1.5	III	L	18	16	46	12	54	91	32.5	680	LP-019-2-L1826-...-
19	Self-sealing adaptor (male)	M 30 x 2	III	L	22	20	46	14	54	93	32.5	670	LP-019-2-L2230-...-
19	Self-sealing adaptor (male)	M 30 x 2	III	S	20	16	46	16	54	95	32.5	690	LP-019-2-S2030-...-
19	Self-sealing adaptor (male)	M 36 x 2	III	S	25	20	46	18	54	97	32.5	710	LP-019-2-S2536-...-
19	Self-sealing adaptor (male)	19 mm	XI			13	46	35	54	114	32.5	700	LP-019-2-SL019-...-
19	Self-sealing adaptor (male)	25 mm	XI				46	40	54	119	32.5	710	LP-019-2-SL025-...-
19	Self-sealing adaptor (male)	28 mm	XI				46	45	54	124	32.5	780	LP-019-2-SL028-...-
19	Self-sealing adaptor (male)	BSPP 3/4"	VII			19	46	17	54	96	32.5	690	LP-019-2-VR026-...-
19	Self-sealing adaptor (male)	BSPP 1"	VII			19	46	20	54	99	32.5	720	LP-019-2-VR033-...-
19	Self-sealing adaptor (male)	BSPP 3/4"	I				46	17	54	96	32.5	690	LP-019-2-WR026-...-
19	Self-sealing adaptor (male)	BSPP 1 "	I				46	20	54	99	32.5	720	LP-019-2-WR033-...-
19	Self-sealing adaptor (male)	BSPP 3/4"	II				46	19	54	90	32.5	740	LP-019-2-WR526-...-
19	Self-sealing adaptor (male)	BSPP 1"	II				46	23	54	94	32.5	730	LP-019-2-WR533-...-
32	Self-sealing coupling (female)	M 45 x 1.5	V			32	75	16	82	128		2,720	LP-032-0-D3245-...-
32	Self-sealing coupling (female)	M 52 x 2	III	S	38	32	75	22	82	134		2,770	LP-032-0-S3852-...-
32	Self-sealing coupling (female)	42 mm	XI				75	61	82	178		3,090	LP-032-0-SL042-...-
32	Self-sealing coupling (female)	BSPP 1 1/2"	I				75	22	82	139		2,930	LP-032-0-WR048-...-
32	Self-sealing coupling (female)	BSPP 2"	I				75	26	82	143		2,980	LP-032-0-WR060-...-
32	Self-sealing coupling (female)	BSPP 1 1/2"	II				75	25	82	126		2,890	LP-032-0-WR548-...-
32	Self-sealing coupling (female)	BSPP 2"	II				75	29	82	130		2760	LP-032-0-WR560-...-

NB - Nominal bore [mm] A / A1 - Connection SW - Wrench size [mm] T - Thread length [mm] D - Diameter [mm] L - Length [mm] N - Adaptor length [mm] Weight [g]

**Product chart | Quick coupling systems**

Self-sealing adaptor / thru-type adaptor marked in blue

NB	Product type	A / A1	De-sign	Ran-ge	Pipe AD	Pipe ID	SW	T	D	L	N	Weight Steel	Material-neutral part number
32	Thru-type adaptor (male)	42 mm	XI					61	54	105	39	620	LP-032-1-SL042-...
32	Thru-type adaptor (male)	BSPP 1 1/2"	I				55	22	60	74.5	39	600	LP-032-1-WR048-...
32	Thru-type adaptor (male)	BSPP 2"	I				65	26	72.5	78.5	39	650	LP-032-1-WR060-...
32	Thru-type adaptor (male)	BSPP 1 1/4"	II				55	25	61.9	71	39	610	LP-032-1-WR542-...
32	Thru-type adaptor (male)	BSPP 1 1/2"	II				60	25	67	71	39	640	LP-032-1-WR548-...
32	Thru-type adaptor (male)	BSPP 2"	II				65	29	72.6	75	39	790	LP-032-1-WR560-...
32	Self-sealing adaptor (male)	M 45 x 1.5	V			32	75	16	82	124.5	39	2,220	LP-032-2-D3245-...
32	Self-sealing adaptor (male)	M 52 x 2	III	S	38	32	75	22	82	130.5	39	2,280	LP-032-2-S3852-...
32	Self-sealing adaptor (male)	42 mm	XI				75	61	82	174.5	39	2,610	LP-032-2-SL042-...
32	Self-sealing adaptor (male)	BSPP 1 1/2"	I				75	22	82	135.5	39	2,460	LP-032-2-WR048-...
32	Self-sealing adaptor (male)	BSPP 1"	I				75	26	82	139.5	39	2,500	LP-032-2-WR060-...
32	Self-sealing adaptor (male)	BSPP 1 1/2"	II				75	25	82	122.5	39	2,390	LP-032-2-WR548-...
32	Self-sealing adaptor (male)	BSPP 2"	II				75	29	82	126.5	39	2,260	LP-032-2-WR560-...
32	Thru-type coupling (female)	42 mm	XI				70	61	82	143		2,260	LP-032-4-SL042-...
32	Thru-type coupling (female)	BSPP 1 1/2"	I				70	22	82	109		2,230	LP-032-4-WR048-...
32	Thru-type coupling (female)	BSPP 2"	I				70	26	82	113		2,490	LP-032-4-WR060-...
32	Thru-type coupling (female)	BSPP 1 1/4"	II				70	25	82	89		2,000	LP-032-4-WR542-...
32	Thru-type coupling (female)	BSPP 1 1/2"	II				70	25	82	89		1,930	LP-032-4-WR548-...
32	Thru-type coupling (female)	BSPP 2"	II				70	29	82	89		1,690	LP-032-4-WR560-...
50	Self-sealing coupling (female)	BSPP 2"	I			40	100	26	112	162		5,550	LP-050-0-WR060-...
50	Self-sealing coupling (female)	BSPP 2 1/2"	I				100	30	112	164		5,560	LP-050-0-WR075-...

NB - Nominal bore [mm] A / A1 - Connection SW - Wrench size [mm] T - Thread length [mm] D - Diameter [mm] L - Length [mm] N - Adaptor length [mm] Weight [g]



## Series LP



### Product chart | Quick coupling systems

Self-sealing adaptor / thru-type adaptor marked in blue

NB	Product type	A / A1	De- sign	Ran- ge	Pipe AD	Pipe ID	SW	T	D	L	N	Weight Steel	Material-neutral part number
50	Self-sealing coupling (female)	BSPP 2"	II				100	29	112	158		6,150	LP-050-0-WR560-...
50	Self-sealing coupling (female)	BSPP 2 1/2"	II				100	33	122	167		5,940	LP-050-0-WR575-...
50	Thru-type adaptor (male)	65 mm	XI					75	90	131	46	2,050	LP-050-1-SL065-..
50	Thru-type adaptor (male)	BSPP 2"	I			45	85	26	92	88	46	1,590	LP-050-1-WR060-..
50	Thru-type adaptor (male)	BSPP 2"	II				85	29	92	82	46	1,850	LP-050-1-WR560-..
50	Self-sealing adaptor (male)	BSPP 2"	I				100	26	112	158	46	5,010	LP-050-2-WR060-...
50	Self-sealing adaptor (male)	BSPP 2 1/2"	I				100	30	112	160	46	5,020	LP-050-2-WR075-...
50	Self-sealing adaptor (male)	BSPP 2"	II			40	100	29	112	154	46	5,610	LP-050-2-WR560-...
50	Self-sealing adaptor (male)	BSPP 2 1/2"	II				100	33	112	163	46	5,400	LP-050-2-WR575-...
50	Thru-type coupling (female)	BSPP 2"	I			44	100	26	112	132.5		3,950	LP-050-4-WR060-...
50	Thru-type coupling (female)	BSPP 2 1/2"	I				100	30	112	136.5		4,210	LP-050-4-WR075-...
50	Thru-type coupling (female)	BSPP 2"	II				100	27	112	106.5		3,800	LP-050-4-WR560-...
50	Thru-type coupling (female)	BSPP 2 1/2"	II				100	31	112	106.5		3,640	LP-050-4-WR575-...

NB - Nominal bore [mm] A / A1 - Connection SW - Wrench size [mm] T - Thread length [mm] D - Diameter [mm] L - Length [mm] N - Adaptor length [mm] Weight [g]

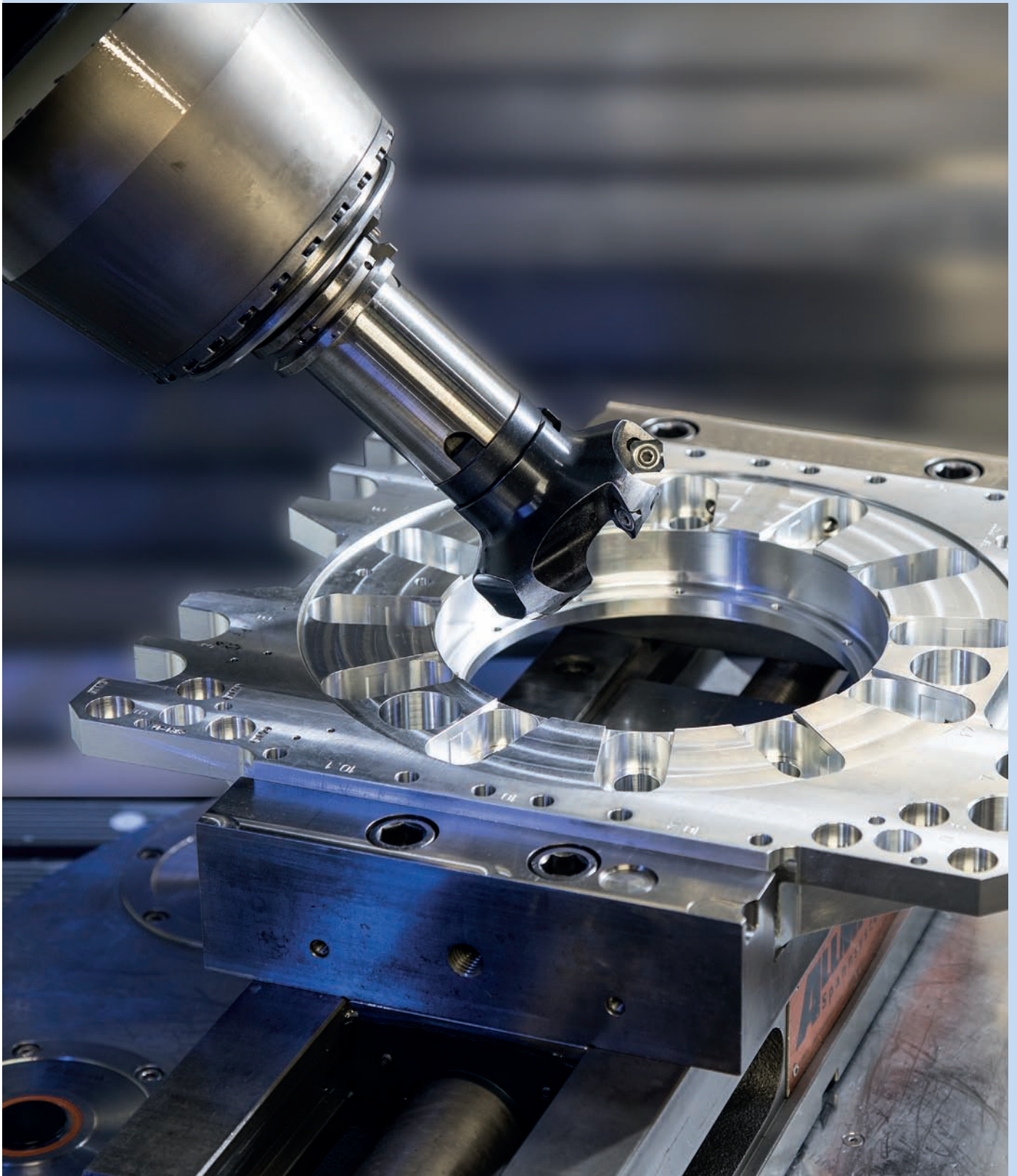







## Series LS

### Technical chart | Quick coupling systems

Nominal bore [mm]	Cv value		Q [m³/h] air 6 bar, 20 °C, Δp = 1 bar		Related Thru-type adaptor (male)  coupled with	p max. permissible static [bar / psi]  WEDISO coupled
	EA	BA	EA	BA		
6	1.71		86.54		LP-006-1 	12 / 174
6	1.90		96.15		LS-E06-1	12 / 174
9	4.32		218.62		SP-009-1	12 / 174
11	5.14		260.12		LS-E11-1	12 / 174
12	7.80		394.73		LP-012-1 	16 / 232
23	25.80		1,305.66		LP-019-1	16 / 232
23	33.60		1,700.39		LS-023-1	16 / 232
38	107.00		5,414.93		LS-038-1	16 / 232

One side self-sealing (EA). Both sides self-sealing (BA). The pressure values are applicable at a temperature of 20°C. Please inquire about other temperature ranges.

Stated maximum permissible operating pressures (p max. permissible static) only apply to materials specified by us and to operation with group II media according to directive 2014/68/EU. Material combinations, optional materials, as well as other media or other temperature ranges can lead to divergent maximum permissible operating pressures and must be requested separately.

Please note that the maximum permissible operating pressure of the connection and quick coupling system must be considered when determining the operating pressure. Our safety instructions must be followed.

◀◀ The **performance diagram** can be found on the front catalogue fold-out page.

A detailed **connection description** can be found on the back catalogue fold-out page. ▶▶

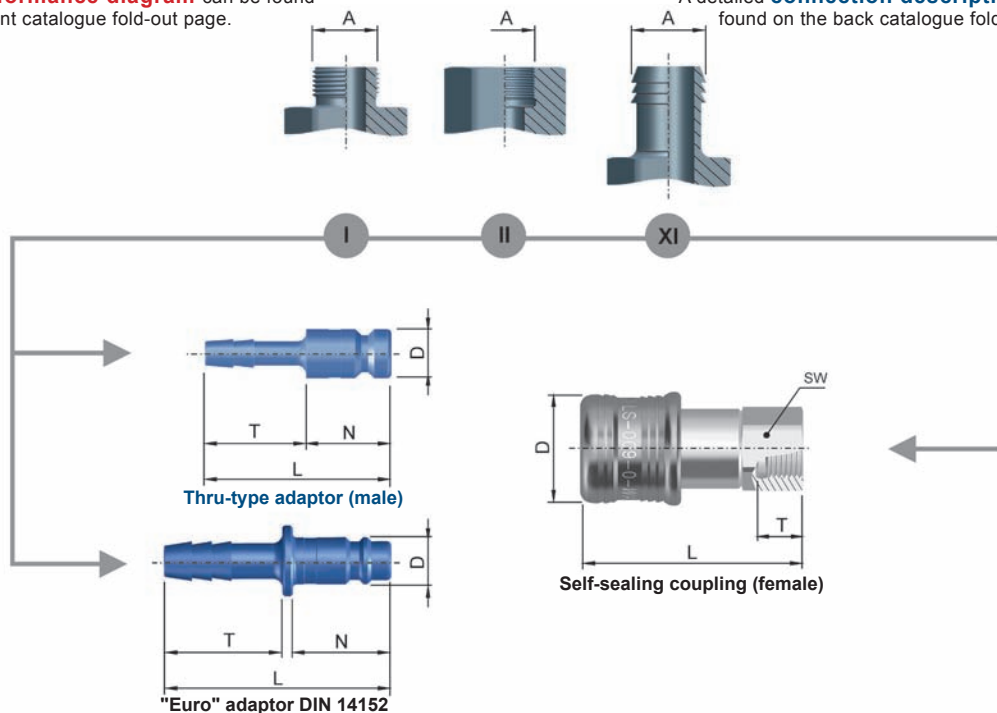





## Series LS

### Features chart | Quick coupling systems

	Product features	WEDISO	Additional options
Standard	<p><b>LS-006</b></p> <ul style="list-style-type: none"> <li>- Can be coupled with adaptor profile LP-006-1 and DIN 14152 (so-called "Euro" adaptor)</li> <li>- Automatic locking (one-hand operation)</li> <li>- Safety unlocking (residual pressure-dependent)</li> </ul> <p><b>LS-009</b></p> <ul style="list-style-type: none"> <li>- Can be coupled with adaptor profile SP-009-1</li> </ul> <p><b>LS-E11</b></p> <ul style="list-style-type: none"> <li>- Can be coupled with adaptor profile DIN 14152 (so-called "Euro" adaptor)</li> </ul>	<p><b>LS-006/009</b></p> <p>coupling housing: Chemically nickel-plated steel Locking sleeve: Passivated brass Connecting pieces: Galvanised steel Seal: NBR</p> <p><b>LS-012/023/038</b></p> <p>Coupling housing: Nickel-plated brass Connecting link disc: Nickel-plated brass Locking sleeve: Hard-coated aluminium Seal: NBR</p>	FL = Free from enamel flow-disturbing substances
Optional	<p><b>LS-012</b></p> <ul style="list-style-type: none"> <li>- Height and width of the coupling with lever: 83 mm and 98 mm</li> </ul> <p><b>LS-023</b></p> <ul style="list-style-type: none"> <li>- Height and width of the coupling with lever: 107 mm and 135 mm</li> </ul> <p><b>LS-038</b></p> <ul style="list-style-type: none"> <li>- Height and width of the coupling with lever: 150 mm and 170 mm</li> </ul>	Other materials on request	

Fully meets the safety requirements in accordance with DIN EN ISO 4414 „Pneumatic fluid power: - General rules and safety requirements for systems and their components“. This safety is achieved by a pressure-dependent two-step disconnection (avoiding the whip effect).

For example, a complete part number looks like this:

**LS-006-0-SL009-WEDISO-Additional options-Y./-Z..**

### Product chart | Quick coupling systems

Thru-type adaptor marked in blue



NB	Product type	A	De- sign	Pipe ID	SW	T	D	L	N	Weight WEDISO	Material-neutral part number
6	Self-sealing coupling (female)	9 mm	XI		24	30	37	91.5		265	LS-006-0-SL009-.....Z01

NB - Nominal bore [mm] A - Connection SW - Wrench size [mm] T - Thread length [mm] D - Diameter [mm] L - Length [mm] N - Adaptor length [mm] Weight [g]



## Series LS

### Product chart | Quick coupling systems

Thru-type adaptor marked in blue

NB	Product type	A	De- sign	Pipe ID	SW	T	D	L	N	Weight WEDISO	Material-neutral part number
6	Self-sealing coupling (female)	11 mm	XI		24	30	37	91.5		265	LS-006-0-SL011-....-Z01
6	Self-sealing coupling (female)	13 mm	XI		24	30	37	91.5		275	LS-006-0-SL013-....-Z01
6	Self-sealing coupling (female)	BSPP 1/4"	I		24	11	37	72.5		255	LS-006-0-WR013-....-Z01
6	Self-sealing coupling (female)	BSPP 3/8"	I		24	12	37	73.5		265	LS-006-0-WR017-....-Z01
6	Self-sealing coupling (female)	BSPP 1/2"	I		24	15	37	76.5		275	LS-006-0-WR021-....-Z01
6	Self-sealing coupling (female)	BSPP 1/4"	II		24	13	37	74.5		275	LS-006-0-WR513-....-Z01
6	Self-sealing coupling (female)	BSPP 3/8"	II		24	14	37	75.5		275	LS-006-0-WR517-....-Z01
6	Self-sealing coupling (female)	BSPP 1/2"	II		27	17	37	78.5		295	LS-006-0-WR521-....-Z01
6	Thru-type adaptor (male)	9 mm	XI			23	12	46.1	20	16	LS-E06-1-SL009-..
6	Thru-type adaptor (male)	11 mm	XI			25.1	12	48.2	20	18	LS-E06-1-SL011-..
6	Thru-type adaptor (male)	13 mm	XI			25	15	48.3	20	20	LS-E06-1-SL013-..
6	Thru-type adaptor (male)	BSPP 1/4"	I		14	11.5	16.2	37.1	20	21	LS-E06-1-WR013-..
6	Thru-type adaptor (male)	BSPP 3/8"	I		19	8.6	21.1	34	20	27.5	LS-E06-1-WR017-..
6	Thru-type adaptor (male)	BSPP 1/4"	II		17	7.5	19.5	33	20	25.5	LS-E06-1-WR513-..
9	Self-sealing coupling (female)	13 mm	XI		25	30	40.6	94.4		298	LS-009-0-SL013-....
9	Self-sealing coupling (female)	BSPP 1/2"	I		25	15	40.6	82.6		300	LS-009-0-WR021-....
9	Self-sealing coupling (female)	BSPP 1/2"	II		27	17	40.6	79.6		315	LS-009-0-WR521-....
9	Self-sealing coupling (female)	BSPP 3/4"	II		32	19	40.6	81.6		334	LS-009-0-WR526-....
11	Self-sealing coupling (female)	13 mm	XI	9	25	30	40.6	93		293	LS-E11-0-SL013-....
11	Self-sealing coupling (female)	BSPP 1/2"	I		25	15	40.6	81		290	LS-E11-0-WR021-....

NB - Nominal bore [mm] A - Connection SW - Wrench size [mm] T - Thread length [mm] D - Diameter [mm] L - Length [mm] N - Adaptor length [mm] Weight [g]



## Series LS

### Product chart | Quick coupling systems

Thru-type adaptor marked in blue

NB	Product type	A	De- sign	Pipe ID	SW	T	D	L	N	Weight WEDISO	Material-neutral part number
11	Self-sealing coupling (female)	BSPP 1/2"	II		27	17	40.6	78		305	LS-E11-0-WR521-....
11	Self-sealing coupling (female)	BSPP 3/4"	II		32	19	40.6	80		324	LS-E11-0-WR526-....
11	Thru-type adaptor (male)	13 mm	XI	10		25	15	48	21.4	29	LS-E11-1-SL013-..
11	Thru-type adaptor (male)	BSPP 3/8"	I	9,8	25	12	27.8	43.4	21.4	32	LS-E11-1-WR017-..
11	Thru-type adaptor (male)	BSPP 1/2"	I		25	15	27.8	46.4	21.4	53.5	LS-E11-1-WR021-..
11	Thru-type adaptor (male)	BSPP 1/2"	II		27	17	30	43.4	21.4	42	LS-E11-1-WR521-..
12	Self-sealing coupling (female)	BSPP 1/2"	II		25	17.5	58	134		1,011	LS-012-0-WR521-....-Z01
23	Self-sealing coupling (female)	BSPP 1"	II		40	21	75.8	170.4		2,695	LS-023-0-WR533-....-Z02
23	Thru-type adaptor (male)	25 mm	XI	19		40	48	81	36	230	LS-023-1-SL025-..
23	Thru-type adaptor (male)	BSPP 1"	I		36	20	40	66	36	219	LS-023-1-WR033-..
38	Self-sealing coupling (female)	BSPP 1 1/2"	II		55	43.25	105	218		11,438	LS-038-0-WR548-....-Z03
38	Thru-type adaptor (male)	53 mm	XI			70	63	129	53.9	1,040	LS-038-1-SL053-..
38	Thru-type adaptor (male)	BSPP 1 1/2"	I		55	22	61.3	93.9	53.9	641	LS-038-1-WR048-..

NB - Nominal bore [mm] A - Connection SW - Wrench size [mm] T - Thread length [mm] D - Diameter [mm] L - Length [mm] N - Adaptor length [mm] Weight [g]



## Series LT

### Technical chart | Quick coupling systems

Nominal bore [mm]	Cv value		Q [m³/h] air 6 bar, 20 °C, Δp = 1 bar		Related Thru-type adaptor (male)  coupled with	p max. permissible static [bar / psi]  WEDISO coupled
	EA	BA	EA	BA		
6	1.71		86.54		LP-006-1 	12 / 174
6	1.90		96.15		LS-E06-1	12 / 174
9	4.32		218.62		SP-009-1	12 / 174
11	5.14		260.12		LS-E11-1	12 / 174

One side self-sealing (EA). Both sides self-sealing (BA). The pressure values are applicable at a temperature of 20°C. Please inquire about other temperature ranges.

Stated maximum permissible operating pressures (p max. permissible static) only apply to materials specified by us and to operation with group II media according to directive 2014/68/EU. Material combinations, optional materials, as well as other media or other temperature ranges can lead to divergent maximum permissible operating pressures and must be requested separately.

Please note that the maximum permissible operating pressure of the connection and quick coupling system must be considered when determining the operating pressure. Our safety instructions must be followed.

◀◀ The **performance diagram** can be found on the front catalogue fold-out page.

A detailed **connection description** can be found on the back catalogue fold-out page. ▶▶

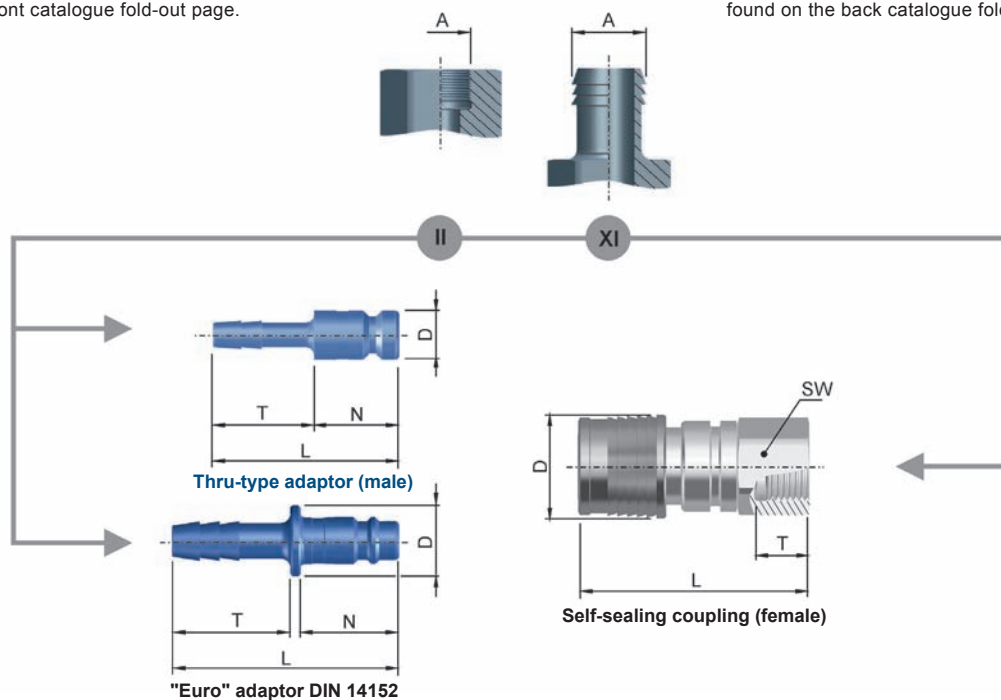



## Series LT

### Features chart | Quick coupling systems

	Product features	WEDISO	Additional options
Standard	<ul style="list-style-type: none"> <li>- Compact design</li> <li>- Extremely low weight</li> </ul> <p><b>LT-006</b></p> <ul style="list-style-type: none"> <li>- Can be coupled with adaptor profile LP-006-1 and DIN 14152 (so-called "Euro" adaptor)</li> </ul> <p><b>LT-009</b></p> <ul style="list-style-type: none"> <li>- Can be coupled with adaptor profile SP-009-1</li> </ul>	<p><b>Coupling housing</b> Hard-coated aluminium</p> <p><b>Locking sleeve</b> Plastic or anodised aluminium End plug AAAA: Hard-coated aluminium, anodised and plastic Connecting piece AAAF: Hard-coated aluminium</p> <p><b>Seals</b> NBR</p>	FL = Free from enamel flow-disturbing substances
Optional	<p><b>LT-E11</b></p> <ul style="list-style-type: none"> <li>- Can be coupled with adaptor profile DIN 14152 (so-called "Euro" adaptor)</li> </ul>	Other materials on request	

For example, a complete part number looks like this:

**LT-006-0-WR513-WEDISO-Additional options-Y./-Z..**

### Product chart | Quick coupling systems



NB	Product type	A	De-sign	Pipe ID	SW	T	D	L	N	Weight WEDISO	Material-neutral part number
6	Self-sealing coupling (female)	BSPP 1/4"	II		22	11	28	61		62	LT-006-0-WR513-.....-Z07
6	Self-sealing coupling (female)	BSPP 3/8"	II		22	11	28	62		64	LT-006-0-WR517-.....-Z07
6	Self-sealing coupling (female)	9 mm	XI		22	13	28	78		50	LT-006-0-XX009-.....-Z07
6	Self-sealing coupling (female)	11 mm	XI		22	13	28	78		51	LT-006-0-XX011-.....-Z07

NB - Nominal bore [mm] A - Connection SW - Wrench size [mm] T - Thread length [mm] D - Diameter [mm] L - Length [mm] N - Adaptor length [mm] Weight [g]



## Series LT

### Product chart | Quick coupling systems

NB	Product type	A	De- sign	Pipe ID	SW	T	D	L	N	Weight WEDISO	Material-neutral part number
9	Self-sealing coupling (female)	BSPP 1/2"	II		27	17	30	71		90	LT-009-0-WR521-....
9	Self-sealing coupling (female)	BSPP 3/4"	II		32	19	30	73		95	LT-009-0-WR526-....
9	Self-sealing coupling (female)	11 mm	XI	8	25	30	30	86		65	LT-009-0-XX011-....
9	Self-sealing coupling (female)	13 mm	XI		25	30	30	86		69	LT-009-0-XX013-....
11	Self-sealing coupling (female)	BSPP 1/2"	II		27	17	30	77.5		95	LT-E11-0-WR521-....
11	Self-sealing coupling (female)	BSPP 3/4"	II		32	19	30	79.5		100	LT-E11-0-WR526-....
11	Self-sealing coupling (female)	11 mm	XI	8	25	30	30	92.5		71	LT-E11-0-XX011-....
11	Self-sealing coupling (female)	13 mm	XI		25	30	30	92.5		75	LT-E11-0-XX013-....

**NB** - Nominal bore [mm]   **A** - Connection   **SW** - Wrench size [mm]   **T** - Thread length [mm]   **D** - Diameter [mm]   **L** - Length [mm]   **N** - Adaptor length [mm]   Weight [g]



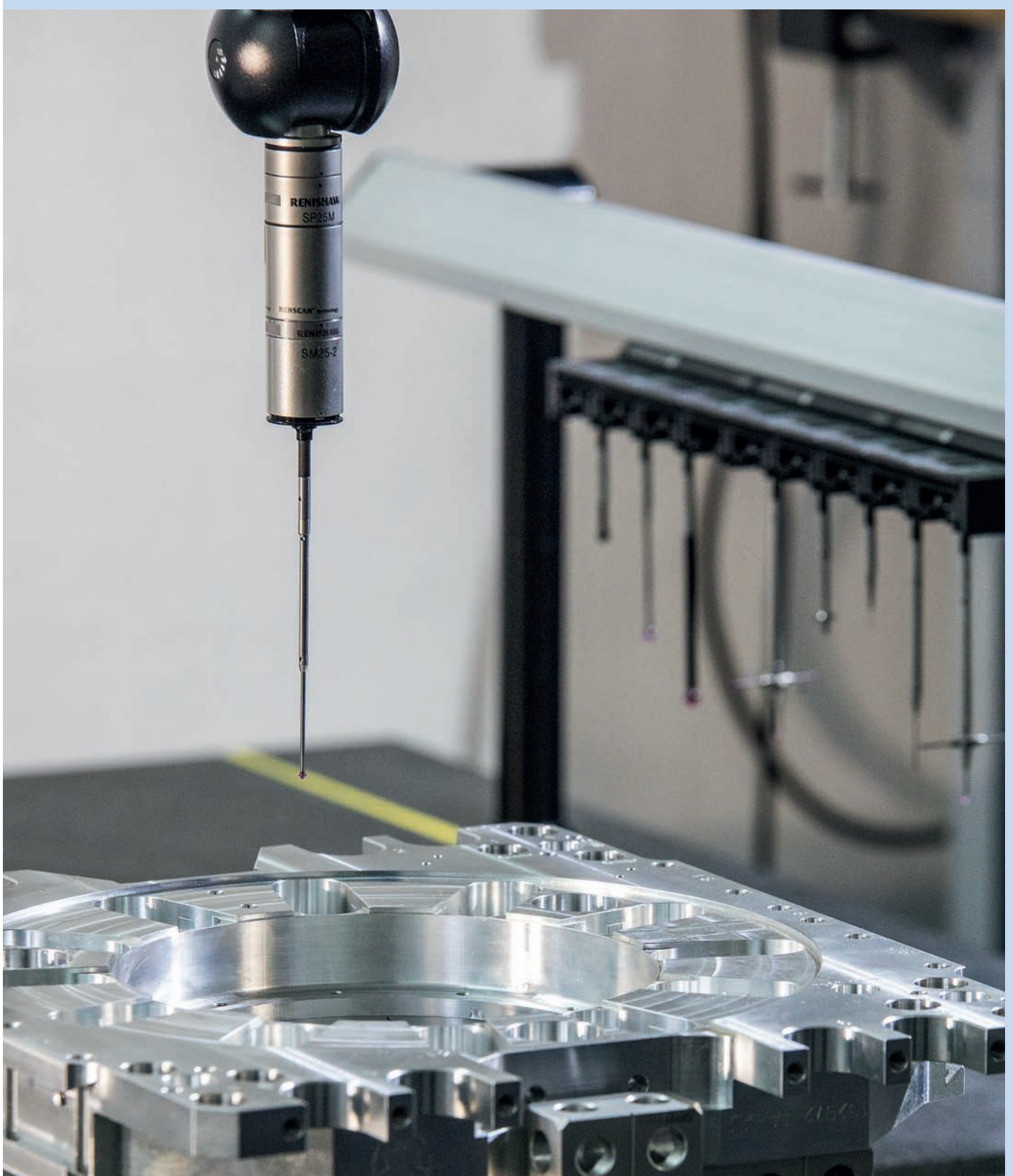



## Series LV

### Technical chart | Quick coupling systems

Nominal bore [mm]	Cv value		Q [L/min] water 20 °C, Δp = 1 bar		Q [m³/h] air 6 bar, 20 °C, Δp = 1 bar		p max. permissible static [bar / psi]	
	EA	BA	EA	BA	EA	BA	Brass	Stainless steel
							coupled	coupled
4		0.30		4.28		15.18	60 / 870	100 / 1,450
9		2.02		28.85		15.18	40 / 580	

One side self-sealing (EA). Both sides self-sealing (BA). The pressure values are applicable at a temperature of 20°C. Please inquire about other temperature ranges.

Stated maximum permissible operating pressures (p max. permissible static) only apply to materials specified by us and to operation with group II media according to directive 2014/68/EU. Material combinations, optional materials, as well as other media or other temperature ranges can lead to divergent maximum permissible operating pressures and must be requested separately.

Please note that the maximum permissible operating pressure of the connection and quick coupling system must be considered when determining the operating pressure. Our safety instructions must be followed.

◀◀ The **performance diagram** can be found on the front catalogue fold-out page.

A detailed **connection description** can be found on the back catalogue fold-out page. ▶▶

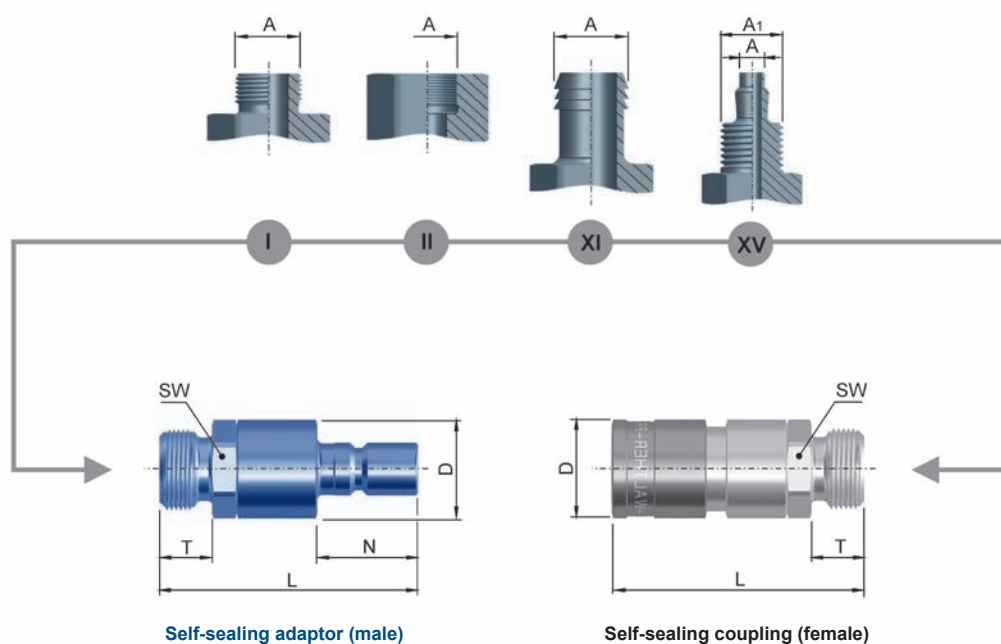



## Series LV

### Features chart | Quick coupling systems

	Product features	Materials	Seals	Additional options
Standard	- Non-squirting - Extended version	21 = Brass passivated  <b>LV-004</b> 01 = Stainless steel 1.4404/1.4571 or similar	1 = NBR 2 = FKM 4 = EPDM	BB = 3.1 production FD = FDA-compliant FF = Oil- and grease-free FL = Free from enamel flow-disturbing substances GL = Smooth design GX = Smooth design with key flat-locking piece
Optional			FFKM	

**Attention:** Self-sealing coupling + OV  $\triangleq$  Product type Thru-type coupling; Self-sealing adaptor + OV  $\triangleq$  Product type Thru-type adaptor

For example, a complete part number looks like this:

**LV-004-0-SL004-Material-SeaL-Additional options-Y../-Z..**

### Product chart | Quick coupling systems

Self-sealing adaptor marked in blue



NB	Product type	A / A1	De- sign	Pipe ID	SW	T	D	L	N	Weight Brass	Material-neutral part number
4	Self-sealing coupling (female)	4 mm	XI	3	14	18	18	58.5		55	LV-004-0-SL004-...-
4	Self-sealing coupling (female)	6 mm	XI		14	25	18	65.5		55	LV-004-0-SL006-...-
4	Self-sealing coupling (female)	OD 6 ID 4 mm M 10 x 1	XV	3	14	16	18	56.5		65	LV-004-0-SW004-...-
4	Self-sealing coupling (female)	BSPP 1/8"	I		14	8	18	50.5		55	LV-004-0-WR010-...-
4	Self-sealing coupling (female)	BSPP 1/4"	I		14	11	18	51.5		60	LV-004-0-WR013-...-

NB - Nominal bore [mm] A / A1 - Connection SW - Wrench size [mm] T - Thread length [mm] D - Diameter [mm] L - Length [mm] N - Adaptor length [mm] Weight [g]



## Series LV

### Product chart | Quick coupling systems

Self-sealing adaptor marked in blue

NB	Product type	A / A1	De- sign	Pipe ID	SW	T	D	L	N	Weight Brass	Material-neutral part number
4	Self-sealing coupling (female)	BSPP 1/8"	II		14	9	18	50.5		60	LV-004-0-WR510-...
4	Self-sealing adaptor (male)	4 mm	XI	3	14	18	18	58	21	35	LV-004-2-SL004-...
4	Self-sealing adaptor (male)	6 mm	XI		14	25	18	65	21	38	LV-004-2-SL006-...
4	Self-sealing adaptor (male)	OD 6 ID 4 mm M 10 x 1	XV	3	14	16	18	56	21	46	LV-004-2-SW004-...
4	Self-sealing adaptor (male)	BSPP 1/8"	I		14	8	18	50	21	38	LV-004-2-WR010-...
4	Self-sealing adaptor (male)	BSPP 1/4"	I		14	11	18	51	21	43	LV-004-2-WR013-...
4	Self-sealing adaptor (male)	BSPP 1/8"	II		14	9	18	50	21	42	LV-004-2-WR510-...
9	Self-sealing coupling (female)	13 mm	XI		25	30	28	87		199	LV-009-0-SL013-...
9	Self-sealing coupling (female)	BSPP 3/8"	I		25	12	28	72		203	LV-009-0-WR017-...
9	Self-sealing coupling (female)	BSPP 1/2"	I		25	15	28	72		202	LV-009-0-WR021-...
9	Self-sealing coupling (female)	BSPP 1/2"	II		27	17	28	72		215	LV-009-0-WR521-...
9	Self-sealing adaptor (male)	13 mm	XI		25	30	28	88.4	28.5	152	LV-009-2-SL013-...
9	Self-sealing adaptor (male)	BSPP 3/8"	I		25	12	28	73.4	28.5	156	LV-009-2-WR017-...
9	Self-sealing adaptor (male)	BSPP 1/2"	I		25	15	28	73.4	28.5	155	LV-009-2-WR021-...
9	Self-sealing adaptor (male)	BSPP 1/2"	II		27	17	28	73.4	28.5	168	LV-009-2-WR521-...

NB - Nominal bore [mm] A / A1 - Connection SW - Wrench size [mm] T - Thread length [mm] D - Diameter [mm] L - Length [mm] N - Adaptor length [mm] Weight [g]



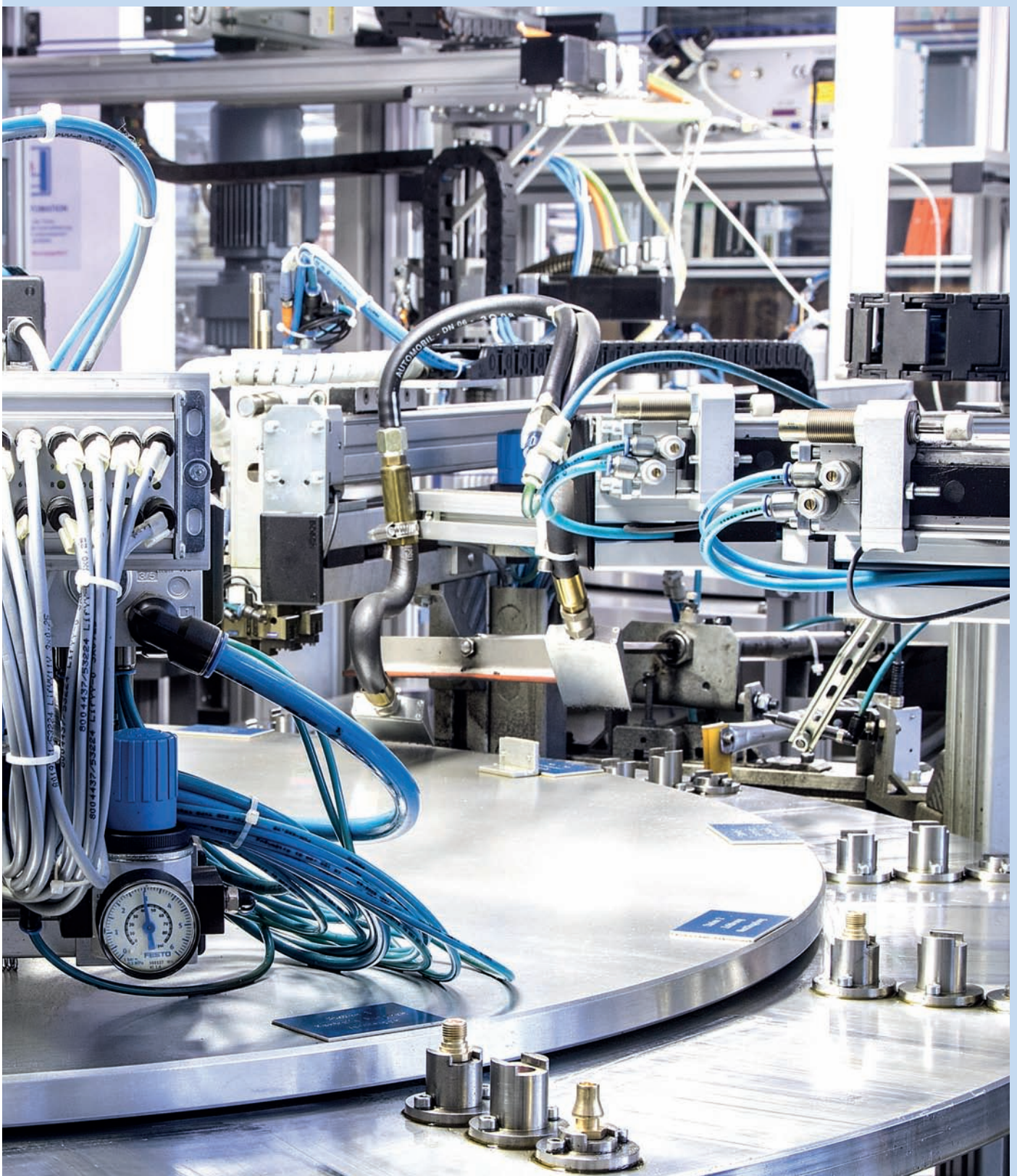



## Series SP

### Technical chart | Quick coupling systems

Nominal bore [mm]	Cv value		Q [L/min] water 20 °C, Δp = 1 bar		Q [m³/h] air 6 bar, 20 °C, Δp = 1 bar		p max. permissible static [bar / psi]		
	EA	BA	EA	BA	EA	BA	Steel	Brass	Stainless steel
							coupled	coupled	coupled
6	1.10	0.77	15.71	11.00	55.67	38.97	120 / 1,740	60 / 870	100 / 1,450
9	2.41	2.10	34.42	29.99	121.96	106.27	100 / 1,450	40 / 580	80 / 1,160

One side self-sealing (EA). Both sides self-sealing (BA). The pressure values are applicable at a temperature of 20°C. Please inquire about other temperature ranges.

Stated maximum permissible operating pressures (p max. permissible static) only apply to materials specified by us and to operation with group II media according to directive 2014/68/EU. Material combinations, optional materials, as well as other media or other temperature ranges can lead to divergent maximum permissible operating pressures and must be requested separately.

Please note that the maximum permissible operating pressure of the connection and quick coupling system must be considered when determining the operating pressure. Our safety instructions must be followed.

◀◀ The **performance diagram** can be found on the front catalogue fold-out page.

A detailed **connection description** can be found on the back catalogue fold-out page. ▶▶

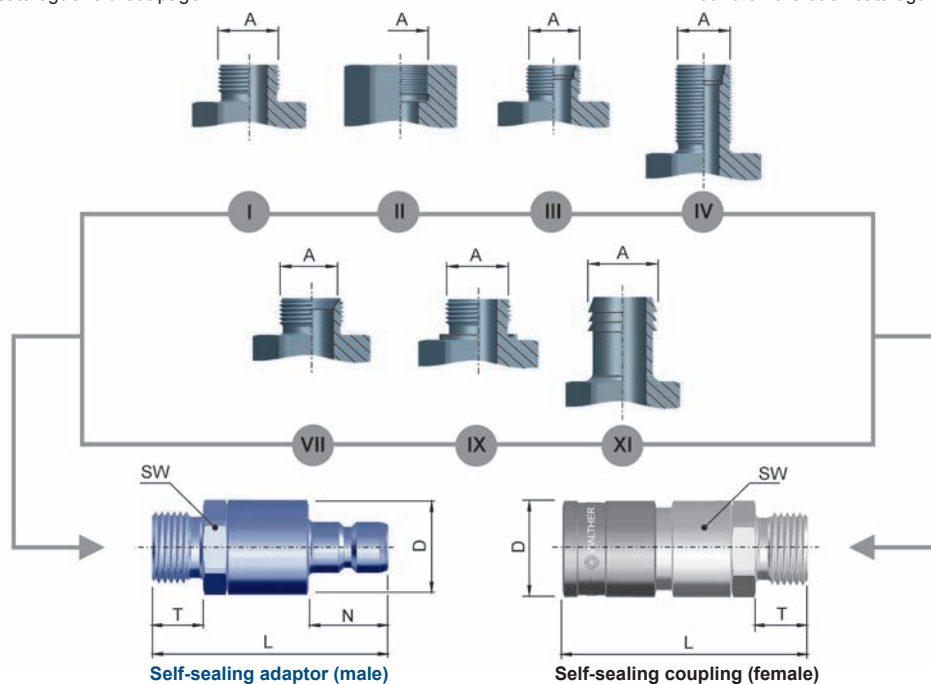





## Series SP

### Features chart | Quick coupling systems

	Product features	Materials	Seals	Additional options
Standard	- Slender design	01 = Stainless steel 1.4404/1.4571 or similar 11 = Steel zinc plated 21 = Brass passivated 22 = Brass chrome plated	1 = NBR 2 = FKM 4 = EPDM	BB = 3.1 production FD = FDA-compliant FF = Oil- and grease-free GL = Smooth design GX = Smooth design with width flat end connection OV = Without valve
Optional		13 = Steel chemically nickel plated 24 = Brass chemically nickel plated	FFKM	

**Attention:** Self-sealing coupling + OV  $\hat{=}$  Product type Thru-type coupling; Self-sealing adaptor + OV  $\hat{=}$  Product type Thru-type adaptor

For example, a complete part number looks like this:

**SP-006-0-D0614-Material-Seal-Additional options-Y./-Z..**

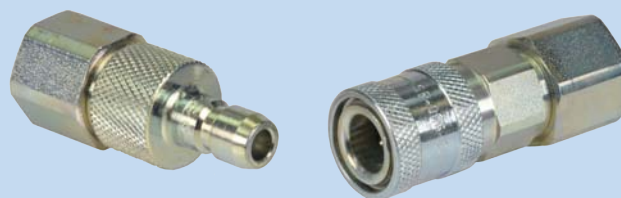

### Product chart | Quick coupling systems

Self-sealing adaptor / thru-type adaptor marked in blue

NB	Product type	A	De- sign	Ran- ge	Pipe AD	Pipe ID	SW	T	D	L	N	Weight Steel	Material-neutral part number
6	Self-sealing coupling (female)	M 12 x 1.5	III	L	6	4	19	10	22	57		85	SP-006-0-L0612-...
6	Self-sealing coupling (female)	M 14 x 1.5	III	L	8	6	19	10	22	57		85	SP-006-0-L0814-...
6	Self-sealing coupling (female)	M 16 x 1.5	III	L	10	8	19	11	22	58		90	SP-006-0-L1016-...
6	Self-sealing coupling (female)	M 18 x 1.5	III	L	12	10	19	11	22	58		90	SP-006-0-L1218-...
6	Self-sealing coupling (female)	M 14 x 1.5	IV	L	8	6	19	32	22	79		100	SP-006-0-LV008-...

NB - Nominal bore [mm] A - Connection SW - Wrench size [mm] T - Thread length [mm] D - Diameter [mm] L - Length [mm] N - Adaptor length [mm] Weight [g]



## Series SP

### Product chart | Quick coupling systems

Self-sealing adaptor / thru-type adaptor marked in blue

NB	Product type	A	De- sign	Ran- ge	Pipe AD	Pipe ID	SW	T	D	L	N	Weight Steel	Material-neutral part number
6	Self-sealing coupling (female)	M 16 x 1.5	III	S	8	4	19	12	22	59		90	SP-006-0-S0816-...
6	Self-sealing coupling (female)	M 18 x 1.5	III	S	10	6	19	12	22	59		95	SP-006-0-S1018-...
6	Self-sealing coupling (female)	6 mm	XI			4	19	25	22	72		85	SP-006-0-SL006-...
6	Self-sealing coupling (female)	9 mm	XI				19	30	22	77		90	SP-006-0-SL009-...
6	Self-sealing coupling (female)	11 mm	XI				19	30	22	77		95	SP-006-0-SL011-...
6	Self-sealing coupling (female)	13 mm	XI				19	30	22	77		110	SP-006-0-SL013-...
6	Self-sealing coupling (female)	BSPP 3/8"	VII			6	19	12	22	59		95	SP-006-0-VR017-...
6	Self-sealing coupling (female)	BSPP 3/8"	IX				27	12	22	64		130	SP-006-0-WE017-...
6	Self-sealing coupling (female)	BSPP 1/4"	I				19	11	22	58		90	SP-006-0-WR013-...
6	Self-sealing coupling (female)	BSPP 3/8"	I				19	12	22	59		95	SP-006-0-WR017-...
6	Self-sealing coupling (female)	BSPP 1/2"	I				22	15	22	62		120	SP-006-0-WR021-...
6	Self-sealing coupling (female)	BSPP 1/4"	II				19	13	22	57		95	SP-006-0-WR513-...
6	Self-sealing coupling (female)	BSPP 3/8"	II				22	14	22	58		100	SP-006-0-WR517-...
6	Self-sealing coupling (female)	M 16 x 1.5	IV	L	10	8	19	32	22	79		110	SP-006-0-XX211-...
6	Thru-type adaptor (male)	6 mm	XI			4			11	46	20	13	SP-006-1-SL006-..
6	Thru-type adaptor (male)	9 mm	XI						11	51	20	18	SP-006-1-SL009-..
6	Thru-type adaptor (male)	BSPP 1/8"	I			4	14	8	15.5	34	20	20	SP-006-1-WR010-..
6	Thru-type adaptor (male)	BSPP 1/4"	I				14	11	15.5	37	20	23	SP-006-1-WR013-..
6	Thru-type adaptor (male)	BSPP 3/8"	I				19	12	21.9	38	20	37	SP-006-1-WR017-..
6	Thru-type adaptor (male)	BSPP 1/4"	II				17	13	19.6	36	20	26	SP-006-1-WR513-..
6	Thru-type adaptor (male)	BSPP 3/8"	II				22	14	24	37	20	40	SP-006-1-WR517-..

NB - Nominal bore [mm] A - Connection SW - Wrench size [mm] T - Thread length [mm] D - Diameter [mm] L - Length [mm] N - Adaptor length [mm] Weight [g]



## Series SP

### Product chart | Quick coupling systems

Self-sealing adaptor / thru-type adaptor marked in blue

NB	Product type	A	De- sign	Ran- ge	Pipe AD	Pipe ID	SW	T	D	L	N	Weight Steel	Material-neutral part number
6	Self-sealing adaptor (male)	M 12 x 1.5	III	L	6	4	19	10	22	55	20	70	SP-006-2-L0612-...
6	Self-sealing adaptor (male)	M 14 x 1.5	III	L	8	6	19	10	22	55	20	70	SP-006-2-L0814-...
6	Self-sealing adaptor (male)	M 16 x 1.5	III	L	10	8	19	11	22	56	20	70	SP-006-2-L1016-...
6	Self-sealing adaptor (male)	M 18 x 1.5	III	L	12	10	19	11	22	56	20	70	SP-006-2-L1218-...
6	Self-sealing adaptor (male)	M 14 x 1.5	IV	L	8	6	19	32	22	77	20	85	SP-006-2-LV008-...
6	Self-sealing adaptor (male)	M 16 x 1.5	III	S	8	4	19	12	22	57	20	75	SP-006-2-S0816-...
6	Self-sealing adaptor (male)	M 18 x 1.5	III	S	10	6	19	12	22	57	20	75	SP-006-2-S1018-...
6	Self-sealing adaptor (male)	6 mm	XI			4	19	25	22	70	20	70	SP-006-2-SL006-...
6	Self-sealing adaptor (male)	9 mm	XI				19	30	22	75	20	70	SP-006-2-SL009-...
6	Self-sealing adaptor (male)	11 mm	XI				19	30	22	75	20	80	SP-006-2-SL011-...
6	Self-sealing adaptor (male)	13 mm	XI				19	30	22	75	20	90	SP-006-2-SL013-...
6	Self-sealing adaptor (male)	BSPP 3/8"	VII			6	19	12	22	57	20	75	SP-006-2-VR017-...
6	Self-sealing adaptor (male)	BSPP 3/8"	IX				27	12	22	62	20	110	SP-006-2-WE017-...
6	Self-sealing adaptor (male)	BSPP 1/4"	I				19	11	22	56	20	70	SP-006-2-WR013-...
6	Self-sealing adaptor (male)	BSPP 3/8"	I				19	12	22	57	20	75	SP-006-2-WR017-...
6	Self-sealing adaptor (male)	BSPP 1/2"	I				22	15	22	60	20	100	SP-006-2-WR021-...
6	Self-sealing adaptor (male)	BSPP 1/4"	II				19	13	22	55	20	75	SP-006-2-WR513-...
6	Self-sealing adaptor (male)	BSPP 3/8"	II				22	14	22	56	20	80	SP-006-2-WR517-...
6	Self-sealing adaptor (male)	M 16 x 1.5	IV	L	10	8	19	32	22	77	20	95	SP-006-2-XX211-...
9	Self-sealing coupling (female)	13 mm	XI				25	30	28	86		180	SP-009-0-SL013-...

NB - Nominal bore [mm] A - Connection SW - Wrench size [mm] T - Thread length [mm] D - Diameter [mm] L - Length [mm] N - Adaptor length [mm] Weight [g]



## Series SP

### Product chart | Quick coupling systems

Self-sealing adaptor / thru-type adaptor marked in blue

NB	Product type	A	De- sign	Ran- ge	Pipe AD	Pipe ID	SW	T	D	L	N	Weight Steel	Material-neutral part number
9	Self-sealing coupling (female)	BSPP 3/8"	I				25	12	28	71		180	SP-009-0-WR017-...
9	Self-sealing coupling (female)	BSPP 1/2"	I				25	15	28	71		190	SP-009-0-WR021-...
9	Self-sealing coupling (female)	BSPP 1/2"	II				27	17	28	71		200	SP-009-0-WR521-...
9	Thru-type adaptor (male)	13 mm	XI					30	15	55	23.5	37	SP-009-1-SL013-..
9	Thru-type adaptor (male)	BSPP 3/8"	I				19	12	21.9	41.5	23.5	40	SP-009-1-WR017-..
9	Thru-type adaptor (male)	BSPP 1/2"	I				22	15	24	46.5	23.5	60	SP-009-1-WR021-..
9	Thru-type adaptor (male)	BSPP 1/2"	II				27	17	30	45	23.5	75	SP-009-1-WR521-..
9	Self-sealing adaptor (male)	13 mm	XI				25	30	28	84.5	23.5	130	SP-009-2-SL013-... -Z02
9	Self-sealing adaptor (male)	BSPP 3/8"	I				25	12	28	69.5	23.5	120	SP-009-2-WR017-... -Z02
9	Self-sealing adaptor (male)	BSPP 1/2"	I				25	15	28	69.5	23.5	130	SP-009-2-WR021-... -Z02
9	Self-sealing adaptor (male)	BSPP 1/2"	II				27	17	28	69.5	23.5	140	SP-009-2-WR521-... -Z02

NB - Nominal bore [mm] A - Connection SW - Wrench size [mm] T - Thread length [mm] D - Diameter [mm] L - Length [mm] N - Adaptor length [mm] Weight [g]

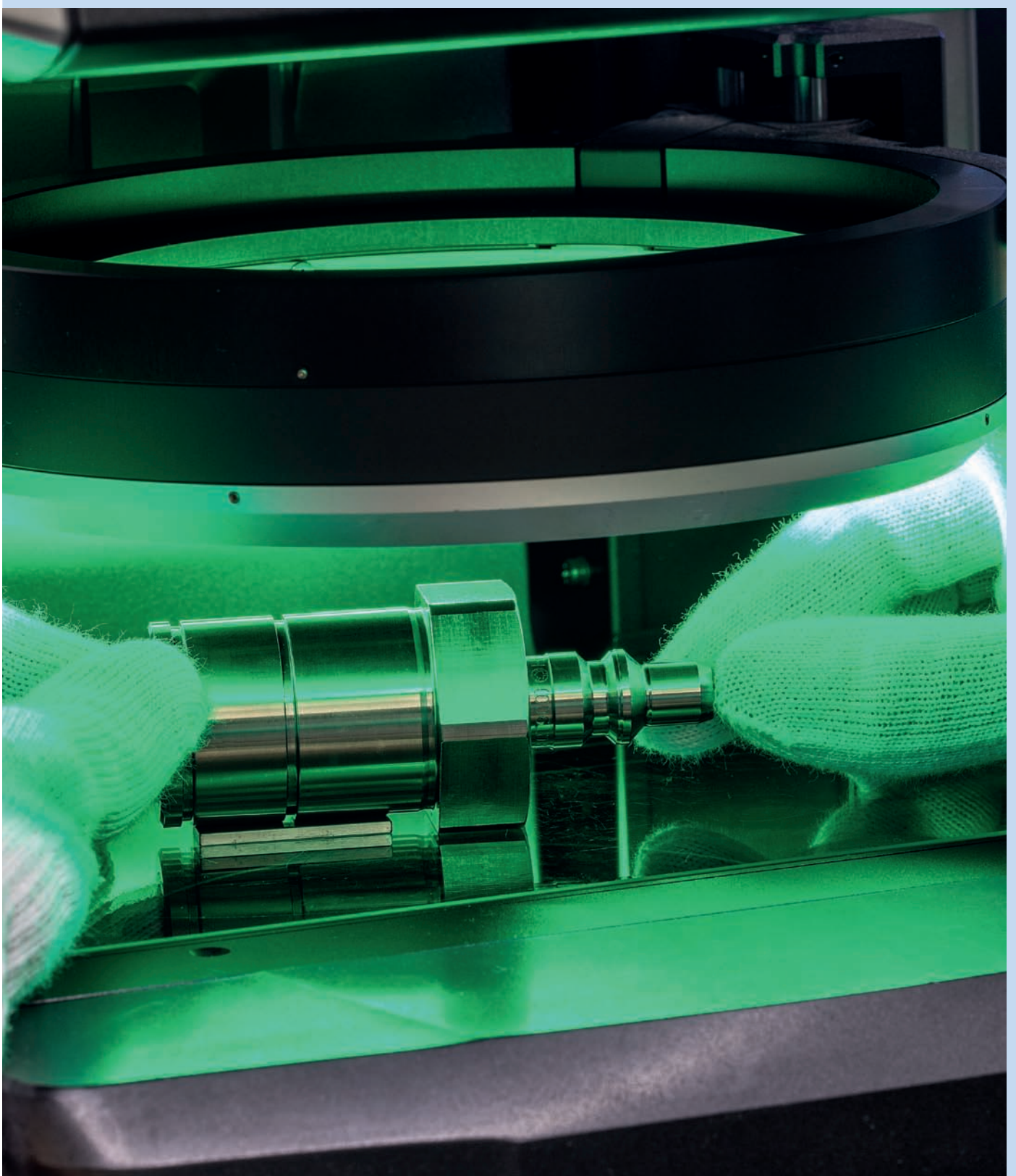



# Series UF



## Technical chart | Quick coupling systems

Nominal bore [mm]	Cv value		Q [L/min] water 20 °C, Δp = 1 bar		Q [m³/h] air 6 bar, 20 °C, Δp = 1 bar		p max. permissible static [bar / psi]	
	EA	BA	EA	BA	EA	BA	Brass	Stainless steel
							coupled	coupled
6	1.10	0.77	15.71	11.00	55.67	38.97	40 / 580	40 / 580
7	1.40	1.07	19.99	15.28	70.85	54.15	40 / 580	40 / 580
12	4.34	3.25	61.98	46.41	219.63	164.47	30 / 435	30 / 435
19	11.20	8.20	159.95	117.10	566.80	414.98	30 / 435	30 / 435
32	29.40	23.80	419.86	339.89	1,487.84	1,204.44	30 / 435	30 / 435

One side self-sealing (EA). Both sides self-sealing (BA). The pressure values are applicable at a temperature of 20°C. Please inquire about other temperature ranges.

Stated maximum permissible operating pressures (p max. permissible static) only apply to materials specified by us and to operation with group II media according to directive 2014/68/EU. Material combinations, optional materials, as well as other media or other temperature ranges can lead to divergent maximum permissible operating pressures and must be requested separately.

Please note that the maximum permissible operating pressure of the connection and quick coupling system must be considered when determining the operating pressure. Our safety instructions must be followed.

◀◀ The **performance diagram** can be found on the front catalogue fold-out page.

A detailed **connection description** can be found on the back catalogue fold-out page. ▶▶

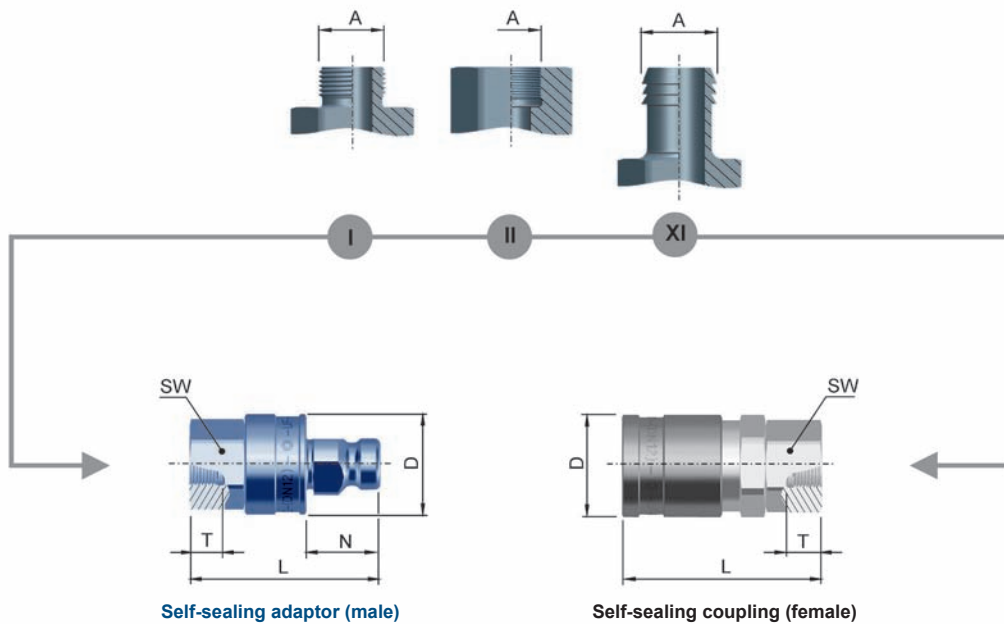





## Features chart | Quick coupling systems

	Product features	Materials	Seals	Additional options
Standard		01 = Stainless steel 1.4404/1.4571 or similar 21 = Brass passivated 22 = Brass chrome plated	1 = NBR 2 = FKM 4 = EPDM	DR = With triangular fitting FD = FDA-compliant FF = Oil- and grease-free GG = With ring grips Ø 190 (aluminium cast) OV = Without valve TA = Certified by the Clean Air Act (TA-Luft) SI = Additional axial safety locking device VI = With square fitting
Optional	- Non-interchangeable versions (mechanical coding)	24 = Brass chemically nickel plated	FFKM to nb 12	More on request (see pages 19-20)

UF-006: SI – Outside diameter 29 mm    UF-012: SI – Outside diameter 44 mm    UF-032: SI – Outside diameter 89 mm  
 UF-007: SI – Outside diameter 34 mm    UF-019: SI – Outside diameter 62 mm

Special closures on request.

**Note:** The additional feature DR or VI is an integral component of the part number and must be specified!

**Attention:** GG and SI cannot be combined = Special version - please enquire

**Attention:** Self-sealing coupling + OV: Product type ≙ Thru-type coupling; Self-sealing adaptor + OV: Product type ≙ Thru-type adaptor

For example, a complete part number looks like this:

**UF-006-0-SL006-Material-Seal-Additional options-Y../-Z..**



## Product chart | Quick coupling systems

Self-sealing adaptor / thru-type adaptor marked in blue

NB	Product type	A	De- sign	Pipe ID	SW	T	D	L	N	Weight Brass	Material-neutral part number
6	Self-sealing coupling (female)	6 mm	XI	4	19	25	25	72		120	UF-006-0-SL006-...
6	Self-sealing coupling (female)	9 mm	XI		19	30	25	77		120	UF-006-0-SL009-...
6	Self-sealing coupling (female)	11 mm	XI		19	30	25	77		130	UF-006-0-SL011-...
6	Self-sealing coupling (female)	13 mm	XI		19	30	25	77		140	UF-006-0-SL013-...

**NB** - Nominal bore [mm]    **A** - Connection    **SW** - Wrench size [mm]    **T** - Thread length [mm]    **D** - Diameter [mm]    **L** - Length [mm]    **N** - Adaptor length [mm]    Weight [g]



## Series UF



### Product chart | Quick coupling systems

Self-sealing adaptor / thru-type adaptor marked in blue

NB	Product type	A	De- sign	Pipe ID	SW	T	D	L	N	Weight Brass	Material-neutral part number
6	Self-sealing coupling (female)	BSPP 1/4"	I		19	11	25	58		120	UF-006-0-WR013-...
6	Self-sealing coupling (female)	BSPP 3/8"	I		19	12	25	59		130	UF-006-0-WR017-...
6	Self-sealing coupling (female)	BSPP 1/2"	I		22	15	25	62		150	UF-006-0-WR021-...
6	Self-sealing coupling (female)	BSPP 1/4"	II		19	13	25	57		120	UF-006-0-WR513-...
6	Self-sealing coupling (female)	BSPP 3/8"	II		22	14	25	58		130	UF-006-0-WR517-...
6	Thru-type adaptor (male)	6 mm	XI	4		25	16	50.5	21.1	22	UF-006-1-SL006-..
6	Thru-type adaptor (male)	9 mm	XI			30	16	54.5	21.1	27	UF-006-1-SL009-..
6	Thru-type adaptor (male)	11 mm	XI			30	16	54.5	21.1	35	UF-006-1-SL011-..
6	Thru-type adaptor (male)	BSPP 1/4"	I		17	11	18.9	38.5	21.1	29	UF-006-1-WR013-..
6	Thru-type adaptor (male)	BSPP 3/8"	I		19	12	21	39.5	21.1	41	UF-006-1-WR017-..
6	Thru-type adaptor (male)	BSPP 1/4"	II		17	14	18.9	39.5	21.1	38	UF-006-1-WR513-..
6	Self-sealing adaptor (male)	6 mm	XI	4	19	25	25	70	20.1	85	UF-006-2-SL006-...
6	Self-sealing adaptor (male)	9 mm	XI		19	30	25	75	20.1	90	UF-006-2-SL009-...
6	Self-sealing adaptor (male)	11 mm	XI		19	30	25	75	20.1	95	UF-006-2-SL011-...
6	Self-sealing adaptor (male)	13 mm	XI		19	30	25	75	20.1	110	UF-006-2-SL013-...
6	Self-sealing adaptor (male)	BSPP 1/4"	I		19	11	25	56	20.1	90	UF-006-2-WR013-...
6	Self-sealing adaptor (male)	BSPP 3/8"	I		19	12	25	57	20.1	100	UF-006-2-WR017-...
6	Self-sealing adaptor (male)	BSPP 1/2"	I		22	15	25	60	20.1	120	UF-006-2-WR021-...
6	Self-sealing adaptor (male)	BSPP 1/4"	II		19	13	25	55	20.1	95	UF-006-2-WR513-...
6	Self-sealing adaptor (male)	BSPP 3/8"	II		22	14	25	56	20.1	100	UF-006-2-WR517-...
7	Self-sealing coupling (female)	9 mm	XI	6	24	30	30	86		210	UF-007-0-SL009-...
7	Self-sealing coupling (female)	11 mm	XI		24	30	30	86		210	UF-007-0-SL011-...

NB - Nominal bore [mm] A - Connection SW - Wrench size [mm] T - Thread length [mm] D - Diameter [mm] L - Length [mm] N - Adaptor length [mm] Weight [g]

**Product chart | Quick coupling systems**

Self-sealing adaptor / thru-type adaptor marked in blue

NB	Product type	A	De- sign	Pipe ID	SW	T	D	L	N	Weight Brass	Material-neutral part number
7	Self-sealing coupling (female)	13 mm	XI		24	30	30	86		220	UF-007-0-SL013-...
7	Self-sealing coupling (female)	BSPP 3/8"	I		24	12	30	68		210	UF-007-0-WR017-...
7	Self-sealing coupling (female)	BSPP 1/2"	I		24	15	30	71		230	UF-007-0-WR021-...
7	Self-sealing coupling (female)	BSPP 3/8"	II		24	14	30	68		230	UF-007-0-WR517-...
7	Self-sealing coupling (female)	BSPP 1/2"	II		27	17	30	71		240	UF-007-0-WR521-...
7	Thru-type adaptor (male)	9 mm	XI	6		30	18	58.5	24.5	35	UF-007-1-SL009-..
7	Thru-type adaptor (male)	11 mm	XI			30	18	58.5	24.5	42	UF-007-1-SL011-..
7	Thru-type adaptor (male)	13 mm	XI			30	18	58.5	24.5	53	UF-007-1-SL013-..
7	Thru-type adaptor (male)	BSPP 3/8"	I		19	12	21	45	24.5	62	UF-007-1-WR017-..
7	Thru-type adaptor (male)	BSPP 3/8"	II		22	14	24	44	24.5	69	UF-007-1-WR517-..
7	Self-sealing adaptor (male)	9 mm	XI	6	24	30	30	85.5	23.5	170	UF-007-2-SL009-...
7	Self-sealing adaptor (male)	11 mm	XI		24	30	30	85.5	23.5	170	UF-007-2-SL011-...
7	Self-sealing adaptor (male)	13 mm	XI		24	30	30	85.5	23.5	180	UF-007-2-SL013-...
7	Self-sealing adaptor (male)	BSPP 3/8"	I		24	12	30	67.5	23.5	170	UF-007-2-WR017-...
7	Self-sealing adaptor (male)	BSPP 1/2"	I		24	15	30	70.5	23.5	190	UF-007-2-WR021-...
7	Self-sealing adaptor (male)	BSPP 3/8"	II		24	14	30	67.5	23.5	180	UF-007-2-WR517-...
7	Self-sealing adaptor (male)	BSPP 1/2"	II		27	17	30	70.5	23.5	200	UF-007-2-WR521-...
12	Self-sealing coupling (female)	16 mm	XI		32	35	40	102		435	UF-012-0-SL016-...
12	Self-sealing coupling (female)	19 mm	XI		32	35	40	102		468	UF-012-0-SL019-...
12	Self-sealing coupling (female)	BSPP 1/2"	I		32	15	40	82		420	UF-012-0-WR021-...
12	Self-sealing coupling (female)	BSPP 3/4"	I		32	17	40	84		466	UF-012-0-WR026-...
12	Self-sealing coupling (female)	BSPP 1"	I		32	20	40	88		546	UF-012-0-WR033-...

NB - Nominal bore [mm] A - Connection SW - Wrench size [mm] T - Thread length [mm] D - Diameter [mm] L - Length [mm] N - Adaptor length [mm] Weight [g]



## Series UF



### Product chart | Quick coupling systems

Self-sealing adaptor / thru-type adaptor marked in blue

NB	Product type	A	De- sign	Pipe ID	SW	T	D	L	N	Weight Brass	Material-neutral part number
12	Self-sealing coupling (female)	BSPP 1/2"	II		32	17	40	81		450	UF-012-0-WR521-...-
12	Self-sealing coupling (female)	BSPP 3/4"	II		32	19	40	83		475	UF-012-0-WR526-...-
12	Thru-type adaptor (male)	16 mm	XI			35	25	70.5	31.5	104	UF-012-1-SL016-..
12	Thru-type adaptor (male)	BSPP 1/2"	I		27	15	30	54.5	31.5	131	UF-012-1-WR021-..
12	Thru-type adaptor (male)	BSPP 1/2"	II		30	17	33.5	54.5	31.5	183	UF-012-1-WR521-..
12	Self-sealing adaptor (male)	16 mm	XI		32	35	40	100	29.5	328	UF-012-2-SL016-...-
12	Self-sealing adaptor (male)	19 mm	XI		32	35	40	100	29.5	361	UF-012-2-SL019-...-
12	Self-sealing adaptor (male)	BSPP 1/2"	I		32	15	40	80	29.5	312	UF-012-2-WR021-...-
12	Self-sealing adaptor (male)	BSPP 3/4"	I		32	17	40	82	29.5	359	UF-012-2-WR026-...-
12	Self-sealing adaptor (male)	BSPP 1"	I		36	20	40	86	29.5	440	UF-012-2-WR033-...-
12	Self-sealing adaptor (male)	BSPP 1/2"	II		32	17	40	79	29.5	344	UF-012-2-WR521-...-
12	Self-sealing adaptor (male)	BSPP 3/4"	II		32	19	40	81	29.5	375	UF-012-2-WR526-...-
19	Self-sealing coupling (female)	19 mm	XI	13	46	35	60	118		1,110	UF-019-0-SL019-...-
19	Self-sealing coupling (female)	25 mm	XI		46	40	60	123		1,170	UF-019-0-SL025-...-
19	Self-sealing coupling (female)	28 mm	XI		46	45	60	128		1,200	UF-019-0-SL028-...-
19	Self-sealing coupling (female)	BSPP 3/4"	I		46	17	60	100		1,080	UF-019-0-WR026-...-
19	Self-sealing coupling (female)	BSPP 1"	I		46	20	60	103		1,110	UF-019-0-WR033-...-
19	Self-sealing coupling (female)	BSPP 3/4"	II		46	19	60	94		1,130	UF-019-0-WR526-...-
19	Self-sealing coupling (female)	BSPP 1"	II		46	23	60	98		1,120	UF-019-0-WR533-...-
19	Thru-type adaptor (male)	25 mm	XI			40	38	83	34.5	289	UF-019-1-SL025-..
19	Thru-type adaptor (male)	BSPP 3/4"	I		41	17	45.5	61.5	34.5	320	UF-019-1-WR026-..
19	Thru-type adaptor (male)	BSPP 1"	II		41	23	45.5	63.5	34.5	365	UF-019-1-WR533-..

NB - Nominal bore [mm] A - Connection SW - Wrench size [mm] T - Thread length [mm] D - Diameter [mm] L - Length [mm] N - Adaptor length [mm] Weight [g]

**Product chart | Quick coupling systems**

Self-sealing adaptor / thru-type adaptor marked in blue

NB	Product type	A	De-sign	Pipe ID	SW	T	D	L	N	Weight Brass	Material-neutral part number
19	Self-sealing adaptor (male)	19 mm"	XI	13	46	35	54	114	32.5	790	UF-019-2-SL019-...
19	Self-sealing adaptor (male)	25 mm"	XI		46	40	54	119	32.5	860	UF-019-2-SL025-...
19	Self-sealing adaptor (male)	28 mm"	XI		46	45	54	124	32.5	890	UF-019-2-SL028-...
19	Self-sealing adaptor (male)	BSPP 3/4"	I		46	17	54	96	32.5	760	UF-019-2-WR026-...
19	Self-sealing adaptor (male)	BSPP 1"	I		46	20	54	99	32.5	790	UF-019-2-WR033-...
19	Self-sealing adaptor (male)	BSPP 3/4"	II		46	19	54	90	32.5	810	UF-019-2-WR526-...
19	Self-sealing adaptor (male)	BSPP 1"	II		46	23	54	94	32.5	800	UF-019-2-WR533-...
32	Self-sealing coupling (female)	42 mm	XI		75	61	82	178		3,460	UF-032-0-SL042-...
32	Self-sealing coupling (female)	53 mm	XI		75	70	82	182		3,840	UF-032-0-SL053-...
32	Self-sealing coupling (female)	BSPP 1 1/2"	I		75	22	82	139		3,290	UF-032-0-WR048-...
32	Self-sealing coupling (female)	BSPP 2"	I		75	26	82	143		3,510	UF-032-0-WR060-...
32	Self-sealing coupling (female)	BSPP 1 1/2"	II		75	25	82	126		3,280	UF-032-0-WR548-...
32	Self-sealing coupling (female)	BSPP 2"	II		75	29	82	130		3,130	UF-032-0-WR560-...
32	Thru-type adaptor (male)	42 mm	XI			61	60	108	39	730	UF-032-1-SL042-..
32	Thru-type adaptor (male)	BSPP 1 1/2 "	I		55	22	61.3	74.5	39	680	UF-032-1-WR048-..
32	Thru-type adaptor (male)	BSPP 1 1/2"	II		60	25	66.5	72	39	720	UF-032-1-WR548-..
32	Self-sealing adaptor (male)	42 mm	XI		75	61	82	174.5	39	2,940	UF-032-2-SL042-...
32	Self-sealing adaptor (male)	53 mm	XI		75	70	82	178.5	39	3,320	UF-032-2-SL053-...
32	Self-sealing adaptor (male)	BSPP 1 1/2"	I		75	22	82	135.5	39	2,750	UF-032-2-WR048-...
32	Self-sealing adaptor (male)	BSPP 2"	I		75	26	82	139.5	39	2,980	UF-032-2-WR060-...
32	Self-sealing adaptor (male)	BSPP 1 1/2"	II		75	25	82	122.5	39	2,740	UF-032-2-WR548-...
32	Self-sealing adaptor (male)	BSPP 2"	II		75	29	82	126.5	39	2,600	UF-032-2-WR560-...

NB - Nominal bore [mm] A - Connection SW - Wrench size [mm] T - Thread length [mm] D - Diameter [mm] L - Length [mm] N - Adaptor length [mm] Weight [g]



## Series UM

### Technical chart | Quick coupling systems

Nominal bore [mm]	Cv value		Q [L/min] water 20 °C, Δp = 1 bar		Q [m³/h] air 6 bar, 20 °C, Δp = 1 bar		p max. permissible static [bar / psi]	
	EA	BA	EA	BA	EA	BA	Brass	Stainless steel
							coupled	coupled
4	0.36		5.14		18.22		20 / 290	
6		0.77		11.00		38.97		20 / 290
12		3.25		46.41		164.47		20 / 290

One side self-sealing (EA). Both sides self-sealing (BA). The pressure values are applicable at a temperature of 20°C. Please inquire about other temperature ranges.

Stated maximum permissible operating pressures (p max. permissible static) only apply to materials specified by us and to operation with group II media according to directive 2014/68/EU. Material combinations, optional materials, as well as other media or other temperature ranges can lead to divergent maximum permissible operating pressures and must be requested separately.

Please note that the maximum permissible operating pressure of the connection and quick coupling system must be considered when determining the operating pressure. Our safety instructions must be followed.

◀◀ The **performance diagram** can be found on the front catalogue fold-out page.

A detailed **connection description** can be found on the back catalogue fold-out page. ▶▶

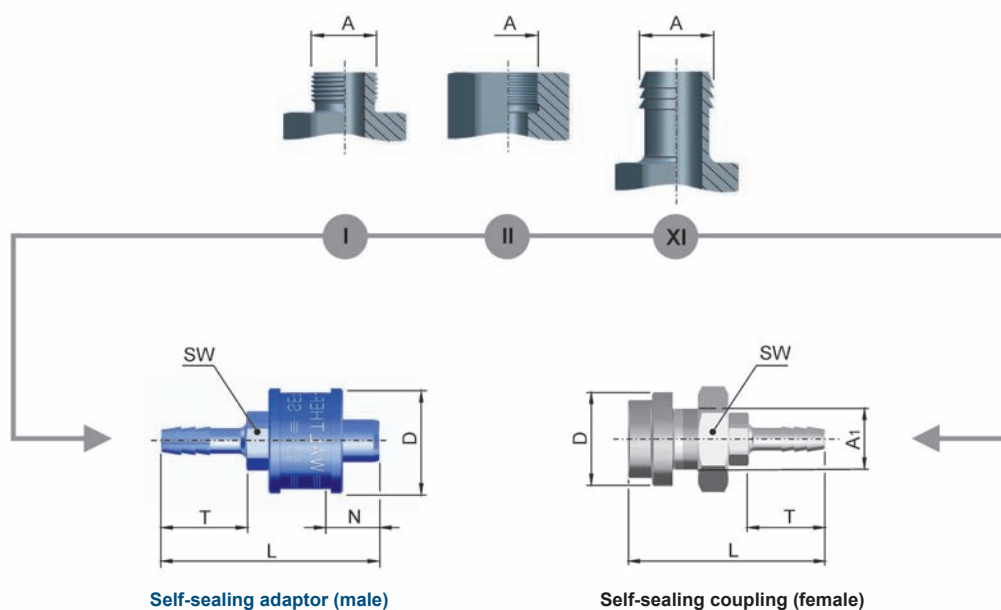





## Series UM

### Features chart | Quick coupling systems

	Product features	Materials	Seals	Additional options
Standard	<ul style="list-style-type: none"> <li>- Automatic locking</li> <li>- Manipulator operable</li> <li>- Non-interchangeable round fitting R1-R5</li> <li>- Character and colour coding according to NB possible</li> </ul>	23 = Brass nickel plated  Closing bush and locking sleeve: Aluminium, colour coding  <b>From UM-006</b> 01 = Stainless steel 1.4404/1.4571 or similar	1 = NBR 2 = FKM 4 = EPDM	OV = Without valve R0-R5 = With round fitting
Optional	<ul style="list-style-type: none"> <li>- Available with general fitting from nominal bore 6 (version -R0)</li> <li>- Coupling end for bulkhead mounting</li> </ul>			

The diameter is to be requested depending on the round fitting.

**Maximum bulkhead thickness:** NB 4 = 5 mm, NB 6 = 10 mm, NB 12 = 18 mm

**Note:** The additional feature R0 or R1-R5 is an integral component of the part number and must be specified!

**Attention:** Self-sealing coupling + OV  $\triangleq$  Product type Thru-type coupling; Self-sealing adaptor + OV  $\triangleq$  Product type Thru-type adaptor

For example, a complete part number looks like this:

**UM-004-0-WR010-Material-Seal-Additional options-Y./-Z..**

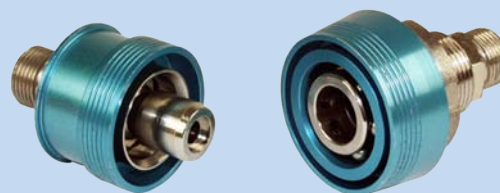

### Product chart | Quick coupling systems

Self-sealing adaptor / thru-type adaptor marked in blue

NB	Product type	A / A1	Design	SW	T	D	L	N	Weight Brass	Material-neutral part number
4	Self-sealing coupling (female)	BSPP 1/8" M 18 x 0.75	I	22	10	36	45.5		115	UM-004-0-WR010-...-
4	Thru-type adaptor (male)	6 mm	XI	14	20	27-31	63.5	15.5	110	UM-004-1-SL006-..

NB - Nominal bore [mm] A / A1 - Connection SW - Wrench size [mm] T - Thread length [mm] D - Diameter [mm] L - Length [mm] N - Adaptor length [mm] Weight [g]



## Series UM

### Product chart | Quick coupling systems

Self-sealing adaptor marked in blue

NB	Product type	A / A1	Range	SW	T	D	L	N	Weight Stainless steel	Material-neutral part number
6	Self-sealing coupling (female)	9 mm M 24 x 1.5	XI	36	30	37-46	77.5		223	UM-006-0-SL009-...
6	Self-sealing coupling (female)	11 mm M 24 x 1.5	XI	36	30	37-46	77.5		231	UM-006-0-SL011-...
6	Self-sealing coupling (female)	13 mm M 24 x 1.5	XI	36	30	37-46	78		239	UM-006-0-SL013-...
6	Self-sealing coupling (female)	BSPP 1/4" M 24 x 1.5	I	36	11	37-46	58.5		222	UM-006-0-WR013-...
6	Self-sealing coupling (female)	BSPP 3/8" M 24 x 1.5	I	36	12	37-46	59.5		230	UM-006-0-WR017-...
6	Self-sealing coupling (female)	BSPP 1/4" M 24 x 1.5	II	36	13	37-46	57.5		231	UM-006-0-WR513-...
6	Self-sealing adaptor (male)	9 mm	XI	19	30	37-38	78.5	22.5	171	UM-006-2-SL009-...
6	Self-sealing adaptor (male)	11 mm	XI	19	30	37-38	78.5	22.5	179	UM-006-2-SL011-...
6	Self-sealing adaptor (male)	13 mm	XI	19	30	37-38	79	22.5	187	UM-006-2-SL013-...
6	Self-sealing adaptor (male)	BSPP 1/4"	I	19	11	37-38	60	22.5	170	UM-006-2-WR013-...
6	Self-sealing adaptor (male)	BSPP 3/8"	I	19	12	37-38	61	22.5	178	UM-006-2-WR017-...
6	Self-sealing adaptor (male)	BSPP 1/4"	II	19	13	37-38	58.5	22.5	179	UM-006-2-WR513-...
12	Self-sealing coupling (female)	16 mm M 38 x 1.5	XI	32	35	55-66	103.5		1,764	UM-012-0-SL016-...
12	Self-sealing coupling (female)	BSPP 1/2" M 38 x 1.5	I	32	15	55-66	83.5		1,752	UM-012-0-WR021-...
12	Self-sealing coupling (female)	BSPP 3/4" M 38 x 1.5	I	32	17	55-66	85.5		1,766	UM-012-0-WR026-...
12	Self-sealing coupling (female)	BSPP 1/2" M 38 x 1.5	II	32	17	55-66	82.5		1,797	UM-012-0-WR521-...
12	Self-sealing coupling (female)	BSPP 3/4" M 38 x 1.5	II	32	19	55-66	84.5		1,766	UM-012-0-WR526-...
12	Self-sealing adaptor (male)	16 mm	XI	32	35	55-56	104	33	896	UM-012-2-SL016-...
12	Self-sealing adaptor (male)	BSPP 1/2"	I	32	15	55-56	84	33	884	UM-012-2-WR021-...
12	Self-sealing adaptor (male)	BSPP 3/4"	I	32	17	55-56	86	33	898	UM-012-2-WR026-...
12	Self-sealing adaptor (male)	BSPP 1/2"	II	32	17	55-56	83	33	926	UM-012-2-WR521-...
12	Self-sealing adaptor (male)	BSPP 3/4"	II	32	19	55-56	85	33	898	UM-012-2-WR526-...

NB - Nominal bore [mm] A / A1 - Connection SW - Wrench size [mm] T - Thread length [mm] D - Diameter [mm] L - Length [mm] N - Adaptor length [mm] Weight [g]





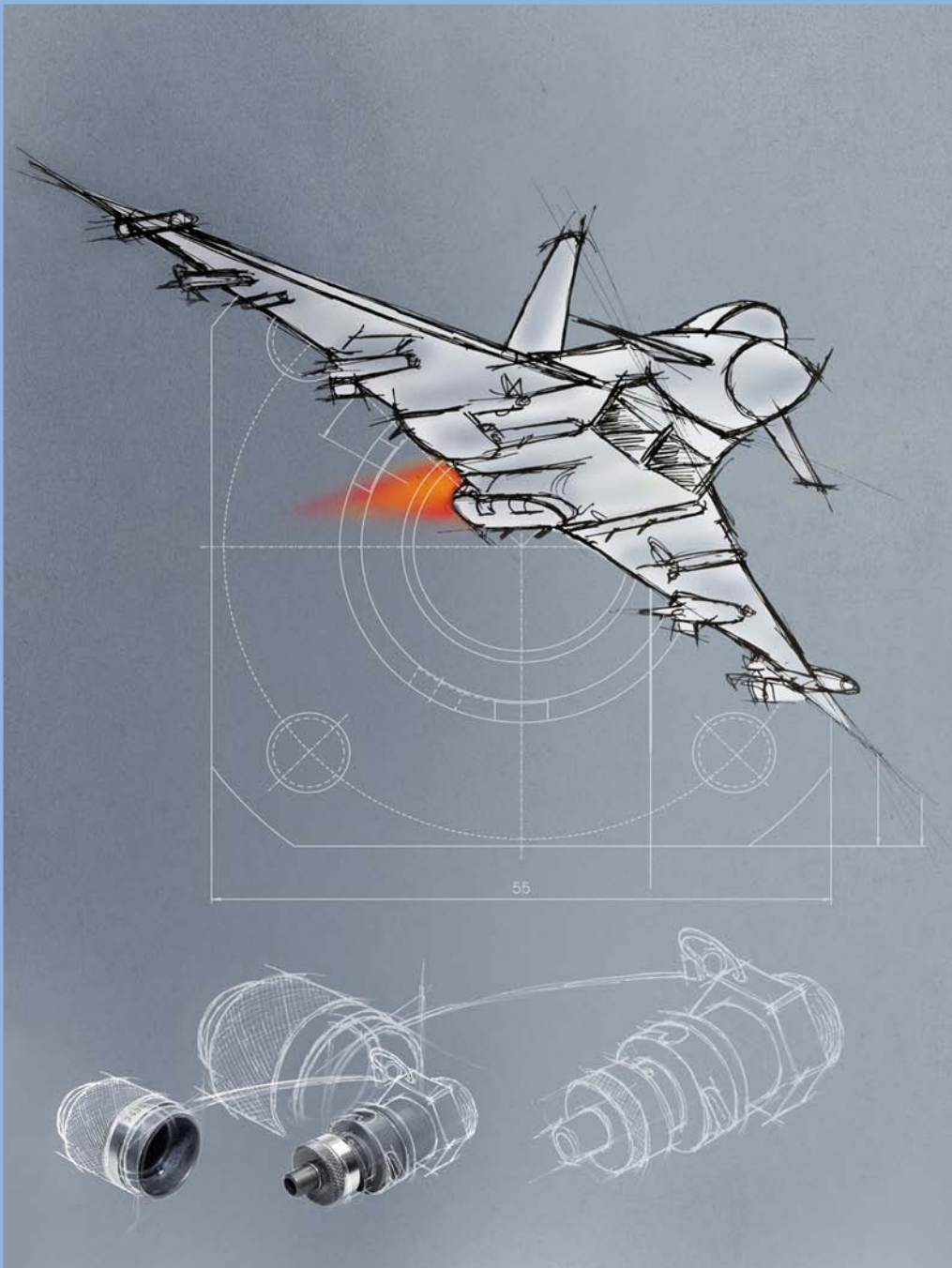

Medium pressure quick coupling systems are frequently used in hydraulic applications and in the supply of gas in higher pressure ranges. While steel designs are usually sufficient in oil hydraulics, stainless steel is used in some gas applications and in the field of water hydraulics. A variety of connection types, sealing materials and valve systems (also leakage minimized clean break) are also installed here. Your use is our success!



## Quick coupling systems up to 250 bar / 3,625 psi

### Series Finder

Clean break valve designs marked in green

Typical applications	Features + options	Maximum permissible static pressure* [bar / psi]	Standard temperature** [°C]	Series	Page
Hydraulics	Squirt- and drip-free, safety lock (-ST) against unintentional disconnection, dirt-proof locking sleeve (-Z12), ATEX model (-EX)	250 / 3,625	-15 to +200	<b>CP</b>	114
Hydraulic training units	Automatic locking	130 / 1,885	-15 to +200	<b>FF / 15</b>	118
Hydraulics, water, steam, gases, mechanical engineering	Nominal bores 6 to 25 are available in stainless steel, as well as in a smooth design without knurling (-GL/-GX).	250 / 3,625	-30 to +200	<b>MD</b>	120
Hydraulic controls training units, general hydraulics	Compact dimensions	250 / 3,625	-15 to +200	<b>SG</b> 	130

\* The max. permissible static pressure depends on the chosen technical version.

\*\* The suitability for temperature depends on the medium, operating pressure and the quick coupling materials used.

We would be happy to provide you with support and advice. Please contact us:



+49 (0) 2129 / 567-405



tk@walther-praezision.de





## Series CP

### Technical chart | Quick coupling systems

Nominal bore [mm]	Cv value		Q [L/min] water 20 °C, Δp = 1 bar		Q [m³/h] air 6 bar, 20 °C, Δp = 1 bar		p max. permissible static [bar / psi]
	EA	BA	EA	BA	EA	BA	
							Stainless steel coupled
6		1.00		14.28		50.61	250 / 3,625
9		3.20		45.70		161.94	250 / 3,625
12		4.50		64.26		227.73	250 / 3,625
16		8.20		117.10		414.98	250 / 3,625

One side self-sealing (EA). Both sides self-sealing (BA). The pressure values are applicable at a temperature of 20°C. Please inquire about other temperature ranges.

Stated maximum permissible operating pressures (p max. permissible static) only apply to materials specified by us and to operation with group II media according to directive 2014/68/EU. Material combinations, optional materials, as well as other media or other temperature ranges can lead to divergent maximum permissible operating pressures and must be requested separately.

Please note that the maximum permissible operating pressure of the connection and quick coupling system must be considered when determining the operating pressure. Our safety instructions must be followed.

◀◀ The **performance diagram** can be found on the front catalogue fold-out page.

A detailed **connection description** can be found on the back catalogue fold-out page. ▶▶

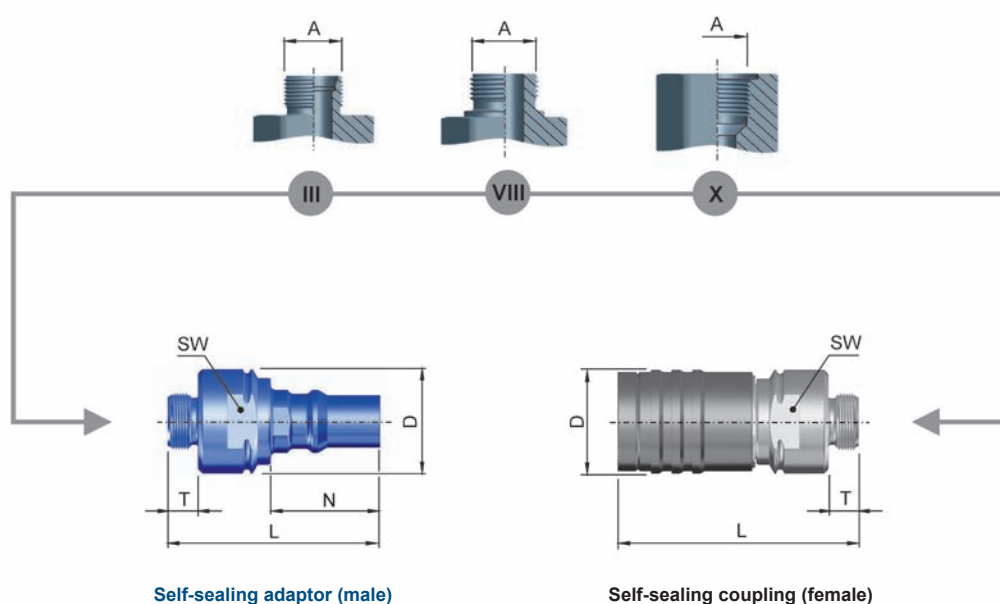





## Series CP

### Features chart | Quick coupling systems

	Product features	Materials	Seals	Additional options
Standard	<ul style="list-style-type: none"> <li>- Low leakage volume during disconnection</li> <li>- Non-squirting</li> <li>- Minimal air intake during connection</li> </ul>	<b>Enclosure</b> Stainless steel 1.4307	2 = FKM	BB = 3.1 production EF = 1935/2004-compliant EX = ATEX-compliant FD = FDA-compliant FF = Oil- and grease-free FL = Free from enamel flow-disturbing substances ST = Safety lock TA = Certified by the Clean Air Act (TA-Luft) Z12 = Dirt-proof locking sleeve
Optional	<ul style="list-style-type: none"> <li>- Automatic locking (one-hand operation)</li> <li>- Connection against residual pressures possible</li> <li>- Disconnection without air release</li> </ul>		FFKM	

**Recommendation:** To protect the sealing faces, the self-sealing adaptors should be firmly mounted and the self-sealing couplings should be used as loose parts. Dust caps for couplings and adaptors are available in PUR plastic (see brochure Dust Caps and Dust Plugs).

For example, a complete part number looks like this:

**CP-006-0-S1018-Material-Seal-Additional options-Y./-Z..**



### Product chart | Quick coupling systems

Self-sealing adaptor marked in blue

NB	Product type	A	De-sign	Ran-ge	Pipe AD	Pipe ID	SW	T	D	L	N	Weight Stainless steel	Material-neutral part number
6	Self-sealing coupling (female)	M 18 x 1.5	III	S	10	4	32	12	35.5	86.5		380	CP-006-0-S1018-...-
6	Self-sealing coupling (female)	BSPP 3/8"	VIII				32	12	35.5	87.5		390	CP-006-0-WB017-...-
6	Self-sealing coupling (female)	BSPP 3/8"	X				32	14	35.5	94		435	CP-006-0-WX517-...-
6	Self-sealing adaptor (male)	M 18 x 1.5	III	S	10	4	32	12	35.5	76	37.6	230	CP-006-2-S1018-...-
6	Self-sealing adaptor (male)	BSPP 3/8"	VIII				32	12	35.5	78.5	37.6	235	CP-006-2-WB017-...-

NB - Nominal bore [mm] A - Connection SW - Wrench size [mm] T - Thread length [mm] D - Diameter [mm] L - Length [mm] N - Adaptor length [mm] Weight [g]



## Series CP

### Product chart | Quick coupling systems

Self-sealing adaptor marked in blue

NB	Product type	A	De- sign	Ran- ge	Pipe AD	Pipe ID	SW	T	D	L	N	Weight Stainless steel	Material-neutral part number
6	Self-sealing adaptor (male)	BSPP 3/8"	X				32	14	35.5	84	37.6	285	CP-006-2-WX517-...
9	Self-sealing coupling (female)	M 22 x 1.5	III	S	14	10	36	14	42	101.5		610	CP-009-0-S1422-...
9	Self-sealing coupling (female)	BSPP 1/2"	VIII				36	14	42	104.5		625	CP-009-0-WB021-...
9	Self-sealing coupling (female)	BSPP 1/2"	X				36	16.5	42	111		705	CP-009-0-WX521-...
9	Self-sealing adaptor (male)	M 22 x 1.5	III	S	14	10	36	14	42	90.5	45	370	CP-009-2-S1422-...
9	Self-sealing adaptor (male)	BSPP 1/2"	VIII				36	14	42	93.5	45	380	CP-009-2-WB021-...
9	Self-sealing adaptor (male)	BSPP 1/2"	X				36	16.5	42	100	45	460	CP-009-2-WX521-...
12	Self-sealing coupling (female)	M 24 x 1.5	III	S	16	12	41	14	48	112		885	CP-012-0-S1624-...
12	Self-sealing coupling (female)	BSPP 1/2"	VIII				41	14	48	115		890	CP-012-0-WB021-...
12	Self-sealing coupling (female)	BSPP 1/2"	X				41	16.5	48	120.5		970	CP-012-0-WX521-...
12	Self-sealing adaptor (male)	M 24 x 1.5	III	S	16	12	41	14	48	98.5	50.5	510	CP-012-2-S1624-...
12	Self-sealing adaptor (male)	BSPP 1/2"	VIII				41	14	48	101.5	50.5	515	CP-012-2-WB021-...
12	Self-sealing adaptor (male)	BSPP 1/2"	X				41	16.5	48	107	50.5	595	CP-012-2-WX521-...
19	Self-sealing coupling (female)	M 30 x 2	III	S	20	16	55	16	63	136		1,980	CP-019-0-S2030-...
19	Self-sealing coupling (female)	BSPP 3/4"	VIII				55	16	63	139		2,000	CP-019-0-WB026-...
19	Self-sealing coupling (female)	BSPP 3/4"	X				55	18.5	63	145		2,220	CP-019-0-WX526-...
19	Self-sealing adaptor (male)	M 30 x 2	III	S	20	16	55	16	63	114.5	57.5	1,010	CP-019-2-S2030-...
19	Self-sealing adaptor (male)	BSPP 3/4"	VIII				55	16	63	117.5	57.5	1,020	CP-019-2-WB026-...

NB - Nominal bore [mm] A - Connection SW - Wrench size [mm] T - Thread length [mm] D - Diameter [mm] L - Length [mm] N - Adaptor length [mm] Weight [g]

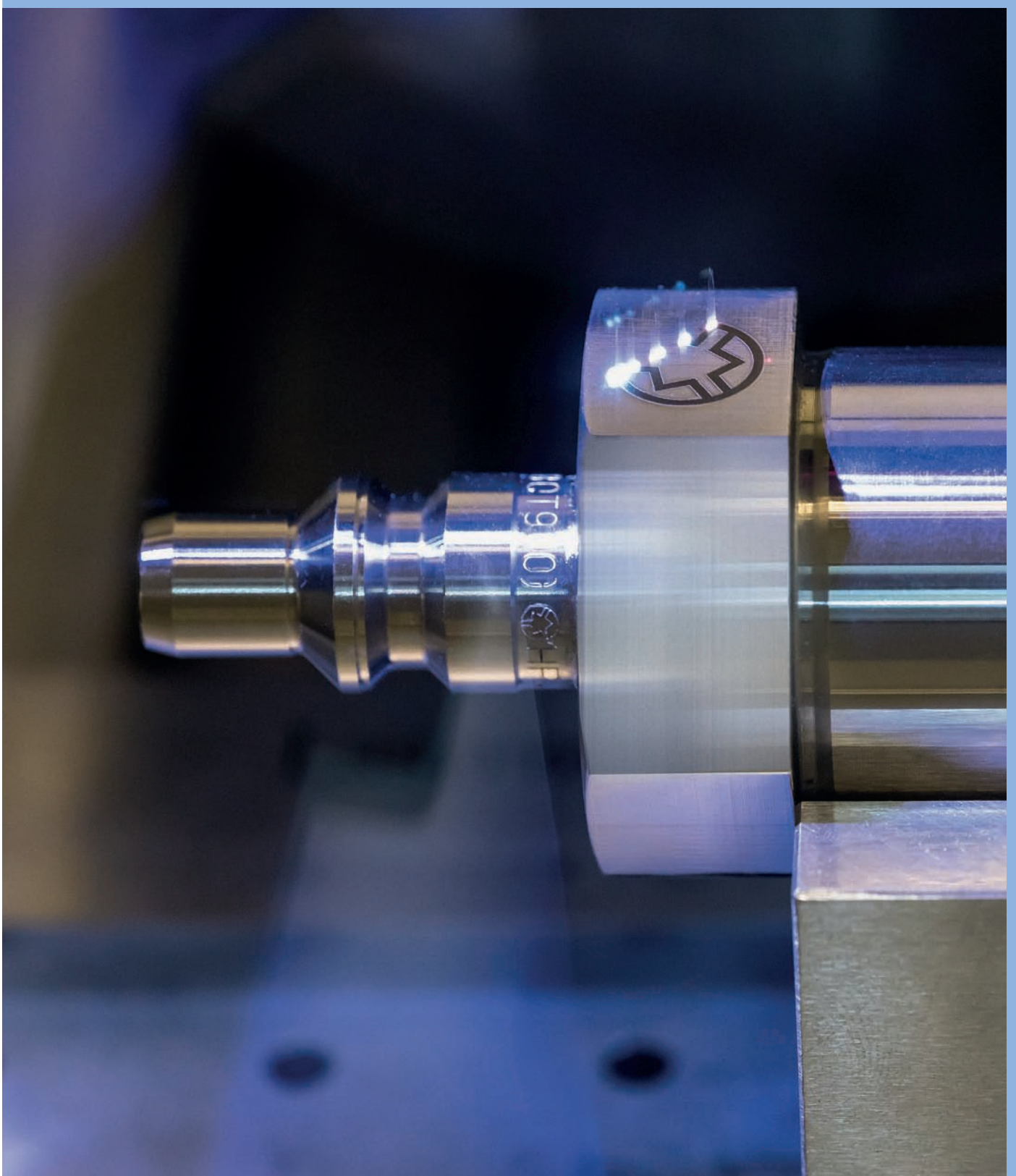



## Series FF / 15

### Technical chart | Quick coupling systems

Nominal bore [mm]	Cv value		Q [L/min] oil (6,1 mm <sup>2</sup> /s; 900 kg/m <sup>3</sup> ) 20 °C, Δp = 1 bar		p max. permissible static [bar / psi]
	EA	BA	EA	BA	
5					WEDISO
					coupled
5		0.72		9.61	130 / 1,885

One side self-sealing (EA). Both sides self-sealing (BA). The pressure values are applicable at a temperature of 20°C. Please inquire about other temperature ranges.

Stated maximum permissible operating pressures (p max. permissible static) only apply to materials specified by us and to operation with group II media according to directive 2014/68/EU. Material combinations, optional materials, as well as other media or other temperature ranges can lead to divergent maximum permissible operating pressures and must be requested separately.

Please note that the maximum permissible operating pressure of the connection and quick coupling system must be considered when determining the operating pressure. Our safety instructions must be followed.

◀◀ The **performance diagram** can be found on the front catalogue fold-out page.

A detailed **connection description** can be found on the back catalogue fold-out page. ▶▶

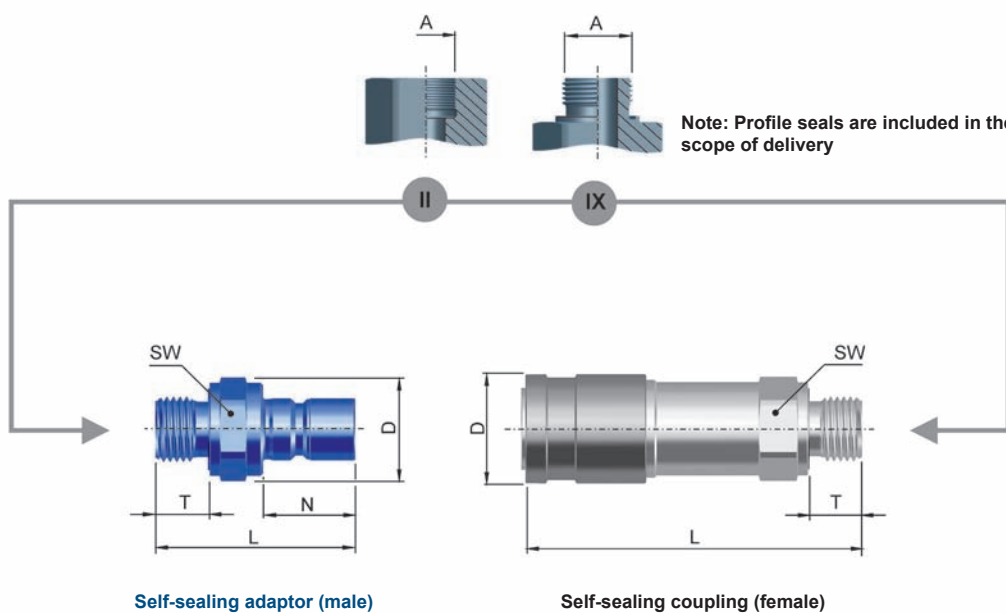



## Series FF / 15

### Features chart | Quick coupling systems

	Product features	WEDISO	Additional options
Standard	<ul style="list-style-type: none"> <li>- Low leakage volume during disconnection</li> <li>- Automatic locking (one-hand operation)</li> <li>- Non-squirting</li> <li>- High flow rate</li> <li>- Disconnection without air release</li> </ul>	<b>Self-sealing coupling</b> <b>15-005-0-XX001</b> AAAA: Galvanised steel, chemically nickel-plated steel, stainless steel 1.4571 and 1.4305 - NBR, AU70 <b>15-005-0-XX010</b> AAAA: Galvanised steel, chemically nickel-plated brass, stainless steel 1.4571 - NBR, AU70  <b>Self-sealing adaptor</b> AAAI: Stainless steel 1.4305, zinc die-casting - NBR	On request (see pages 19-20)
Optional			

**Note:** The additional feature Y01 or Z05 is an integral component of the part number and must be specified!

For example, a complete part number looks like this:

**15-005-0-XX001-WEDISO-Additional options-Y01/-Z05**

### Product chart | Quick coupling systems

Self-sealing adaptor marked in blue

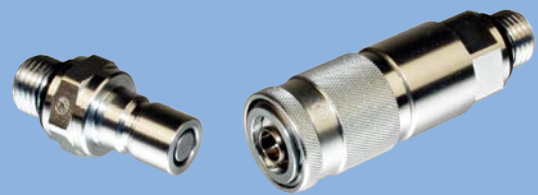

NB	Product type	A	Design	SW	T	D	L	N	Weight Steel	Material-neutral part number
5	Self-sealing coupling (female)	BSPP 1/4"	II	18	8	22.2	62.8		113	15-005-0-XX001-.....Z05
5	Self-sealing coupling (female)	BSPP 1/4"	IX	19	11	22.2	67.3		110	15-005-0-XX010-.....Z05
5	Self-sealing adaptor (male)	BSPP 1/4"	IX	19	11	21.1	40.5	18.7	35	FF-005-2-XX014-.....Y01

**NB** - Nominal bore [mm]   **A** - Connection   **SW** - Wrench size [mm]   **T** - Thread length [mm]   **D** - Diameter [mm]   **L** - Length [mm]   **N** - Adaptor length [mm]   Weight [g]



# Series MD

## Technical chart | Quick coupling systems

Nominal bore [mm]	Cv value		Q [L/min] water 20 °C, Δp = 1 bar		Q [m³/h] air 6 bar, 20 °C, Δp = 1 bar		p max. permissible static [bar / psi]		
	EA	BA	EA	BA	EA	BA	Steel	Brass	Stainless steel
							coupled	coupled	coupled
6		0.73		10.43		36.94	200 / 2,900	40 / 580	100 / 1,450
7		1.07		15.28		54.15	250 / 3,625	40 / 580	100 / 1,450
12		3.25		46.41		164.47	250 / 3,625	40 / 580	100 / 1,450
19		8.20		117.10		414.98	250 / 3,625	40 / 580	50 / 725
25		13.50		192.79		683.19	220 / 3,190	40 / 580	50 / 725
32	29.40	23.80	419.86	339.89	1,487.84	1,204.44	200 / 2,900	40 / 580	40 / 580
50	68.00	59.00	971.11	842.58	3,441.26	2,985.80	100 / 1,450	30 / 435	30 / 435

One side self-sealing (EA). Both sides self-sealing (BA). The pressure values are applicable at a temperature of 20°C. Please inquire about other temperature ranges.

Stated maximum permissible operating pressures (p max. permissible static) only apply to materials specified by us and to operation with group II media according to directive 2014/68/EU. Material combinations, optional materials, as well as other media or other temperature ranges can lead to divergent maximum permissible operating pressures and must be requested separately.

Please note that the maximum permissible operating pressure of the connection and quick coupling system must be considered when determining the operating pressure. Our safety instructions must be followed.

◀◀ The **performance diagram** can be found on the front catalogue fold-out page.

A detailed **connection description** can be found on the back catalogue fold-out page. ▶▶

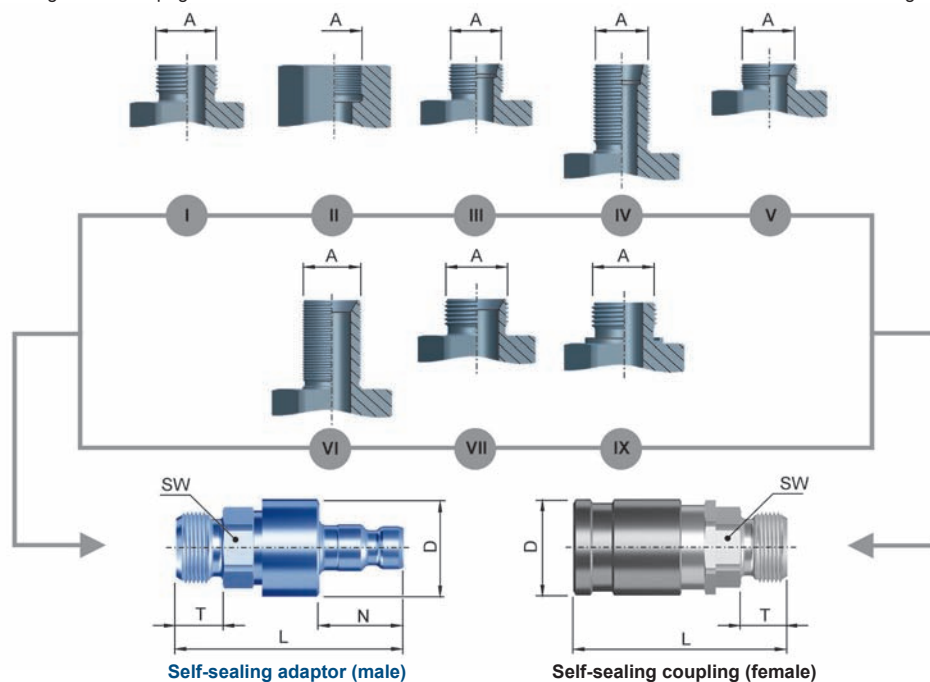





## Features chart | Quick coupling systems

	Product features	Materials	Seals	Additional options
Standard	- Robust medium pressure coupling among others for hydraulics, gases, etc.	01 = Stainless steel 1.4404/1.4571 or similar 19 = Steel zinc plated, partially oil burnished 21 = Brass passivated  <b>Thru-type adaptor</b> 12 = Steel oil burnished	1 = NBR 2 = FKM 4 = EPDM	BB = 3.1 production EF = 1935/2004-compliant EX = ATEX-compliant FD = FDA-compliant FF = Oil- and grease-free FL = Free from enamel flow-disturbing substances GG = With ring grips (aluminium cast): MD-019 = Ø 130 mm, MD-025/032 = Ø 190 mm, MD-050 = Ø 220 mm GL = Smooth design GX = Smooth design with width flat end connection OV = Without valve SI = Additional axial safety locking device TA = Certified by the Clean Air Act (TA-Luft)
Optional		13 = Steel chemically nickel plated 22 = Brass chrome plated 24 = Brass chemically nickel plated  <b>MD-032 / 050</b> 31 = Aluminium silver anodized		

MD-006: SI – Outside diameter 29 mm    MD-012: SI – Outside diameter 44 mm    MD-025: SI – Outside diameter 58 mm  
MD-007: SI – Outside diameter 34 mm    MD-019: SI – Outside diameter 58 mm    MD-032: SI – Outside diameter 89 mm  
MD-050: SI – Outside diameter 116 mm

**Attention:** GG and SI cannot be combined = Special version - please enquire  
**Attention:** Self-sealing coupling + OV ≙ Product type Thru-type coupling; Self-sealing adaptor + OV ≙ Product type Thru-type adaptor

For example, a complete part number looks like this:

**MD-006-0-D0614-Material-Seal-Additional options-Y./-Z..**



## Product chart | Quick coupling systems

Self-sealing adaptor / thru-type adaptor marked in blue

NB	Product type	A	De-sign	Ran-ge	Pipe AD	Pipe ID	SW	T	D	L	N	Weight Steel	Material-neutral part number
6	Self-sealing coupling (female)	M 14 x 1.5	V			6	19	10	25	57		110	MD-006-0-D0614-...-
6	Self-sealing coupling (female)	M 12 x 1.5	III	L	6	4	19	10	25	57		110	MD-006-0-L0612-...-

NB - Nominal bore [mm]    A - Connection    SW - Wrench size [mm]    T - Thread length [mm]    D - Diameter [mm]    L - Length [mm]    N - Adaptor length [mm]    Weight [g]



## Series MD



### Product chart | Quick coupling systems

Self-sealing adaptor / thru-type adaptor marked in blue

NB	Product type	A	De- sign	Ran- ge	Pipe AD	Pipe ID	SW	T	D	L	N	Weight Steel	Material-neutral part number
6	Self-sealing coupling (female)	M 14 x 1.5	III	L	8	6	19	10	25	57		110	MD-006-0-L0814-...
6	Self-sealing coupling (female)	M 16 x 1.5	III	L	10	8	19	11	25	58		110	MD-006-0-L1016-...
6	Self-sealing coupling (female)	M 18 x 1.5	III	L	12	10	19	11	25	58		110	MD-006-0-L1218-...
6	Self-sealing coupling (female)	M 14 x 1.5	IV	L	8	6	19	32	25	79		130	MD-006-0-LV008-...
6	Self-sealing coupling (female)	M 16 x 1.5	III	S	8	4	19	12	25	59		120	MD-006-0-S0816-...
6	Self-sealing coupling (female)	M 18 x 1.5	III	S	10	6	19	12	25	59		120	MD-006-0-S1018-...
6	Self-sealing coupling (female)	M 20 x 1.5	III	S	12	8	22	12	25	59		130	MD-006-0-S1220-...
6	Self-sealing coupling (female)	BSPP 1/4"	VII			6	19	11	25	58		110	MD-006-0-VR013-...
6	Self-sealing coupling (female)	BSPP 3/8"	VII			6	19	12	25	59		120	MD-006-0-VR017-...
6	Self-sealing coupling (female)	BSPP 3/8"	IX				27	12	25	64		157	MD-006-0-WE017-...
6	Self-sealing coupling (female)	BSPP 1/4"	I				19	11	25	58		110	MD-006-0-WR013-...
6	Self-sealing coupling (female)	BSPP 3/8"	I				19	12	25	59		120	MD-006-0-WR017-...
6	Self-sealing coupling (female)	BSPP 1/2"	I				22	15	25	62		140	MD-006-0-WR021-...
6	Self-sealing coupling (female)	BSPP 1/4"	II				19	13	25	57		120	MD-006-0-WR513-...
6	Self-sealing coupling (female)	BSPP 3/8"	II				22	14	25	58		130	MD-006-0-WR517-...
6	Self-sealing coupling (female)	M 16 x 1.5	IV	L	10	8	19	32	25	79		140	MD-006-0-XX211-...
6	Self-sealing adaptor (male)	M 14 x 1.5	V			6	19	10	25	56.5	21.7	85	MD-006-2-D0614-...
6	Self-sealing adaptor (male)	M 12 x 1.5	III	L	6	4	19	10	25	56.5	21.7	85	MD-006-2-L0612-...
6	Self-sealing adaptor (male)	M 14 x 1.5	III	L	8	6	19	10	25	56.5	21.7	85	MD-006-2-L0814-...
6	Self-sealing adaptor (male)	M 16 x 1.5	III	L	10	8	19	11	25	57.5	21.7	85	MD-006-2-L1016-...
6	Self sealing adaptor (male)	M 18 x 1.5	III	L	12	10	19	11	25	57.5	21.7	85	MD-006-2-L1218-...
6	Self sealing adaptor (male)	M 14 x 1.5	IV	L	8	6	19	32	25	78.5	21.7	100	MD-006-2-LV008-...
6	Self-sealing adaptor (male)	M 16 x 1.5	III	S	8	4	19	12	25	58.5	21.7	90	MD-006-2-S0816-...

NB - Nominal bore [mm] A - Connection SW - Wrench size [mm] T - Thread length [mm] D - Diameter [mm] L - Length [mm] N - Adaptor length [mm] Weight [g]

**Product chart | Quick coupling systems**

Self-sealing adaptor / thru-type adaptor marked in blue

NB	Product type	A	De- sign	Ran- ge	Pipe AD	Pipe ID	SW	T	D	L	N	Weight Steel	Material-neutral part number
6	Self-sealing adaptor (male)	M 18 x 1.5	III	S	10	6	19	12	25	58.5	21.7	90	MD-006-2-S1018-...
6	Self-sealing adaptor (male)	M 20 x 1.5	III	S	12	8	22	12	25	58.5	21.7	100	MD-006-2-S1220-...
6	Self-sealing adaptor (male)	BSPP 1/4"	VII			6	19	11	25	57.5	21.7	85	MD-006-2-VR013-...
6	Self-sealing adaptor (male)	BSPP 3/8"	VII			6	19	12	25	58.5	21.7	95	MD-006-2-VR017-...
6	Self-sealing adaptor (male)	BSPP 3/8"	IX				27	12	25	63	21.7	127	MD-006-2-WE017-...
6	Self-sealing adaptor (male)	BSPP 1/4"	I				19	11	25	57.5	21.7	85	MD-006-2-WR013-...
6	Self-sealing adaptor (male)	BSPP 3/8"	I				19	12	25	58.5	21.7	90	MD-006-2-WR017-...
6	Self-sealing adaptor (male)	BSPP 1/2"	I				22	15	25	61.5	21.7	110	MD-006-2-WR021-...
6	Self-sealing adaptor (male)	BSPP 1/4"	II				19	13	25	56.5	21.7	90	MD-006-2-WR513-...
6	Self-sealing adaptor (male)	BSPP 3/8"	II				22	14	25	57.5	21.7	95	MD-006-2-WR517-...
6	Self-sealing adaptor (male)	M 16 x 1.5	IV	L	10	8	19	32	25	78.5	21.7	110	MD-006-2-XX211-...
7	Self-sealing coupling (female)	M 16 x 1.5	V			8	24	11	30	67		200	MD-007-0-D0816-...
7	Self-sealing coupling (female)	M 16 x 1.5	VI			8	24	33.5	30	89.5		220	MD-007-0-DV010-...
7	Self-sealing coupling (female)	M 16 x 1.5	III	L	10	8	24	11	30	67		190	MD-007-0-L1016-...
7	Self-sealing coupling (female)	M 18 x 1.5	III	L	12	10	24	11	30	67		190	MD-007-0-L1218-...
7	Self-sealing coupling (female)	M 18 x 1.5	III	S	10	6	24	11	30	68		200	MD-007-0-S1018-...
7	Self-sealing coupling (female)	M 20 x 1.5	III	S	12	8	24	12	30	68		200	MD-007-0-S1220-...
7	Self-sealing coupling (female)	BSPP 3/8"	VII			7	24	12	30	68		210	MD-007-0-VR017-...
7	Self-sealing coupling (female)	BSPP 3/8"	IX				27	12	30	71		220	MD-007-0-WE017-...
7	Self-sealing coupling (female)	BSPP 3/8"	I				24	12	30	68		200	MD-007-0-WR017-...
7	Self-sealing coupling (female)	BSPP 1/2"	I				24	15	30	71		220	MD-007-0-WR021-...
7	Self-sealing coupling (female)	BSPP 3/8"	II				24	14	30	68		210	MD-007-0-WR517-...

NB - Nominal bore [mm] A - Connection SW - Wrench size [mm] T - Thread length [mm] D - Diameter [mm] L - Length [mm] N - Adaptor length [mm] Weight [g]



## Series MD



### Product chart | Quick coupling systems

Self-sealing adaptor / thru-type adaptor marked in blue

NB	Product type	A	De- sign	Ran- ge	Pipe AD	Pipe ID	SW	T	D	L	N	Weight Steel	Material-neutral part number
7	Self-sealing coupling (female)	BSPP 1/2"	II				27	17	30	71		230	MD-007-0-WR521-...
7	Self-sealing adaptor (male)	M 16 x 1.5	V			8	24	11	30	66.5	25	140	MD-007-2-D0816-...
7	Self-sealing adaptor (male)	M 16 x 1.5	VI			8	24	33.5	30	88	25	170	MD-007-2-DV010-...
7	Self-sealing adaptor (male)	M 16 x 1.5	III	L	10	8	24	11	30	65.5	25	150	MD-007-2-L1016-...
7	Self-sealing adaptor (male)	M 18 x 1.5	III	L	12	10	24	11	30	65.5	25	150	MD-007-2-L1218-...
7	Self-sealing adaptor (male)	M 18 x 1.5	III	S	10	6	24	12	30	66.5	25	160	MD-007-2-S1018-...
7	Self-sealing adaptor (male)	M 20 x 1.5	III	S	12	8	24	12	30	66.5	25	160	MD-007-2-S1220-...
7	Self-sealing adaptor (male)	BSPP 3/8"	VII			7	24	12	30	66.5	25	150	MD-007-2-VR017-...
7	Self-sealing adaptor (male)	BSPP 3/8"	IX				27	12	30	68	25	170	MD-007-2-WE017-...
7	Self-sealing adaptor (male)	BSPP 3/8"	I				24	12	30	66.5	25	150	MD-007-2-WR017-...
7	Self-sealing adaptor (male)	BSPP 1/2"	I				24	15	30	69.5	25	170	MD-007-2-WR021-...
7	Self-sealing adaptor (male)	BSPP 3/8"	II				24	14	30	66.5	25	160	MD-007-2-WR517-...
7	Self-sealing adaptor (male)	BSPP 1/2"	II				27	15	30	69.5	25	180	MD-007-2-WR521-...
12	Self-sealing coupling (female)	M 18 x 1.5	V			10	32	11	40	78		380	MD-012-0-D1018-...
12	Self-sealing coupling (female)	M 22 x 1.5	V			12	32	12	40	79		390	MD-012-0-D1222-...
12	Self-sealing coupling (female)	M 22 x 1.5	VI			13	32	39	40	106		440	MD-012-0-DV015-...
12	Self-sealing coupling (female)	M 18 x 1.5	III	L	12	10	32	11	40	78		380	MD-012-0-L1218-...
12	Self-sealing coupling (female)	M 22 x 1.5	III	L	15	12	32	12	40	79		390	MD-012-0-L1522-...
12	Self-sealing coupling (female)	M 24 x 1.5	III	S	16	12	32	14	40	81		400	MD-012-0-S1624-...
12	Self-sealing coupling (female)	BSPP 1/2"	VII			12	32	15	40	82		390	MD-012-0-VR021-...
12	Self-sealing coupling (female)	BSPP 3/4"	VII			12	32	17	40	84		410	MD-012-0-VR026-...
12	Self-sealing coupling (female)	BSPP 1/2"	IX				32	14	40	84		400	MD-012-0-WE021-...

NB - Nominal bore [mm] A - Connection SW - Wrench size [mm] T - Thread length [mm] D - Diameter [mm] L - Length [mm] N - Adaptor length [mm] Weight [g]

**Product chart | Quick coupling systems**

Self-sealing adaptor / thru-type adaptor marked in blue

NB	Product type	A	De- sign	Ran- ge	Pipe AD	Pipe ID	SW	T	D	L	N	Weight Steel	Material-neutral part number
12	Self-sealing coupling (female)	BSPP 1/2"	I				32	15	40	82		390	MD-012-0-WR021-...
12	Self-sealing coupling (female)	BSPP 3/4"	I				32	17	40	84		420	MD-012-0-WR026-...
12	Self-sealing coupling (female)	BSPP 1"	I				36	20	40	88		480	MD-012-0-WR033-...
12	Self-sealing coupling (female)	BSPP 1/2"	II				32	17	40	81		430	MD-012-0-WR521-...
12	Self-sealing coupling (female)	BSPP 3/4"	II				32	19	40	83		410	MD-012-0-WR526-...
12	Self-sealing adaptor (male)	M 18 x 1.5	V			10	32	11	40	78	31.5	290	MD-012-2-D1018-...
12	Self-sealing adaptor (male)	M 22 x 1.5	V			12	32	12	40	79	31.5	300	MD-012-2-D1222-...
12	Self-sealing adaptor (male)	M 22 x 1.5	IX			13	32	39	40	106	31.5	350	MD-012-2-DV015-...
12	Self-sealing adaptor (male)	M 18 x 1.5	III	L	12	10	32	11	40	78	31.5	290	MD-012-2-L1218-...
12	Self-sealing adaptor (male)	M 22 x 1.5	III	L	15	12	32	12	40	79	31.5	300	MD-012-2-L1522-...
12	Self-sealing adaptor (male)	M 24 x 1.5	III	S	16	12	32	14	40	81	31.5	310	MD-012-2-S1624-...
12	Self-sealing adaptor (male)	BSPP 1/2"	VII			12	32	15	40	82	31.5	300	MD-012-2-VR021-...
12	Self-sealing adaptor (male)	BSPP 3/4"	VI			12	32	17	40	84	31.5	320	MD-012-2-VR026-...
12	Self-sealing adaptor (male)	BSPP 1/2"	IX				32	14	40	84	31.5	310	MD-012-2-WE021-...
12	Self-sealing adaptor (male)	BSPP 1/2"	I				32	15	40	82	31.5	300	MD-012-2-WR021-...
12	Self-sealing adaptor (male)	BSPP 3/4"	I				32	17	40	84	31.5	330	MD-012-2-WR026-...
12	Self-sealing adaptor (male)	BSPP 1"	I				36	20	40	88	31.5	390	MD-012-2-WR033-...
12	Self-sealing adaptor (male)	BSPP 1/2"	II				32	17	40	81	31.5	340	MD-012-2-WR521-...
12	Self-sealing adaptor (male)	BSPP 3/4"	II				32	19	40	83	31.5	320	MD-012-2-WR526-...
19	Self-sealing coupling (female)	M 26 x 1.5	V			15	46	12	54	95		830	MD-019-0-D1526-...
19	Self-sealing coupling (female)	M 30 x 1.5	V			19	46	14	54	97		830	MD-019-0-D1930-...
19	Self-sealing coupling (female)	M 30 x 1.5	VI			19	46	45	54	128		920	MD-019-0-DV022-...

NB - Nominal bore [mm] A - Connection SW - Wrench size [mm] T - Thread length [mm] D - Diameter [mm] L - Length [mm] N - Adaptor length [mm] Weight [g]



## Series MD



### Product chart | Quick coupling systems

Self-sealing adaptor / thru-type adaptor marked in blue

NB	Product type	A	De- sign	Ran- ge	Pipe AD	Pipe ID	SW	T	D	L	N	Weight Steel	Material-neutral part number
19	Self-sealing coupling (female)	M 26 x 1.5	III	L	18	16	46	12	54	95		830	MD-019-0-L1826-...-
19	Self-sealing coupling (female)	M 30 x 2	III	L	22	20	46	14	54	97		830	MD-019-0-L2230-...-
19	Self-sealing coupling (female)	M 30 x 2	III	S	20	16	46	16	54	99		850	MD-019-0-S2030-...-
19	Self-sealing coupling (female)	M 36 x 2	III	S	25	20	46	18	54	101		870	MD-019-0-S2536-...-
19	Self-sealing coupling (female)	BSPP 3/4"	VII			19	46	17	54	100		850	MD-019-0-VR026-...-
19	Self-sealing coupling (female)	BSPP 1"	VII			19	46	20	54	103		880	MD-019-0-VR033-...-
19	Self-sealing coupling (female)	BSPP 3/4"	IX				46	16	54	102		850	MD-019-0-WE026-...-
19	Self-sealing coupling (female)	BSPP 3/4"	I				46	17	54	100		840	MD-019-0-WR026-...-
19	Self-sealing coupling (female)	BSPP 1"	I				46	20	54	103		870	MD-019-0-WR033-...-
19	Self-sealing coupling (female)	BSPP 3/4"	II				46	19	54	94		900	MD-019-0-WR526-...-
19	Self-sealing coupling (female)	BSPP 1"	II				46	23	54	98		880	MD-019-0-WR533-...-
19	Self-sealing adaptor (male)	M 26 x 1.5	V			15	46	12	54	94	35.5	700	MD-019-2-D1526-...-
19	Self-sealing adaptor (male)	M 30 x 1.5	V			19	46	14	54	96	35.5	700	MD-019-2-D1930-...-
19	Self-sealing adaptor (male)	M 30 x 1.5	VI			19	46	45	54	127	35.5	790	MD-019-2-DV022-...-
19	Self-sealing adaptor (male)	M 26 x 1.5	III	L	18	16	46	12	54	94	35.5	700	MD-019-2-L1826-...-
19	Self-sealing adaptor (male)	M 30 x 2	III	L	22	20	46	14	54	96	35.5	700	MD-019-2-L2230-...-
19	Self-sealing adaptor (male)	M 30 x 2	III	S	20	16	46	16	54	98	35.5	720	MD-019-2-S2030-...-
19	Self-sealing adaptor (male)	M 36 x 2	III	S	25	20	46	18	54	100	35.5	740	MD-019-2-S2536-...-
19	Self-sealing adaptor (male)	BSPP 3/4"	VII			19	46	17	54	99	35.5	710	MD-019-2-VR026-...-
19	Self-sealing adaptor (male)	BSPP 1"	VII			19	46	20	54	102	35.5	740	MD-019-2-VR033-...-
19	Self-sealing adaptor (male)	BSPP 3/4"	IX				46	16	54	101	35.5	720	MD-019-2-WE026-...-
19	Self-sealing adaptor (male)	BSPP 3/4"	I				46	17	54	99	35.5	710	MD-019-2-WR026-...-
19	Self-sealing adaptor (male)	BSPP 1"	I				46	20	54	102	35.5	740	MD-019-2-WR033-...-

NB - Nominal bore [mm] A - Connection SW - Wrench size [mm] T - Thread length [mm] D - Diameter [mm] L - Length [mm] N - Adaptor length [mm] Weight [g]



**Product chart | Quick coupling systems**

Self-sealing adaptor / thru-type adaptor marked in blue

NB	Product type	A	De-sign	Ran-ge	Pipe AD	Pipe ID	SW	T	D	L	N	Weight Steel	Material-neutral part number
19	Self-sealing adaptor (male)	BSPP 3/4"	II				46	19	54	93	35.5	770	MD-019-2-WR526-...
19	Self-sealing adaptor (male)	BSPP 1"	II				46	23	54	97	35.5	750	MD-019-2-WR533-...
25	Self-sealing coupling (female)	M 38 x 1.5	V			25	55	14	62	124		1,650	MD-025-0-D2538-...
25	Self-sealing coupling (female)	M 42 x 2	III	S	30	25	55	20	62	130		1,610	MD-025-0-S3042-...
25	Self-sealing coupling (female)	BSPP 1 1/2"	I				55	22	62	132		1,710	MD-025-0-WR048-...
25	Self-sealing coupling (female)	BSPP 1 1/2"	II				55	25	62	138.5		1,740	MD-025-0-WR548-...
25	Self-sealing adaptor (male)	M 38 x 1.5	V				55	14	62	125	45	1,310	MD-025-2-D2538-...
25	Self-sealing adaptor (male)	M 42 x 2	III	S	30	25	55	20	62	131	45	1,280	MD-025-2-S3042-...
25	Self-sealing adaptor (male)	BSPP 1 1/2"	I				55	22	62	133	45	1,370	MD-025-2-WR048-...
25	Self-sealing adaptor (male)	BSPP 1 1/2"	II				55	25	62	139.5	45	1,400	MD-025-2-WR548-...
32	Self-sealing coupling (female)	M 45 x 1.5	V			32	75	16	82	128		2,880	MD-032-0-D3245-...
32	Self-sealing coupling (female)	M 52 x 2	III	S	38	32	75	22	82	134		2,940	MD-032-0-S3852-...
32	Self-sealing coupling (female)	BSPP 1 1/2"	I				75	22	82	139		3,080	MD-032-0-WR048-...
32	Self-sealing coupling (female)	BSPP 2"	I				75	26	82	143		3,290	MD-032-0-WR060-...
32	Self-sealing coupling (female)	BSPP 1 1/2"	II				75	25	82	126		3,050	MD-032-0-WR548-...
32	Self-sealing coupling (female)	BSPP 2"	II				75	29	82	130		2,920	MD-032-0-WR560-...
32	Thru-type adaptor (male)	M 45 x 1.5	V			32	55	16	61.3	70.5	41	510	MD-032-1-D3245-...
32	Thru-type adaptor (male)	M 52 x 2	III	S	38	32	60	22	66.9	82	41	630	MD-032-1-S3852-...
32	Thru-type adaptor (male)	BSPP 1 1/2"	I				55	22	60	82	41	620	MD-032-1-WR048-...
32	Thru-type adaptor (male)	BSPP 2"	I				65	26	72.5	88	41	670	MD-032-1-WR060-...

NB - Nominal bore [mm] A - Connection SW - Wrench size [mm] T - Thread length [mm] D - Diameter [mm] L - Length [mm] N - Adaptor length [mm] Weight [g]



## Series MD



### Product chart | Quick coupling systems

Self-sealing adaptor / thru-type adaptor marked in blue

NB	Product type	A	De- sign	Ran- ge	Pipe AD	Pipe ID	SW	T	D	L	N	Weight Steel	Material-neutral part number
32	Thru-type adaptor (male)	BSPP 1 1/2"	II				60	25	66	75	41	700	MD-032-1-WR548-...
32	Thru-type adaptor (male)	BSPP 2"	II				70	27	78	77	41	820	MD-032-1-WR560-...
32	Self-sealing adaptor (male)	M 45 x 1.5	V			32	75	16	82	126.5	41	2,400	MD-032-2-D3245-...
32	Self-sealing adaptor (male)	M 52 x 2	III	S	38	32	75	22	82	132.5	41	2,460	MD-032-2-S3852-...
32	Self-sealing adaptor (male)	BSPP 1 1/2"	I				75	22	82	137.5	41	2,600	MD-032-2-WR048-...
32	Self-sealing adaptor (male)	BSPP 2"	I				75	26	82	141.5	41	2,810	MD-032-2-WR060-...
32	Self-sealing adaptor (male)	BSPP 1 1/2"	II				75	25	82	124.5	41	2,570	MD-032-2-WR548-...
32	Self-sealing adaptor (male)	BSPP 2"	II				75	29	82	128.5	41	2,440	MD-032-2-WR560-...
32	Thru-type coupling (female)	M 45 x 1.5"	V			32	70	16	82	103		2,140	MD-032-4-D3245-...
32	Thru-type coupling (female)	M 52 x 2"	III	S	38	32	70	22	82	109		2,200	MD-032-4-S3852-...
32	Thru-type coupling (female)	BSPP 1 1/2"	I				70	23	82	110		2,190	MD-032-4-WR048-...
32	Thru-type coupling (female)	BSPP 2"	I				70	26	82	113		2,390	MD-032-4-WR060-...
32	Thru-type coupling (female)	BSPP 1 1/2"	II				70	25	82	87		1,890	MD-032-4-WR548-...
32	Thru-type coupling (female)	BSPP 2"	II				70	27	82	87		1,700	MD-032-4-WR560-...
50	Self-sealing coupling (female)	M 65 x 2	V			49	100	18	112	159		5,460	MD-050-0-D4965-...
50	Self-sealing coupling (female)	M 52 x 2	III	L	42	36	100	16	112	158		5,410	MD-050-0-L4252-...
50	Self-sealing coupling (female)	BSPP 2"	I				100	26	112	162		5,530	MD-050-0-WR060-...
50	Self-sealing coupling (female)	BSPP 2 1/2"	I				100	30	112	164		5,540	MD-050-0-WR075-...
50	Self-sealing coupling (female)	BSPP 2"	II				100	29	112	158		6,140	MD-050-0-WR560-...
50	Self-sealing coupling (female)	BSPP 2 1/2"	II				100	33	112	167		5,930	MD-050-0-WR575-...
50	Thru-type adaptor (male)	M 65 x 2	V			49	85	18	92	93	50	1,550	MD-050-1-D4965-...

NB - Nominal bore [mm] A - Connection SW - Wrench size [mm] T - Thread length [mm] D - Diameter [mm] L - Length [mm] N - Adaptor length [mm] Weight [g]

**Product chart | Quick coupling systems**

Self-sealing adaptor / thru-type adaptor marked in blue

NB	Product type	A	De-sign	Ran-ge	Pipe AD	Pipe ID	SW	T	D	L	N	Weight Steel	Material-neutral part number
50	Thru-type adaptor (male)	M 52 x 2	III	L	42	36	85	16	92	91	50	1,510	MD-050-1-L4252-..
50	Thru-type adaptor (male)	BSPP 2"	I				85	26	92	92	50	1,660	MD-050-1-WR060-..
50	Thru-type adaptor (male)	BSPP 2 1/2"	I				85	30	92	96	50	1,720	MD-050-1-WR075-..
50	Thru-type adaptor (male)	BSPP 2"	II				85	29	92	86	50	1,930	MD-050-1-WR560-..
50	Thru-type adaptor (male)	BSPP 2 1/2"	II				85	33	92	89	50	1,580	MD-050-1-WR575-..
50	Self-sealing adaptor (male)	M 65 x 2	V			49	100	18	112	159	50	4,940	MD-050-2-D4965-...-
50	Self-sealing adaptor (male)	M 52 x 2	III	L	42	36	100	16	112	158	50	4,890	MD-050-2-L4252-...-
50	Self-sealing adaptor (male)	BSPP 2"	I				100	26	112	162	50	5,010	MD-050-2-WR060-...-
50	Self-sealing adaptor (male)	BSPP 2 1/2"	I				100	30	112	164	50	5,020	MD-050-2-WR075-...-
50	Self-sealing adaptor (male)	BSPP 2"	II				100	29	112	158	50	5,620	MD-050-2-WR560-...-
50	Self-sealing adaptor (male)	BSPP 2 1/2"	II				100	33	112	167	50	5,410	MD-050-2-WR575-...-
50	Thru-type coupling (female)	M 65 x 2	V			49	100	18	112	125.5		3,980	MD-050-4-D4965-...-
50	Thru-type coupling (female)	M 52 x 2	III	L	42	36	100	16	112	122		3,920	MD-050-4-L4252-...-
50	Thru-type coupling (female)	BSPP 2"	I				100	26	112	132.5		4,090	MD-050-4-WR060-...-
50	Thru-type coupling (female)	BSPP 2 1/2"	I				100	30	112	137.5		4,340	MD-050-4-WR075-...-
50	Thru-type coupling (female)	BSPP 2 1/2"	II				100	33	112	112		4,100	MD-050-4-WR575-...-

NB - Nominal bore [mm] A - Connection SW - Wrench size [mm] T - Thread length [mm] D - Diameter [mm] L - Length [mm] N - Adaptor length [mm] Weight [g]



## Series SG

### Technical chart | Quick coupling systems

Nominal bore [mm]	Cv value		Q [L/min] water 20 °C, Δp = 1 bar		Q [m³/h] air 6 bar, 20 °C, Δp = 1 bar		p max. permissible static [bar / psi]
	EA	BA	EA	BA	EA	BA	
	6	1,00	0,73	14,28	10,43	50,61	36,94

One side self-sealing (EA). Both sides self-sealing (BA). The pressure values are applicable at a temperature of 20°C. Please inquire about other temperature ranges.

Stated maximum permissible operating pressures (p max. permissible static) only apply to materials specified by us and to operation with group II media according to directive 2014/68/EU. Material combinations, optional materials, as well as other media or other temperature ranges can lead to divergent maximum permissible operating pressures and must be requested separately.

Please note that the maximum permissible operating pressure of the connection and quick coupling system must be considered when determining the operating pressure. Our safety instructions must be followed.

◀◀ The **performance diagram** can be found on the front catalogue fold-out page.

A detailed **connection description** can be found on the back catalogue fold-out page. ▶▶

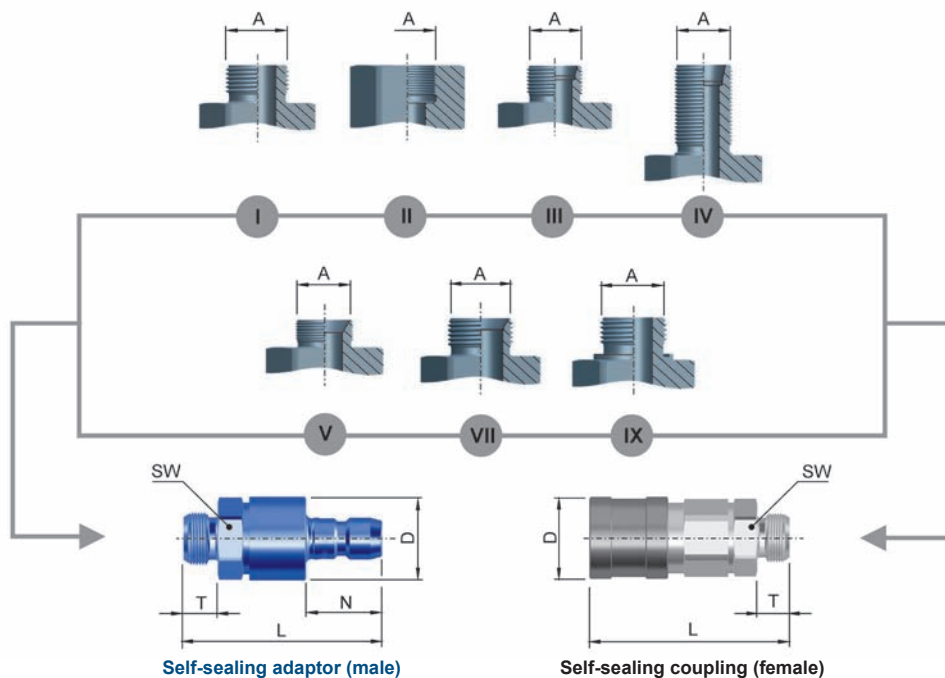



## Series SG

### Features chart | Quick coupling systems

	Product features	Materials	Seals	Additional options
Standard	- Slender design (only Ø 22 mm)	12 = Steel oil burnished 19 = Steel zinc plated, partially oil burnished	1 = NBR 2 = FKM 4 = EPDM	OV = Without valve
Optional		13 = Steel chemically nickel plated		

12 = Burnished steel only applies to Thru-type adaptor

**Attention:** Self-sealing coupling + OV  $\triangleq$  Product type Thru-type coupling; Self-sealing adaptor + OV  $\triangleq$  Product type Thru-type adaptor

For example, a complete part number looks like this:

**SG-006-0-D0614-Material-Seal-Additional options-Y./-Z..**

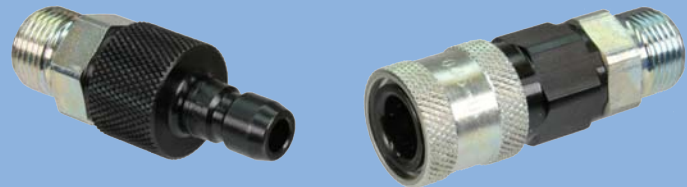

### Product chart | Quick coupling systems

Self-sealing adaptor / thru-type adaptor marked in blue

NB	Product type	A	De- sign	Ran- ge	Pipe AD	Pipe ID	SW	T	D	L	N	Weight Steel	Material-neutral part number
6	Self-sealing coupling (female)	M 14 x 1.5	V			6	19	10	22	57		90	SG-006-0-D0614-...-
6	Self-sealing coupling (female)	M 12 x 1.5	III	L	6	4	19	10	22	57		85	SG-006-0-L0612-...-
6	Self-sealing coupling (female)	M14 x 1.5	III	L	8	6	19	10	22	57		85	SG-006-0-L0814-...-
6	Self-sealing coupling (female)	M 16 x 1.5	III	L	10	8	19	11	22	58		90	SG-006-0-L1016-...-
6	Self-sealing coupling (female)	M 18 x 1.5	III	L	12	10	19	11	22	58		90	SG-006-0-L1218-...-
6	Self-sealing coupling (female)	M 14 x 1.5	IV	L	8	6	19	32	22	79		110	SG-006-0-LV008-...-
6	Self-sealing coupling (female)	M 16 x 1.5	III	S	8	4	19	12	22	59		90	SG-006-0-S0816-...-

NB - Nominal bore [mm] A - Connection SW - Wrench size [mm] T - Thread length [mm] D - Diameter [mm] L - Length [mm] N - Adaptor length [mm] Weight [g]



## Series SG

### Product chart | Quick coupling systems

Self-sealing adaptor / thru-type adaptor marked in blue

NB	Product type	A	De- sign	Ran- ge	Pipe AD	Pipe ID	SW	T	D	L	N	Weight Steel	Material-neutral part number
6	Self-sealing coupling (female)	M 18 x 1.5	III	S	10	6	19	12	22	59		95	SG-006-0-S1018-...-
6	Self-sealing coupling (female)	M 20 x 1.5	III	S	12	8	22	12	22	59		100	SG-006-0-S1220-...-
6	Self-sealing coupling (female)	BSPP 1/4"	VII			6	19	11	22	58		90	SG-006-0-VR013-...-
6	Self-sealing coupling (female)	BSPP 3/8"	VII			6	19	12	22	59		95	SG-006-0-VR017-...-
6	Self-sealing coupling (female)	BSPP 3/8"	IX				27	12	22	64		130	SG-006-0-WE017-...-
6	Self-sealing coupling (female)	BSPP 1/4"	I				19	11	22	58		90	SG-006-0-WR013-...-
6	Self-sealing coupling (female)	BSPP 3/8"	I				19	12	22	59		95	SG-006-0-WR017-...-
6	Self-sealing coupling (female)	BSPP 1/2"	I				22	15	22	62		120	SG-006-0-WR021-...-
6	Self-sealing coupling (female)	BSPP 1/4"	II				19	13	22	57		95	SG-006-0-WR513-...-
6	Self-sealing coupling (female)	BSPP 3/8"	II				22	14	22	58		100	SG-006-0-WR517-...-
6	Self-sealing coupling (female)	M 16 x 1.5	IV	L	10	8	19	32	22	79		120	SG-006-0-XX211-...-
6	Thru-type adaptor (male)	BSPP 1/8 "	I			4	14	8	15.5	34	20	23	SG-006-1-WR010-..
6	Thru-type adaptor (male)	BSPP 1/4 "	I				14	11	19.6	37	20	26	SG-006-1-WR013-..
6	Thru-type adaptor (male)	BSPP 3/8 "	I				19	12	21.9	38	20	37	SG-006-1-WR017-..
6	Thru-type adaptor (male)	BSPP 1/4"	II				17	13	19.6	36	20	26	SG-006-1-WR513-..
6	Thru-type adaptor (male)	BSPP 3/8"	II				22	14	24	37	20	40	SG-006-1-WR517-..
6	Self-sealing adaptor (male)	M 14 x 1.5	V			6	19	10	22	55	20	70	SG-006-2-D0614-...-
6	Self-sealing adaptor (male)	M 12 x 1.5	III	L	6	4	19	10	22	55	20	70	SG-006-2-L0612-...-
6	Self-sealing adaptor (male)	M 14 x 1.5	III	L	8	6	19	10	22	55	20	70	SG-006-2-L0814-...-
6	Self-sealing adaptor (male)	M 16 x 1.6	III	L	10	8	19	11	22	56	20	75	SG-006-2-L1016-...-
6	Self-sealing adaptor (male)	M 18 x 1.5	III	L	12	10	19	11	22	56	20	75	SG-006-2-L1218-...-
6	Self-sealing adaptor (male)	M 14 x 1.5	IV	L	8	6	19	32	22	77	20	90	SG-006-2-LV008-...-

NB - Nominal bore [mm] A - Connection SW - Wrench size [mm] T - Thread length [mm] D - Diameter [mm] L - Length [mm] N - Adaptor length [mm] Weight [g]





## Series SG

### Product chart | Quick coupling systems

Self-sealing adaptor / thru-type adaptor marked in blue

NB	Product type	A	De- sign	Ran- ge	Pipe AD	Pipe ID	SW	T	D	L	N	Weight Steel	Material-neutral part number
6	Self-sealing adaptor (male)	M 16 x 1.5	III	S	8	4	19	12	22	57	20	75	SG-006-2-S0816-...
6	Self-sealing adaptor (male)	M 18 x 1.5	III	S	10	6	19	12	22	57	20	80	SG-006-2-S1018-...
6	Self-sealing adaptor (male)	M 20 x 1.5	III	S	12	8	22	12	22	57	20	85	SG-006-2-S1220-...
6	Self-sealing adaptor (male)	BSPP 1/4"	VII			6	19	11	22	56	20	70	SG-006-2-VR013-...
6	Self-sealing adaptor (male)	BSPP 3/8"	VII			6	19	12	22	57	20	75	SG-006-2-VR017-...
6	Self-sealing adaptor (male)	BSPP 3/8"	IX				27	12	22	62	20	110	SG-006-2-WE017-...
6	Self-sealing adaptor (male)	BSPP 1/4"	I				19	11	22	56	20	70	SG-006-2-WR013-...
6	Self-sealing adaptor (male)	BSPP 3/8"	I				19	12	22	57	20	75	SG-006-2-WR017-...
6	Self-sealing adaptor (male)	BSPP 1/2"	I				22	15	22	60	20	100	SG-006-2-WR021-...
6	Self-sealing adaptor (male)	BSPP 1/4"	II				19	13	22	55	20	75	SG-006-2-WR513-...
6	Self-sealing adaptor (male)	BSPP 3/8"	II				22	14	22	56	20	80	SG-006-2-WR517-...
6	Self-sealing adaptor (male)	M 16 x 1.5	IV	L	10	8	19	32	22	77	20	100	SG-006-2-XX211-...

NB - Nominal bore [mm] A - Connection SW - Wrench size [mm] T - Thread length [mm] D - Diameter [mm] L - Length [mm] N - Adaptor length [mm] Weight [g]

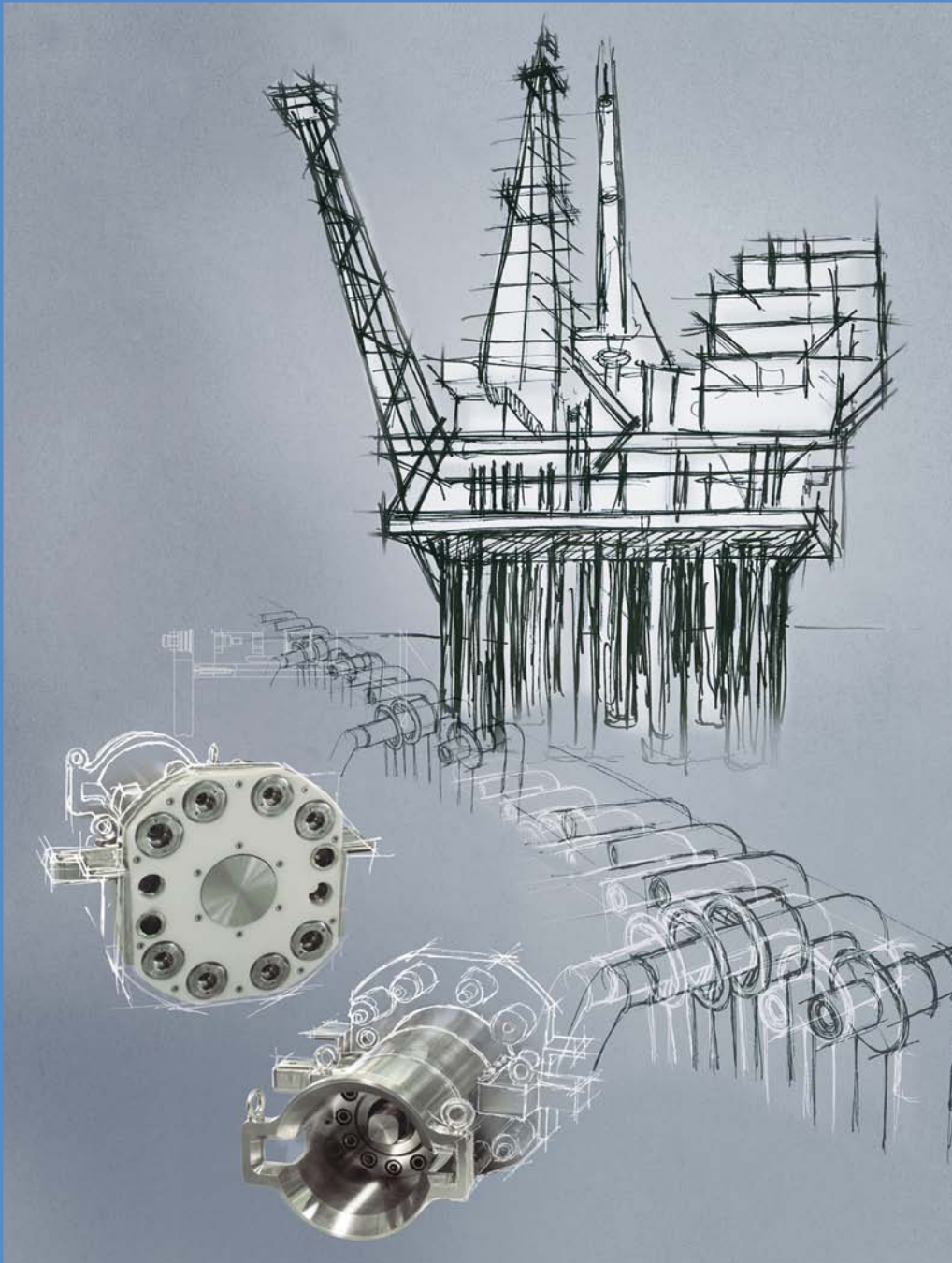

The highest pressures require the highest quality, since the potential for danger in applications in the field of high pressure hydraulics or high pressure gas applications is enormous due to the corresponding energy density. Sturdy, thousandfold-proven valve technology with a robust design distinguishes our high-pressure fittings that often reach exceptionally long service lives even under the harshest of environments. Ring valves and low-leakage clean break valves are used alongside pointed valves.



## Quick coupling systems up to 2,000 bar / 29,000 psi

### Series Finder

Clean break valve designs marked in green

Typical applications	Features + options	Maximum permissible static pressure* [bar / psi]	Standard temperature** [°C]	Series	Page
High-pressure hydraulic mechanical and plant engineering	Flat face, pressure relief valve (-Z11) from nominal bore 12; locking sleeve with dirt protection (-Z12)	650 / 9,430	-15 to +130	HC	136
High-pressure hydraulic mechanical and plant engineering, offshore	Ring valve recommended for high pulsating pressures, seawater-resistant stainless steels, non-interchangeable version, axial safety locking device	2,000 / 29,000	-30 to +200	HP 	140

\* The max. permissible static pressure depends on the chosen technical version.

\*\* The suitability for temperature depends on the medium, operating pressure and the quick coupling materials used.

We would be happy to provide you with support and advice. Please contact us:



+49 (0) 2129 / 567-405



tk@walther-praezision.de





## Series HC

### Technical chart | Quick coupling systems

Nominal bore [mm]	Cv value		Q [L/min] water 20 °C, Δp = 1 bar		Q [m³/h] air 6 bar, 20 °C, Δp = 1 bar		p max. permissible static [bar / psi]
	EA	BA	EA	BA	EA	BA	
6		0.61		8.71		30.87	650 / 9,430
8		1.47		20.99		74.39	600 / 8,700
12		2.93		41.85		148.28	600 / 8,700
16		5.03		71.84		254.55	600 / 8,700
20		7.37		105.26		372.97	600 / 8,700

One side self-sealing (EA). Both sides self-sealing (BA). The pressure values are applicable at a temperature of 20°C. Please inquire about other temperature ranges.

Stated maximum permissible operating pressures (p max. permissible static) only apply to materials specified by us and to operation with group II media according to directive 2014/68/EU. Material combinations, optional materials, as well as other media or other temperature ranges can lead to divergent maximum permissible operating pressures and must be requested separately.

Please note that the maximum permissible operating pressure of the connection and quick coupling system must be considered when determining the operating pressure. Our safety instructions must be followed.

◀◀ The **performance diagram** can be found on the front catalogue fold-out page.

A detailed **connection description** can be found on the back catalogue fold-out page. ▶▶

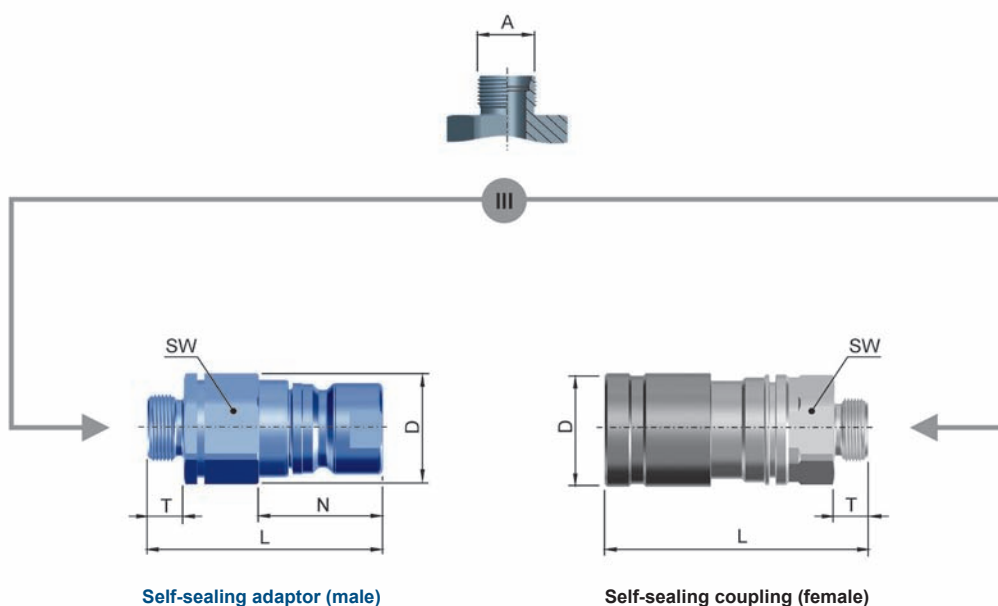



## Series HC

### Features chart | Quick coupling systems

	Product features	WEDISO	Additional options
Standard	<ul style="list-style-type: none"> <li>- Low leakage volume during disconnection</li> <li>- Automatic locking (one-hand operation)</li> <li>- Non-squirting</li> <li>- Connection without air inclusion</li> <li>- Full operating pressure even while disconnected</li> <li>- Flat surfaces for easy cleaning</li> </ul>	<b>Material</b> Galvanised steel, stainless steel, yellow-chromated, Locking sleeve: black phosphated = WEDISO  All self-sealing couplings AABA, all self-sealing adaptors AABB  <b>Special seals</b> suitable for mineral oil-based pressurised fluids, HFA and HFB fluids	Z10 = Basic design Z11 = Pressure relief valve Z12 = Additional dirt protection
Optional		Full stainless steel version	

For example, a complete part number looks like this:

**HC-G06-0-S1018-WEDISO-Additional options-Y../-Z..**

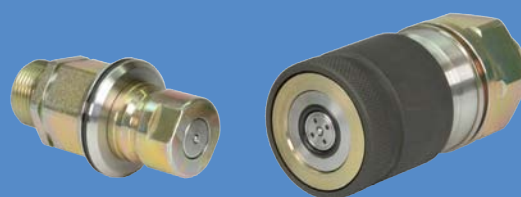

### Product chart | Quick coupling systems

Self-sealing adaptor marked in blue

NB	Product type	A	De-sign	Ran-ge	Pipe AD	Pipe ID	SW	T	D	L	N	Weight Steel	Material-neutral part number
6	Self-sealing coupling (female)	M 18 x 1.5	III	S	10	6	27	12	34	98.8		455	HC-G06-0-S1018-....-Z10
6	Self-sealing adaptor (male)	M 18 x 1.5	III	S	10	6	27	12	30.1	69	23.4	177	HC-G06-2-S1018-....-Z10
8	Self-sealing coupling (female)	M 20 x 1.5	III	S	12	8	32	12	42.4	104.8		660	HC-G08-0-S1220-....-Z10
8	Self-sealing adaptor (male)	M 20 x 1.5	III	S	12	8	27	12	30.1	69.2	26.8	220	HC-G08-2-S1220-....-Z10

NB - Nominal bore [mm] A - Connection SW - Wrench size [mm] T - Thread length [mm] D - Diameter [mm] L - Length [mm] N - Adaptor length [mm] Weight [g]



## Series HC

### Product chart | Quick coupling systems

Self-sealing adaptor marked in blue

NB	Product type	A	De- sign	Ran- ge	Pipe AD	Pipe ID	SW	T	D	L	N	Weight Steel	Material-neutral part number
12	Self-sealing coupling (female)	M 24 x 1.5	III	S	16	12	41	14	47.2	102.6		818	HC-G12-0-S1624-.....Z10
12	Self-sealing adaptor (male)	M 24 x 1.5	III	S	16	12	30	14	33.5	74.2	28.5	251	HC-G12-2-S1624-.....Z10
16	Self-sealing coupling (female)	M 30 x 2	III	S	20	16	50	16	57.8	112.4		1,406	HC-G16-0-S2030-.....Z10
16	Self-sealing adaptor (male)	M 30 x 2	III	S	20	16	41	16	45.6	80.4	31	487	HC-G16-2-S2030-.....Z10
20	Self-sealing coupling (female)	M 36 x 2	III	S	25	20	50	18	63.2	145.6		2,005	HC-G20-0-S2536-.....Z10
20	Self-sealing adaptor (male)	M 36 x 2	III	S	25	20	46	18	51.2	111.5	36	909	HC-G20-2-S2536-.....Z10

NB - Nominal bore [mm] A - Connection SW - Wrench size [mm] T - Thread length [mm] D - Diameter [mm] L - Length [mm] N - Adaptor length [mm] Weight [g]



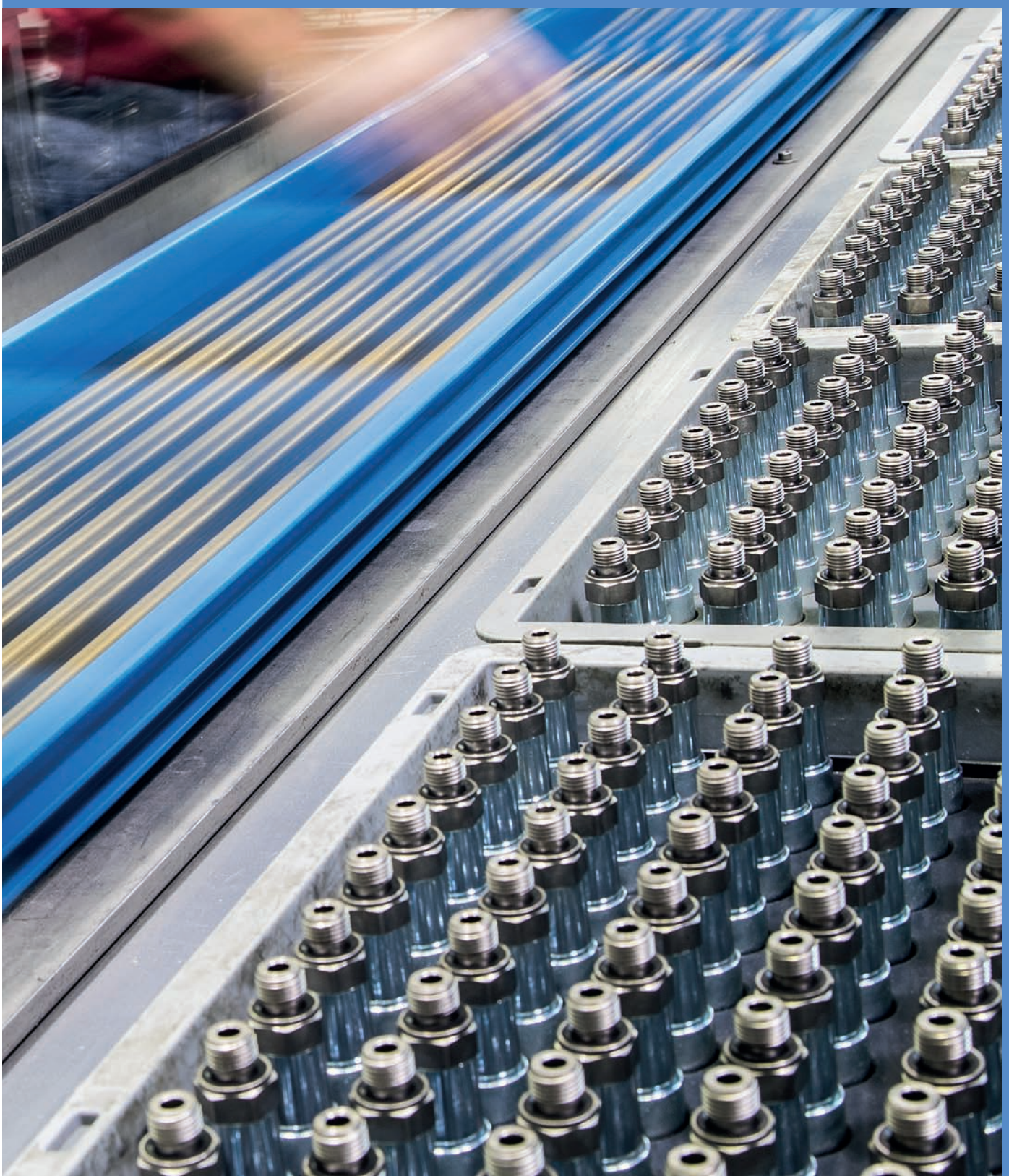



# Series HP



## Technical chart | Quick coupling systems

Nominal bore [mm]	Cv value		Q [L/min] water 20 °C, Δp = 1 bar		Q [m³/h] air 6 bar, 20 °C, Δp = 1 bar		p max. permissible static [bar / psi]		
	EA	BA	EA	BA	EA	BA	Steel	Stainless steel	Stainless steel 1.4404/1.4571 with 1.4418 QT900*
							coupled	coupled	coupled
4	0.40	0.20	5.71	3.43	20.24	12.15	2,000 / 29,000	520 / 7,540	1,000 / 14,500
6	1.00	0.70	14.28	9.28	50.61	32.89	1,000 / 14,500	345 / 5,000	690 / 10,000
10	2.50	1.90	35.70	27.13	126.52	96.15	600 / 8,700	345 / 5,000	520 / 7,540
16	8.10	5.50	115.68	78.55	409.92	278.34	500 / 7,250	250 / 3,625	450 / 6,530
20	13.00	8.50	185.65	121.39	657.89	430.16	400 / 5,800	210 / 3,045	350 / 5,080
32	29.40	23.80	419.86	339.89	1,487.84	1,204.44	300 / 4,350	210 / 3,045	250 / 3,625
50		65.00		928.27		3,289.44	200 / 2,900		

One side self-sealing (EA). Both sides self-sealing (BA). The pressure values are applicable at a temperature of 20°C. Please inquire about other temperature ranges.  
 \* For seawater-resistant designs, material 1.4418 can be replaced with S 20910/1.3964.  
 Special designs for 1000 or 690 bar are available up to NB 20.

Stated maximum permissible operating pressures (p max. permissible static) only apply to materials specified by us and to operation with group II media according to directive 2014/68/EU. Material combinations, optional materials, as well as other media or other temperature ranges can lead to divergent maximum permissible operating pressures and must be requested separately.

Please note that the maximum permissible operating pressure of the connection and quick coupling system must be considered when determining the operating pressure. Our safety instructions must be followed.

◀◀ The **performance diagram** can be found on the front catalogue fold-out page.

A detailed **connection description** can be found on the back catalogue fold-out page. ▶▶

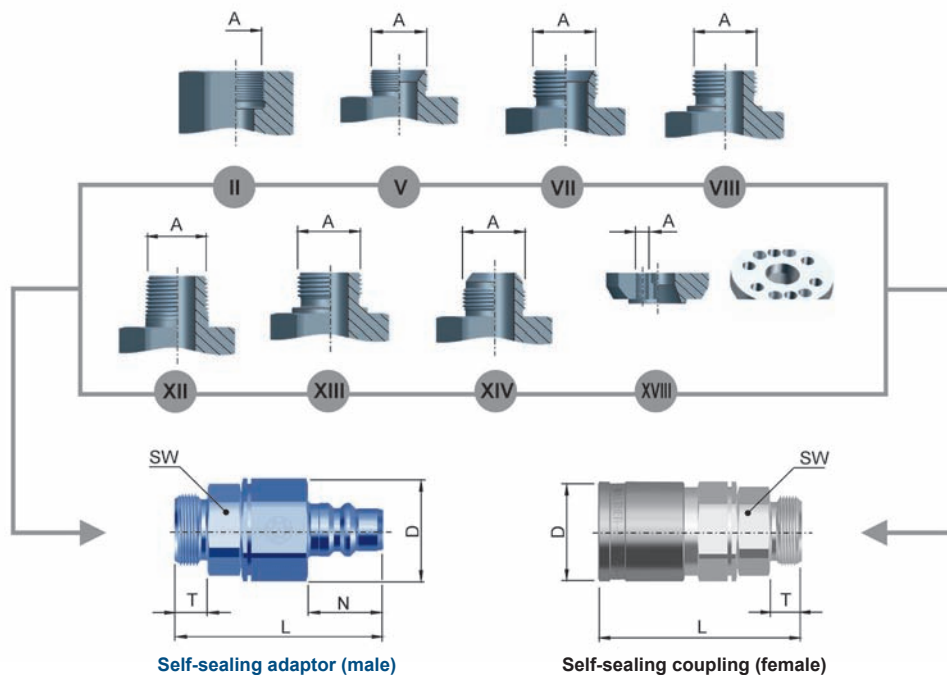





## Features chart | Quick coupling systems

	Product features	Materials	Seals	Additional options
Standard		12 = Steel oil burnished	1 = NBR 2 = FKM 4 = EPDM	<b>From HP-006</b> OV = Without valve SI* = Additional axial safety locking device RV = With ring valve (cannot be coupled with standard valves) Recommended for high pulsating pressures and harsh operating conditions  <b>HP-020</b> GG = With ring grips Ø 130 (aluminium cast)  <b>HP-032</b> GG = With ring grips Ø 190 (aluminium cast)  <b>HP-050</b> GG = With ring grips Ø 220 (aluminium cast)
Optional	- Vibration safety device - Suitable for high pressure reversal (up to 1 million)	01 = Stainless steel 1.4404/1.4571 or similar 13 = Steel chemically nickel plated W1 = 1.4404/1.4571, Self-sealing adaptor-fore-part 1.4418 QT900		

\*HP-006: SI – Outside diameter 38 mm    HP-010: SI – Outside diameter 50 mm    HP-016: SI – Outside diameter 62 mm  
 HP-020: SI – Outside diameter 68 mm    HP-032: SI – Outside diameter 96 mm

**Note:** For Type HP-010, Type 12-010 is the second non-interchangeable version available.

**Attention:** GG and SI cannot be combined = Special version - please enquire

**Attention:** Self-sealing coupling + OV ≙ Product type Thru-type coupling; Self-sealing adaptor + OV ≙ Product type Thru-type adaptor

For example, a complete part number looks like this:

**HP-004-0-NP013-Material-Seal-Additional options-Y./-Z..**



## Product chart | Quick coupling systems

Self-sealing adaptor / thru-type adaptor marked in blue

NB	Product type	A	De-sign	Ran-ge	Pipe AD	Pipe ID	SW	T	D	L	N	Weight Steel	Material-neutral part number
4	Self-sealing coupling (female)	NPT 1/4"	XII				22	14	30	71.5		220	HP-004-0-NP013-...

NB - Nominal bore [mm]    A - Connection    SW - Wrench size [mm]    T - Thread length [mm]    D - Diameter [mm]    L - Length [mm]    N - Adaptor length [mm]    Weight [g]



# Series HP

## Product chart | Quick coupling systems

Self-sealing adaptor / thru-type adaptor marked in blue

NB	Product type	A	De- sign	Ran- ge	Pipe AD	Pipe ID	SW	T	D	L	N	Weight Steel	Material-neutral part number
4	Self-sealing coupling (female)	NPT 1/4"	XIII				22	14	30	68.5		230	HP-004-0-NP513-...-
4	Self-sealing coupling (female)	BSPP 1/4 A with 60° sealing cone	VII			2	22	12	30	69.5		220	HP-004-0-XX001-...-
4	Self-sealing coupling (female)	UNF 9/16 with 58° sealing cone	XIV			2	22	18	30	75.5		220	HP-004-0-XX002-...-
4	Thru-type adaptor (male)	UNF 9/16 with 58° sealing cone	XIV			2	17	18	18.9	51	25.5	45	HP-004-1-XX002-...-
4	Self-sealing adaptor (male)	NPT 1/4"	XII				22	14	30	71.5	25.5	160	HP-004-2-NP013-...-
4	Self-sealing adaptor (male)	NPT 1/4"	XIII				22	14	30	68.5	25.5	170	HP-004-2-NP513-...-
4	Self-sealing adaptor (male)	BSPP 1/4 A with 60° sealing cone	VII			2	22	12	30	69.5	25.5	160	HP-004-2-XX001-...-
4	Self-sealing adaptor (male)	UNF 9/16 with 58° sealing cone	XIV			2	22	18	30	75.5	25.5	160	HP-004-2-XX002-...-
6	Self-sealing coupling (female)	M 14 x 1.5	V			6	30	10	34	75.5		300	HP-006-0-D0614-...-
6	Self-sealing coupling (female)	M 16 x 1.5	V			8	30	11	34	76.5		300	HP-006-0-D0816-...-
6	Self-sealing coupling (female)	NPT 3/8"	XII			6	30	15	34	80.5		260	HP-006-0-NP017-...-
6	Self-sealing coupling (female)	NPT 3/8"	XIII			6	30	15	34	81.5		320	HP-006-0-NP517-...-
6	Self-sealing coupling (female)	M 16 x 1.5	III	S	8	4	30	12	34	77.5		320	HP-006-0-S0816-...-
6	Self-sealing coupling (female)	M 18 x 1.5	III	S	10	6	30	12	34	77.5		310	HP-006-0-S1018-...-
6	Self-sealing coupling (female)	M 20 x 1.5	III	S	12	8	30	12	34	77.5		330	HP-006-0-S1220-...-
6	Self-sealing coupling (female)	BSPP 3/8"	VII			6	30	12	34	77.5		250	HP-006-0-VR017-...-
6	Self-sealing coupling (female)	BSPP 3/8"	VIII			6	30	12	34	80		320	HP-006-0-WB017-...-
6	Self-sealing coupling (female)	BSPP 3/8"	II			6	30	15	34	75		350	HP-006-0-WR517-...-
6	Thru-type adaptor (male)	BSPP 3/8"	VIII			6	22	12	25	54	30.5	70	HP-006-1-WB017-...-
6	Self sealing adaptor (male)	M 14 x 1.5	V			6	30	10	34	75.5	30.5	190	HP-006-2-D0614-...-

NB - Nominal bore [mm] A - Connection SW - Wrench size [mm] T - Thread length [mm] D - Diameter [mm] L - Length [mm] N - Adaptor length [mm] Weight [g]

**Product chart | Quick coupling systems**

Self-sealing adaptor / thru-type adaptor marked in blue

NB	Product type	A	De- sign	Ran- ge	Pipe AD	Pipe ID	SW	T	D	L	N	Weight Steel	Material-neutral part number
6	Self-sealing adaptor (male)	M 16 x 1.5	V			8	30	11	34	76.5	30.5	190	HP-006-2-D0816-...
6	Self-sealing adaptor (male)	NPT 3/8"	XII			6	30	15	34	80.5	30.5	220	HP-006-2-NP017-...
6	Self-sealing adaptor (male)	NPT 3/8"	XIII			6	30	15	34	81.5	30.5	240	HP-006-2-NP517-...
6	Self-sealing adaptor (male)	M 16 x 1.5	III	S	8	4	30	12	34	77.5	30.5	210	HP-006-2-S0816-...
6	Self-sealing adaptor (male)	M 18 x 1.5	III	S	10	6	30	12	34	77.5	30.5	200	HP-006-2-S1018-...
6	Self-sealing adaptor (male)	M 20 x 1.5	III	S	12	8	30	12	34	77.5	30.5	220	HP-006-2-S1220-...
6	Self-sealing adaptor (male)	BSPP 3/8"	VII			6	30	12	34	77.5	30.5	210	HP-006-2-VR017-...
6	Self-sealing adaptor (male)	BSPP 3/8"	VIII			6	30	12	34	80	30.5	210	HP-006-2-WB017-...
6	Self-sealing adaptor (male)	BSPP 3/8"	II			6	30	15	34	75	30.5	270	HP-006-2-WR517-...
10	Self-sealing coupling (female)	M 18 x 1.5	V			10	41	11	46	91.5		670	HP-010-0-D1018-...
10	Self-sealing coupling (female)	M 22 x 1.5	V			12	41	12	46	92.5		670	HP-010-0-D1222-...
10	Self-sealing coupling (female)	NPT 1/2"	XIII			10	41	18	46	100.5		850	HP-010-0-NP521-...
10	Self-sealing coupling (female)	M 20 x 1.5	III	S	12	8	41	12	46	92.5		670	HP-010-0-S1220-...
10	Self-sealing coupling (female)	M 22 x 1.5	III	S	14	10	41	14	46	94.5		670	HP-010-0-S1422-...
10	Self-sealing coupling (female)	M 24 x 1.5	III	S	16	12	41	14	46	94.5		680	HP-010-0-S1624-...
10	Self-sealing coupling (female)	BSPP 1/2"	VII			10	41	15	46	95.5		680	HP-010-0-VR021-...
10	Self-sealing coupling (female)	BSPP 1/2"	VIII			10	41	17	46	97.5		690	HP-010-0-WB021-...
10	Self-sealing coupling (female)	BSPP 1/2"	II			10	41	17	46	96.5		840	HP-010-0-WR521-...
10	Thru-type adaptor (male)	BSPP 1/2"	VIII			10	27	17	30	63	36	130	HP-010-1-WB021-...
10	Self-sealing adaptor (male)	M 18 x 1.5	V			10	41	11	46	91.5	36	450	HP-010-2-D1018-...
10	Self-sealing adaptor (male)	M 22 x 1.5	V			12	41	12	46	92.5	36	450	HP-010-2-D1222-...
10	Self-sealing adaptor (male)	NPT 1/2"	XIII			18	41	18	46	100.5	36	630	HP-010-2-NP521-...

NB - Nominal bore [mm] A - Connection SW - Wrench size [mm] T - Thread length [mm] D - Diameter [mm] L - Length [mm] N - Adaptor length [mm] Weight [g]



# Series HP

## Product chart | Quick coupling systems

Self-sealing adaptor / thru-type adaptor marked in blue

NB	Product type	A	De- sign	Ran- ge	Pipe AD	Pipe ID	SW	T	D	L	N	Weight Steel	Material-neutral part number
10	Self-sealing adaptor (male)	M 20 x 1.5	III	S	12	8	41	12	46	92.5	36	460	HP-010-2-S1220-...
10	Self-sealing adaptor (male)	M 22 x 1.5	III	S	14	10	41	14	46	94.5	36	460	HP-010-2-S1422-...
10	Self-sealing adaptor (male)	M 24 x 1.5	III	S	16	12	41	14	46	94.5	36	470	HP-010-2-S1624-...
10	Self-sealing adaptor (male)	BSPP 1/2"	VII			10	41	15	46	95.5	36	460	HP-010-2-VR021-...
10	Self-sealing adaptor (male)	BSPP 1/2"	VIII			10	41	17	46	97.5	36	470	HP-010-2-WB021-...
10	Self-sealing adaptor (male)	BSPP 1/2"	II			10	41	17	46	96.5	36	620	HP-010-2-WR521-...
16	Self-sealing coupling (female)	M 22 x 1.5	V			12	46	12	56	108.5		1,110	HP-016-0-D1222-...
16	Self-sealing coupling (female)	M 24 x 1.5	III	S	16	12	46	14	56	110.5		1,120	HP-016-0-S1624-...
16	Self sealing coupling (female)	M 30 x 2	III	S	20	16	46	16	56	112.5		1,140	HP-016-0-S2030-...
16	Self-sealing coupling (female)	BSPP 3/4"	VII			16	46	17	56	113.5		1,130	HP-016-0-VR026-...
16	Self-sealing coupling (female)	BSPP 3/4"	VIII			16	46	19	56	115.5		1,140	HP-016-0-WB026-...
16	Self-sealing coupling (female)	BSPP 3/4"	II			16	46	19	56	110.5		1,360	HP-016-0-WR526-...
16	Thru-type adaptor (male)	BSPP 3/4"	VIII			12	36	19	41	72	41	250	HP-016-1-WB026-..
16	Self-sealing adaptor (male)	M 22 x 1.5	V			12	46	12	56	107.5	41	760	HP-016-2-D1222-...
16	Self-sealing adaptor (male)	M 24 x 1.5	III	S	16	12	46	14	56	109.5	41	770	HP-016-2-S1624-...
16	Self-sealing adaptor (male)	M 30 x 2	III	S	20	16	46	16	56	111.5	41	790	HP-016-2-S2030-...
16	Self-sealing adaptor (male)	BSPP 3/4"	VII			16	46	17	56	112.5	41	780	HP-016-2-VR026-...
16	Self-sealing adaptor (male)	BSPP 3/4"	VIII			16	46	19	56	114.5	41	790	HP-016-2-WB026-...
16	Self-sealing adaptor (male)	BSPP 3/4"	II			16	46	19	56	109.5	41	1,000	HP-016-2-WR526-...
20	Self-sealing coupling (female)	M 26 x 1.5	V			15	55	12	62	110.5		1,400	HP-020-0-D1526-...
20	Self-sealing coupling (female)	M 30 x 1.5	V			19	55	14	62	112.5		1,410	HP-020-0-D1930-...
20	Self-sealing coupling (female)	M 36 x 2	III	S	25	20	55	18	62	116.5		1,440	HP-020-0-S2536-...

NB - Nominal bore [mm] A - Connection SW - Wrench size [mm] T - Thread length [mm] D - Diameter [mm] L - Length [mm] N - Adaptor length [mm] Weight [g]



**Product chart | Quick coupling systems**

Self-sealing adaptor / thru-type adaptor marked in blue

NB	Product type	A	De- sign	Ran- ge	Pipe AD	Pipe ID	SW	T	D	L	N	Weight Steel	Material-neutral part number
20	Self-sealing coupling (female)	BSPP 1"	VII			20	55	20	62	118.5		1,450	HP-020-0-VR033-...
20	Self-sealing coupling (female)	BSPP 1"	VIII			20	55	21	62	119.5		1,450	HP-020-0-WB033-...
20	Self-sealing coupling (female)	BSPP 1"	II			20	55	23	62	123		1,720	HP-020-0-WR533-...
20	Thru-type adaptor (male)	BSPP 1"	VIII			20	41	21	45	74	43	310	HP-020-1-WB033-...
20	Self-sealing adaptor (male)	M 26 x 1.5	V			15	55	12	62	110.5	43	1,030	HP-020-2-D1526-...
20	Self-sealing adaptor (male)	M 30 x 1.5	V			19	55	14	62	112.5	43	1,040	HP-020-2-D1930-...
20	Self-sealing adaptor (male)	M 36 x 2	III	S	25	20	55	18	62	116.5	43	1,060	HP-020-2-S2536-...
20	Self-sealing adaptor (male)	BSPP 1"	VII			20	55	20	62	118.5	43	1,070	HP-020-2-VR033-...
20	Self-sealing adaptor (male)	BSPP 1"	VIII			20	55	21	62	119.5	43	1,070	HP-020-2-WB033-...
20	Self-sealing adaptor (male)	BSPP 1"	II			20	55	23	62	123	43	1,340	HP-020-2-WR533-...
32	Self-sealing coupling (female)	M 38 x 2	V			25	80	14	90	133.5		3,690	HP-032-0-D2538-...
32	Self-sealing coupling (female)	M 45 x 1.5	V			32	80	16	90	135.5		3,680	HP-032-0-D3245-...
32	Self-sealing coupling (female)	M 52 x 2	III	S	38	32	80	22	90	141.5		3,790	HP-032-0-S3852-...
32	Self-sealing coupling (female)	BSPP 1 1/2"	VIII			32	80	25	90	144.5		3,790	HP-032-0-WB048-...
32	Thru-type adaptor (male)	BSPP 1 1/2"	VIII			32	55	25	61.5	90.5	49.5	690	HP-032-1-WB048-...
32	Thru-type adaptor (male)	BSPP 2"	VIII			32	75	27	86	92.5	49.5	1,190	HP-032-1-WB060-...
32	Self-sealing adaptor (male)	M 38 x 1.5	V			25	80	14	90	133	49.5	2,630	HP-032-2-D2538-...
32	Self-sealing adaptor (male)	M 45 x 1.5	V			32	80	16	90	135	49.5	2,620	HP-032-2-D3245-...
32	Self-sealing adaptor (male)	M 52 x 2	III	S	38	32	80	22	90	141	49.5	2,730	HP-032-2-S3852-...
32	Self-sealing adaptor (male)	BSPP 1 1/2"	VIII			32	80	25	90	144	49.5	2,740	HP-032-2-WB048-...
50	Self-sealing coupling (female)	SAE-flange	XVIII		65	50			150	219		15,300	HP-050-0-XX007-...
50	Self-sealing adaptor (male)	SAE-flange	XVIII		65	50			150	217.5	87.5	11,400	HP-050-2-XX007-...

NB - Nominal bore [mm] A - Connection SW - Wrench size [mm] T - Thread length [mm] D - Diameter [mm] L - Length [mm] N - Adaptor length [mm] Weight [g]



Our tailor-made systems are used wherever unusual requirements for quick coupling systems are presented, such as temperatures (-273°C up to +310°C), purity grades (SIP or CIP capability), special media (steam, lacquers, glues, medical gases, alkalis and acids), information technology (indicators or "proximity", RFID), where customer cavities need to be used, emergency release units, and much more. We develop quick coupling systems - specifically for you!



## Tailor-made quick coupling systems

### Product Finder

Clean break valve designs marked in green

Typical applications	Features + options	Maximum permissible static pressure* [bar / psi]	Standard temperature** [°C]	Product	Page
Enamel coupling	For synthetic resin-, nitro- and water-based paints and lacquers, Byonet latching	140 / 2,030	+10 to +40	<b>03-005</b>	148
Inhaled air, protective masks, medical sector	With pull-off safety device, automatic locking (one-hand operation), ATEX-compliant	23 / 333	-30 to +150	<b>04-005</b>	148
Water supply for dialysis filter	Color coding for inlet outlet identification	6 / 87	+10 to +40	<b>22-006</b>	149
Sterile applications	SIP-/CIP-capable for sampling, FDA-compliant, automatic locking	16 / 232	+20 to +130	<b>33-005</b>	149
Subassembly elements for hydraulics and emulsion	For direct incorporation into customer cavities	240 / 3,480	-15 to +200	<b>57 / 85</b>	150
Medical gas supply	Different closures depending on the profiles of gas, to international standards	35 / 508	+10 to +40	<b>89-006</b>	150
High-temperature/ high-pressure chemistry	Stainless steel with special seals	350 / 5,075	+250	<b>DD</b>	151
Optical non-interchangeability	Colour coding			<b>Various series</b>	151
Fuelling, chemistry, steel industry	Non-destructive emergency-release			<b>Various series</b>	152
Chemistry, fuelling, loading	RFID technology			<b>Various series</b>	152
Refuelling system for gaseous hydrogen	Thermally insulated outer shell, 70 MPa to SAE J2600 and SAE J2799	875 / 12,690	-40 to +85	<b>HG-004</b>	153
Offshore	Screw type coupling - suitable for divers	690 / 10,000	-15 to +200	<b>SH</b>	153
Steam cleaning, sterilisation	All seals made of PTFE	40 / 580	-196 to +250	<b>TE</b>	154
Cryogenics, low-temperature	With catch-locking, specifically for liquefied gases	16 / 232	-196 to +80	<b>TT</b>	154
Quick connect coupling	With automatic locking, replacement for screwed connection	250 / 3,625	-20 to +200	<b>WK</b>	155

\* The max. permissible static pressure depends on the chosen technical version.

\*\* The suitability for temperature depends on the medium, operating pressure and the quick coupling materials used.

We would be happy to provide you with support and advice. Please contact us:



+49 (0) 2129 / 567-405



tk@walther-praezision.de





## Tailor-made quick coupling systems

### Lacquer coupling Type 03-005

**Description:**

Suitable for synthetic resins, nitrocellulose and water soluble lacquers in paint shops, paint, lacquer and solvent processing companies, the automotive industry, the furniture industry, machine and apparatus construction, handcraft and repair shops

**Advantages:**

Easy to clean, robust coupling with self-closing ball valve and bayonet locking, free of lacquer flow disturbing substances

**Options:**

Various connection types, optionally also available as high-pressure version up to 200 bar / 2,900 psi

**Construction:**

**Material combinations** of stainless steel, brass or chemically nickel-plated steel

**Seal:** Polyamide (PA)



### Breathing air coupling Type 04-005

**Description:**

Suitable for breathing air applications in various areas, e.g. on respirators for fire brigades, in dusty environments, in laboratories and research institutes or for divers

**Advantages:**

One side sealing coupling unit with automatic locking and integrated automatic pull-off safety device.

Disconnection is only possible by pressing in the thru-type adaptor into the coupling housing while simultaneously pulling back the locking sleeve (safety feature against unintentional disconnection), grip beads facilitate handling with gloves.

**Options:**

Different connection types, non-interchangeable variants (coding), ATEX compliant

**Construction:**

**Material:** Stainless steel 1.4404/1.4571 or equivalent or chromium-plated brass

**Seal:** EPDM







## Tailor-made quick coupling systems



Fresenius SE

### Dialysis coupling Type 22-006

**Description:**

Suitable for safe and easy-to-use filter change on dialysis machines or for the simple implementation of work processes (cleaning procedures)

**Advantages:**

Long-lasting and easy-to-clean design, FDA compliant, can be connected with internationally standardised adaptors

**Options:**

Different colour marking possible (flow and return flow) integrated connected/disconnected request options available

**Construction:**

**Material:** Polypropylene (PP), Polyvinylidene fluoride (PVDF), partly with stainless steel

**Seal:** EPDM and FKM / VQM, FDA compliant



### Sterile coupling Type 33-005

**Description:**

Suitable for sampling, supply, transfer of various highly sensitive liquids and process gases in the food and pharmaceutical industries

**Advantages:**

CIP (Cleaning-In-Place) - and SIP (Sterilization-In-Place) capable quick coupling systems with an almost dead-space-free internal design; also suitable for process media in the pharmaceutical industry

**Options:**

One side and both sides closing versions, different connection types (welding connection, tri-clamp, ...), special version with flushing function, FDA compliant

**Construction:**

**Material:** Stainless steel 1.4404, 1.4539, special materials on request

**Seal:** EPDM or FFKM



## Tailor-made quick coupling systems

### Clean break installation elements Series 57 and Series 85

**Description:**

For clamping hydraulics, blow-off air, cooling lubricant emulsions etc. and for installation in customer-specific cavities; specially adapted to the requirements of machine tools, versatile installation options due to high centre-deviation tolerance during connection and in space-saving construction

**Advantages:**

Compensation of customer misalignments by integral, high, centre and angular deviation tolerances, low-leakage valve technology, non-squirting, high coupling frequency possible, applicable for differential pressures up to 40 bar / 580 psi, compact and robust construction

**Options:**

Special materials on request

**Construction:**

**Material:** Burnished or chemically nickel-plated steel, stainless steel 1.4104

**Seal:** FKM

**Note:** Residual leakage quantities or coupling input volumes on request.



### Medical gas supply Type 89-006

**Description:**

For medical gas supply in hospitals, wards, medical practices. Self-sealing coupling and thru-type adaptor with 45° hose outlet according to German, French, British and other standards

**Advantages:**

Solid metallic construction, elegant, various standards (DIN, BS, AFNOR, and many more), FDA compliant materials, free of oil and grease (FF)

**Options:**

Non-interchangeable variants for O<sub>2</sub>, air, vacuum, N<sub>2</sub>O, CO<sub>2</sub>, angled adaptor optional with venting check valve, antibacterial version

**Construction:**

**Materials:** Nickel-plated brass, stainless steel, hard-coated aluminium

**Seal:** EPDM







## Tailor-made quick coupling systems



### Clean Break high pressure and high temperature coupling Series DD

**Description:**

Designed for use in high-temperature chemistry, for high-temperature hydraulic applications, for synthesis processes and for special areas of petrochemistry and - depending on the nominal bore - for operating pressures up to 350 bar / 5,075 psi

**Advantages:**

Applicable for critical gases and liquids up to 250°C, especially when combined with high pressures and high temperatures

**Options:**

Different connection types, unlocking safety device ST, ring grips (from NB 16 mm), ATEX compliant

**Construction:**

**Material:** Stainless steel 1.4404/1.4571 or higher  
**Seal:** FFKM



### Colour coding of coupling systems

**Description:**

Colour coding can be an advantage in the differentiation of different line systems. Accordingly, both the coupling and adaptor ends can be supplied with a corresponding colour code. However, this does not completely prevent any potential confusion. We therefore strongly advise the use of mechanical coding (such as series UF)!

**Advantages:**

Optical coding of different lines reduces the frequency of errors and resulting costs.

**Options:**

Ideally supplemented with mechanical coding that absolutely rules out any confusion!

**Construction:**

Available in assorted variants for different series



## Tailor-made quick coupling systems

### Emergency-release couplings

**Description:**

Emergency-release couplings (sometimes also referred to as break-away couplings) disconnect fully automatically and non-destructively once a defined separation force has been exceeded. The valves close automatically immediately upon separation and prevent the medium from leaking out of the separated line segments. Separation without a traction cable: Unanticipated tractive forces that occur are routed through a hose onto the locking/unlocking sleeve designed for this purpose. Separation via a separate traction cable: Unanticipated tractive forces that occur are routed to the locking/unlocking sleeve via a traction cable that runs parallel to the hose.

**Advantages:**

Significant reduction in risks to people and the environment, non-destructive (operational again immediately after use), tailored to the relevant customer situation in terms of nominal bore, valve technology and version



### Special versions with RFID

**Description:**

Almost all variants of Walther quick coupling systems can be combined with innovative Radio Frequency Identification (RFID) technology. This allows data from one part of the coupling point to be transmitted wirelessly to the other parts of the coupling point.

**Advantages:**

The wireless connection enables a direct connection to be established with the plant control system. No additional energy supply is needed for the transponder side to achieve this (supply via antenna). Both retrieval and storage of data can be carried out on the transponder. This opens up completely new horizons of the plant control system and documentation.

**Construction:**

Different material and design versions depending on the coupling type

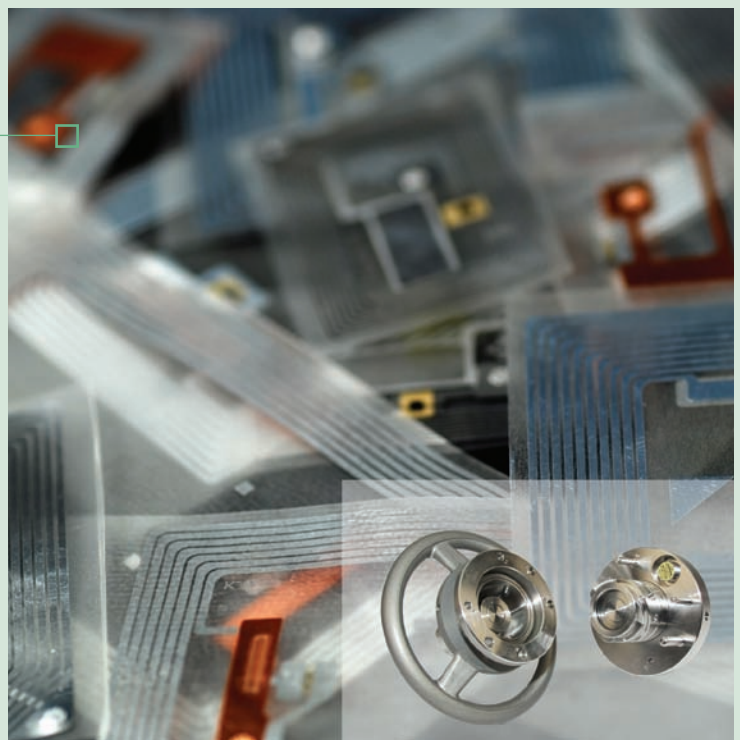





## Tailor-made quick coupling systems



### Fuelling coupling for hydrogen Type HG-004

**Description:**

The high pressure fuelling coupling has been developed for the fuelling of motor vehicles with gaseous hydrogen up to an operating pressure of 875 bar / 12,690 psi (700 bar / 10,150 psi technology).

**Advantages:**

Suitable for ULTRA COLD FILL (gas temperature -40°C), pressure-active axial safety locking device, simple and reliable push-pull operation, robust and certified electro plug for transmission of infra-red signals

**Options:**

Various connection types, Atex and CE compliant complete system consisting of high pressure refuelling adaptor, high pressure coupling, emergency release coupling and hose line available

**Construction:**

**Material:** Stainless steel, insulating body made from special plastic material

**Seal:** Special sealing technology, hydrogen-resistant



### Underwater coupling Series SH

**Description:**

For high pressure applications up to 690 bar (10,000 psi) in underwater environments, can be used for connection to machines as well as a hose extension

**Advantages:**

Can be connected and disconnected under pressure, redundant sealing with metal seals, blind-coupling by special ergonomic design, optimum handling due to low torque

**Options:**

Mechanical coding, pressure tight dust caps and plugs available

**Construction:**

**Material:** 1.4404 or higher

**Seal:** Metallic seal, FFKM, PTFE



## Tailor-made quick coupling systems

### High temperature coupling Series TE

**Description:**

For the highest stresses; robust, both sides self-sealing quick connect (self-sealing) coupling for extreme temperatures/media (-50°C to + 250°C) in the low pressure range (max. 100 bar, depending on the nominal bore and material version). Also suitable for steam up to 250°C and nitrogen down to -196°C.

**Advantages:**

Different connection types available, durable thanks to special sealing technology, resistant to aggressive media, e.g. non-squirting

**Options:**

Temperature-protected ring grips - marked in red, special elastomer-steam hose design (with venting feature) avoids the "popcorn effect"

**Construction:**

**Material:** Chemically nickel-plated steel, brass, stainless steel 1.4404/1.4571 or equivalent  
**Seal:** PTFE



### Low temperature coupling Series TT

**Description:**

For cryogenic applications at low temperatures down to -196°C (e.g. for liquid nitrogen) in the low pressure range (up to 16 bar / 232 psi)

**Advantages:**

Non-squirting, ergonomic simple handling due to automatic locking by means of catch locking, free of oil and grease (FF), robust and durable

**Options:**

Available with self-venting valve (VE), dust caps and plugs

**Construction:**

**Material:** Stainless steel, brass, plastic  
**Seal:** PTFE





## Tailor-made quick coupling systems

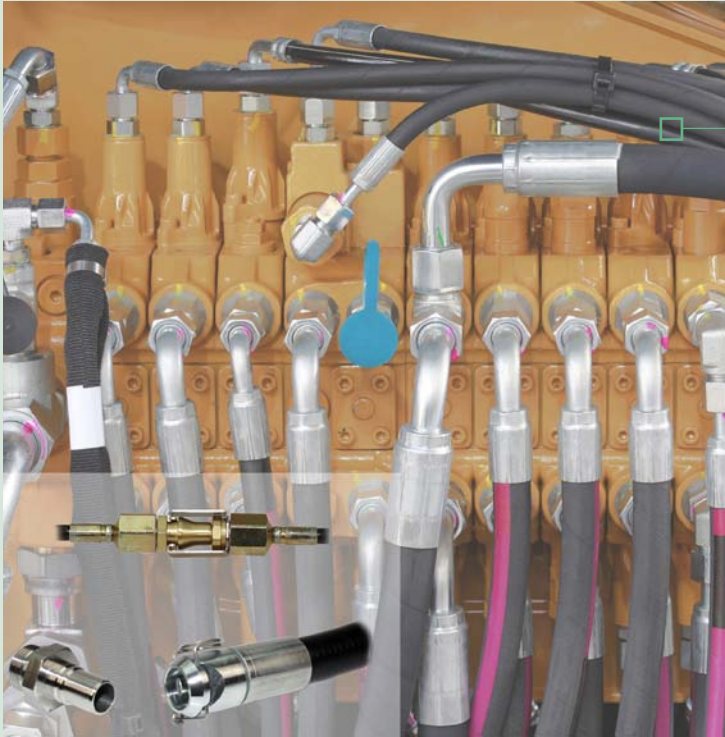

### Quick assembly coupling Series **WK**

**Description:**

For the easy connection of fluidic lines, especially in hard-to-reach areas, viable alternative to conventional screw connections

**Advantages:**

Faster, more efficient and secure connection of fluidic lines

**Options:**

Clear passage or one side or both sides closing, for low and medium pressure applications (up to 250 bar / 3,625 psi)

**Construction:**

**Material:** Galvanised steel, brass, hard-coated aluminium

**Seal:** NBR, FKM



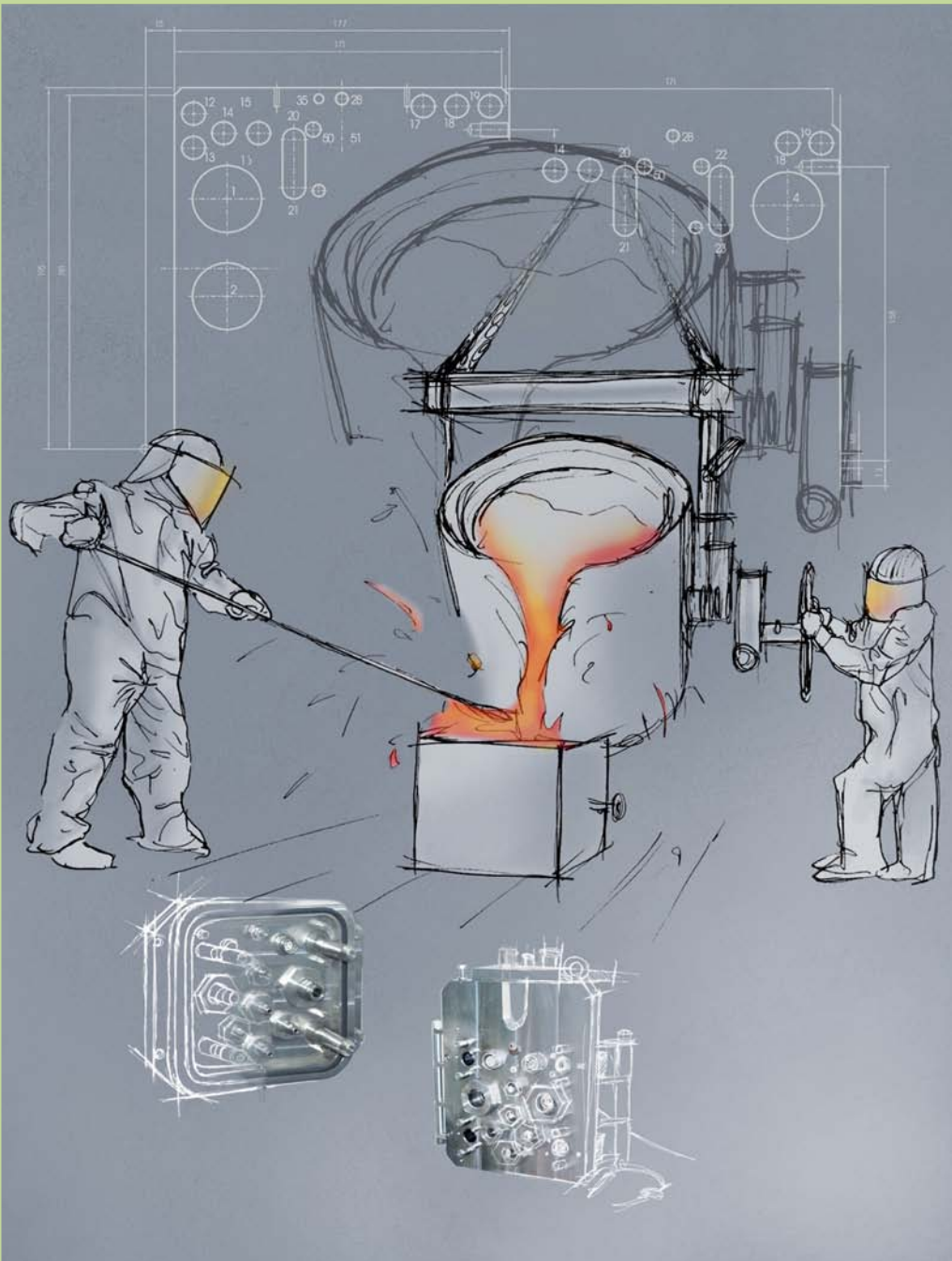

As soon as many different lines need to be connected together quickly, precisely and safely (and also non-interchangeably), multi-couplings (manually operable) or docking systems (power assisted operation) are the first choice. Elements for a variety of media and pressure ranges can be combined on the customised plates - increasingly often with electric control and power lines including information transfer (bus systems, fibre optic cables, etc.).





## Multi-couplings / Docking systems / Tool changers

### Multi-couplings for manual operation

Modular system Fluidic 158

Customer-specific configurable solutions 159

### Docking systems for automatic operation

Modular construction system 162

Customer-specific customisable solutions 163

### Tool changing systems for robots

Modular robot and tool interface 166

Parking station/accessories 167

We would be happy to provide you with support and advice. Please contact us:



+49 (0) 2129 / 567-405



tk@walther-praezision.de





## Multi-couplings for manual operation

### Multi-coupling in housing design

The modularly built plug system is used for quick and simple connection and separation of pneumatic compressed air and/or electric signal lines. For cooling lines, a both sides self-sealing clean break coupling element is available. The robust design with housing allows for use even in harsh environments.



Fluidic Multikupplungen & Zubehör	90405
Fluidic Multi Couplings & Accessoires	90408
	90410







## Multi-couplings for manual operation



Customer-specific configurable solutions

### Multi-coupling available in plate construction with simple handles and decentralised locking elements

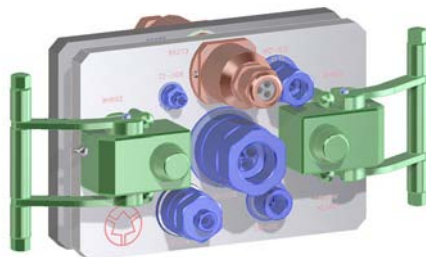
A wide variety of fluidic media are quickly, simply and non-interchangeably combined in a compact design. The coupling process takes place centrally via the carrier plate. The decentralised, mechanical locks absorb the reaction forces of the coupling elements. This design generally requires an unpressurised coupling and uncoupling process. Additional mechanical coding is possible.



Customer-specific configurable solutions

### Multi-coupling available in plate construction with power-assisted lever lock with/without unlocking assistance

Manual multi-couplings with a manual lever lock are generally couplings developed individually according to customer needs for all media and parameters. A wide variety of couplings are available, up to nominal bore 25 and electro plugs. Options such as mechanical coding, sensor scanning of the connection status, parking halves and protection covers are also available. To simplify the separation process, the use of an unlocking assistance is possible.



## Multi-couplings for manual operation

### Multi-coupling in compact design with central lock

A bundle of compressed air piping is quickly, simply and non-interchangeably interconnected in a compact design. The mechanical coupling process takes place centrally via an automatically engaging lock located in the centre of the plate.



### Multi-coupling available in plate construction with screw lock

In manual multi-couplings with a screw lock, locking can take place mechanically via one or several screws arranged on the plate. It is nonetheless also possible to integrate an external screw sleeve connection in the case of a compact multi-coupling design.





## Multi-couplings for manual operation



Customer-specific configurable solutions

### Multi-coupling available in plate construction with a swinging bolt lock

The manual multi-coupling with a swinging bolt lock is a special screw lock variant. This type of screw lock has proven itself in adverse conditions such as in the offshore industry.



Multikupplungen & Dockingsysteme  
Multi-Couplings & Docking Systems







## Docking systems for automatic operation

### Docking systems for flexible media transfer

With the progressive automation of production processes, the simultaneous and safe combination of different media such as compressed air, vacuum, cooling water and electrical connections for line current and signal data is becoming increasingly necessary. WALTHER has developed a multi-coupling system available in different sizes for a wide variety of applications that is flexibly and modularly applicable and configurable based on a modular design. Different plate sizes can combine the desired media quickly and non-interchangeably with or without a feed unit. Our system meets the applicable regulations of the automotive industry for the supply of clamping frames, rotary tables and for GeoSkid applications as well as automation tasks in mechanical and plant engineering.

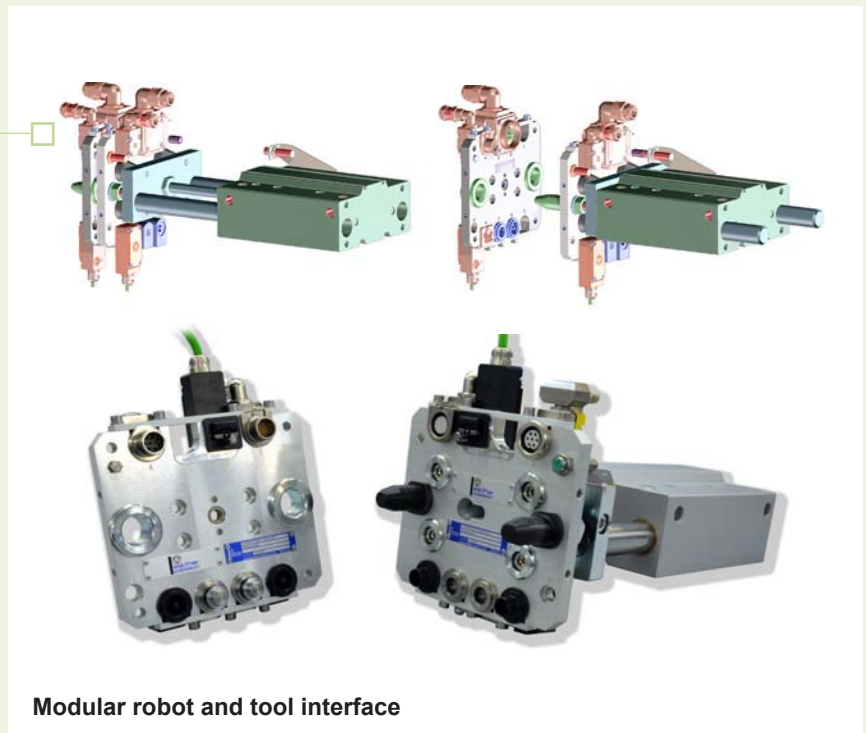

Modular robot and tool interface





## Docking systems for automatic operation

### Power-assisted docking systems without a feed unit



Customer-specific configurable solutions

Existing on-site motion sequences can be used for the coupling process in automation. Robust plate designs are chosen for this reason. Deviations in the feed movement must nonetheless be compensated for using suitable guidance and centering devices. A wide variety of coupling and electrical elements can also be combined with this design. The absorption of reaction forces of individual coupling elements takes place in the plant.

### Automatically operated docking systems with a feed unit

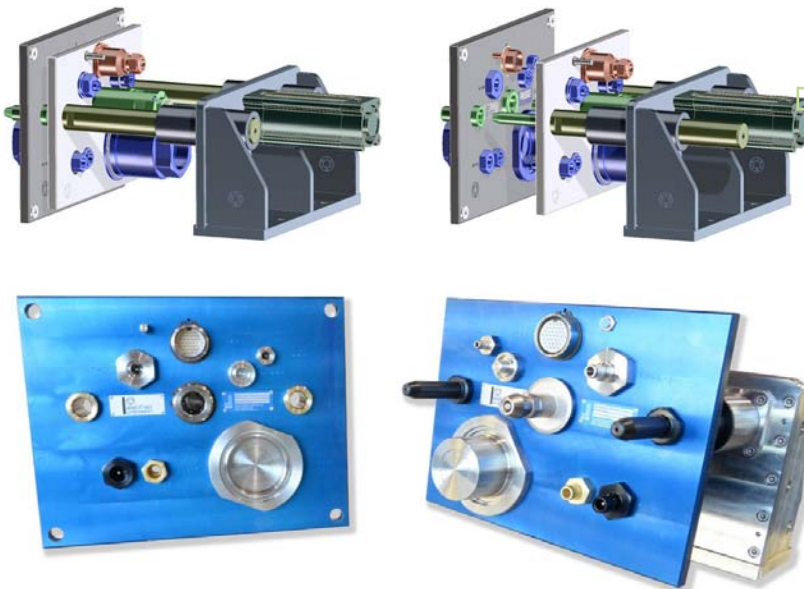

Customer-specific configurable solutions

When motion sequences of the existing plant peripherals cannot be relied upon during automation, the docking systems must be equipped with their own drives. Pneumatic or hydraulic cylinders or electric servomotors are generally used for this purpose. A wide variety of coupling and electrical elements can be combined even with such a design. Additional mechanical locks, which hold the plates together under full pressure loads, can be considered in the case of enhanced reaction forces. To integrate such a docking system into the control process of a customer plant, proximity switches can be provided to query the status of the coupling.



## Docking systems for automatic operation

### Automatically operated docking systems in a special feeding technique design

If the coupling and separating forces of a separately-powered docking system become too large and the on-site plant peripherals are unable to absorb these, docking systems with a special feeding technique design are available. This means that only the dead weight and docking force of the feed unit affect the plant peripherals. A wide variety of coupling and electrical elements can also be combined with this design. Mechanical locks are used in the case of enhanced reaction forces in order to hold the plates together under full pressure loads.

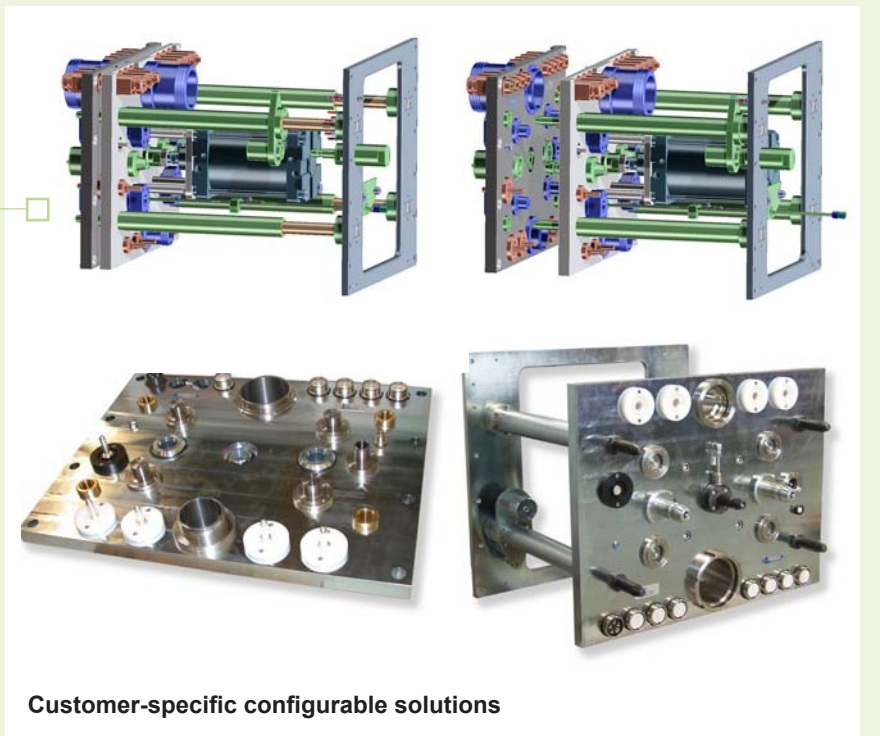



## Docking systems for automatic operation



Customer-specific configurable solutions

### Automatically operated docking systems in special spindle drive design

When motion sequences in automation need to be controlled very precisely, docking systems are equipped with a spindle drive. The spindle can be driven servo-pneumatically, hydraulically or electrically. Depending on the type of spindle, the reaction forces can be absorbed by the spindle itself or by separate mechanical locks. A wide variety of coupling elements can also be combined with this design.



Multikupplungen & Dockingsysteme  
Multi-Couplings & Docking Systems







## Tool changing systems for robots

### Robot and tool sides - TOOLmaster TM 500, TM 800, TM 1000

Tool changers are perfectly adapted to the requirements of modern industrial robots and highly efficient production cells. Our robots equipped with changers are capable of fulfilling different work tasks without a manual set-up time and of ensuring the maximum process safety with redundant tool concepts. The modular design guarantees the realisation of individual customer requirements. Applications exist in the automotive industry, as well as in other sectors. The changer can be optionally equipped with different electrical or fluidic elements depending on the intended use. For applications with an elevated load capacity, TOOLmaster 800 and/or 1000 are available.

Thanks to a modular design, a diverse range of add-on elements to the TOOLmaster 500 are available.

- Static load capacity of 25-60 kN
- 1- or 2-channel safety system up to performance level "e" (EN ISO 13849-1)
- Max. coupled height of 96 mm
- Change repeatability of 0.03 mm
- Change cycle < 2.5 s

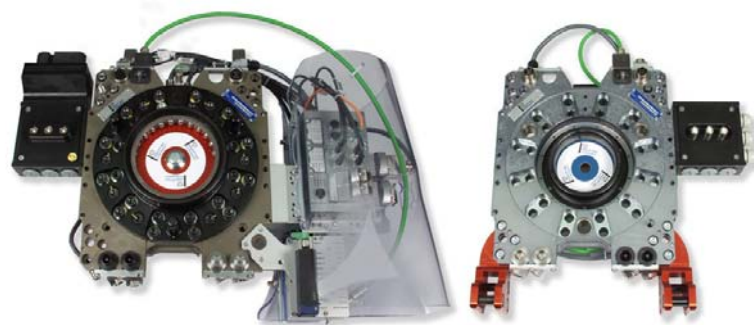
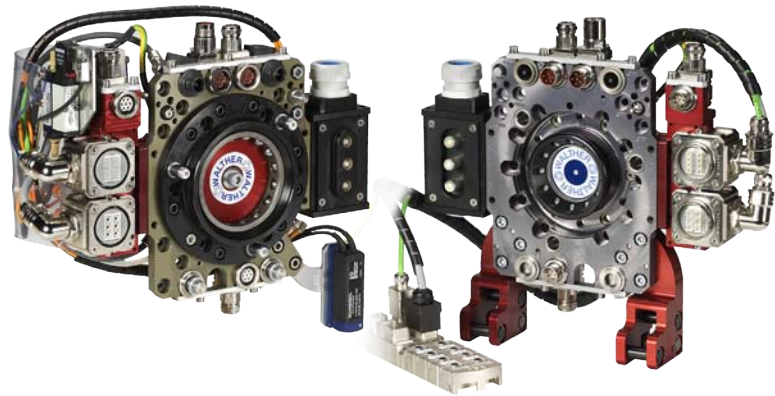





## Tool changing systems for robots

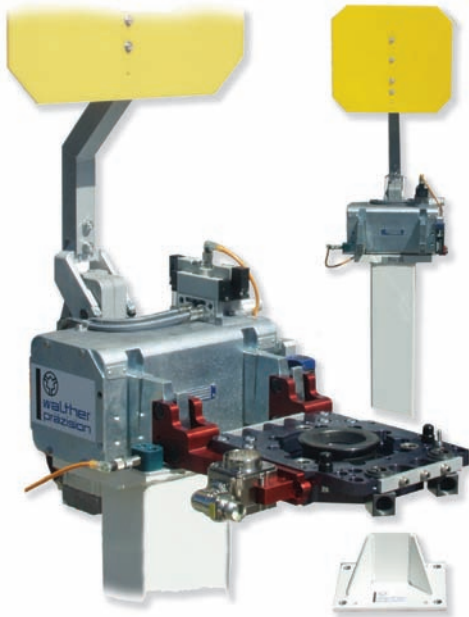

### Tool parking stations for TOOLmaster TM 500, TM 800, TM 1000

Various tool parking stations are available for a wide variety of TOOLmaster toolsets that allow for quick and safe tool parking. Just like the tool changer, the tool parking station is constructed modularly and can be assembled from individual components according to customer specifications.

- Equalisation tolerance of the tool holder  $\pm 0.5$  mm
- Cover protects parked tools from dirt ingress (such a welding spatter)
- Initiators monitor the position of the cover and tool in the parking station
- Horizontal and vertical parking
- Different stand heights
- Double or individual parking

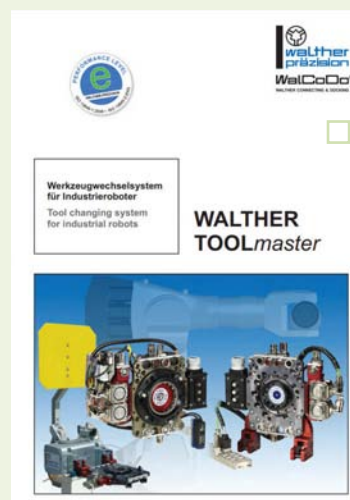

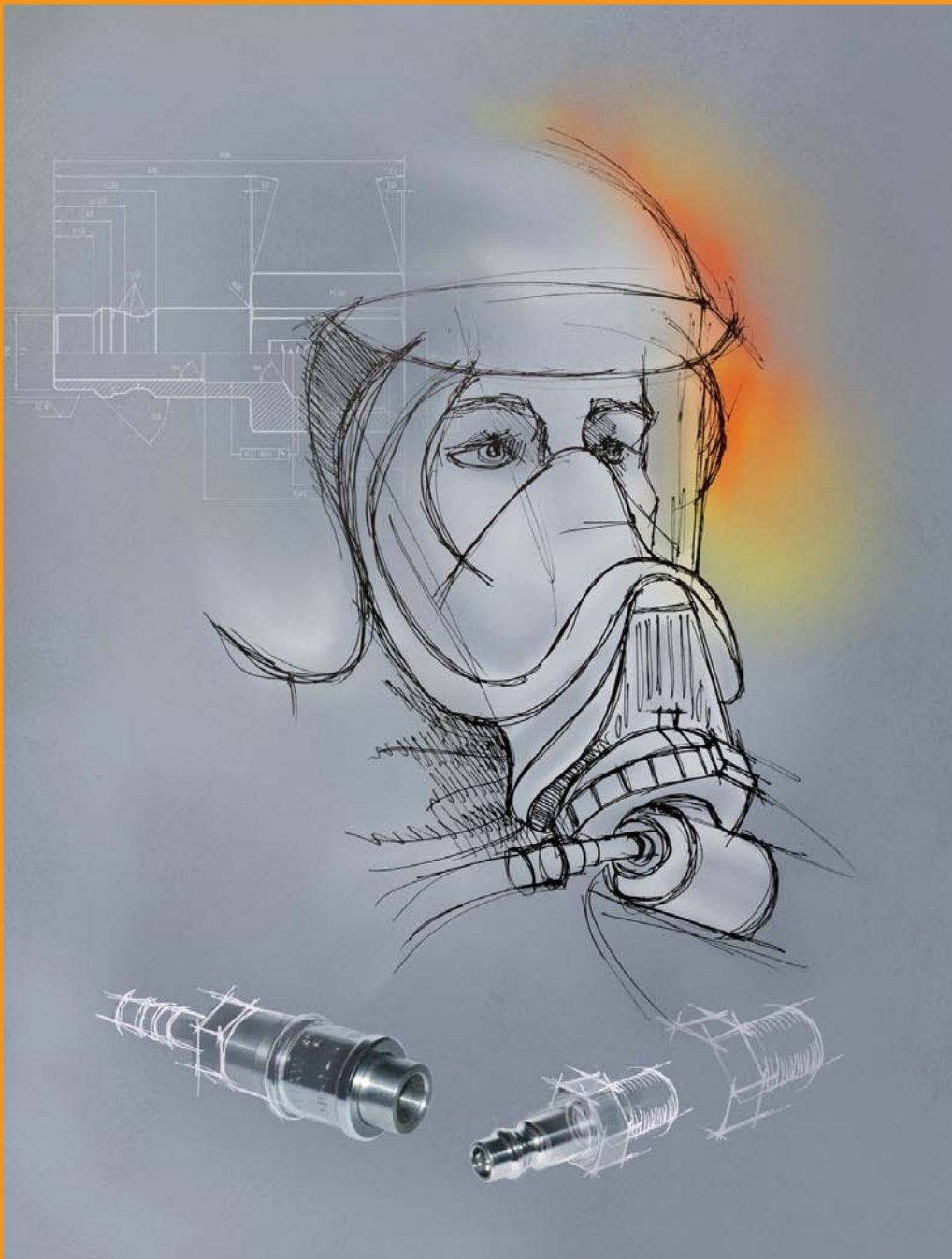

Diverse accessories such as protection elements in simple or pressure-tight designs, airguns, manifolds and hose lines complement our range and partly ensure the increased longevity of our high-quality products!



## Protection elements, hose lines and other accessories

Connecting and reducing adaptors	170
Reinforced hose lines	172
Blow-out units, pistols and nozzles	176
Multi-way manifolds	182
Protection elements	184
Pressure-tight protection elements	186
Universal protection elements	192

We would be happy to provide you with support and advice. Please contact us:



+49 (0) 2129 / 567-405





tk@walther-praezision.de



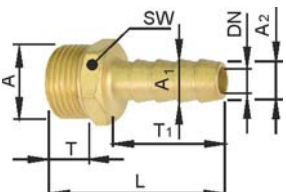

## Connecting and reducing adaptors

### Design chart

Design	Delivery	Technical features
B61		Connecting adaptors made of brass, passivated
B62		Reducing connector made of polyacetal resin (POM)
B63		Connecting adaptors made of polyacetal resin (POM)

Adaptors for connecting to coupling systems, resp. customer-sided structures. When connecting, the proper alignment and the observance of the operating pressures shall be ensured, in consideration of the end connections.

### Features chart

	Product features	Materials
Standard		40 = Polyacetal (POM) grey 45 = Polyacetal (POM) white 46 = Polyacetal (POM) black 21 = Brass passivated
Optional		11 = Steel zinc plated

Suitable coupling fittings can be found in the section Quick coupling systems up to 110 bar under KL series.



## Connecting and reducing adaptors

For example, a complete part number looks like this:  
**5-AN-00-SL025-WR048-Material**

### Product chart

Nominal bore NB	Design	A	A1	A2	L	SW	T	T1	Weight	Base material	Material-neutral part number
4	B61	BSPP 1/8"	6	7.5	38	11	8	25	10	Brass	5-AN-00-SL006-WR010-..
4	B61	BSPP 1/4"	6	7.5	39	14	9	25	15	Brass	5-AN-00-SL006-WR013-..
4	B61	BSPP 3/8"	6	7.5	39	17	9	25	21	Brass	5-AN-00-SL006-WR017-..
4	B61	BSPP 1/2"	6	7.5	42	22	11	25	32	Brass	5-AN-00-SL006-WR021-..
6	B61	BSPP 1/8"	8	9.5	38	11	8	25	12	Brass	5-AN-00-SL009-WR010-..
6	B61	BSPP 1/4"	8	9.5	39	14	9	25	19	Brass	5-AN-00-SL009-WR013-..
6	B61	BSPP 3/8"	8	9.5	39	17	9	25	24	Brass	5-AN-00-SL009-WR017-..
6	B61	BSPP 1/2"	8	9.5	42	22	11	25	34	Brass	5-AN-00-SL009-WR021-..
7	B61	BSPP 1/4"	10	11.5	39	14	9	25	22	Brass	5-AN-00-SL011-WR013-..
7	B61	BSPP 3/8"	10	11.5	39	17	9	25	27	Brass	5-AN-00-SL011-WR017-..
7	B61	BSPP 1/2"	10	11.5	42	22	11	25	39	Brass	5-AN-00-SL011-WR021-..
10	B61	BSPP 1/4"	13	14.5	44	17	9	30	30	Brass	5-AN-00-SL013-WR013-..
10	B61	BSPP 3/8"	13	14.2	44	17	9	30	29	Brass	5-AN-00-SL013-WR017-..
10	B61	BSPP 1/2"	13	14.2	47	22	11	30	40	Brass	5-AN-00-SL013-WR021-..
12	B61	BSPP 1/2"	16	17.5	47	22	11	30	50	Brass	5-AN-00-SL016-WR021-..
25	B62	BSPP 1 1/2"	G 1		30.5	60	18		73	POM	5-AN-00-XX008-WR533-..
8	B63	BSPP 1/2"	13	14	52.5	24	14.5	30	10	POM	5-AN-00-SL013-WR021-..
19	B63	BSPP 1 1/2"	25	27	78	50	18	45	63	POM	5-AN-00-SL025-WR048-..
22	B63	BSPP 1 1/2"	32	34	77	50	18	44	101	POM	5-AN-00-SL032-WR048-..
32	B63	BSPP 1 1/2"	42	45	94	50	18	61	99	POM	5-AN-00-SL042-XX004-..



Nominal bore NB [mm] A - Connection A1 - Connection [mm] A2 - Connection [mm] L - Length [mm] SW - Wrench size [mm] T / T1 - Thread length [mm] Weight [g]





## Reinforced hose lines

### Design chart

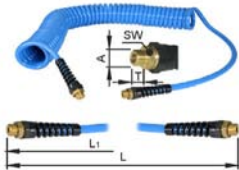
Design	Delivery	Technical features
B41		Hydraulic high pressure hose version: Self-sealing coupling 02-003-0 + self-sealing adaptor 02-003-2
B42		Hydraulic high pressure hose version: Self-sealing coupling 02-003-0 + connecting adaptor
B43		Hydraulic high pressure hose version: Self-sealing adaptor 02-003-2 + connecting adaptor
B44		<p>WALPRESTA polyurethane spiral hoses are available in nominal bores of 6.5 to 11 mm and in lengths of 4.5 to 10 m. They combine the reliability of our compressed air couplings with the special properties of the high-grade polyurethane of the spiral hose.</p> <ul style="list-style-type: none"> <li>• High flow rate at permissible operating pressures of up to 10 bar (at room temperature)</li> <li>• Large operating range with a low space requirement due to a small coil diameter</li> <li>• Elastic, flexible and bend-resistant due to the use of special polyurethane and bend protection</li> <li>• High abrasion, pressure and wear resistance</li> <li>• Extremely durable recoil force of the spiral</li> <li>• Completely silicone-free; contains no plasticizers or heavy metals; benzene-, oil- and antifreeze-resistant</li> <li>• Straight outgoing feeders 100 and 500 mm</li> </ul>



## Reinforced hose lines

### Features chart

	Product features	Materials	Seals	Additional options
Standard	- B41 only usable with both sides self-sealing	<b>95020 / 95021</b> Hose: PA = Polyamide End connection: 12 = Steel oil burnished  <b>SW</b> Hose: PU = Polyurethane End connection: Brass	1 = NBR 2 = FKM 4 = EPDM	On request (see pages 19-20)
Optional		<b>95020 / 95021</b> End connection: 13 = Steel chemically nickel plated		

The integrated coupling fittings type 02-003 with the technical details can be found in the section Mini-couplings up to 500 bar.

For example, a complete part number looks like this:  
**95020-0-LG020-Material-Seal-Additional options**

### Product chart

Nominal bore NB	Design	A	L	L1	L2	SW	T	Weight	Base material	Material-neutral part number
2.5	B41	02-003-2	200	38	37.5			75	Polyamid / steel	95021-0-LG020-...-
2.5	B41	02-003-2	400	38	37.5			80	Polyamid / steel	95021-0-LG040-...-
2.5	B41	02-003-2	630	38	37.5			80	Polyamid / steel	95021-0-LG063-...-
2.5	B41	02-003-2	800	38	37.5			85	Polyamid / steel	95021-0-LG080-...-
2.5	B41	02-003-2	1,000	38	37.5			90	Polyamid / steel	95021-0-LG100-...-
8.9	B44	BSPP 1/2"	7,500	6,000		27	15	1,800	Polyurethane / Brass	SW-011-9-WR021-PU-.-Z06

Nominal bore NB [mm] A - Connection L/L1/L2- Length [mm] SW - Wrench size [mm] T - Thread length [mm] Weight [g]



## Reinforced hose lines

### Product chart

Nominal bore NB	Design	A	L	L1	L2	SW	T	Weight	Base material	Material-neutral part number
6.5	B44	BSPP 1/4"	4,500	3,000		17	14	460	Polyurethane / Brass	SW-007-9-WR013-PU--Z03
6.5	B44	BSPP 1/4"	7,500	6,000		17	14	650	Polyurethane / Brass	SW-007-9-WR013-PU--Z06
8	B44	BSPP 3/8"	4,500	3,000		22	12	610	Polyurethane / Brass	SW-008-9-WR017-PU--Z03
8	B44	BSPP 3/8"	7,500	6,000		22	12	980	Polyurethane / Brass	SW-008-9-WR017-PU--Z06
8	B44	BSPP 3/8"	10,000	8,000		22	12	1,110	Polyurethane / Brass	SW-008-9-WR017-PU--Z08
8.9	B44	BSPP 3/8"	4,500	3,000		22	12	630	Polyurethane / Brass	SW-009-9-WR017-PU--Z03
8.9	B44	BSPP 3/8"	7,500	6,000		22	12	1,040	Polyurethane / Brass	SW-009-9-WR017-PU--Z06
8.9	B44	BSPP 3/8"	10,000	8,000		22	12	1,220	Polyurethane / Brass	SW-009-9-WR017-PU--Z08
2.5	B42	M 10 x 1	200	38	19	11	11	60	Polyamid / steel	95020-0-LG020-...-
2.5	B42	M 10 x 1	400	38	19	11	11	65	Polyamid / steel	95020-0-LG040-...-
2.5	B42	M 10 x 1	630	38	19	11	11	65	Polyamid / steel	95020-0-LG063-...-
2.5	B42	M 10 x 1	800	38	19	11	11	70	Polyamid / steel	95020-0-LG080-...-
2.5	B42	M 10 x 1	1,000	38	19	11	11	75	Polyamid / steel	95020-0-LG100-...-
2.5	B43	M 10 x 1	200	37.5	19	11	11	44	Polyamid / steel	95020-2-LG020-...-
2.5	B43	M 10 x 1	400	37.5	19	11	11	48	Polyamid / steel	95020-2-LG040-...-
2.5	B43	M 10 x 1	630	37.5	19	11	11	50	Polyamid / steel	95020-2-LG063-...-
2.5	B43	M 10 x 1	800	37.5	19	11	11	55	Polyamid / steel	95020-2-LG080-...-
2.5	B43	M 10 x 1	1,000	37.5	19	11	11	60	Polyamid / steel	95020-2-LG100-...-







Nominal bore NB [mm] A - Connection L/L1/L2- Length [mm] SW - Wrench size [mm] T - Thread length [mm] Weight [g]





## Blow-out units, pistols and nozzles

### Design chart

Design	Delivery	Technical features
B51		Blast pipe, flexible with thru-type adaptor connection
B52		Blast pipe, flexible with hose connection
B53		Lever air blower with thru-type adaptor connection 2 mm nozzle bore. Other bore holes of 5 mm, 6 mm and 8 mm are available according to order details.
B54		Lever air blower with hose connection 2 mm nozzle bore. Other bore holes of 5 mm, 6 mm and 8 mm are available according to order details.
B55		Lever air blower with thru-type adaptor connection 2 mm nozzle bore. Other bore holes of 2.5 mm, 3 mm, 4 mm and 5 mm are available according to order details.
B56		Lever air blower with hose connection 2 mm nozzle bore. Other bore holes of 2.5 mm, 3 mm, 4 mm and 5 mm are available according to order details.

Pressurized air gun for blow-out and cleaning of manufacturing parts and machines. The ergonomic shape allows a simple cleaning, even places which are difficult to access. Several accessories available. The relevant Health and Safety Regulations (HSR) are to be observed and wearing an according safety equipment is required.





## Blow-out units, pistols and nozzles

### Design chart

Design	Delivery	Technical features
B57		1.5 mm nozzle bore connection: LP-006-1 or LP-007-1 • robust and reliable • quiet • easily regulated compressed air volume • long service life
B58		1.5 mm nozzle bore hose connection of 6 mm to 13 mm • robust and reliable • quiet • easily regulated compressed air volume • long service life
B59		Compatible with B57 and B58 For targeted blowing out of hard-to-access places, air consumption like that of regular nozzles
B510		Compatible with B57 and B58 A conical air jacket is located around the blowing jet to prevent stirred up particles from bouncing back.
B511		Compatible with B57 and B58 Muffling nozzles considerably reduce the noise level without lowering the blowing force. The air consumption is therefore about 50% higher than with the regular nozzle.
B512		Compatible with B57 and B58 These nozzles increase the volume of blast air by 3- or 4-fold through air intake. The full jet is especially suitable for blowing off large areas (such as dry areas). The air consumption is about the same as with the muffling nozzle.

Pressurized air gun for blow-out and cleaning of manufacturing parts and machines. The ergonomic shape allows a simple cleaning, even places which are difficult to access. Several accessories available. The relevant Health and Safety Regulations (HSR) are to be observed and wearing an according safety equipment is required.



## Blow-out units, pistols and nozzles

### Design chart

Design	Delivery	Technical features
B513		Compatible with B57 and B58 70 mm Ø protection shield made of plastic to protect the eyes from rebounding solid particles (trade association recommendation)

Pressurized air gun for blow-out and cleaning of manufacturing parts and machines. The ergonomic shape allows a simple cleaning, even places which are difficult to access. Several accessories available. The relevant Health and Safety Regulations (HSR) are to be observed and wearing an according safety equipment is required.

### Features chart

	Product features	Materials
Standard		<p><b>95000</b> 74 = Soft PVC grey</p> <p><b>95001 / 95013 / 95015</b> PA = Polyamide</p> <p><b>95002 / 95004</b> 21 = Brass passivated</p> <p><b>95003</b> Gun body: Aluminium Air blower: 1,5 mm, Brass nickel plated Extension: Brass nickel plated Plug connector (thru-type adaptor): Steel hardened, nickel plated Hose connection: Brass passivated</p> <p><b>95012 / 95014</b> 30 = Aluminium</p>
Optional		Other on request

The integral adaptor connections of types LP-006 / LP-007 and LP-012 with technical details can be found in the section Quick coupling systems up to 110 bar, LP series.



## Blow-out units, pistols and nozzles

### Product chart

Design	Material	A	D	L	T	Weight	Part number
B51	Soft PVC	LP-006-1	24	123	20	100	95000-9-ST006-74
B51	Soft PVC	LP-007-1	24	126.5	23.3	110	95000-9-ST007-74
B52	Soft PVC	9 mm	24	135	30	100	95000-9-SL009-74
B52	Soft PVC	11 mm	24	135	30	100	95000-9-SL011-74
B52	Soft PVC	13 mm	24	135	30	110	95000-9-SL013-74
B53	Polyamide	LP-006-1	33	143	20	180	95001-9-ST006-PA
B53	Polyamide	LP-007-1	33	146.5	23.3	190	95001-9-ST007-PA
B53	Polyamide	LP-012-1	33	152.5	29.5	220	95001-9-ST012-PA
B54	Polyamide	9 mm	33	153	30	180	95001-9-SL009-PA
B54	Polyamide	11 mm	33	153	30	180	95001-9-SL011-PA
B54	Polyamide	13 mm	33	153	30	190	95001-9-SL013-PA
B54	Polyamide	16 mm	33	158	35	220	95001-9-SL016-PA
B54	Polyamide	19 mm	33	158	35	220	95001-9-SL019-PA
B55	Brass passivated	LP-006-1	21	128	20	220	95002-9-ST006-21
B55	Brass passivated	LP-007-1	21	133	23.3	230	95002-9-ST007-21
B56	Brass passivated	6 mm	22	126	25	200	95002-9-SL006-21
B56	Brass passivated	9 mm	22	138	30	210	95002-9-SL009-21
B56	Brass passivated	11 mm	22	138	30	220	95002-9-SL011-21
B56	Brass passivated	13 mm	22	138	30	220	95002-9-SL013-21
B57	Gun body: Aluminium Nozzel: Brass nickel plated Plug connector (thru-type adaptor): Steel hardened, zinc plated	LP-006-1		140		250	95003-9-ST006-30

A - Connection D - Diameter [mm] L - Length [mm] T - Thread length [mm] Weight [g]



## Blow-out units, pistols and nozzles

### Product chart

Design	Material	A	D	L	T	Weight	Part number
B57	Gun body: Aluminium Nozzel: Brass nickel plated Plug connector (thru-type adaptor): Steel hardened, zinc plated	LP-007-1		140		260	95003-9-ST007-30
B58	Gun body: Aluminium Nozzel: Brass nickel plated Hose connection: Brass passivated	6 mm		140	25	250	95003-9-SL006-30
B58	Gun body: Aluminium Nozzel: Brass nickel plated Hose connection: Brass passivated	9 mm		140	30	250	95003-9-SL009-30
B58	Gun body: Aluminium Nozzel: Brass nickel plated Hose connection: Brass passivated	11 mm		140	30	260	95003-9-SL011-30
B58	Gun body: Aluminium Nozzel: Brass nickel plated Hose connection: Brass passivated	13 mm		140	30	270	95003-9-SL013-30
B59	Brass nickel plated	M12 x 1.25		100		40	95004-9-LG100-21
B59	Brass nickel plated	M12 x 1.25		150		46	95004-9-LG150-21
B59	Brass nickel plated	M12 x 1.25		250		60	95004-9-LG250-21
B510	Aluminium	M12 x 1.25				6	95014
B511	Aluminium	M12 x 1.25				6	95012
B512	Polyamide	M12 x 1.25				12	95013
B513	Polyamide		70			9	95015

A - Connection D - Diameter [mm] L - Length [mm] T - Thread length [mm] Weight [g]









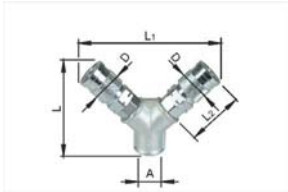
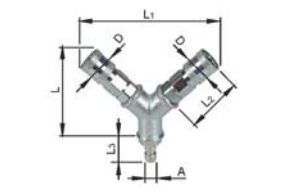

## Multi-way manifolds

### Design chart

Design	Delivery	Technical features
B71		Two-way pipe connection - Y version, including two self-sealing couplings (VK) from series LP
B72		Two-way plug connection - Y version, including thru-type adaptor (STN) and two self-sealing couplings (VK) from series LP
B73		Two-way connection - T version Please ask for technical details.
B74		Three-way connection - Cross version Please ask for technical details.

Multiway distributors can be manufactured in shape of Y-, T- and cross pieces in combination with all fittings of our standard program.



## Multi-way manifolds

### Features chart

	Product features	Materials	Seals
Standard		11 = Steel zinc plated	1 = NBR 2 = FKM 4 = EPDM
Optional		01 = Stainless steel 1.4404/1.4571 or similar 21 = Brass passivated 50 = Polyamide 11/12, grey	

For example, a complete part number looks like this:

**2R-006-0-WR517-Material-Seal**

### Product chart





Design	A	D	L	L1	L2	L3	Pipe ID	Weight	Base material	Material-neutral part number
B71	BSPP 3/8" und 2 x SSC LP-006	25	81	116	47.5		6	350	Steel	2R-006-0-WR517-...-
B71	BSPP 1/2" und 2 x SSC LP-007	30	96	140	56		7	630	Steel	2R-007-0-WR521-...-
B71	BSPP 1" und 2 x SSC LP-012	40	128	178	68		12	1,240	Steel	2R-012-0-WR533-...-
B72	TTA LP-006 und 2 x SSC LP-006	25	81	116	47.5	28.5	26	390	Steel	2S-006-0-WR517-...-

A - Connection D - Diameter [mm] L/L1/L2/L3 - Length [mm] Pipe ID [mm] Weight [g]



## Protection elements

### Design chart

Design	Delivery	Technical features
B21		Dust caps for self-sealing adaptors and thru-type adaptors with a plastic strap and ring.
B22		Dust caps for self-sealing adaptors and thru-type adaptors with a chain and ring
B23		Dust plug for self-sealing couplings and thru-type couplings with a plastic strap and ring
B24		Dust plug for self-sealing couplings and thru-type couplings with a chain and ring

The dust caps / plugs consist of a soft, flexible plastic which is resistant against the most water- and oil-containing media. Since they are stuck on top of the external and internal contours of the coupling parts, they protect the plug surfaces and internal bores of the fittings from contaminations and damage. Not suitable for pressure-tight applications.



## Protection elements

### Features chart

	Product features	Materials	Additional options
Standard	- Weather-resistant - Strain crack-resistant	71 = Soft PVC black 74 = Soft PVC grey Polyurethane (only LP-004)	KK = Chain fastening KU = Plastic strap
Optional			

### Product chart

Design	Material	For type	D	L	L1	N	Weight	Part number
B21	Soft PVC black	HP-004	23	27.5			7	HP-004-5-73-KU
B21	Soft PVC black	HP-006	30	33			11	HP-006-5-73-KU
B21	Soft PVC black	HP-010	34	38			16	HP-010-5-73-KU
B21	Soft PVC black	HP-016	41	43			20	HP-016-5-73-KU
B21	Soft PVC black	HP-020	45	45			25	HP-020-5-73-KU
B21	Polyurethane grey	LP-004 LV-004	18	23			4	LP-004-5-74-KU
B21	Soft PVC grey	LP-006	22	24			5	LP-006-5-74-KU
B21	Soft PVC grey	LP-007	25	27			7	LP-007-5-74-KU
B21	Soft PVC grey	LP-012	32	33.5			12	LP-012-5-74-KU
B21	Soft PVC grey	LP-019 MD-019	44	37.5			20	LP-019-5-74-KU
B21	Soft PVC grey	MD-006	22	24			7	MD-006-5-74-KU
B21	Soft PVC grey	MD-007	25	27			7	MD-007-5-74-KU
B21	Soft PVC grey	MD-012	32	33.5			11	MD-012-5-74-KU
B21	Soft PVC grey	SG-006 SP-006	22	24			7	SP-006-5-74-KU

D - Diameter [mm] L/L1 - Length [mm] N - Adaptor length [mm] Weight [g]



## Protection elements

### Product chart

Design	Material	For type	D	L	L1	N	Weight	Part number
B22	Soft PVC grey Chain and ring: Steel nickel plated	HP-032 LP-032 MD-032	73	76	58		65	LP-032-5-74-KK
B22	Soft PVC grey Chain and ring: Steel nickel plated	HP-050 LP-050 MD-050	114.5	110	92		110	LP-050-5-74-KK
B22	Soft PVC grey Chain and ring: Steel nickel plated	SP-009	25.5	46	31		16	SP-009-5-74-KK
B23	Soft PVC black	HP-004	20	27.5		15.5	7	HP-004-6-73-KU
B23	Soft PVC black	HP-006	30	33		17	13	HP-006-6-73-KU
B23	Soft PVC black	HP-010	34	42		22	23	HP-010-6-73-KU
B23	Soft PVC black	HP-016	41	45		25	32	HP-016-6-73-KU
B23	Soft PVC black	HP-020	45	47		27	40	HP-020-6-73-KU
B23	Soft PVC grey	LP-004 LV-004	18	24		12	5	LP-004-6-74-KU
B23	Soft PVC grey	LP-006	22	30		18	8	LP-006-6-74-KU
B23	Soft PVC grey	LP-007	25	34		18	10	LP-007-6-74-KU
B23	Soft PVC grey	LP-012	32	43		23	19	LP-012-6-74-KU
B23	Soft PVC grey	LP-019 MD-019	44	46		26	34	LP-019-6-74-KU
B23	Soft PVC grey	MD-006	22	30		18	8	MD-006-6-74-KU
B23	Soft PVC grey	MD-007	25	34		18	9	MD-007-6-74-KU
B23	Soft PVC grey	MD-012	32	43		23	19	MD-012-6-74-KU
B23	Soft PVC grey Polyurethane soft PVC grey	SG-006 SP-006	22	25		13	7	SP-006-6-74-KU
B24	Soft PVC grey Chain and ring: Steel nickel plated	HP-032 LP-032 MD-032	82	60		32	160	LP-032-6-74-KK
B24	Soft PVC grey Chain and ring: Steel nickel plated	HP-050 LP-050 MD-050	112	66		37	240	LP-050-6-74-KK
B24	Soft PVC grey Chain and ring: Steel nickel plated	SP-009	34	35		19	19	SP-009-6-74-KK

D - Diameter [mm] L/L1 - Length [mm] N - Adaptor length [mm] Weight [g]







## Pressure-tight protection elements

### Technical chart

Nominal bore [mm]	p max. permissible static [bar / psi]			Series
	Steel	Brass	Stainless steel	
	coupled	coupled	coupled	
3			64 / 928	CT
5			64 / 928	CT
7			64 / 928	CT
9			64 / 928	CT
12			64 / 928	CT
19			40 / 580	CT
6	1,000 / 14,500		345 / 5,000	HP
10	600 / 8,700		345 / 5,000	HP
16	500 / 7,250		250 / 3,625	HP
20	400 / 5,800		210 / 3,045	HP
32	300 / 4,350		210 / 3,045	HP
4		60 / 870		LP
6	100 / 1,450		90 / 1,305	LP
7	70 / 1,015		60 / 870	LP
12	60 / 870		50 / 725	LP
19	60 / 870		40 / 580	LP
32	30 / 435		30 / 435	LP
50	30 / 435		30 / 435	LP
6	200 / 2,900		100 / 1,450	MD
7	250 / 3,625		100 / 1,450	MD
12	250 / 3,625		100 / 1,450	MD
19	250 / 3,625		50 / 725	MD
32	200 / 2,900		40 / 580	MD
50	100 / 1,450		30 / 435	MD
6	120 / 1,740		100 / 1,450	SP

The pressure values are applicable at a temperature of 20°C. Please inquire about other temperature ranges.

Stated maximum permissible operating pressures (p max. permissible static) only apply to materials specified by us and to operation with group II media according to directive 2014/68/EU. Material combinations, optional materials, as well as other media or other temperature ranges can lead to divergent maximum permissible operating pressures and must be requested separately.

Please note that the maximum permissible operating pressure of the connection and quick coupling system must be considered when determining the plant operating pressure. Our safety instructions must be followed.



## Pressure-tight protection elements

### Design chart

Design	Delivery	Technical features
B11		Dust cap with stainless steel line for series CT self-sealing adaptors
B12		Dust plug with chain and ring for self-sealing couplings for the series HP, LP, MD and SP
B13		Dust cap with chain and ring for self-sealing adaptors and thru-type adaptors for the series HP, LP, MD and SP

### Features chart

	Product features	Materials	Seals
Standard	- Can optionally be used as a parking station	<b>CT</b> N2 = Stainless Steel 1.4307 <b>LP / SP</b> 11 = Steel zinc plated / nickel plated 21 = Brass passivated <b>MD</b> 12 = Black nickel plated 19 = Steel zinc plated / black nickel plated 21 = Brass passivated <b>HP</b> 12 = Steel oil burnished (Locking sleeve: Steel oil burnished; Coupling housing: black nickel plated) nipple: Black nickel plated	1 = NBR 2 = FKM 4 = EPDM <b>CT</b> 2 = FKM 4 = EPDM
Optional		13 = Steel chemically nickel plated	



## Pressure-tight protection elements

For example, a complete part number looks like this:

**SP-006-5-Material-Seal**

### Product chart

Design	Base material	For type	D	L	N	Weight	Material-neutral part number
B11	Stainless Steel	CT-003	21.4	30.9		47	CT-003-5-...
B11	Stainless Steel	CT-005	26.2	31.9		75	CT-005-5-...
B11	Stainless Steel	CT-007	32.7	37.6		186	CT-007-5-...
B11	Stainless Steel	CT-009	35.4	45.4		118	CT-009-5-...
B11	Stainless Steel	CT-012	40	44.9		205	CT-012-5-...
B11	Stainless Steel	CT-019	58	60.3		507	CT-019-5-...
B12	Black nickel plated	HP-006	34	52		250	HP-006-5-...
B12	Black nickel plated	HP-010	46	60		400	HP-010-5-...
B12	Black nickel plated	HP-016	56	73		870	HP-016-5-...
B12	Black nickel plated	HP-020	62	73		1,000	HP-020-5-...
B12	Black nickel plated	HP-032	90	94		2,650	HP-032-5-...
B12	Steel zinc plated / nickel plated	LP-006	25	45		120	LP-006-5-...
B12	Steel zinc plated / nickel plated	LP-007	30	52		200	LP-007-5-...
B12	Steel zinc plated / nickel plated	LP-012	40	58		340	LP-012-5-...
B12	Steel zinc plated / nickel plated	LP-019	54	64		610	LP-019-5-...
B12	Steel zinc plated / nickel plated	LP-032	82	88		2,150	LP-032-5-...
B12	Steel zinc plated / nickel plated	LP-050	112	103		4,400	LP-050-5-...
B12	Steel zinc plated / black nickel plated	MD-006	25	45		120	MD-006-5-...
B12	Steel zinc plated / black nickel plated	MD-007	30	52		200	MD-007-5-...
B12	Steel zinc plated / black nickel plated	MD-012	40	58		350	MD-012-5-...
B12	Steel zinc plated / black nickel plated	MD-019	54	64		610	MD-019-5-...

D - Diameter [mm] L - Length [mm] N - Adaptor length [mm] Weight [g]



## Pressure-tight protection elements

### Product chart

Design	Base material	For type	D	L	N	Weight	Material-neutral part number
B12	Steel zinc plated / black nickel plated	MD-032	82	88		2,150	MD-032-5-...
B12	Steel zinc plated / black nickel plated	MD-050	112	103		4,400	MD-050-5-...
B12	Steel zinc plated / nickel plated	SP-006	22	46		100	SP-006-5-...
B13	Black nickel plated	HP-006	30	48	30.5	100	HP-006-6-..
B13	Black nickel plated	HP-010	40	50	36	150	HP-010-6-..
B13	Black nickel plated	HP-016	40	58	41	210	HP-016-6-..
B13	Black nickel plated	HP-020	40	60	43	250	HP-020-6-..
B13	Black nickel plated	HP-032	62	71.5	49.5	570	HP-032-6-..
B13	Brass passivated	LP-004	18	28	16	36	LP-004-6-..
B13	Steel zinc plated / nickel plated	LP-006	25	38	20	75	LP-006-6-..
B13	Steel zinc plated / nickel plated	LP-007	25	38	23.3	70	LP-007-6-..
B13	Steel zinc plated / nickel plated	LP-012	30	44	29.5	110	LP-012-6-..
B13	Steel zinc plated / nickel plated	LP-019	40	50	32.5	200	LP-019-6-..
B13	Steel zinc plated / nickel plated	LP-032	65	58	39	580	LP-032-6-..
B13	Steel zinc plated / nickel plated	LP-050	100	66	46	1,650	LP-050-6-..
B13	Steel zinc plated / black nickel plated	MD-006	25	38	21.7	70	MD-006-6-..
B13	Steel zinc plated / black nickel plated	MD-007	25	38	25	60	MD-007-6-..
B13	Steel zinc plated / black nickel plated	MD-012	30	44	31.5	95	MD-012-6-..
B13	Steel zinc plated / black nickel plated	MD-019	40	50	35.5	200	MD-019-6-..
B13	Steel zinc plated / black nickel plated	MD-032	65	58	41	520	MD-032-6-..
B13	Steel zinc plated / black nickel plated	MD-050	100	70	50	1,630	MD-050-6-..
B13	Steel zinc plated / nickel plated	SP-006	22	33	20	60	SP-006-6-..

D - Diameter [mm] L - Length [mm] N - Adaptor length [mm] Weight [g]





## Universal protection elements

### Design chart

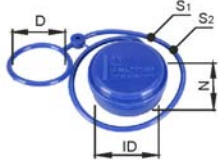
Design	Delivery	Technical features
B31		<p>The dust caps are equipped with a collar on the end that ensures a better grip.</p> <ul style="list-style-type: none"> <li>- They have a strap and can be directly fastened to coupling or adaptor housings of primary types</li> <li>- The strap can also be used on the hose or an additional chain, for example, in the case of other coupling types as an alternative means of fastening</li> </ul>

The dust caps consist of a soft, flexible polyurethane plastic (blue) which is resistant against the most water- and oil-containing media. Since they are stuck on top of the external and internal contours of the coupling parts, they protect the plug surfaces of the fittings from contaminations and damage. Due to a specific determination of the stretch measure, the caps are designed for several coupling types, but not for pressure-tight applications.

### Features chart

	Product features	Materials
Standard	<p>- These dust caps have been developed for the listed primary types, but can also be used with secondary types due to their elasticity.</p>	PUR-plastic blue
Optional		



## Universal protection elements

### Product chart

Design	Material	For type		D	ID	N	S	S1	Weight	Part number
		Primary types	Secondary types							
B31	Polyurethane blue	CT-005-0	04-005-0 KM-006-0 LP-006-0 MD-006-0 UF-006-0	17-25	28	15	175	3	12	SK-028-9-17325-AAAA-T015
B31	Polyurethane blue	CT-007-0	06-006-0 CK-G09-0 HC-G06-0 HP-006-0 LP-019-2 MD-019-2 UF-007-0-SI TE-009-0	22-28	33	17	210	3	16	SK-033-9-22328-AAAA-T017
B31	Polyurethane blue	CT-009-0	CP-006-0 HC-G16-2 LS-006-0 MD-025-2	24-30	36	17	240	4	20	SK-036-9-24430-AAAA-T017
B31	Polyurethane blue	CT-012-0	HC-G20-2 HP-032-2 KL-012-0 LP-012-0 MD-012-0 TE-012-0 UF-012-0	35-42	40	17	270	4	27	SK-040-9-35442-AAAA-T017
B31	Polyurethane blue	CP-012-0	HC-G12-0 MD-032-2	40-47	48	30	320	4	49	SK-048-9-41447-AAAA-T030
B31	Polyurethane blue	CT-019-0	HC-G16-0	47-55	58	20	350	4	49	SK-058-9-47455-AAAA-T020
B31	Polyurethane blue	CP-016-0	BF-012-0 HC-G20-0	55-60	63	32	405	4	50	SK-065-9-55460-AAAA-T032
B31	Polyurethane blue	HP-032-0 LP-032-0 LP-032-0-SI MD-032-0 MD-032-0-SI UF-032-0 UF-032-0-SI	22-032-0-Y04 22-032-2-Y04 BF-025-0 BF-050-2 EH-050-4 NA-040-0 TE-032-0	81-95	90	74	330	3.5	118	SK-090-9-80492-AAAA-T074
B31	Polyurethane blue	CT-005-2	02-003-0 06-006-2 07-003-0 22-006-1 BF-005-2 CP-006-2 HP-010-2 LP-003-0 UF-007-1-DR/ VI UF-007-2-DR/ VI	17-25	14	22	155	3	9	SL-014-9-17325-AAAA-T022

D - Diameter [mm] ID - Clamping diameter [mm] N - Internal depth [mm] S - Cord length [mm] S1 - Cord thickness [mm] Weight [g]



## Universal protection elements

### Product chart

Design	Material	For type		D	ID	N	S	S1	Weight	Part number
		Primary types	Secondary types							
B31	Polyurethane blue	CT-007-2	03-005-0 31-006-0-Y36 BF-009-2 CK-G09-2 CP-009-2 HC-G06-2 KL-012-2 LP-012-2 MD-012-2 UF-012-2-DR/ VI	17-25	18	28	180	3	12	SL-018-9-17325-AAAA-T028
B31	Polyurethane blue	CT-009-2	MD-012-2 SP-006-0	24-30	20	30	190	4	18	SL-020-9-24430-AAAA-T030
B31	Polyurethane blue	CT-012-2	04-005-0 BF-012-2 HC-G12-2 HP-016-2 KL-006-0 KM-006-0 LP-006-0 LT-006-0 MD-006-0 UF-006-0	34-42	22	30	210	4	23	SL-022-9-35442-AAAA-T030
B31	Polyurethane blue	CP-012-2	HP-016-2 LP-007-0 LP-019-2 MD-019-2 TE-016-2-Z02 TE-019-2	43-50	23	52	220	4	41	SL-023-9-43450-AAAA-T052
B31	Polyurethane blue	CP-016-2	BF-012-2 HC-G16-2 UF-019-2-DR/ VI	59-66	33	58	247	4	53	SL-030-9-59466-AAAA-T058
B31	Polyurethane blue	CT-019-2	BF-012-2 CG-G20-2 HC-G16-2 HC-G20-2 MD-025-2 TE-012-0	44-50	35	46	260	4	46	SL-035-9-44450-AAAA-T046
B31	Polyurethane blue	HP-032-2 LP-032-2 MD-032-2 UF-032-2	04-032-2 05-032-2	79-90	48	51	340	3.5	59	SL-048-9-78484-AAAA-T050

D - Diameter [mm] ID - Clamping diameter [mm] N - Internal depth [mm] S - Cord length [mm] S1 - Cord thickness [mm] Weight [g]



## Service points in Germany and internationally

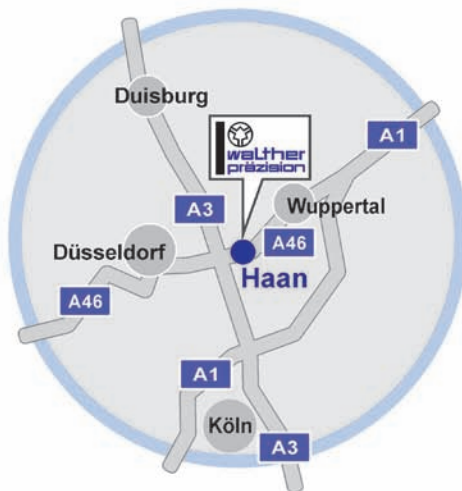
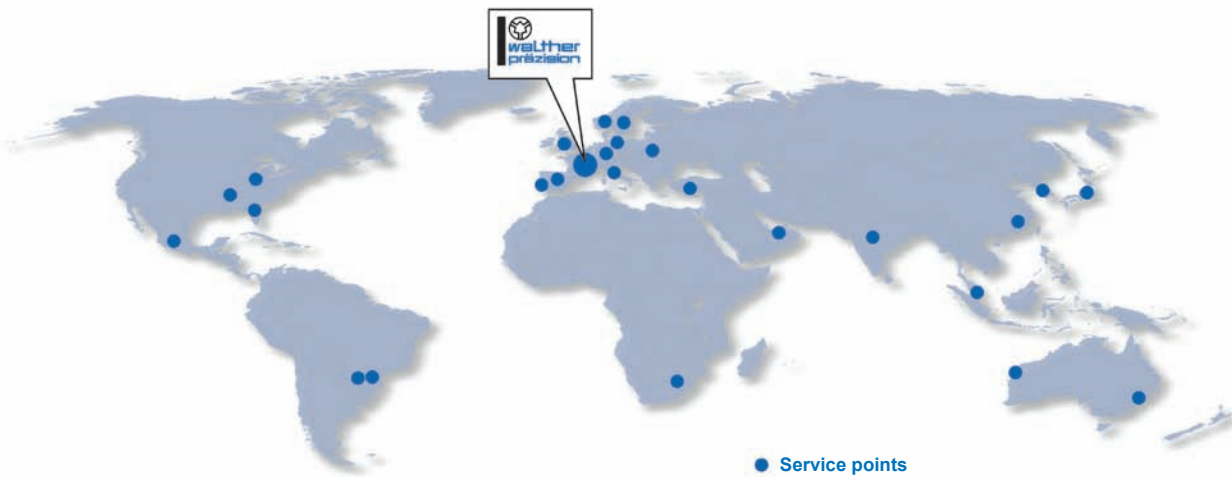

WALTHER-PRÄZISION is headquartered in Haan (NRW) on the A46 between Düsseldorf and Wuppertal.

With more than 20 service points in Germany and over 30 additional points internationally, WALTHER-PRÄZISION is always in your vicinity.

Current addresses can be found online under:  
[www.walther-praezision.de/service](http://www.walther-praezision.de/service)



## Advice

Our general terms and conditions of sale and delivery shall apply exclusively.

For any technical questions or orders, use the contact box below to get in touch with us through the proper channels.

All advice on usage and safety is subject to change (→ p. 22). Please note our extensive safety instructions advice on our website under "Service".

The details in the catalogue relate to the current production status of the products. Changes are possible with regard to technology and design.

All images, dimensions and weights are subject to change.

No liability for misprints; changes and errors excepted.

Any reproduction of this catalogue in full or in part is only permitted with the written authorisation of the publisher.

© Copyright by WALTHER-PRÄZISION  
Carl Kurt Walther GmbH & Co. KG

**Tip:**  
**Visit our website with the digital technical catalogue.**  
**There you find additional information and an e-mail-based inquiry function.**



### PUBLISHER

WALTHER-PRÄZISION  
Carl Kurt Walther GmbH & Co. KG  
Westfalenstraße 2  
42781 Haan  
GERMANY

Telephone: +49 (0) 2129 567-0  
Fax: +49 (0) 2129 567-450  
Email: [info@walther-praezision.de](mailto:info@walther-praezision.de)  
Website: [www.walther-praezision.de](http://www.walther-praezision.de)

Registered office: Haan  
Registergericht Wuppertal HRA 191

We would be happy to provide you with support and advice. Please contact us:



+49 (0) 2129 / 567-405



[tk@walther-praezision.de](mailto:tk@walther-praezision.de)







We are very proud of our connections!





© WALTHER-PRÄZISION  
• Subject to modifications, errors excepted  
• 1054 / E

# WALTHER-PRÄZISION

## Carl Kurt Walther GmbH & Co. KG

Hausadresse / Head office:

Westfalenstrasse 2  
42781 Haan, Germany

T +49 (0) 2129 / 567-0  
F +49 (0) 2129 / 567-450

Postadresse / Postal address:

PF / P.O. Box 420444  
42404 Haan, Germany

E [info@walther-praezision.de](mailto:info@walther-praezision.de)  
W [www.walther-praezision.de](http://www.walther-praezision.de)



Choose the Original  
Choose Success!



**WalCoDo**<sup>®</sup>  
WALTHER CONNECTING & DOCKING